

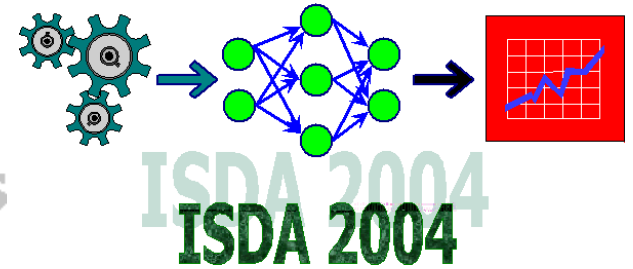

Intelligent Systems Design and Applications



Process model-based Dynamic Bayesian Networks for Prognostic

MULLER Alexandre, WEBER Philippe,

BEN SALEM Abdeljabbar

*Automatic Control Research Center of Nancy
(CRAN), CNRS UMR 7039*

*Laboratory of New Technologies
French National Institute for
Transportation and Safety Research*

*ESSTIN - 2, rue Jean Lamour
F-54519 VANDOEUVRE-LES-NANCY Cedex – FRANCE
[alexandre.muller, philippe.weber@esstin.uhp-nancy.fr]
Tél. : 33 (0)3 83 68 51 26 – Fax : 33 (0)3 83 68 50 01*

*2, Av du G^{al} Malleret Joinville
94114 Arcueil – FRANCE
[bensalem@inrets.fr]*



August 26-28, 2004, Budapest, Hungary



Content

- Introduction
- Prognosis process development
- Probabilistic model development
- Case study
- Conclusion

Introduction

- Industrial systems more and more complex
 - Competition and high demand of customers
 - Difficulties to optimise system/product performances
 - One solution : Maintenance
- Proactive maintenance strategy
- Prognosis process
 - Prognostic is defined as the ability to “predict and prevent” possible fault or system degradation before failures occur
 - Principle
 - ❖ Identify the current state of the system (at time t)
 - ❖ Predict the future state of the system (at time $t + \Delta t$)
 - ❖ (Decision making)

Prognosis process development

■ Methodology

- Process and flow based approach
 - ❖ Functional/Dysfunctional reasoning
 - ❖ Hierarchical structure
- Elaboration of the probabilistic network
 - ❖ Formalism: BN/DBN
 - ❖ Generic rules to transform the process model into a probabilistic one
- Design of the monitoring for prognosis architecture
 - ❖ DBN variables associated to indicators
 - ❖ Monitoring / Storage

Probabilistic network development (1)

- The probabilistic model goal
 - Mechanisms of inference
 - ❖ Propagation of the process degradation
 - ❖ Impact's determination of this degradation on the whole system.
- Formalism : Dynamic Bayesian Network (DBN)
 - Translation into three stages
 - ❖ Definition of nodes and states
 - ❖ Structure
 - ❖ Network parameters
 - **Acyclic structure required**

Probabilistic network development (2)

■ The cycle problem

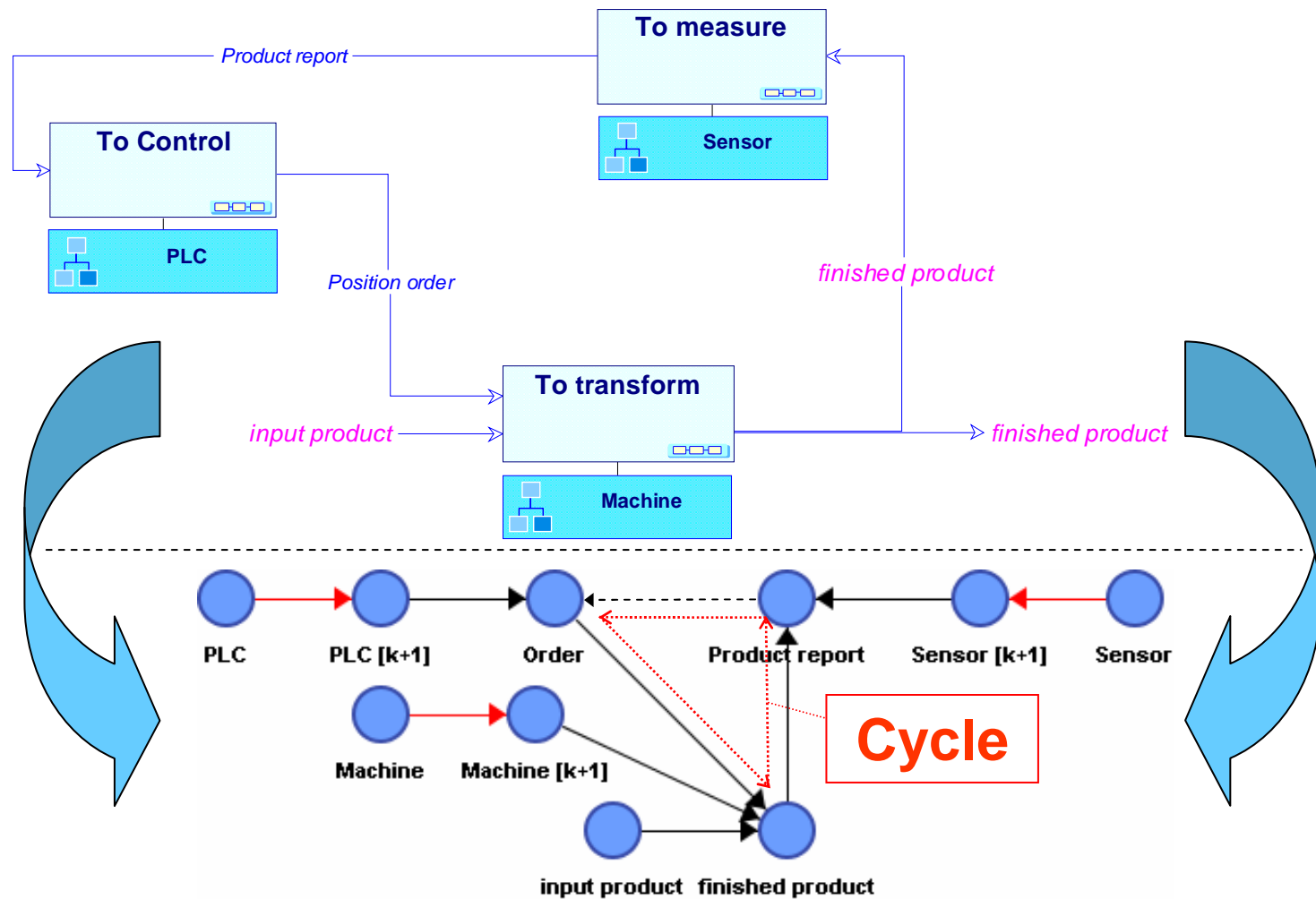

Probabilistic network development (3)

- What are the solutions to break cycles ?
 - Specifications during the design of process model
 - Set of rules to delete several edge
- First solution selected
 - The temporal dimension of flows is not always the same
 - Specification of a new flow characteristic

Probabilistic network development (4)

■ Formalization of the specification with ORM

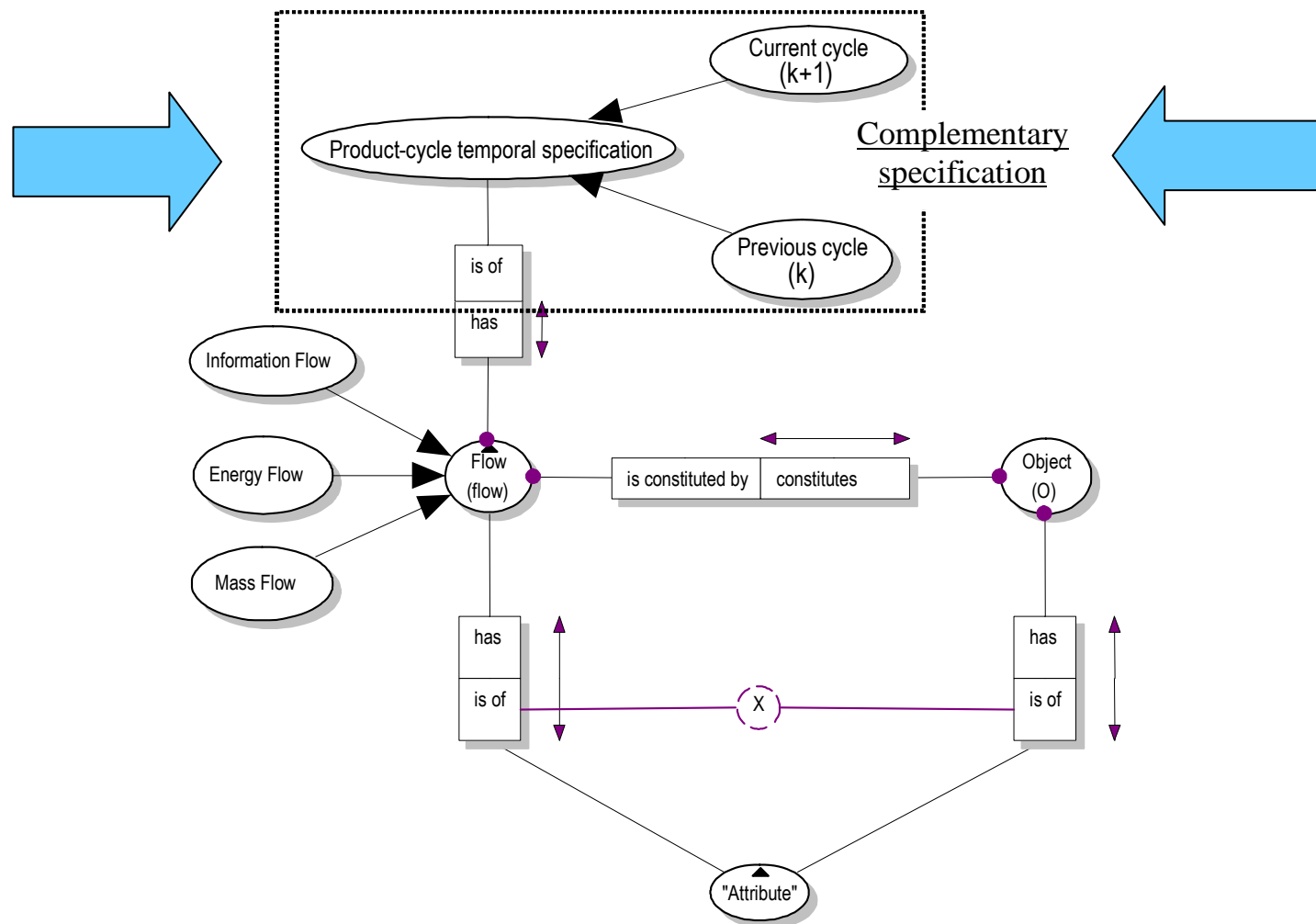

Probabilistic network development (2)

■ The translation without specification

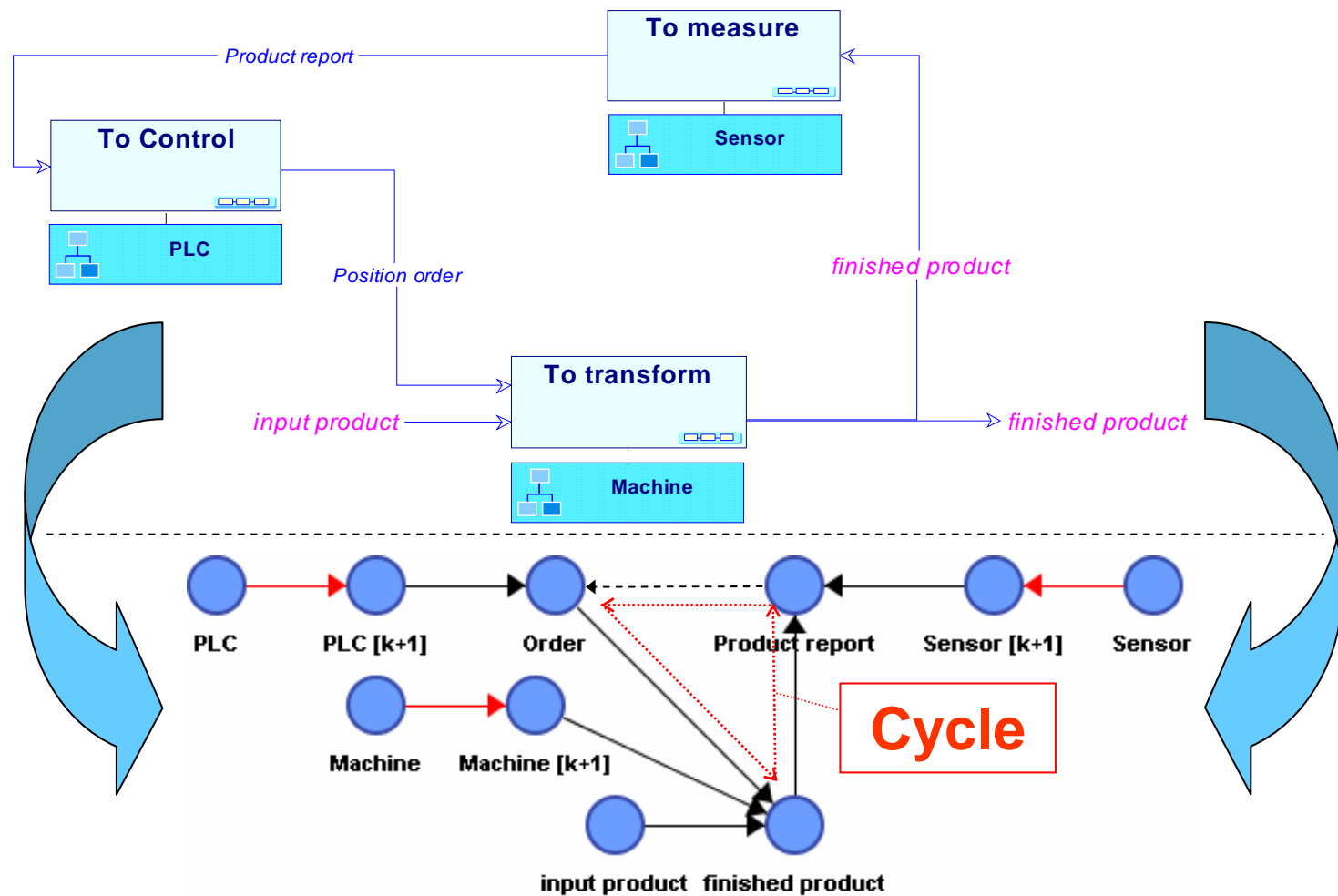

Probabilistic network development (2)

■ The translation with specification

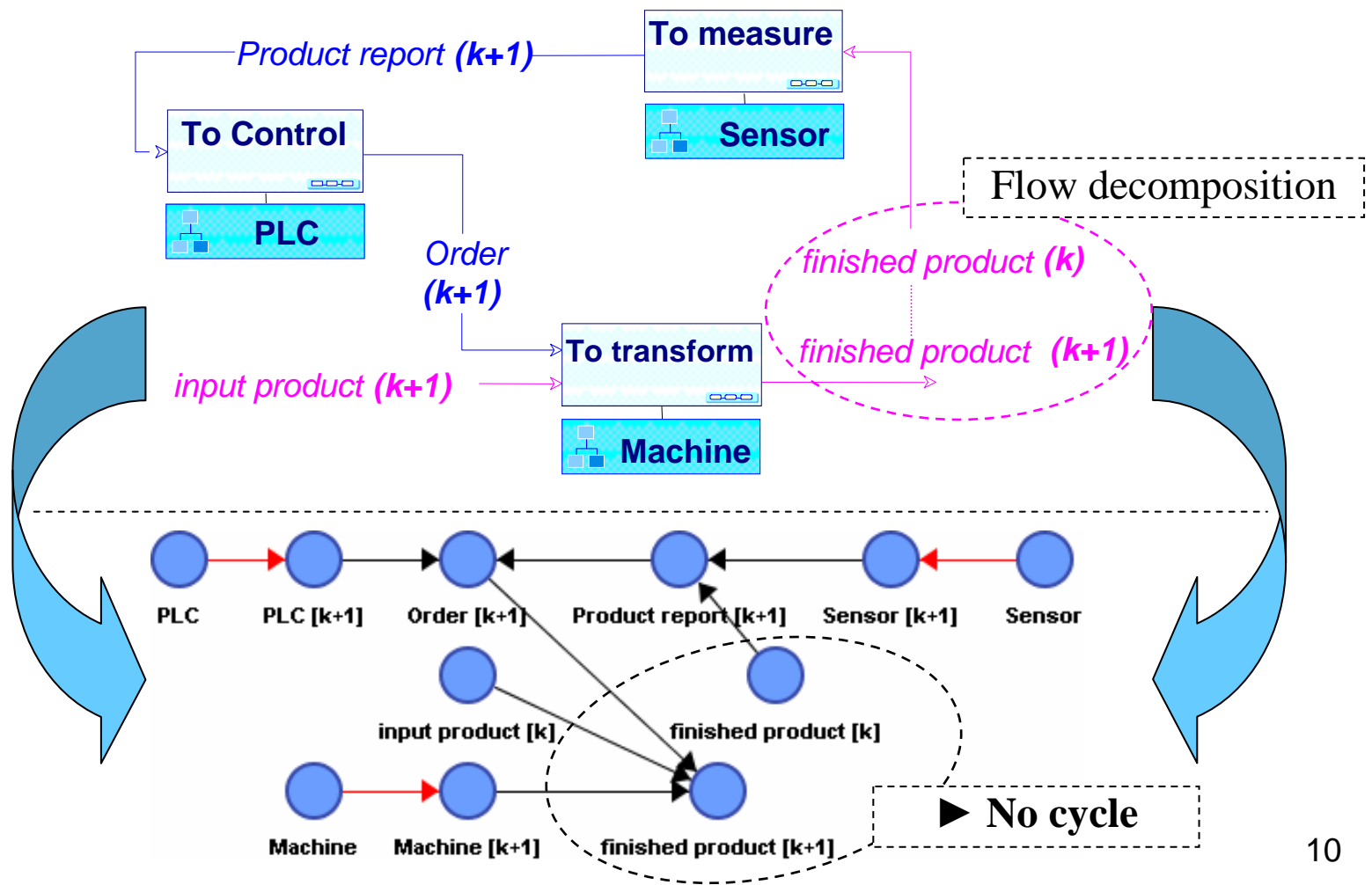



Intelligent Systems Design and Applications

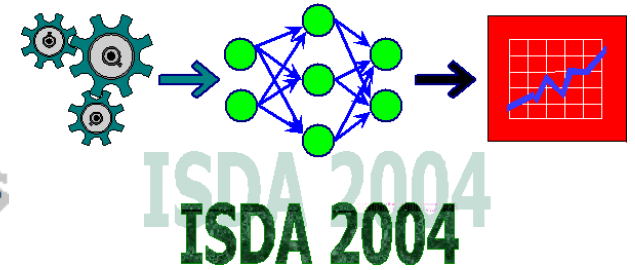

Case study



August 26-28, 2004, Budapest, Hungary



Case study

■ Water heater (Physical process)

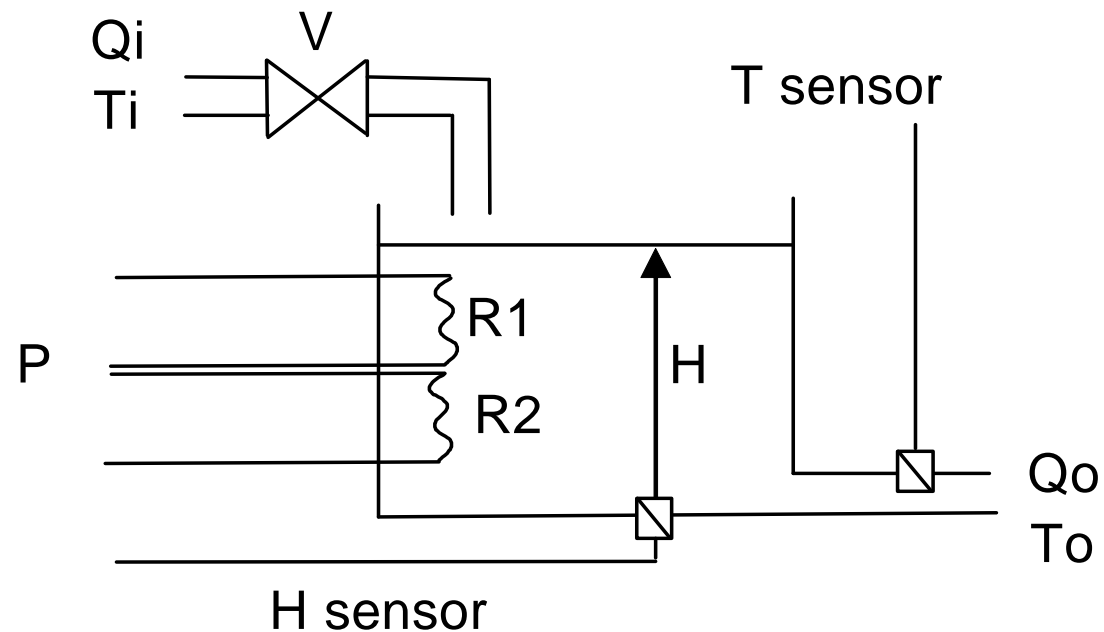

Case study

Water heater (Process model)

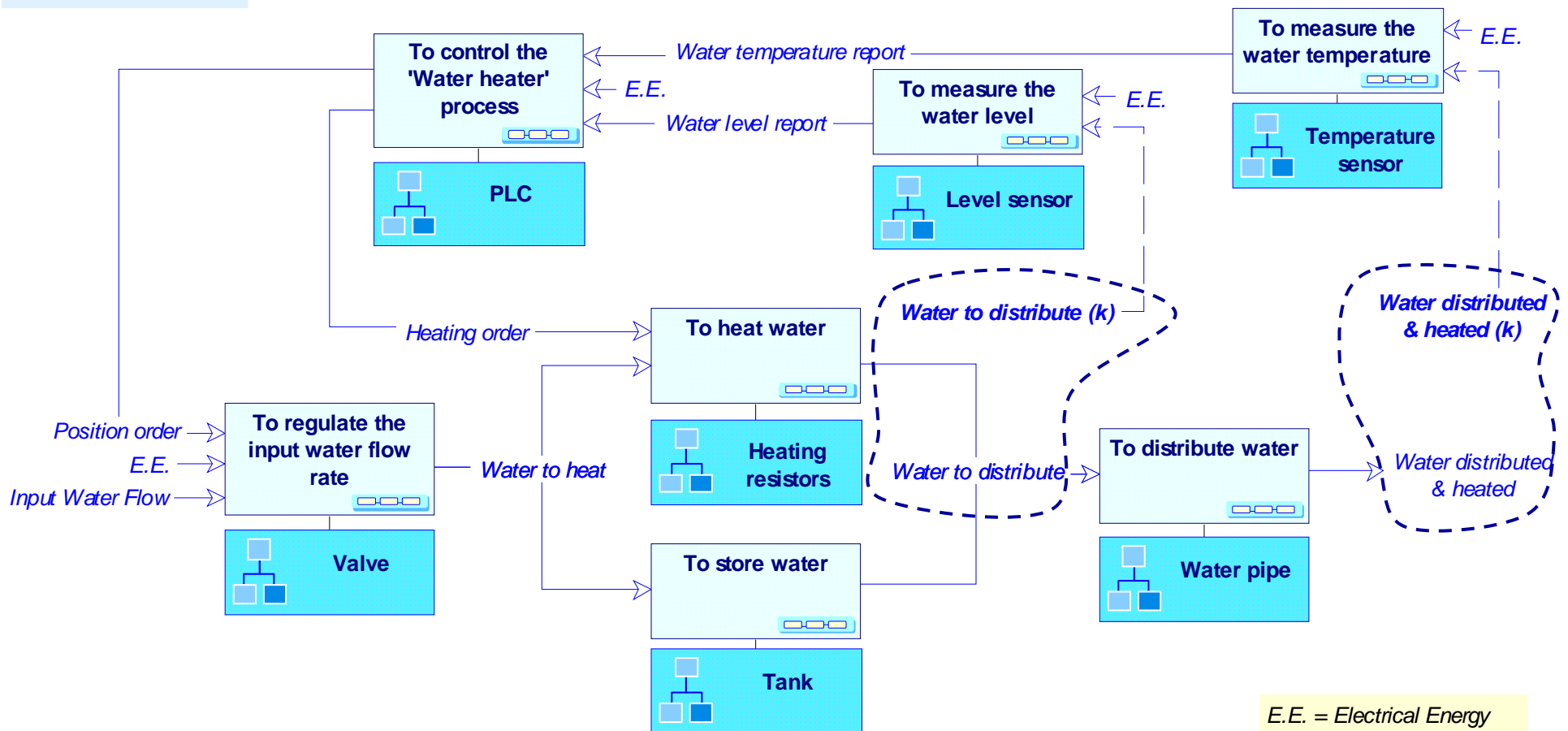

Case study

Water heater (Probabilistic model - DBN)

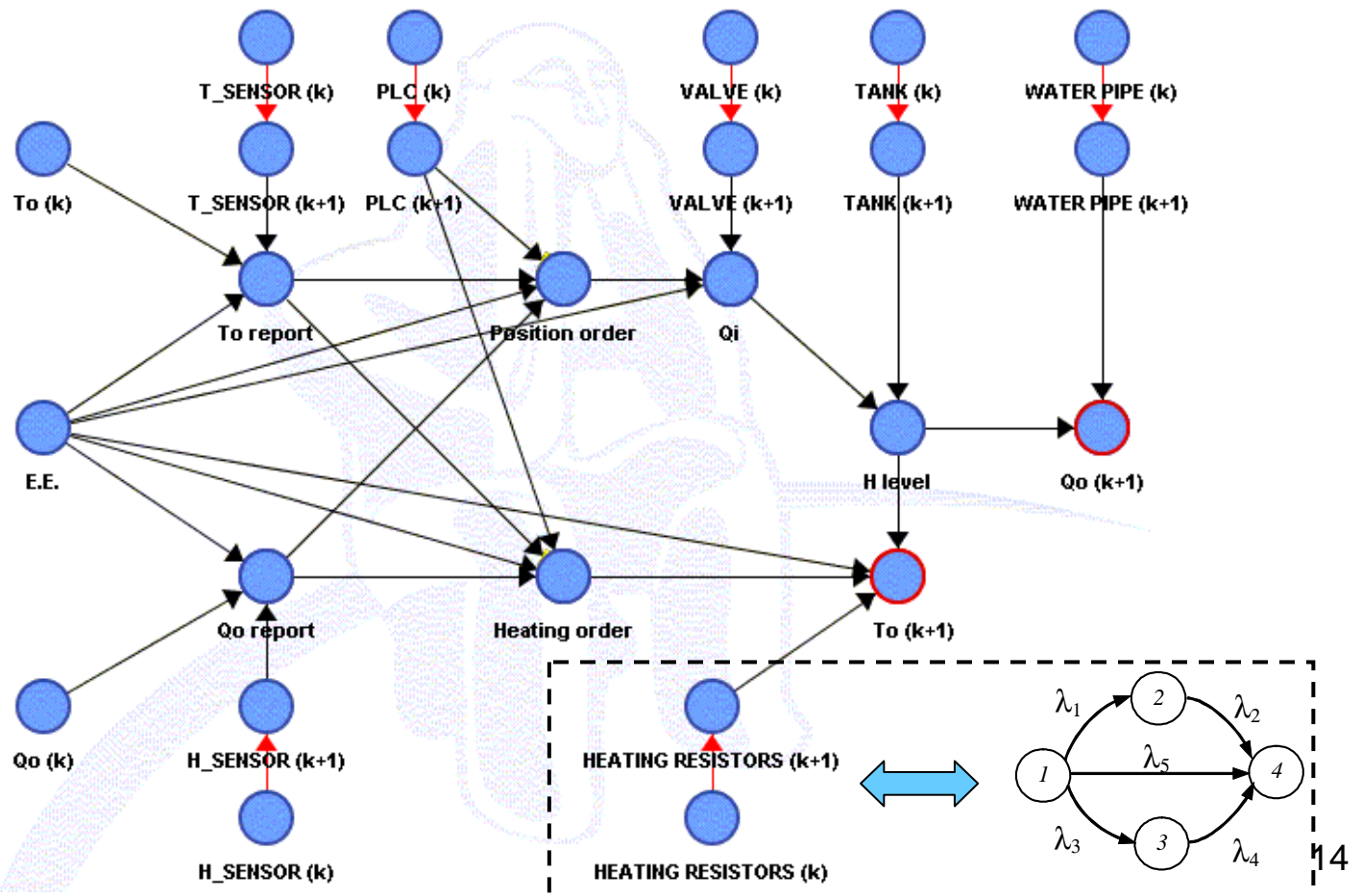

Case study

■ Water heater – Prognostic (1)

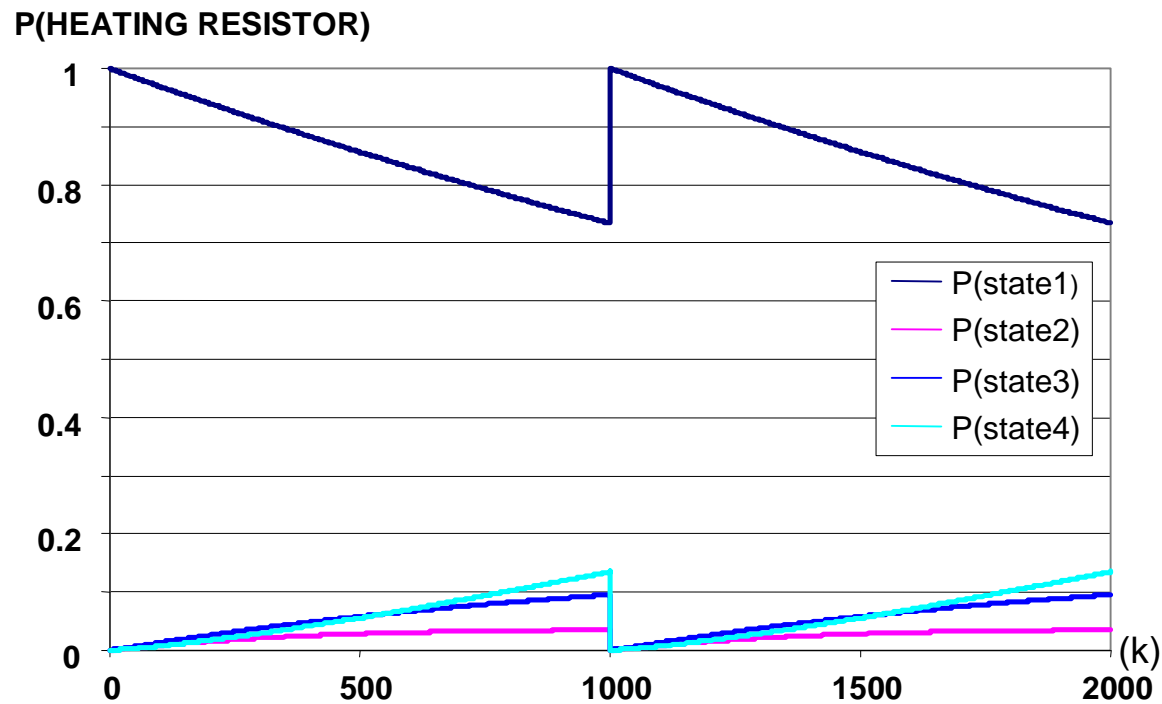

Case study

■ Water heater – Prognostic (2)

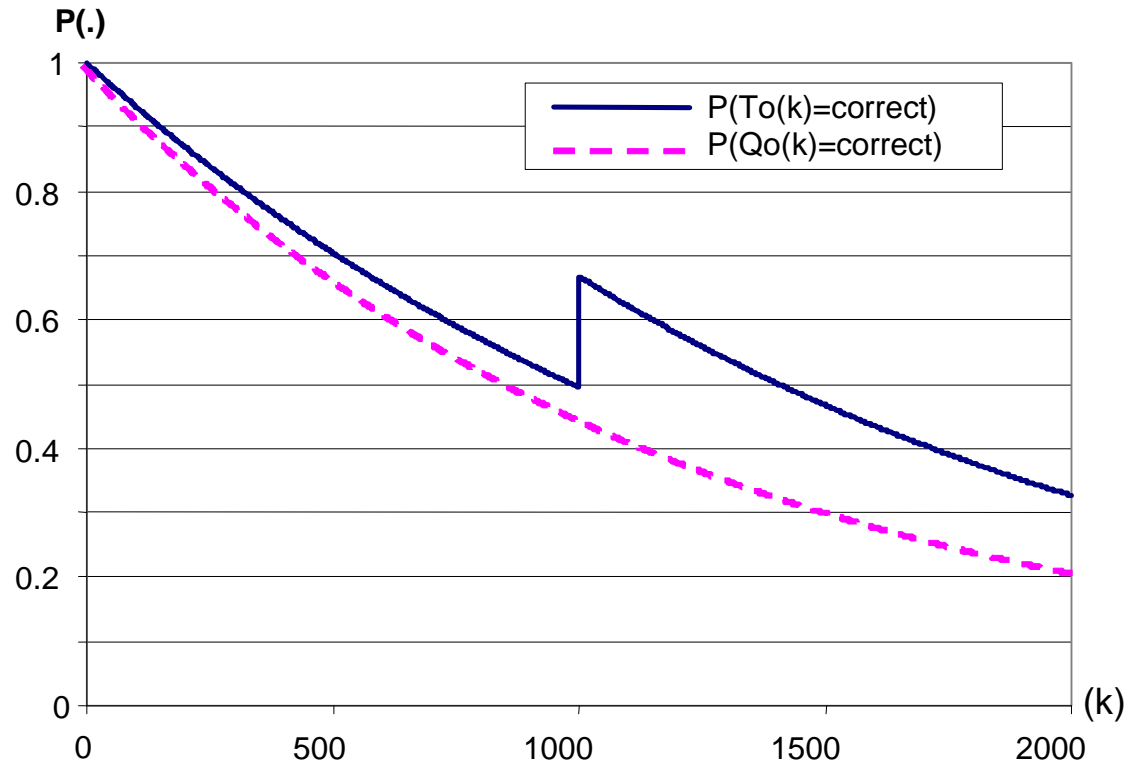

Conclusion

- The work presented in this paper explains why a methodology supporting prognosis process modelling should be formalized to take into account the characteristics and the constraints induced by its modelling tool
- Moreover, the integration of ORM specifications is in progress in our laboratory in order to develop a tool to assist the designer in developing its process & flow-based model.



Intelligent Systems Design and Applications

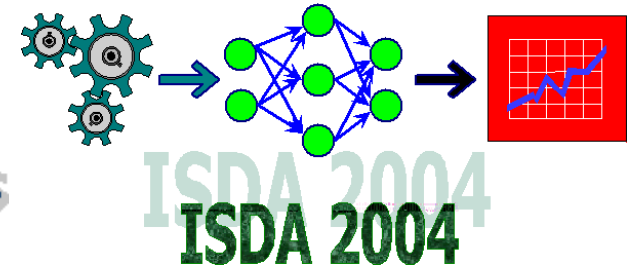

Questions



August 26-28, 2004, Budapest, Hungary

