



HAL
open science

Singularity which has no M-smoothing.

Viatcheslav Kharlamov, Stepan Orevkov, Eugenio Shustin

► **To cite this version:**

Viatcheslav Kharlamov, Stepan Orevkov, Eugenio Shustin. Singularity which has no M-smoothing.. 1998. hal-00129575

HAL Id: hal-00129575

<https://hal.science/hal-00129575>

Preprint submitted on 8 Feb 2007

HAL is a multi-disciplinary open access archive for the deposit and dissemination of scientific research documents, whether they are published or not. The documents may come from teaching and research institutions in France or abroad, or from public or private research centers.

L'archive ouverte pluridisciplinaire **HAL**, est destinée au dépôt et à la diffusion de documents scientifiques de niveau recherche, publiés ou non, émanant des établissements d'enseignement et de recherche français ou étrangers, des laboratoires publics ou privés.

SINGULARITY WHICH HAS NO M -SMOOTHING

V.M.KHARLAMOV, S.YU.OREVKOV, E.I.SHUSTIN

ABSTRACT. The Harnack bound on the number of real components of a plane real algebraic curve has a natural local version which states that the number of closed real components obtained by a perturbation of a real isolated plane curve singularity having at least one real branch is bounded by the genus of the singularity (perturbations attaining this extremal value are called M -smoothings). We show that the latter bound is not sharp for some, explicitly given, singularities.

INTRODUCTION

Topologically extremal real algebraic varieties reveal spectacular topological properties. Such a phenomenon for plane projective curves was discovered by D. Hilbert, and is stated in the first part of his 16th problem in the form of conjecture for plane curves of degree 6 with maximal number of real components. D.A. Gudkov [6] corrected the conjecture, generalized it to curves of arbitrary degree and proved it for degree 6 by the meticulous study of degenerations of curves of degree 6 (improving the so-called Hilbert-Rohn method). Another, in a sense, purely topological approach was found by V.I. Arnold; it allowed V.I. Arnold [1], V.A. Rokhlin [17] and their followers (see, for example, the surveys [7], [19], and [28]) to understand the phenomenon and to obtain a series of different related results which acquired the common name of Gudkov-Arnold-Rokhlin congruences.

It is worth to say that the notion of M -variety (M for maximal) plays a crucial role here. In the case of curves it is the usual Harnack maximality: a real plane projective curve of degree m is called maximal if it has $\frac{1}{2}(m-1)(m-2)+1$ real components. In general, in accordance with the *Smith-Thom bound*, which states that any real algebraic variety X satisfies $\beta_*(X_{\mathbf{R}}) \leq \beta_*(X_{\mathbf{C}})$ where β_* stands for

1991 *Mathematics Subject Classification*. Primary 14P25; Secondary 57M25, 57R91, 57R95.

The first and third authors were supported in part by the Minerva Center for Geometry at the Tel Aviv University. The paper was finished during the stay of the first author in Stanford university and Max-Planck-Institut für Mathematik.

the sum of the Betti numbers over $\mathbf{Z}/2$ and X_k is the set of k -points of X , a real variety X is called *maximal* if $\beta_*(X_{\mathbf{R}}) = \beta_*(X_{\mathbf{C}})$.

It happens that the problem of existence of M -varieties is not easy and yet not much is known about it. For plane curves the answer is given by Harnack's theorem [8]: maximal plane curves exist for any degree. Harnack's recursive construction of M -curves was generalized by O. Viro [24] to complete intersections in projective spaces of any dimension. Viro's recursion involves dimension of the ambient space, dimension of the complete intersection and its multidegree. For small dimensions it produces M -varieties and it is expected that this is always the case. For hypersurfaces the existence of M -varieties in any degree is proven by I. Itenberg and O. Viro [9] by means of a toric geometry version of the Viro algorithm.

This problem has local analogues (moreover, according to the Thom-Arnold principle, they are inseparable). The first nontrivial local objects are the smoothings of real isolated plane curve singularities.

Here, by a real isolated plane curve singularity, we mean a germ at $0 \in \mathbf{R}^2$ of a real analytic function f in 2 variables with finite Milnor number μ . Commonly speaking, we identify it with the germ of a curve C defined by $f = 0$, refer to a curve C in a real Milnor disc $B_{\mathbf{R}} \subset \mathbf{R}^2$ and, also, in the complex Milnor ball $B_{\mathbf{C}} \subset \mathbf{C}^2$, and denote by $C_{\mathbf{R}}$ and $C_{\mathbf{C}}$ the real and complex point sets of C .

A real analytic curve C' in a Milnor disc $B_{\mathbf{R}}$ of C is called *smoothing of C* if there exists a real analytic 1-parameter family $\{C_t\}$ of curves in $B_{\mathbf{R}}$ such that $C_0 = C$, $C' = C_t$ for some $t > 0$, and each C_t with $t \neq 0$ is nonsingular and transversal to the boundary of $B_{\mathbf{R}}$. We call such a family *smoothing out deformation of C* .

The real part $C_{\mathbf{R}}$ of a smoothing C of an isolated real plane curve singularity C consists of a finite number of smooth circles (called *ovals*) and non-closed arcs. The number of arcs does not depend on smoothing and is equal to the number $r_{\mathbf{R}}$ of real branches of C . The principal *local Harnack bound*, which is completely similar to the Harnack bound for projective curves, reads as follows: if C has at least one real branch, the number v of ovals is bounded from above by $g = \frac{1}{2}(\mu - r + 1)$, where r is the number of all, real and imaginary, branches of C ; otherwise, $v \leq g + 1$ (similarly to the global one, it can be seen as the Smith-Thom inequality). Yet in the middle 70th, V.I. Arnold [3] posed the question: *whether this local Harnack bound is sharp?*

The existence of M -smoothings (i.e., the smoothings which achieve this bound) was proven for many classes of singularities, see, e.g., [10], [13], [15], [16], [25], and [22]. In [16] it is erroneously stated that the construction given there provides M -smoothings for any real plane singularity having no imaginary branches and branches with common tangent. However, Risler's construction [16] proves the following fact: M -smoothings do exist for any unibranch singularity.

The purpose of this paper is to show that there are singularities for which *the local Harnack bound is not sharp*.

We treat one real equisingular (i.e., μ -constant) family of singularities, namely, Sirler cusp singularities (introduced by S. Carlson at Arnold's anniversary conference, Moscow, 1988; unpublished). A Sirler cusp singularity is a bouquet of any three real ordinary cusps, having distinct tangents and spread out as shown in Figure 1. By a real ordinary cusp we mean a germ $u^2 + v^3 = 0$, where u and v are real function germs vanishing at $0 \in \mathbf{R}^2$ with $du \wedge dv \neq 0$. Thus, a Sirler cusp singularity is a product of three real ordinary cusps $(u_1^2 + v_1^3)(u_2^2 + v_2^3)(u_3^2 + v_3^3) = 0$ with $v_1 + v_2 + v_3 = 0$, $dv_1 \wedge dv_2 \neq 0$, $dv_1 \wedge dv_3 \neq 0$, and $dv_2 \wedge dv_3 \neq 0$.

We prove that for all Sirler cusps singularities the local Harnack bound, which gives $v \leq g = 13$, is not sharp:

Theorem 1. *Any Sirler cusp singularity has no M -smoothings (i.e., it has no smoothing with $g = 13$ ovals).*

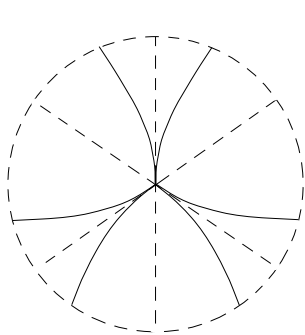

FIGURE 1

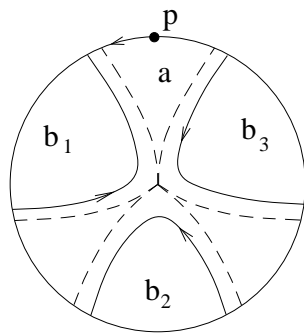

FIGURE 2

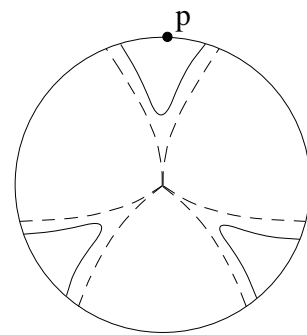

FIGURE 3

It is worth noting that the germ $(y^2 - x^3)(x^2 - y^3)((x - y)^2 - (x + y)^3) = 0$ in $B_{\mathbf{R}}$, which is topologically equivalent in $B_{\mathbf{R}}$ to Sirler cusp singularities, has, contrary to them, an M -smoothing. The same is true for a bouquet of any three ordinary

cusps contained in a half plane and having distinct tangents. Indeed, one can either apply the local version of Harnack construction (see [16]) or simplify the singular point into an ordinary 6-fold point and then replace the latter singular point by the Harnack affine sextic (see [12]).

Note also, that for the germs $(y^2 - x^3)(x^2 - y^3)(x^2 + ky^3) = 0$, $k > 0$ which are degenerations of both the Sirler cusp singularities and the germ in the above remark, there is an M -smoothing at least for some values of k . It would be interesting to study the space of singularities which have M -smoothings.

The paper is organized as follows. In Section 1 we formulate and prove some general geometric properties of smoothings (similar to properties of real algebraic curves), and derive some preliminary prohibitions on M -smoothings C' of a Sirler cusp singularity C . We start from an application of an improved local Harnack bound which takes into account how the boundary of $C_{\mathbf{R}}$ is filled by the non-closed arcs of $C'_{\mathbf{R}}$. It implies, in particular, that the non-closed arcs in $C'_{\mathbf{R}}$ should be arranged as is shown in Figure 2; it is this arrangement, which is then considered throughout the paper. Afterwards, in Section 1, we associate with C' a 4-dimensional manifold Y with an involution $\text{Conj} : Y \rightarrow Y$. This manifold is glued from two double coverings of $B_{\mathbf{C}}$: one ramified in C , the other in C' ; Conj is induced by the ordinary complex conjugation. Applying traditional tools (like Bézout's theorem, complex orientations, and congruences and bounds for the inertia indices of Conj_* acting on the quadratic form of Y) to (Y, Conj) , we restrict the number of topological types of $(B_{\mathbf{R}}, C'_{\mathbf{R}})$ and $(B_{\mathbf{R}} \cup C'_{\mathbf{C}}, C'_{\mathbf{R}})$.

In Section 2 we present some methods of constructing sublattices of $H_2(Y)$. Such sublattices are used in Section 3 to prohibit all the remaining topological types of $(B_{\mathbf{R}}, C'_{\mathbf{R}})$ except two. These prohibitions are based on calculations of the inertia indices and discriminant for full and overfull sublattices of $\text{Ker}\{(1 + \text{Conj}_*) : H_2(Y) \rightarrow H_2(Y)\}$, cf. [12, 27].

The two exceptional topological types of $(B_{\mathbf{R}}, C'_{\mathbf{R}})$ are prohibited in Section 4 by using the methods of [14]; i.e. by applying the Murasugi-Tristram inequality to the links associated with C' and some, attached to C' , special real pencil of lines.

All the statements containing concrete prohibitions on smoothings of Sirler cusp singularities are called Lemmas; the others are called Propositions.

Note that the proof of Theorem 1 contains many case-by-case prohibitions based

on various tools, and often the same result can be obtained by different methods simultaneously, and we used this occasion to demonstrate better the variety of tools available (specially, when it allows to diminish the complexity of the proof).

Acknowledgments. Our special gratitude is to J.-J. Risler for numerous useful discussions of related problems, and to Y. Amilin and I. Itenberg for pointing out some mistakes in calculation.

§1. LOCAL ANALOGUES OF BASIC FACTS IN THE GEOMETRY OF REAL PLANE ALGEBRAIC CURVES

1.1 Improved local Harnack bound. This bound takes into account the relative position of the non-closed arcs and the complex boundary of a smoothing:

Proposition 1. (see [10] and [11]) *If C is a real isolated plane curve singularity with at least one real branch, the number of ovals of any smoothing C' of C is bounded by $g - a$, where $a + 1$ is the number of topological circles obtained from the union of non-closed arcs of $C'_\mathbf{R}$ by identification of boundary points coming from a common real branch of C (in other words, $a + 1$ is the number of connected components of $(C'_\mathbf{R} \cup \partial C'_\mathbf{C})/\text{Conj}$ minus the number of ovals), $g = \frac{1}{2}(\mu - r + 1)$, μ is the Milnor number and r the number of all, real and imaginary, branches of C .*

Proof. Glue a disc on each hole of $C'_\mathbf{C}$ and apply the global Harnack bound. \square

Corollary 1. *The non-closed arcs of any M -smoothing of a Sirler cusp singularity are arranged as in Figure 2. \square*

Note that the above improved local Harnack bound can be sharp when the usual one is not. For example, a local version of Harnack's construction of M -curves applied to a Sirler cusp singularity gives a smoothing with $v = 11$ and $a = 2$; the non-closed arc arrangement for this smoothing is shown in Figure 3 (certainly, Theorem 1 implies that a smoothing with the non-closed arcs arrangement shown in Figure 2 never turns the improved bound into an equality). It would be interesting to know whether the improved local Harnack bound is sharp for any singularity (see [10] for some related information).

1.2 Elementary consequences of Be zout's theorem. With an isolated plane curve singularity C one can associate two numeric characteristics: $N_1(C)$ and

$N_2(C)$, which are, respectively, the maximum and minimum of the intersection numbers of C' with the straight lines going through the singularity (the maximum is achieved on one of the tangents). For the Sirler cusp singularities, $N_1 = 7$ and $N_2 = 6$. These characteristics have the following evident property:

Proposition 2. *Let C be an isolated plane curve singularity. Then, for any sufficiently small Milnor ball B , and any smoothing C' sufficiently close to C ,*

- (1) *C' meets any straight line at most in $N_1(C)$ points, counting multiplicities;*
- (2) *there exists a ball $B_0 \subset B$, centered at the singular point, such that smoothings close to C meet any straight line crossing $(B_0)_\mathbb{C}$ at least in $N_2(C)$ points, counting multiplicities.*

Let C be a Sirler cusp singularity and the non-closed arcs of its smoothing C' be arranged as in Figure 2 (recall that due to Corollary 1 any M -smoothing must be of this kind). Denote the four connected components of $B_\mathbb{R} \setminus C'_\mathbb{R}$ by $\mathcal{A}, \mathcal{B}_1, \mathcal{B}_2, \mathcal{B}_3$, and the number of ovals in them by a, b_1, b_2, b_3 , respectively (see Figure 2).

Corollary 2. *An M -smoothing of a Sirler cusp singularity has at most one non-empty oval, and if it does exist then it lies in \mathcal{A} .*

Proof. If there are two non-empty ovals or a non-empty oval in \mathcal{B}_i , trace a real straight line through two interior ovals, in the first case, and through the interior oval and a boundary point of $\mathcal{B}_j, j \neq i$, otherwise (see Figure 4). Such a line intersects $C'_\mathbb{R}$ at ≥ 8 points, counting the multiplicities; due to Proposition 2 it is impossible. \square

Further on we encode the arrangement of the ovals of C' by $(a; b_1, b_2, b_3)$, if all the ovals are empty, and by $(1\langle a_1 \rangle \sqcup a_2; b_1, b_2, b_3)$, if there is a non-empty oval embracing a_1 ovals.

In the sequel we use intersections with real conics as well.

Lemma 1. *Let C be a Sirler cusp singularity, $\{C'_t\}_{0 \leq t \leq t^*}$ its smoothing and $\{K_t\}_{0 \leq t \leq t^*}$ a continuous 1-parameter family of real conics. Assume that for each t the intersection of K_t with C'_t consists of at least 8 points counting multiplicities. Then there exists a Milnor ball B such that, up to taking smaller t^* :*

- (1) *Each K_t meets C'_t in at most 14 points counting multiplicities.*

- (2) *Either each $(K_t)_{\mathbf{R}}$, $t \neq 0$, is an ellipse, contained in $B_{\mathbf{R}}$, or each $(K_t)_{\mathbf{R}}$, $t \neq 0$, has two connected components in $B_{\mathbf{R}}$. In the latter case, K_t converges to the union of two real straight lines (may be, coinciding), as $t \rightarrow 0$. These straight lines L_1, L_2 pass through the singular point 0 of C , and K_t intersects $\partial B_{\mathbf{R}}$ at four points close to the intersection points of L_1, L_2 with $\partial B_{\mathbf{R}}$.*

Proof. The statements follow from the fact that the intersection multiplicity of a conic with C at 0 is bounded by 7 if the conic is non-singular at 0 and by 13 if the conic is not a pair of straight lines tangent to C at 0 . \square

The following classical statement is of major importance in further applications.

The Cayley lemma. *If $D \in \mathbf{R}^2$ lies inside the triangle generated by $A, B, C \in \mathbf{R}^2$, each real conic passing through A, B, C , and D crosses any compact real conic embracing A, B, C , and D at four real points. If five points in \mathbf{R}^2 are the vertices of a convex polygon, then they lie on the same connected real component of the conic passing through them.*

1.3 Complex orientations. Let us introduce some invariants of the boundary of an oriented real isolated plane curve singularity involved in the local versions of Rokhlin's complex orientations formula. Consider in $S^3 = \partial B_{\mathbf{C}}$ a 1-dimensional smooth submanifold Z which is invariant under the complex conjugation and nowhere tangent to $\partial B_{\mathbf{R}}$. Suppose that Z is oriented and decomposed into two halves, Z^+ and Z^- , with $\partial Z^+ = \partial Z^- = Z \cap \partial B_{\mathbf{R}}$. Given an orientation ω of $B_{\mathbf{R}}$ and $\xi \in H_1(\partial B_{\mathbf{R}}, Z \cap \partial B_{\mathbf{R}}; \mathbf{Z})$ such that $\partial \xi = -\partial[Z^-] = \partial[Z^+]$ (Z^{\pm} inherit the orientation from Z), there are well defined linking numbers $\text{link}([Z^-] + \xi, [Z^+] - \xi)$ and $\text{link}([Z^-] + \xi, \partial[B_{\mathbf{R}}])$.

To make sense of these linking numbers (depending on ω) we push $Z^+ \cup \partial B_{\mathbf{R}}$ along a special vector field $V\sqrt{-1}$. Namely, on $\partial B_{\mathbf{R}}$ oriented as the boundary of $B_{\mathbf{R}}$ we take V tangent to $\partial B_{\mathbf{R}}$, directing its orientation, and then extend V in an arbitrary way to Z^+ . Clearly, the linking numbers obtained do not depend on the choice of the extension and are invariant under auto-homeomorphisms of $\partial B_{\mathbf{C}}$ commuting with complex conjugation and preserving orientation of $\partial B_{\mathbf{R}}$.

Indeterminacy in the choice of ξ is avoided, if we pick up a point $p \in \partial B_{\mathbf{R}} \setminus Z$ and take ξ in $H_1(\partial B_{\mathbf{R}} \setminus \{p\}, Z \cap \partial B_{\mathbf{R}}; \mathbf{Z})$.

Let C be a real isolated plane curve singularity, B its Milnor ball and $Z = C \cap \partial B_{\mathbf{C}}$. Orient Z as the boundary of C , fix an orientation ω of $B_{\mathbf{R}}$ and pick a point $p \in \partial B_{\mathbf{R}} \setminus C_{\mathbf{R}}$. Suppose, for simplicity, that C has no imaginary branches. Then $C_{\mathbf{R}}$ divides each branch in two halves. The choice of orientation of real branches of $C_{\mathbf{R}}$ is equivalent to the selection of an imaginary half on each branch: the complex orientation of an imaginary half determines the boundary orientation of the real branch. Thus, one speaks of a *complex orientation of $C_{\mathbf{R}}$* and the associated half C^+ , for which $\partial[C^+] = [C_{\mathbf{R}}]$; the conjugated half is denoted by C^- . We put $Z^{\pm} = C^{\pm} \cap \partial B_{\mathbf{C}}$ and

$$M_1 = \text{link}([Z^-] + \xi, [Z^+] - \xi), \quad M_2 = \text{link}([Z^-] + \xi, [\partial B_{\mathbf{R}}]).$$

Consider a smoothing C' of C included in a smoothing out deformation $\{C_t\}$ which does not cross p . A smoothing C' is called of type I if $C'_{\mathbf{C}} \setminus C'_{\mathbf{R}}$ is not connected. In this case $C'_{\mathbf{C}} \setminus C'_{\mathbf{R}}$ has two connected components, C'^+ and C'^- , the curve $C'_{\mathbf{R}}$ is the common part of the boundary of C'^+ and C'^- , and the complex orientation of C'^+ and C'^- defines on $C'_{\mathbf{R}}$ the two opposite orientations, called *complex orientations of $C'_{\mathbf{R}}$* .

Let us pick a complex orientation of $C'_{\mathbf{R}}$. Given a non-closed arc l of $C'_{\mathbf{R}}$, there is one and only one connected component $D_{l,p}$ of $B_{\mathbf{R}} \setminus l$ not containing p . Orient $D_{l,p}$ in a way that its boundary orientation is the complex orientation of $l \subset C'_{\mathbf{R}}$ and pose $\varepsilon(D_{l,p}) = 1$, if the orientation of $D_{l,p}$ coincides with ω and -1 , if it does not.

Two ovals of $C'_{\mathbf{R}}$, bounding an annulus in $B_{\mathbf{R}}$, form a *positive injective pair* if their complex orientation coincides with a boundary orientation of the annulus, otherwise the injective pair is called *negative*. Each oval bounds a disc D in $B_{\mathbf{R}}$ and the oval is called *positive* (with respect to ω) if its complex orientation coincides with the boundary orientation defined by $\omega|_D$, conversely, it is called *negative*. Denote by v the number of ovals; by Π^- and Π^+ , the number of negative and positive injective pairs of ovals, respectively; by v^- and v^+ , the number of negative and positive ovals, respectively; by $v^-(l)$ and $v^+(l)$, the number of negative and positive ovals contained in $D_{l,p}$, respectively.

If C' is a type I smoothing of C , the smoothing out deformation transports the complex orientations of $C'_{\mathbf{R}}$ and gives in the limit the complex orientations of $C_{\mathbf{R}}$;

we call them *coherent complex orientations* of $C_{\mathbf{R}}$ and $C'_{\mathbf{R}}$.

Proposition 4. (cf. [21]) *In the previous notation for any type I smoothing C' of C and coherent complex orientations of $C_{\mathbf{R}}$ and $C'_{\mathbf{R}}$,*

$$(1.1) \quad v + 2(\Pi^- - \Pi^+) + \sum_l (r(D_{l,p}) + 2(v^+(l) - v^-(l))\varepsilon(D_{l,p})) \\ + \sum_{D_{l,p} \subseteq D_{m,p}} \varepsilon(D_{l,p})\varepsilon(D_{m,p})r(D_{l,p}) = M_1 ,$$

$$(1.2) \quad v^- - v^+ - \sum_l \varepsilon(D_{l,p})r(D_{l,p}) = M_2 ,$$

where l, m run over all non-closed arcs of $C'_{\mathbf{R}}$ and $r(D_{l,p}) = \frac{1}{2}(1 - \varepsilon(D_{l,p}))$.

Proof. Follow Rokhlin's proof of his global complex orientations formula, see [18]. Glue into C'^- the discs $D_{l,p}$ and the discs bounded in $B_{\mathbf{R}}$ by the ovals of $C'_{\mathbf{R}}$. This gives an integral relative 2-cycle Σ^- in $(B_{\mathbf{C}}, \partial B_{\mathbf{C}})$. Its boundary is $[Z^-] + \xi$, where $Z^- = C'^- \cap \partial B_{\mathbf{C}}$, $\xi \in H_1(\partial B_{\mathbf{R}} \setminus \{p\}, Z \cap \partial B_{\mathbf{R}}; \mathbf{Z})$, and Z^- inherits the orientation from $\partial C'^-$. By definition, $M_1 = \text{link}([Z^-] + \xi, [Z^+] - \xi)$ and $M_2 = \text{link}([Z^-] + \xi, [\partial B_{\mathbf{R}}])$, where $Z^+ = C'^+ \cap \partial B_{\mathbf{C}}$. Take on $\partial B_{\mathbf{R}}$ the field V which directs the orientation of $\partial B_{\mathbf{R}}$. We extend it, first, to $B_{\mathbf{R}}$ to obtain a field tangent to $B_{\mathbf{R}}$ and such that nowhere on $C'_{\mathbf{R}}$ it is tangent to $C'_{\mathbf{R}}$ with the direction of the complex orientation of $C'_{\mathbf{R}}$ (the opposite direction is allowed). Then extend V arbitrarily to $\Sigma^- \setminus B_{\mathbf{R}}$ and shift Σ^- along $V\sqrt{-1}$. The identities (1.1) and (1.2) follow now from counting the intersection number of the shifted cycle with, respectively, $-\text{Conj}(\Sigma^-)$ (which is, indeed, Σ^+) and $B_{\mathbf{R}}$. \square

Proposition 5. *If a real isolated plane curve singularity C has only real branches then for any complex orientation of C there exists a smoothing \hat{C} of type I whose complex orientation is coherent to the complex orientation of C .*

Proof. As in [16, 10] we use a recursion by the number of blowing-ups making the strict transform of C nonsingular.

At each step contracting back an exceptional divisor E we deform the strict transform (and, thus, C) and keep the complex orientation as follows: (1) if E which we are going to contract meets the strict transform C^* (C is the current deformation) at a non-singular branch with multiplicity > 1 , then we deform this

branch so that it intersects E at distinct and only real points; (2) if C^* has an ordinary singularity, a transverse intersection of several real branches, then we move these branches to a general position and smooth out all nodes according to the complex orientation of intersecting branches. \square

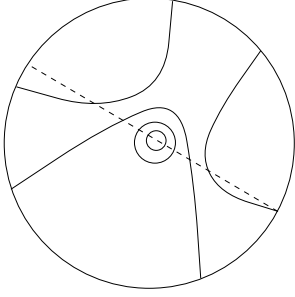

FIGURE 4

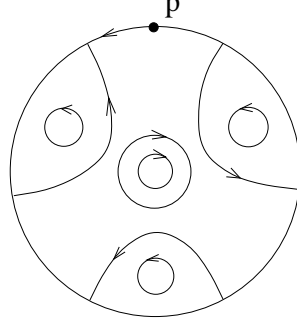

FIGURE 5

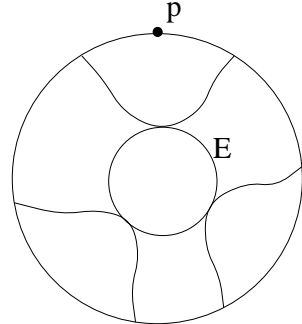

FIGURE 6

To apply Proposition 4 to the Sirler cusp singularities we fix the usual counter-clockwise orientation of $B_{\mathbf{R}}$ and, in accordance with Proposition 4 and respective notion, call an oval positive, if it is also oriented counter-clockwise, and negative otherwise.

Lemma 2. *For any M -smoothing of a Sirler cusp singularity the non-closed arcs are arranged as in Figure 2 and have a complex orientation as shown there. The respective complex orientation of the ovals satisfies the following relations:*

$$(1.3) \quad a^+ - a^- = 1, \quad \sum_j (b_j^+ - b_j^-) = 0$$

if the smoothing is of type $(a; b_1, b_2, b_3)$;

$$(1.4) \quad a_2^+ - a_2^- = 0, \quad a_1^+ - a_1^- + \sum_j (b_j^+ - b_j^-) = 0$$

if the smoothing is of type $(1\langle a_1 \rangle \sqcup a_2; b_1, b_2, b_3)$ with positive non-empty oval; and

$$(1.5) \quad 2(a_1^+ - a_1^-) + a_2^+ - a_2^- = 2, \quad a_1^- - a_1^+ + \sum_j (b_j^+ - b_j^-) = 0$$

if the smoothing is of type $(1\langle a_1 \rangle \sqcup a_2; b_1, b_2, b_3)$ with negative non-empty oval. Here, by $+$ and $-$ we specify the number of positive and negative ovals in the respective domains.

Proof. The first statement follows from Proposition 1. To get the relations (1.3)-(1.5) we apply Proposition 4. The values of M_1 and M_2 are calculated using the

type I smoothing shown in Figure 5; this smoothing is obtained by construction from Proposition 5. Finally, (1.1) and (1.2) give $\Pi^- - \Pi^+ + \sum(v^+(l) - v^-(l)) = 0$ and $v^+ - v^- = 1$, and the result follows. \square

1.4 Congruence modulo 8.

Lemma 3. *An M -smoothing of a Sirler cusp singularity satisfies the congruence*

$$b_1 + b_2 + b_3 - a \equiv 3 \pmod{8}$$

if the smoothing is of type $(a; b_1, b_2, b_3)$, and the congruence

$$a_1 + b_1 + b_2 + b_3 - a_2 \equiv 4 \pmod{8}$$

if it is of type $(1\langle a_1 \rangle \sqcup a_2; b_1, b_2, b_3)$.

This is a particular case of the local Gudkov-Arnold-Rokhlin congruences given in [11]. There exist two approaches leading to such congruences. One of them puts into action the double coverings. Since we use further the same coverings to obtain additional prohibitions, we introduce them here and fabricate from them a closed manifold which is the main object of the next section. The construction below is quite general. For brevity, we apply it directly to a Sirler cusp singularity.

Let C be a Sirler cusp singularity and C' its smoothing. Consider a Milnor ball B , blow up its center, and denote by \hat{B} the blown-up ball and by \hat{C} the strict transform of C (see Figure 6, where the annulus represents $\hat{B}_{\mathbf{R}}$ cut along $E_{\mathbf{R}}$ and the internal circle represents the double covering of $E_{\mathbf{R}}$). The pairs $(B_{\mathbf{C}}, C_{\mathbf{C}})$ and $(\hat{B}_{\mathbf{C}}, \hat{C}_{\mathbf{C}})$ have the same boundary and there is a diffeotopy $\{\varphi_t\}_{t \geq 0}$ of the identity map $\partial B_{\mathbf{C}} \rightarrow \partial B_{\mathbf{C}}$ which transforms $\partial(C'_t)_{\mathbf{C}}$ into $\partial C_{\mathbf{C}} = \partial \hat{C}_{\mathbf{C}}$. Glue $B_{\mathbf{C}}$ and $\hat{B}_{\mathbf{C}}$ along the boundary by φ_t , $t > 0$. The resulting space, which we denote by X , is a smooth orientable 4-manifold and $S = C'_{\mathbf{C}} \cup \hat{C}_{\mathbf{C}}$, where $C' = C'_t$ can be viewed as its smooth orientable 2-submanifold. We equip X (and S) with the orientation which is the usual, complex orientation on $B_{\mathbf{C}} \subset X$ (and on $C'_{\mathbf{C}} \subset S$). Note that the genus of S is 13; indeed, the singularity genus of C , i.e., the genus of $S \cap B_{\mathbf{C}}$, is 13 and $\hat{C}_{\mathbf{C}}$ is the union of three discs.

There is a diffeomorphism between X and $\mathbf{C}P^2$ which transforms the orientation of X into the usual orientation of $\mathbf{C}P^2$, and the exceptional curve $E \subset \hat{B}$ into a straight line. We keep on E its original complex orientation. Then $[S] \circ [E] = 6$

and, thus $[S] = 6[E] \in H_2(X) = \mathbf{Z}$. Since $[S]$ is divisible by 2, there exists a double covering $\pi : Y \rightarrow X$ branched along S . It is unique and splits into two coverings $\pi^+ : Y^+ \rightarrow B_{\mathbf{C}}$ and $\pi^- : Y^- \rightarrow \hat{B}_{\mathbf{C}}$.

Proposition 6. *Y is a simply connected Spin-manifold with $\beta_2 = 28$, $\chi = 30$, and $\text{sign} = -16$, where β_2, χ , and sign stand for second Betti number, Euler characteristic and signature, respectively.*

Proof. To check that $\pi_1 = 1$ apply Van-Kampen's theorem to $Y = Y^+ \cup Y^-$. Since Y^+ is a Milnor fiber of a space surface singularity $z^2 = f(x, y)$, it is simply connected, and it remains to observe that $\pi_1(Y^+ \cap Y^-) \rightarrow \pi_1(Y^-)$ is surjective. The Wu class of Y and the other invariants are calculated by the usual projection formulas for double coverings: $w_2(Y) = \pi^*(w_2(X)) + [S] = \pi^*[E] + [S] = 0 \in H_2(X; \mathbf{Z}/2)$, $\chi(Y) = 2\chi(X) - \chi(S) = 6 + 24$, and $\text{sign}(Y) = 2 \text{sign}(X) - S \circ_Y S = 2 - 18(E \circ_X E) = -16$. \square

The germ C and its smoothing C' are real. Thus, the complex conjugation $\text{Conj} : B_{\mathbf{C}} \rightarrow B_{\mathbf{C}}$ induces an involution $\text{Conj} : X \rightarrow X$ and lifts into two commuting involutions $\text{Conj}_1, \text{Conj}_2 : Y \rightarrow Y$. Denote their fixed points sets by $X_{\mathbf{R}}, Y_{\mathbf{R}}^1$, and $Y_{\mathbf{R}}^2$. It is clear that $X_{\mathbf{R}} = \pi(Y_{\mathbf{R}}^1) \cup \pi(Y_{\mathbf{R}}^2)$ and $\pi(Y_{\mathbf{R}}^1), \pi(Y_{\mathbf{R}}^2)$ are surfaces with common boundary $\hat{C}_{\mathbf{R}} \cup C'_{\mathbf{R}}$. All the involutions preserve orientation of their respective 4-manifolds. Note that these real structures, Conj_1 and Conj_2 , considered up to equivariant diffeomorphisms depend on the smoothing C' chosen. However, for a chosen smoothing they do not depend on $t > 0$.

Let us set

$$Y_{\mathbf{R}}^{k+} = Y_{\mathbf{R}}^k \cap Y^+, \quad Y_{\mathbf{R}}^{k-} = Y_{\mathbf{R}}^k \cap Y^-, \quad X_{\mathbf{R}}^+ = X_{\mathbf{R}} \cap B_{\mathbf{C}}, \quad X_{\mathbf{R}}^- = X_{\mathbf{R}} \cap \hat{B}_{\mathbf{C}},$$

and choose the numeration of $\text{Conj}_1, \text{Conj}_2$ in a way that $\pi(Y_{\mathbf{R}}^{1+})$ contains the point p (see Figure 2), and $\pi(Y_{\mathbf{R}}^{2+})$ does not.

Proposition 7. *If C' is an M -smoothing with non-closed arcs arranged as shown in Figure 2, the involution $\text{Conj}_2 : Y \rightarrow Y$ is Smith-maximal, i.e., $\beta_*(Y_{\mathbf{R}}^2) = \beta_*(Y)$.*

Proof. The half $Y_{\mathbf{R}}^{2+}$ is the trivial double of the half of $B_{\mathbf{R}}$ bounded by $C'_{\mathbf{R}}$ and not containing p . The half $Y_{\mathbf{R}}^{2-}$ covers (non trivially) twice the half of $\hat{B}_{\mathbf{R}}$ bounded by $\hat{C}_{\mathbf{R}}$ and containing $E_{\mathbf{R}}$. It remains to count the number of components of $Y_{\mathbf{R}}^2$ and calculate $\chi(E_{\mathbf{R}})$. \square

Proposition 8. *For any $k = 1, 2$ and any component F of $Y_{\mathbf{R}}^k$,*

$$F \circ F = \chi(F \cap Y^-) - \chi(F \cap Y^+).$$

Proof. The smooth surfaces $Y_{\mathbf{R}}^{k\pm}$ are totally real in Y^\pm , as soon as Y^\pm are equipped with their natural complex structure. Our orientation of Y is the complex one on Y^+ and the opposite one on Y^- . \square

Remark. As it follows, f.e., from Proposition 8, there is no almost complex structure on the whole Y (and, similarly, on the whole X) for which $Y_{\mathbf{R}}$ (and $X_{\mathbf{R}}$) is totally real. It is why, in particular, we should adjust properly many of traditional calculations, though, in many respects, S looks as a “flexible” real curve of degree 6 in P^2 .

Proof of Lemma 3. Due to Proposition 7, the Gudkov-Arnold-Rokhlin congruence (see [17]) applies. According to this congruence, $Y_{\mathbf{R}}^2 \circ Y_{\mathbf{R}}^2 \equiv \text{sign}(Y) \pmod{16}$. In our case, due to Proposition 8, $Y_{\mathbf{R}}^2 \circ Y_{\mathbf{R}}^2 = \chi(Y_{\mathbf{R}}^{2-}) - \chi(Y_{\mathbf{R}}^{2+})$. This gives $Y_{\mathbf{R}}^2 \circ Y_{\mathbf{R}}^2 = 2(b_1 + b_2 + b_3 - a - 3)$ for type $(a; b_1, b_2, b_3)$ and $Y_{\mathbf{R}}^2 \circ Y_{\mathbf{R}}^2 = 2(a_1 + b_1 + b_2 + b_3 - a_2 - 4)$ for $(1\langle a_1 \rangle \sqcup a_2; b_1, b_2, b_3)$. \square

1.5 Arnold inequalities.

Lemma 4. *A Sirler cusp singularity has no M -smoothing of type $(1\langle a_1 \rangle \sqcup a_2; b_1, b_2, b_3)$ with $b_1 + b_2 + b_3 > 2$.*

In fact, this is a particular case of a local version of Arnold inequalities (cf. [2]). To prove it we need to know some numerical characteristics of the eigenlattices $H'_\varepsilon = \{x \in H_2(Y) | \text{Conj}_1 x = \varepsilon x\}$, $H''_\varepsilon = \{x \in H_2(Y) | \text{Conj}_2 x = \varepsilon x\}$, and $H^{\varepsilon_1, \varepsilon_2} = H'_{\varepsilon_1} \cap H''_{\varepsilon_2}$. Note, right away, that the lattices $H^{\varepsilon_1, \varepsilon_2}$ are pairwise orthogonal, since the involutions Conj_1 and Conj_2 , as any diffeomorphisms preserving orientation, preserve the intersection form in Y .

In what follows the inertia indices of a lattice (i.e., the numbers of positive and negative entries in diagonalizations over \mathbf{R}) are denoted by ind_+ , ind_- .

Proposition 9. *For any M -smoothing of a Sirler cusp singularity the inertia indices and discriminants of the lattices $H'_\varepsilon, H''_\varepsilon$, and $H^{\varepsilon_1, \varepsilon_2}$, are the following:*

$$H^{-,+} = H''_+, \quad \text{ind}_+(H''_+) = 1, \quad \text{ind}_-(H''_+) = 13 - \chi_0, \quad \text{discr } H''_+ = -1,$$

where χ_0 is the Euler characteristic of the half $\pi(Y_{\mathbf{R}}^{j+})$ of $B_{\mathbf{R}}$ ($j = 1, 2$) which contains p ;

$$H^{-,-} = \mathbf{Z}e, \quad e^2 = 2,$$

where $e \in H''_-$ is realized by the pull-back of the exceptional curve $E \subset \hat{B}_{\mathbf{C}}$;

$$H^{+,-} = H''_- \cap e^\perp = H'_+, \quad \text{ind}_+(H'_+) = 4, \quad \text{ind}_-(H'_+) = 9 + \chi_0, \quad \text{discr } H'_+ = -2;$$

the other bi-eigenspaces are zero.

Note that $\chi_0 = a_1 - a_2 + b_1 + b_2 + b_3$ for smoothings of type $(1 < a_1 > \sqcup a_2; b_1, b_2, b_3)$ and $\chi_0 = 1 - a + b_1 + b_2 + b_3$ for those of type $(a; b_1, b_2, b_3)$.

Proof. Due to Corollary 1 the non-closed arcs of an M -smoothing should be arranged as in Figure 2. So, according to Proposition 7, Conj_2 is a Smith-maximal involution, and, hence, $H_2(Y) = H''_+ + H''_-$. In particular, the lattices H''_+ and H''_- are unimodular. To get their signatures it remains to apply the Lefschetz and Hirzebruch formulas to Conj_2 . All the other statements follow from the fact that $\text{Conj}_1 \circ \text{Conj}_2$ is the deck transformation of the covering $Y \rightarrow X$ and the deck transformation of this covering induces in $H_2(Y)$ a reflection with respect to e , which is the generator of the pull-back of $H_2(X)$. \square

Corollary 3. *For any M -smoothing of a Sirler cusp singularity one has $-9 \leq \chi_0 \leq 13$.*

Proof. The inertia indices of H''_+ and H''_- are nonnegative. \square

Proposition 10. *All the components of $Y_{\mathbf{R}}^1$ and $Y_{\mathbf{R}}^2$ are orientable. The components of $Y_{\mathbf{R}}^1$ realize elements in H'_+ and that of $Y_{\mathbf{R}}^2$ elements in H''_+ .*

Proof. The characteristic class of the double coverings $Y_{\mathbf{R}}^1 \rightarrow \pi(Y_{\mathbf{R}}^1)$ and $Y_{\mathbf{R}}^2 \rightarrow \pi(Y_{\mathbf{R}}^2)$ is induced by $w_1(X) = [E_{\mathbf{R}}]$. \square

Note that an orientation of $Y_{\mathbf{R}}^1$ and $Y_{\mathbf{R}}^2$ can be chosen in the following way. Pick an orientation ω of $B_{\mathbf{R}}$. Represent Y^+ by $z^2 = f(x, y)$ where $f > 0$ in $Y_{\mathbf{R}}^{1+}$. Lift ω to the leafs of $Y_{\mathbf{R}}^{1+}$ with $\text{Re}z > 0$ and to the leafs of $Y_{\mathbf{R}}^{2+}$ with $\Im z > 0$. This orientation extends to an orientation of the whole $Y_{\mathbf{R}}^1$ and $Y_{\mathbf{R}}^2$. We call this orientation the *upper leaf orientation induced by ω* .

Proof of Lemma 4. Assume that such a smoothing exists. Consider two elements in H_+'' : one, $[y_1]$, is realized by the component y_1 of $Y_{\mathbf{R}}^2$ covering the region of $X_{\mathbf{R}}$ containing $E_{\mathbf{R}}$, the second, y_2 , by the component y_2 covering the region between the nonempty oval and the ovals embraced by it. They are orthogonal and have nonnegative squares: due to Proposition 8, $[y_1]^2 = 2(\sum b_j - 3)$ and $[y_2]^2 = 2a_1 - 2$. Then, from Proposition 9, it follows that $[y_1]$ and $[y_2]$ are dependent over \mathbf{Q} . On the other hand, it follows from the exact Smith sequence applied to the deck transformation of $Y \rightarrow X$ that the images of $[y_1]$ and $[y_2]$ in $H_2(Y; \mathbf{Z}/2)$ are independent over $\mathbf{Z}/2$ (the latter follows from the exactness of the Smith sequence and the fact that the boundary of the regions of $X_{\mathbf{R}}$ defining $[y_1]$ and $[y_2]$ does not divide S). \square

Summary. Due to Corollary 1, Lemma 3, Corollary 3, and Lemma 4, an M -smoothing of a Sirlar cusp singularity has the non-closed arc arrangement shown in Figure 2 and the distribution of its ovals between the regions $\mathcal{A}, \mathcal{B}_1, \mathcal{B}_2$, and \mathcal{B}_3 , is one of the following:

$$(2.1a) \quad (1; b_1, b_2, b_3), \quad 0 \leq b_1 \leq b_2 \leq b_3, \quad b_1 + b_2 + b_3 = 12,$$

$$(2.1b) \quad (5; b_1, b_2, b_3), \quad 0 \leq b_1 \leq b_2 \leq b_3, \quad b_1 + b_2 + b_3 = 8,$$

$$(2.1c) \quad (9; b_1, b_2, b_3), \quad 0 \leq b_1 \leq b_2 \leq b_3, \quad b_1 + b_2 + b_3 = 4,$$

$$(2.1d) \quad (1\langle a_1 \rangle; b_1, b_2, b_3), \quad 0 \leq b_1 \leq b_2 \leq b_3, \quad a_1 + b_1 + b_2 + b_3 = 12, \quad a_1 \geq 10,$$

$$(2.1e) \quad (1\langle a_1 \rangle \sqcup 4; b_1, b_2, b_3), \quad 0 \leq b_1 \leq b_2 \leq b_3, \quad a_1 + b_1 + b_2 + b_3 = 8, \quad a_1 \geq 6,$$

$$(2.1f) \quad (1\langle a_1 \rangle \sqcup 8; b_1, b_2, b_3), \quad 0 \leq b_1 \leq b_2 \leq b_3, \quad a_1 + b_1 + b_2 + b_3 = 4, \quad a_1 \geq 2.$$

§2. CONSTRUCTION OF SUBLATTICES IN $H_2(Y)$

In this section we construct several series of auxiliary 2-cycles in Y and calculate their matrices of intersection numbers. They are used in Section 3 to prohibit most of the remaining schemes of M -smoothings (see Summary in Section 1).

2.1 Purely real cycles. Recall that, due to our notation, $Y_{\mathbf{R}}^1 = \text{FixConj}_1$, $Y_{\mathbf{R}}^2 = \text{FixConj}_2$, $\pi(Y_{\mathbf{R}}^1)$ contains the point p , and $\pi(Y_{\mathbf{R}}^2)$ does not. According to Proposition 10 all the components y_i^1 and y_j^2 of $Y_{\mathbf{R}}^1$ and, respectively, $Y_{\mathbf{R}}^2$ are orientable. Let us denote by $[y_i^1]$ and $[y_j^2]$ their fundamental cycles corresponding to some (not fixed) orientation.

Let us number the components in such a way that: $\pi(y_1^1)$ contains p ; $\pi(y_2^1), \dots, \pi(y_s^1)$ ($s \geq 2$) are the discs bounded by the empty ovals in $\mathcal{B}_1, \mathcal{B}_2, \mathcal{B}_3$ and empty ovals inside the non-empty oval (if it exists); $\pi(y_1^2)$ contains the exceptional curve $E_{\mathbf{R}} \subset X_{\mathbf{R}}^-$. If the non-empty oval exists, assume that the component whose projection is bounded by it is y_2^2 .

Note that, according to Summary in Section 1, $s = 5$, or 9, or 13 and the number of components of $Y_{\mathbf{R}}^2$ is $14 - s$.

Proposition 11.

- (1) $[y_1^1]^2 = 6$, or 14, or 22 according to whether C' is of type (2.1a), (2.1d), or (2.1b), (2.1e), or (2.1c), (2.1f);
- (2) $[y_1^2]^2 = 2(b_1 + b_2 + b_3 - 3)$; $[y_i^1]^2 = [y_j^2]^2 = -2$ for $s \geq i \geq 2, j \geq 3$;
- (3) $[y_2^2]^2 = -2$, or $2a_1 - 2$ according to if $\pi(y_2^2)$ is bounded by an empty or non-empty oval;
- (4) $[y_i^k] \circ [y_j^l] = 0$ for $(k, i) \neq (l, j)$.

Proof. The relations (1) - (3) follow from Proposition 8. The remaining one, (4), is trivial. \square

2.2 Almost real cycles. Pick a point $O \in B_{\mathbf{R}} \setminus C'$ and two real straight lines $l_0 = 0$ and $l_1 = 0$ passing through this point. Denote by L the part of $B_{\mathbf{R}}$ covered by the lines $l_t = 0$, where $l_t = tl_0 + (1 - t)l_1$ and $0 \leq t \leq 1$.

Let us fix $k = 1$ or 2 and suppose that:

- (i) the number m of intersection points of the line l_t with $C'_{\mathbf{C}}$ is constant for $0 \leq t \leq 1$, except for a finite number of values of t ;
- (ii) each of l_0 and l_1 intersects C' transversally in $m - 2$ real points and with simple tangency in one real point, where the curve $C'_{\mathbf{R}}$ comes up from the outside of L (and thus a line from the other half of the pencil, $l_t = tl_0 - (1 - t)l_1$, intersects C' in m real points, if this line is close to l_0 or l_1);

- (iii) the germs of l_0 and l_1 at the points of tangency are contained both in the same component of $\pi(Y_{\mathbf{R}}^k)$;
- (iv) for each $0 \leq t \leq 1$ the line l_t intersects $C'_{\mathbf{R}}$ in at least $m - 2$ points.

Under these conditions a natural Conj_k -invariant surface with boundary lying inside $\bigcup_t (l_t)_{\mathbf{C}}$ appears. The details of the construction (introduced by Viro [26]) can be found in [12]. Here we summarize the results needed for prohibitions.

To construct the desired surface we pick up an one-dimensional submanifold Λ of $\pi(Y_{\mathbf{R}}^k) \cap L$ such that: $\partial\Lambda$ is the set of the points of tangency of the half pencil $l_t, 0 \leq t \leq 1$, with $C'_{\mathbf{R}}$; each l_t which is not tangent to $C'_{\mathbf{R}}$ intersects Λ in $2 - j$ points, where $2j = 0$ or 2 is the number of imaginary points in the intersection of l_t with $C'_{\mathbf{C}}$.

Then there exists a compact orientable surface $M \subset B_{\mathbf{C}}$ such that

- (1) M is contained in $\bigcup_t (l_t)_{\mathbf{C}}$;
- (2) $\partial M \subset C'_{\mathbf{C}}, M \cap B_{\mathbf{R}} = \Lambda$;
- (3) $M = M^+ \cup M^-$, $M^- = \text{Conj } M^+$, $M^+ \cap M^- = \partial M^+ \cap \partial M^- = \Lambda$, where M^+ and M^- are homeomorphic to a disc;
- (4) the covering $Y \rightarrow B_{\mathbf{C}}$ is trivial over the interior of M .

Denote by Φ the pull-back of M in Y . Due to (2)–(4), Φ is a closed orientable surface. In particular, the homology class ϕ of Φ in $H_2(Y)$ is well defined, up to a sign depending on the choice of orientation of Φ . The self-intersection number $\phi \circ \phi$ does not depend on this choice.

Proposition 12. *For any line sector $L = \bigcup_t l_t$ satisfying the conditions (i) – (iv) above, one has $\phi \in H'_+$, if $k = 2$ and $\phi \in H''_+$ otherwise, and in the both cases*

$$\phi \circ \phi = \sum_{q \in \partial\Lambda} v(q),$$

where the sum is taken over $q \in \partial\Lambda$ and $v(q) = -1$ if in its neighborhood the germ of l_t , which is tangent at q to $C'_{\mathbf{R}}$, is contained in $\pi(Y_{\mathbf{R}}^k)$ and 1 otherwise (see Figure 7, where the dotted lines represent Λ).

This fact follows from Lemmas 5.2, 5.3, 5.4 in [12].

Remark. Note that the surface $\Phi \subset Y$ is smooth and totally real at all points except some of the points of tangency of Λ to $C'_{\mathbf{R}}$. The above formula can be deduced

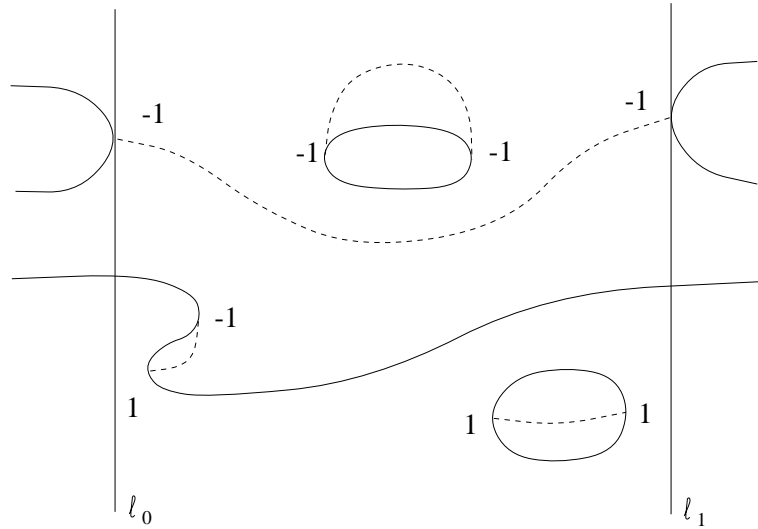

FIGURE 7

from the counting the weights of the complex points of a smoothing of Φ and the adjunction formula $\chi(\Phi) + \Phi \circ \Phi = c$, where c is the total weight of the complex points. The surface in question, Φ , depends on the choice of three objects: the center O , the half pencil $l_t = tl_0 + (1-t)l_1$, and the one-dimensional manifold Λ . They can be changed with conservation of the homology class of the surface. For example, any small shift of O can be accompanied by a continuous variation of l_t and Λ with preserving all conditions imposed on them. If Φ' is the surface constructed in such a way for a point O' , a variation of O , then each orientation of Φ is transported naturally to Φ' and Φ' thus oriented realizes the same homology class ϕ as Φ . The formula for $\phi \circ \phi$ from Proposition 12 was originally obtained by Viro through counting $\Phi \circ \Phi'$.

To calculate the intersection number of ϕ with the real cycles some additional auxiliary numerical characteristics are needed.

Fix an orientation ω of $B_{\mathbf{R}}$. Consider the point q_0 where Λ meets l_0 . Orient $C'_{\mathbf{R}}$ locally at q_0 as the boundary of $\pi(Y_{\mathbf{R}}^{\bar{k}})$, $\bar{k} = 3 - k$, where the latter is oriented by ω . Denote by M^+ that half of M whose cone of tangent rays at q_0 contains $\xi\sqrt{-1}$ where ξ directs the chosen orientation of $C'_{\mathbf{R}}$ at q_0 .

Represent Y^+ by $z^2 = f(x, y)$ with $f > 0$ in $Y_{\mathbf{R}}^{1+}$, and consider the upper half orientation of $Y_{\mathbf{R}}^1$ and $Y_{\mathbf{R}}^2$ induced by ω (see 1.5). Orient in an arbitrary way \tilde{M}^+ , where \tilde{M}^+ is a half of the pull back of M^+ . Extend this orientation to an orientation of the whole Φ .

Denote by $\lambda(q) = \pm 1$ the sign of $\operatorname{Re}z$, if $k = 1$, or $\Im z$, if $k = 2$, on the part of $\tilde{\Lambda} = \pi^{-1}\Lambda \cap \tilde{M}^+$ adjacent to q . In other words, this sign is well defined at each point of the interior of Λ , it is constant on each connected component and we extend it to the boundary points by continuity.

Proposition 13. *Under conditions of Proposition 12, for any connected component y of $Y_{\mathbf{R}}^{3-k}$ equipped with its upper half orientation*

$$[y] \circ \phi = \sum_{q \in \pi(y) \cap \partial\Lambda \cap L_1} \lambda(q)v(q) - \sum_{q \in \pi(y) \cap \partial\Lambda \cap L_2} \lambda(q)v(q);$$

where L_1, L_2 are the two, properly numbered, halves of $L \setminus O$. All the values of $\lambda(q)$ are determined by $\lambda(q_0)$ and the position of Λ with respect to the branches of $C'_{\mathbf{R}}$: when q jumps from a connected component of Λ to the next one on ∂M^+ , the variation of $\lambda(q)$ is equal mod 4 to the number of the components of $C'_{\mathbf{R}} \cap L$ lying in between.

Proof. It follows, for instance, from Lemmas 5.2, 5.3, 5.4 in [12].

Corollary 4. *Let $L = \cup_t l_t$ be a line sector satisfying (i) – (iv) and touched from the outside by two ovals ν_1 and ν_2 lying in \mathcal{B}_s . Suppose that $k = 2$ and the lines l_t with $0 < t < 1$ do not intersect any oval of C' . Then $\phi \in H'_+$ and*

$$\phi^2 = -2, \quad \phi \circ [y_i^1] = \lambda(q_0), \quad \phi \circ [y_j^1] = \lambda(q_0), \quad \phi \circ [y_m^1] = 0, \quad m \neq i, j,$$

where: y_i^1, y_j^1 are the two cycles defined in section 2.1 and coming from the ovals ν_1, ν_2 ; and $[y^1]$ is the fundamental class corresponding to the upper half orientation. In particular, ϕ can be chosen in a way that $\lambda(q_0) = 1$.

2.3 Imagine cycles. This construction contains less information but it is more general than the others. It is applied to any $\mathbf{Z}/2 \times \mathbf{Z}/2$ action. We are applying it to Y^+ . There, such an action is generated by Conj_1 and Conj_2 .

Let y_1 and y_2 be two components of $Y_{\mathbf{R}}^k$, $k = 1$ or 2 . Assume that C' is dividing and there is a smooth arc $\Lambda \subset X_{\mathbf{R}}^{\bar{k}+}$, $\bar{k} = 3-k$, which connects two points $q_1 \in \partial\pi(y_1)$ and $q_2 \in \partial\pi(y_2)$.

Connect q_1 and q_2 by a smooth arc Σ in one half of C' . Lift Λ to a smooth arc $\tilde{\Lambda}$ connecting in Y the pull backs \tilde{q}_1 and \tilde{q}_2 of q_1 and q_2 . Since Y^+ is simply connected (see 1.4), the loop γ formed by $\tilde{\Lambda}$ and Σ bounds in Y^+ . Let D be an oriented surface in Y^+ with $\partial D = \gamma$. The combined cycle $(1 + \operatorname{Conj}_k)(1 - \operatorname{Conj}_{\bar{k}})D$ represents an element $s(D) \in H_2(Y)$.

Proposition 14. *Let C' be dividing. In the above notation, $s(D) \in H'_+$ if $k = 1$ and $s(D) \in H''_+$ otherwise. For a component y of $Y_{\mathbf{R}}^k$, $s(D) \circ [y] = 0 \pmod{4}$ if y does not contain any of q_j and $\pm 1 \pmod{4}$ if y contains one and only one of them. It holds*

$$s(D) \circ s(D) = 0 \text{ or } 2 \pmod{4}$$

if, respectively, a complex orientation of $C'_{\mathbf{R}}$ at q_1 and q_2 is directed to the same or opposite sides of Λ . Moreover, for two imagnate cycles $s(D)$ and $s(D')$ in generic mutual position

$$s(D) \circ s(D') = 2([\Lambda \circ \Lambda'] + [\Sigma \circ \Sigma']) \pmod{4}.$$

The proof is by straightforward calculation of the orbits of intersection (or self-intersection) points. The result is contained in Lemmas 2 – 4 in [20].

2.4 Mixed cycles. Such cycles are built out of $Y_{\mathbf{R}}$ and some surfaces in Y invariant simultaneously under Conj_1 and Conj_2 (such an invariance implies the invariance under the deck transformation of $Y \rightarrow X$).

Let us fix $k = 1$ or 2 . Let $F^j, 1 \leq j \leq s$, be smooth oriented surfaces embedded in Y which intersect each other transversally and satisfy the following conditions:

- (i) the intersection points lie outside $(Y^+ \cap Y^-) \cup Y_{\mathbf{R}}^k$, each F^j is transversal to $\partial Y^+ = \partial Y^-$ and, thus, $F^{j,+} = F^j \cap Y^+$ and $F^{j,-} = F^j \cap Y^-$ are oriented surfaces with common boundary $\partial F^{j,+} = \partial F^{j,-} = F^j \cap \partial Y^{\pm}$;
- (ii) for every j the real part $F_{\mathbf{R}}^j = F^j \cap Y_{\mathbf{R}}^k$ of F^j divides F^j in two halves Φ_+^j and $\Phi_-^j = \text{Conj}_k \Phi_+^j$ with $F_{\mathbf{R}}^j$ as the common boundary;
- (iii) the sum of the fundamental classes of $F_{\mathbf{R}}^j$ corresponding to the boundary orientation determined by Φ_+^j realizes $0 \in H_1(Y_{\mathbf{R}}^k; \mathbf{Z})$;
- (iv) for each j the tangent bundle of $Y_{\mathbf{R}}^k$ restricted to $\partial \Phi_{\pm}^j$ contains a field K of nonempty open convex cones of lines such that all the complex directions generated by the elements of K are transversal to F^j (in particular, K does not contain the directions tangent to $\partial \Phi_{\pm}^j$) and at the points of $\partial \Phi_{\pm}^j \cap \partial Y^{\pm}$ the real directions tangent to $\partial Y_{\mathbf{R}}^k$ belong to K .

Note, that the condition (iv) and the orientability of F^j are satisfied if $F^{j,+}$ and $F^{j,-}$ are holomorphic.

Equip $\Phi_+^j, 1 \leq j \leq s$, with the orientation inherited from F^j and Φ_-^j with the opposite one. Denote by F and Φ_\pm the oriented surfaces which are the union of F^j and, respectively, Φ_\pm^j over all $1 \leq j \leq s$. Then $[\Phi_-] = \text{Conj}_k[\Phi_+]$.

Under conditions (i)–(iii), there exists a 2-dimensional singular cycle $[N]$ which is an integral combination of the fundamental cycles of the closures of the connected components of $Y_{\mathbf{R}}^k \setminus F$ and which satisfies the relation $\partial[N] = -\partial[\Phi_+] - \partial[\Phi_-]$. Let us denote by n_N the corresponding integral valued function on $Y_{\mathbf{R}}^k$ and set

$$\xi = [\Phi_+] + [N] + [\Phi_-].$$

Proposition 15. *For any $F = \cup_j F^j$ with F^j satisfying the conditions (i)–(iv),*

$$\xi^2 = [F]^2 + \int_{Y_{\mathbf{R}}^{k-}} n_N^2(x) d\chi(x) - \int_{Y_{\mathbf{R}}^{k+}} n_N^2(x) d\chi(x);$$

and, for any j ,

$$\xi \circ [y_j^k] = \int_{y_j^k \cap Y_{\mathbf{R}}^{k-}} n_N(x) d\chi(x) - \int_{y_j^k \cap Y_{\mathbf{R}}^{k+}} n_N(x) d\chi(x).$$

The integrals above are taken against Euler characteristic (see, for example, [27]).

Proof. Due to Proposition 10, the components of $Y_{\mathbf{R}}^k$ are orientable. Hence, $\partial\Phi_\pm$ is two sided in $Y_{\mathbf{R}}^k$. Pick a nonzero section ν_1 of the field K (see (iv) above) on $\partial\Phi_\pm$ which is tangent to $\partial Y_{\mathbf{R}}^{k\pm}$ on $\partial\Phi_\pm \cap \partial Y^\pm$. It is everywhere tangent to $Y_{\mathbf{R}}^k$ and transversal to $\partial\Phi_\pm$. Extend ν_1 to a section ν_1^+ of the tangent vector field of $Y_{\mathbf{R}}^+$ and a section ν_1^- of the tangent vector field of $Y_{\mathbf{R}}^-$ respecting the following conditions: ν_1^\pm are nowhere zero on $\partial Y_{\mathbf{R}}^\pm$; ν_1^ϵ is directed inside $Y_{\mathbf{R}}^\epsilon$ on the components β of $\partial Y_{\mathbf{R}}^\epsilon \setminus \partial\Phi_\pm$ where ν_1 is directed inside β and ν_1^ϵ is directed outside $Y_{\mathbf{R}}^\epsilon$ on the other components of $\partial Y_{\mathbf{R}}^\epsilon \setminus \partial\Phi_\pm$; ν_1^+ and ν_1^- restricted to $\partial Y_{\mathbf{R}}^\pm$ have equal components tangent to $\partial Y_{\mathbf{R}}^\pm$ and their normal components are opposite.

Due to these conditions and (iv), multiplying ν_1^+ and ν_1^- by $\sqrt{-1}$ (in respective natural complex structures on Y^\pm) we get a continuous vector field ν_2 on $Y_{\mathbf{R}}$ which is transversal to N^\pm and F on $\partial\Phi_\pm$. The numbers ξ^2 and $\xi \circ [y_j^k]$ are degree 2 or 1 polynomials in the index of ν_2 and obstruction for extending ν_2 to Φ_\pm . It remains to use the fact that $Y_{\mathbf{R}}^{k\pm}$ are totally real with respect to the complex structure of Y^\pm (cf. Proposition 8). \square

Consider a smooth Conj-invariant oriented surface G in X which meets $S = C'_\mathbf{C} \cap \hat{C}_\mathbf{C}$ transversally. Let U be a simply connected domain in $B_\mathbf{R}$ or in $\hat{B}_\mathbf{R}$ (f.e., U can be the interior of $B_\mathbf{R}$). Pick a Conj-invariant function $f : U \rightarrow \mathbf{C}$ such that $f = 0$ defines S in U and $f \geq 0$ in $\pi(Y_\mathbf{R}^k) \cap U$. Then over a regular neighborhood $T(U)$ of U the covering $Y \rightarrow X$ is given by the standard projection $V \rightarrow T(U)$, $V = \{z^2 = f\} \subset \mathbf{C} \times T(U)$, and $\text{Conj}_k = \text{Conj} \times \text{Conj}$ on V .

Assume that the covering surface $F = \pi^{-1}(G)$ is divided by $F_\mathbf{R} = F \cap Y_\mathbf{R}$ into two halves Φ_+ and Φ_- with $\partial\Phi_+ = \partial\Phi_- = F_\mathbf{R}$. An orientation of F induces an orientation on Φ_+ , which, in its turn, defines an orientation of $\partial\Phi_+$. In particular, $\{z \geq 0\} \cap \pi^{-1}(G_\mathbf{R}) \cap Y_\mathbf{R}^k \subset \partial\Phi_+$ becomes oriented. We descend the latter orientation via projection into an orientation of $G_\mathbf{R} \cap \pi(Y_\mathbf{R}^k)$.

Proposition 16. *Let G and U be as above. If at each point of $G_\mathbf{R} \cap S$ the tangent planes of G and their orientations are complex, then the introduced orientations of the connected components of $G_\mathbf{R} \cap \pi(Y_\mathbf{R}^k)$ alternate when moving along $G_\mathbf{R}$ in U .*

Proof. Same as for the alternating rule for the complex orientations of the real part of the Riemann surface of a function $z = \sqrt{\prod(x - a_i)}$, see [20, Lemma 8]. \square

Remark. The condition on the tangent planes and their orientation can be replaced by the hypothesis that G is holomorphic in U .

Let us introduce one auxiliary notation. It is applied to smooth curves g, g' in $X_\mathbf{R}$ intersecting transversally and equipped with alternating orientations of $g \cap U \cap \pi(Y_\mathbf{R}^k)$ and $g' \cap U \cap \pi(Y_\mathbf{R}^k)$, where, as above, U is a simply connected domain in $B_\mathbf{R}$ or $\hat{B}_\mathbf{R}$. If $q \in X_\mathbf{R} \setminus \pi(Y_\mathbf{R}^k)$ is an intersection point of g with g' and $q \in U$, put $w(q) = 1$ if the compound orientation of $g \cap U \cap \pi(Y_\mathbf{R}^k)$ and $g' \cap U \cap \pi(Y_\mathbf{R}^k)$ alternate when moving along g to p and then along g' out of p , and put $w(q) = -1$ otherwise.

Proposition 17. *Suppose that $F = \cup F^j$, $1 \leq j \leq s$, where the family F^j satisfies the conditions (i)–(iv) and each F^j is the pull-back of an orientable surface $G^j \subset X$ satisfying the hypotheses of Proposition 16. If all the singular points of F belong to $B_\mathbf{R} \cup U$, U being a simple connected domain of $\hat{B}_\mathbf{R}$, then*

$$[F]^2 = 2 \sum_j [G^j]^2 + 4 \sum_{q \in B_\mathbf{R}} w(q) - 4 \sum_{q \in U} w(q) ,$$

where q runs over all intersection points of G^j .

For two mixed cycles ξ, ξ' , constructed by means of the corresponding objects $F, G = \cup G^j, \Phi_{\pm}, N, n_N, U$ and $F', G' = \cup G'^j, \Phi'_{\pm}, N', n_{N'}, U' = U$, respectively, assume, in addition, that any two irreducible components of G and G' meet transversally and only at points belonging to $(B_{\mathbf{R}} \cup U) \setminus \pi(Y_{\mathbf{R}}^k)$. Then

$$\xi \circ \xi' = 2 \sum_{q \in B_{\mathbf{R}}} w(q) - 2 \sum_{q \in U} w(q) + \int_{Y_{\mathbf{R}}^{k-}} n_N n_{N'}(x) d\chi(x) - \int_{Y_{\mathbf{R}}^{k+}} n_N n_{N'}(x) d\chi(x) ,$$

where q runs over all intersection points of surfaces G, G' .

Proof. Same as in [20, Lemma 10] and similar to the proof of Proposition 15.

§3. PROHIBITIONS VIA LATTICE CALCULATIONS

In this section we prohibit most of the remaining schemes of M -smoothings of a Sirlir cusp singularity (see Summary in the end of §1). To prohibit them we apply the constructions from Section 2 to get some special sublattices in $H_2(Y)$. The prohibitions come from analysis of their inertia indices and discriminants. Often, the lattices obtained are isomorphic to $A_n, n \in \mathbf{N}$, the standard integral negative definite lattice of $\text{rk} = n$ generated by elements $e_i, 1 \leq i \leq n$, with $e_i^2 = -2$ and $e_i \circ e_j = 1$ for $|i - j| = 1$ and 0 for $|i - j| > 1$.

Typically, the construction of cycles is preceded by application of the Bézout theorem to specially selected straight lines and conics.

3.1 Prohibitions for smoothing with non-empty oval.

Lemma 6. *There is no smoothing of type (2.1d), (2.1e), (2.1f), except, perhaps,*

$$(3.1) \quad (1\langle a_1 \rangle \sqcup a_2; 0, 1, 1), \quad a_1 = 10, 6, \text{ or } 2 .$$

Proof. Let C' be a smoothing of type (2.1d), (2.1e), or (2.1f) (recall that $b_1 \leq b_2 \leq b_3$). Without loss of generality assume that all the ovals of C' are in a sufficiently small ball $B_0 \subset B$, each non-closed arc of C' crosses ∂B_0 at 2 points, and the real straight lines intersecting B_0 cross $C'_{\mathbf{R}}$ near $\partial B_{\mathbf{R}}$ at ≤ 1 point. Fix a point q on the non-closed arcs of C' as shown in Figure 8, consider the pencil of real straight lines through q , denote by Q the minimal segment of this pencil, containing all lines which intersect empty ovals inside the non-empty one, and denote by R the minimal segment of this pencil, containing all the lines which intersect ovals in the domain \mathcal{B}_3 (it may be empty if $b_3 = 0$).

Proposition 18. *The lines $L \in Q$ do not intersect ovals lying outside the non-empty oval. The lines $L \in R$ do not intersect ovals lying outside the domain \mathcal{B}_3 .*

Proof. If the first statement is violated, one obtains the situation shown in the right drawing in Figure 9. Then the conic passing through q and intersecting the four empty ovals indicated has ≥ 16 common points with C' in contradiction to Lemma 1.

Assume that the second statement is violated. Then, up to switching q to q' , we have either the situation shown in the left drawing in Figure 9, or that in the left drawing in Figure 12, or that in Figure 11. In the first two cases the conics shown contradict Lemma 1. In the last case the straight line passing through the two ovals meets C' at ≥ 8 points, which contradicts Proposition 2. \square

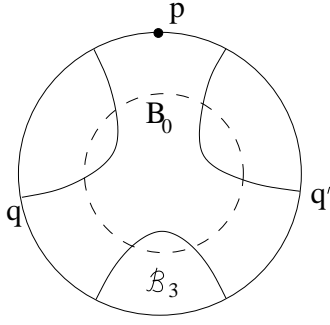

FIGURE 8

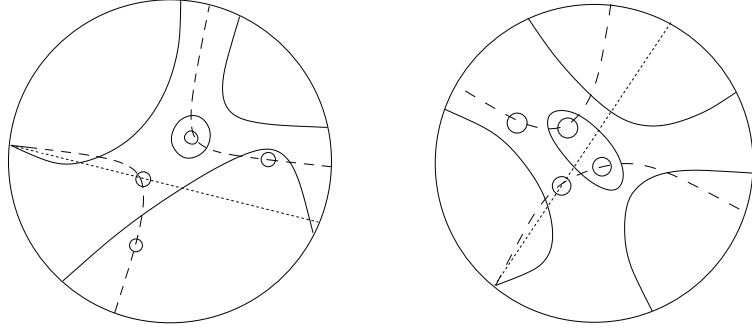

FIGURE 9

Now, using Proposition 18, the construction of real and almost real cycles presented in subsections 2.1, 2.2, and Propositions 11 and 12, one obtains a sublattice of type $A_{2a_1-1} \oplus A_{2b_3-1}$ if $b_3 > 0$, or a sublattice of type A_{2a_1-1} if $b_3 = 0$ in H'_+ . According to Proposition 9, this implies

$$\text{ind}_-(H'_+) = 9 + \chi_0 = 2(a_1 + b_1 + b_2 + b_3) - 3 \geq 2(a_1 + b_3) - 2 \quad \text{if } b_3 > 0,$$

$$\text{ind}_-(H'_+) = 9 + \chi_0 = 2(a_1 + b_1 + b_2 + b_3) - 3 \geq 2a_1 - 1 \quad \text{if } b_3 = 0,$$

which contradicts $b_1 \leq b_2 \leq b_3$, and thus completes the proof of Lemma. \square

Lemma 7. *There is no smoothing of type (3.1).*

Proof. Let C' be a smoothing of type (3.1). First, construct a mixed cycle as described in 2.4. Pick a point q_0 in the disc bounded by an empty oval inside the

non-empty one, and consider the pencil \mathcal{P} of real straight lines through q_0 . Let $L'_1, L'_2 \in \mathcal{P}$ be the tangents to the non-closed arcs bounding the domains $\mathcal{B}_1, \mathcal{B}_2$ such that the interval $(L'_1, L'_2) \subset \mathcal{P}$ consist of lines which do not meet the non-closed arcs indicated. Denote by $L_1, L_2 \in \mathcal{P}$ the lines close to L'_1, L'_2 , respectively, and intersecting the above non-closed arcs in two real points (see Figure 10).

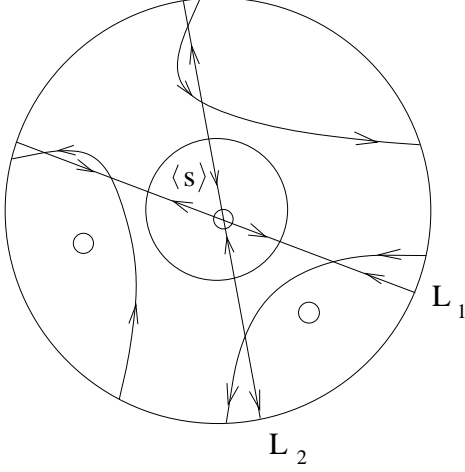

FIGURE 10

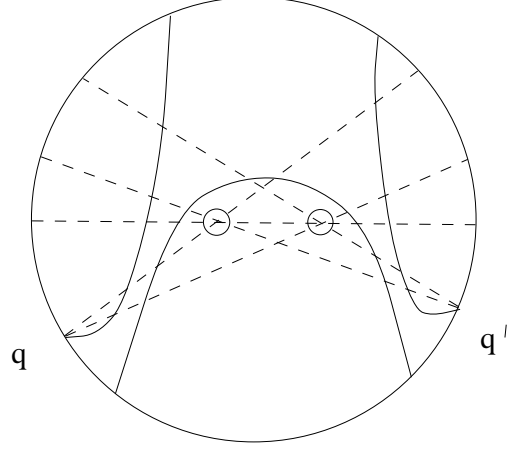

FIGURE 11

Without loss of generality, one can suppose that q_0 is the singular point of C and that the gluing diffeomorphism $\varphi : \partial B \rightarrow \partial \hat{B}$ defining X takes $\partial(L_1)_{\mathbf{C}}$ and $\partial(L_2)_{\mathbf{C}}$ to $\partial(\hat{L}_1)_{\mathbf{C}}$ and $\partial(\hat{L}_2)_{\mathbf{C}}$, where \hat{L}_1, \hat{L}_2 are the strict transforms of L_1, L_2 in \hat{B} . Thus, for every $j = 1, 2$, we get a sphere $G^j = (L_j)_{\mathbf{C}} \cup (\hat{L}_j)_{\mathbf{C}} \subset X$ meets $S = C'_{\mathbf{C}} \cup C_{\mathbf{C}}$ at eight points which are all real. Hence $F^j = \pi^{-1}(G^j) \subset Y$ is a surface of genus 3. It is invariant with respect to Conj_1 and Conj_2 , $F^j_{\mathbf{R}} = Y^2_{\mathbf{R}} \cap F^j$ consists of four ovals and divides F^j into two halves, Φ^j_+ and Φ^j_- , cf. 2.4.

Proposition 19. *Under proper orientations of Φ^1_+ and Φ^2_+*

$$[\partial\Sigma_1^+] + [\partial\Sigma_2^+] = 0 \in H_1(Y_{\mathbf{R}}^2) .$$

Proof. From Proposition 16 applied to $G = G^1 \cup G^2$ and $U = B_{\mathbf{R}}$ it follows that Φ^1_+ and Φ^2_+ can be oriented in a way that the associated orientations of the connected components of $((L_1)_{\mathbf{R}} \cup (L_2)_{\mathbf{R}}) \cap \pi(Y^2_{\mathbf{R}})$ are as in Figure 10. Under this choice of orientations, there exists an oriented part $N \subset Y^2_{\mathbf{R}}$ such that $[\partial N] = [\partial\Phi^1_+] + [\partial\Phi^2_+]$. \square

To finish the construction of the mixed cycle take N as in the proof of Proposition 19 and lying over

$$\bigcup_{L \in [L_1, L_2]} L_{\mathbf{R}} \cap Y_{\mathbf{R}}^2,$$

where $[L_1, L_2] \supset [L'_1, L'_2]$. Then put

$$\xi = [\Phi_+^1] + [\Phi_-^1] + [\Phi_+^2] + [\Phi_-^2] + 2[N].$$

Note that N is contained in $Y_1^2 \cup Y_2^2$ and denote $\Delta_1 = N \cap Y_1^2$, $\Delta_2 = N \cap Y_2^2$.

Proposition 20. *One has*

$$\xi^2 = 8s, \quad \xi \circ [y_2^2] = \pm 4s, \quad [y_2^2]^2 = 2(a_1 - 1),$$

where s is the number of empty ovals bounding from inside the domain $\pi(\Delta_2)$.

Proof. The third formula is contained in Proposition 11. The second one follows from Proposition 15: the only nontrivial contribution in the integrals is given by Δ_2 where $n_N = 2$ and, thus, $\xi \circ [y_2^2] = -2\chi(\Delta_2) = \pm 4s$. To calculate ξ^2 we apply Propositions 15, 17: the contribution of $2(\Delta_1 + \Delta_2)$ is

$$4(-\chi((\Delta_1 \cap Y^+) \cup \Delta_2) + \chi(\Delta_1 \cap Y^-)) = 8s,$$

the contribution of self intersections of $\Phi_+^1 + \Phi_-^1$ and $\Phi_+^2 + \Phi_-^2$ is 4, and the contribution of $(\Phi_+^1 + \Phi_-^1) \cap (\Phi_+^2 + \Phi_-^2)$ is -4 by the definition of $w(q)$. \square

By Proposition 20 the classes $\xi, [y_2^2]$ generate a sublattice in H_+'' , which is positive definite if $0 < s < 2a_2 - 1$, and is positive semidefinite if $s = 0$ or $2a_2 - 1$. Since $\text{ind}_+(H_+'') = 1$ by Proposition 9, to complete the proof of Lemma 7, it remains to show that $\xi, [y_2^2]$ are linearly independent for the cases $s = 0$ and $s = 2a_2 - 1$.

Assume that $s = a_2 - 1$. One should show that $[\xi] \neq \pm 2[y_2^2]$.

Pick a smooth arc $\lambda \subset \mathcal{A}$, which does not intersect L_1, L_2 , and C' and joins a point $p_1 \in \partial \mathcal{B}_2$ and a point p_2 on the non-empty oval such that $p_1, p_2 \notin \pi^{-1}(\Delta_1 \cup \Delta_2)$. The construction in 2.3 provides us with an imagnate cycle c such that $\xi \circ c \equiv 0 \pmod{2}$, while $[y_2^2] \circ c \equiv 1 \pmod{2}$ according to Proposition 14.

Assume that $s = 0$. Then one has to show that $[\xi] \neq 0$.

Consider the pencil segment Q . Proposition 18 and the rule of orientations in a pencil [5] imply that $a_1^+ - a_1^- = 0$ in the notation of Lemma 2. The formulae

(1.4), (1.5) imply that one of the ovals in $\mathcal{B}_2 \cup \mathcal{B}_3$, say, that in \mathcal{B}_3 , is oriented negatively with respect to the boundary of \mathcal{B}_3 . Then the same rule of orientations applied to the pencil generated by L_1, L_2 shows that there exist empty ovals in \mathcal{A} swept by lines $L \in [L_1, L_2]$. Now we pick up a point p_1 on such an oval, a point p_2 on the boundary of $\pi(\Delta_1 \cup \Delta_2)$, join them by an arc $\lambda \subset B_{\mathbf{R}} \setminus (C'_{\mathbf{R}} \cup (L_1)_{\mathbf{R}} \cup (L_2)_{\mathbf{R}})$ and construct an imagnate cycle c . By Proposition 14

$$[\xi] \circ [\pi^{-1}(D \cup \text{Conj}(D))] \equiv 2 \pmod{4},$$

which completes the proof of Lemma 7. \square

3.2 Prohibitions of smoothings of type $(a; 0, 0, b_3)$.

Lemma 8. *There is no smoothing of type (2.1a), (2.1b), (2.1c) with $b_1 = b_2 = 0$.*

Proof. Let C' be a smoothing of type (2.1a), (2.1b), or (2.1c).

As in the proof of Lemma 6, suppose that all the ovals of C' are in a small ball $B_0 \subset B$, consider the pencil of straight lines through the point q and the minimal segment R of this pencil containing all the lines which intersect ovals in \mathcal{B}_3 . Denote by R' the analogous segment of the pencil of lines through the point q' (see Figure 8).

Proposition 21. *Each $L \in R \cup R'$ intersects at most one oval of C' .*

Proof. Such a line crosses the non-closed arcs of C' at ≥ 4 points and the result follows from Lemma 2. \square

Let us orient R clock-wise, and R' counter clock-wise. This defines an ordering \mathcal{O} (resp. \mathcal{O}') on the set s (resp., s') of ovals swept by the lines $L \in R$ (resp., $L \in R'$).

Proposition 22. (1) $(s, \mathcal{O}) = (s', \mathcal{O}')$.

(2) *The ovals in \mathcal{B}_3 form not more than two maximal sequences (with respect to $\mathcal{O} = \mathcal{O}'$) non-interrupted by the ovals from \mathcal{A} .*

Proof. (1) First, note that $\mathcal{O} = \mathcal{O}'$ on the ovals in \mathcal{B}_3 , since otherwise there exist two ovals in \mathcal{B}_3 , located as shown in Figure 11, and a line through these ovals intersects C' at ≥ 8 points, contradicting Proposition 2.

Therefore, if $(s, \mathcal{O}) \neq (s', \mathcal{O}')$, we have one of the situations shown in Figure 12 (up to exchanging q and q'). Consider a conic K through the points q, q' ,

intersecting the three ovals indicated. By Cayley's lemma, $K \cap B_{\mathbf{R}}$ consists of two branches and their intersection with the non-closed arcs of C' is determined by the configuration of the straight lines indicated. Then $(K \cdot C'_{\mathbf{R}}) \geq 16$, which contradicts Lemma 1.

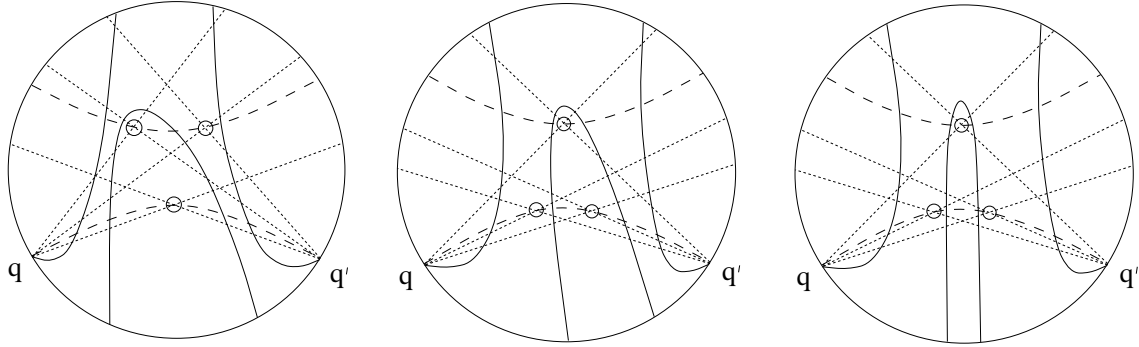

FIGURE 12

(2) Assuming that the sequence of ovals in \mathcal{B}_3 is interrupted at least twice, we have one of the situations shown in Figure 13 (up to exchanging q, q'). By Cayley's lemma and due to the arrangement of straight lines through the four ovals indicated, the conic K , passing through q and these ovals, must go as shown in Figure 13, which implies $(K \cdot C'_{\mathbf{R}}) \geq 15$, contradicting Lemma 1. \square

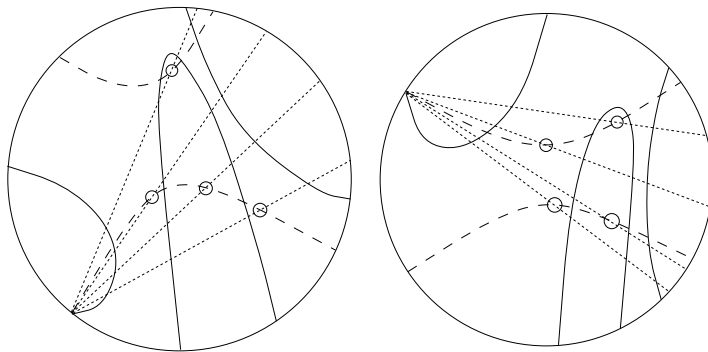

FIGURE 13

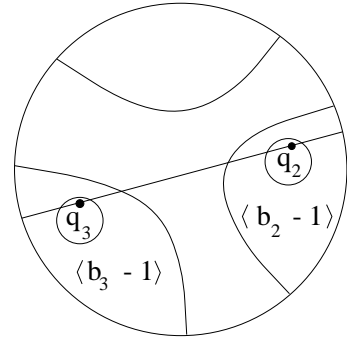

FIGURE 14

By Proposition 22, we have either one non-interrupted sequence of b_3 ovals in \mathcal{B}_3 , or two non-interrupted sequences of b'_3 and b''_3 ovals in \mathcal{B}_3 , $b'_3 + b''_3 = b_3$. Hence, the construction of real cycles and almost real cycles in a pencil gives us a sublattice of type A_{2b_3-1} , or $A_{2b'_3-1} \oplus A_{b''_3-1}$ in H'_+ , which implies the contradiction

$$2b_3 - 1 \leq \text{ind}_-(H'_+) = 2b_3 - 3, \quad \text{or} \quad 2b'_3 - 1 + 2b''_3 - 1 = 2b_3 - 2 \leq \text{ind}_-(H'_+) = 2b_3 - 3,$$

completing the proof of Lemma. \square

3.3 Prohibitions of smoothings of type $(a; 0, b_2, b_3)$, $b_2, b_3 > 0$.

Lemma 9. *There is no smoothing of type (2.1a), (2.1b), (2.1c) with $b_1 = 0$, $b_2 b_3 > 0$.*

Proof. Assume that C' is a smoothing of C of type (2.1a), (2.1b), or (2.1c) with $b_1 = 0$, $b_2 b_3 > 0$.

Let a straight line L intersect an oval in \mathcal{B}_2 and an oval in \mathcal{B}_3 (let us call these ovals ν_2 , ν_3 , respectively), and not separate any two ovals from $\mathcal{B}_2 \cup \mathcal{B}_3$ in $B_{\mathbf{R}}$ (see Figure 14). Fix points $q_2, q_3 \in L$ inside ν_2 , ν_3 , respectively, denote by Q_i the pencil of real straight lines through q_i , $i = 2, 3$, and introduce the minimal segments $P_i \subset Q_i$, containing the lines which intersect ovals in the domain \mathcal{B}_{5-i} , $i = 2, 3$. An orientation of P_i defines an ordering on the set V_i of ovals swept by lines $l \in P_i$, $i = 2, 3$.

Proposition 23. *One of the following statements holds.*

- (1) *The set V_i contains only ovals from \mathcal{B}_{5-i} , $i = 2, 3$.*
- (2) *The set V_3 contains only ovals from \mathcal{B}_2 . The set V_2 contains all the ovals from \mathcal{B}_3 and a non-empty set V_0 of ovals in \mathcal{A} . The sequence of ovals from \mathcal{B}_3 is interrupted by the ovals in V_0 exactly once. The line L separates in $B_{\mathbf{R}}$ the ovals in V_0 from the rest of the ovals in the domain \mathcal{A} .*
- (3) *The statement (2) with the indices 2 and 3 exchanged.*

Proof. First, note that V_i contains no oval from \mathcal{B}_i , $i = 2, 3$. Indeed, otherwise we have one of the situations shown in Figures 15a, b. In the situation 15a the straight line L' crossing the two ovals indicated meets C' at ≥ 9 points contradicting Proposition 1. In the situation 15b the conic K going through the four ovals indicated and the point q meets C' at ≥ 15 points, which contradicts Lemma 1.

Assuming that both V_2 and V_3 contain ovals in \mathcal{A} , one should have the situation shown in Figure 15c, where the conic through the five ovals indicated meets C' at ≥ 15 points which contradicts Lemma 1.

If V_2 contains a non-empty set V_0 of ovals in \mathcal{A} , and the straight line through ν_2 and an oval $v \in V_0$ separates in $B_{\mathbf{R}}$ two ovals from \mathcal{B}_3 , then so does the straight line through v and the point q . Indeed, otherwise we have one of the situations

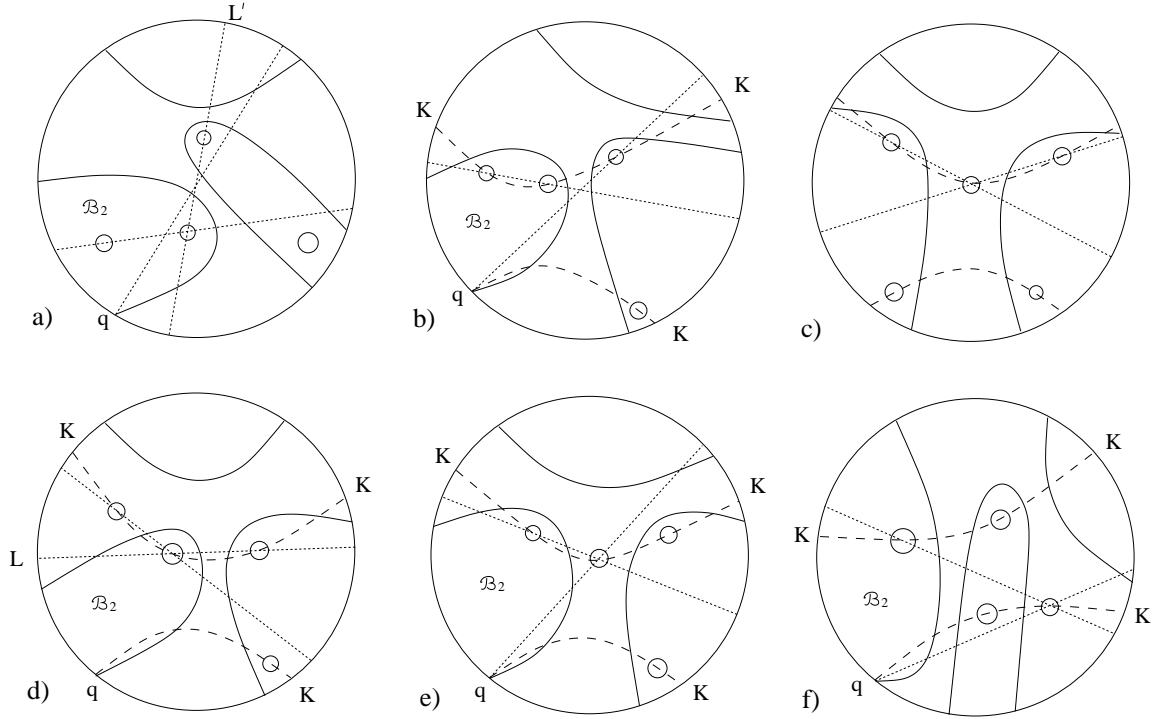

FIGURE 15

shown in Figures 15d, f, e. In each case the conic through the four ovals indicated and the point q meets C' at ≥ 15 points which contradicts Lemma 1. Then we finish the proof of Proposition 23 as it was done in the proof of Proposition 22 by application of Lemma 1 shown in Figure 13. \square

If the statement (1) of Proposition 23 holds true, one takes the real 2-cycles in Y generated by the ovals in $\mathcal{B}_2 \cup \mathcal{B}_3$, and the almost real cycles, constructed by means of the pencils P_2, P_3 , and obtains a sublattice in H'_+ isomorphic to $A_{2b_2-1} \oplus A_{2b_3-1}$, according to Proposition 11 and Corollary 4. Hence

$$2b_2 - 1 + b_3 - 1 = 2(b_2 + b_3) - 2 \leq \text{ind}_-(H'_+) = 2(b_2 + b_3) - 3,$$

which is absurd, completing the proof of Lemma 9 in the case considered.

Assume that the statement (2) of Proposition 23 holds true, V_0 contains $a_1 \geq 1$ ovals and V_2 contains two non-interrupted sequences of ovals of lengths b'_3, b''_3 , where $b'_3 + b''_3 = b_3$.

First, we prohibit certain dispositions of ovals by constructing a mixed cycle which together with $[y_1^2]$ generates a positive sublattice in H''_+ in contradiction with $\text{ind}_+(H''_+) = 1$ (see Proposition 9). Let L' be a straight line through the point q crossing an oval $\nu_0 \in V_0$. Rotate the line L' around a point on ν_0 keeping two real

intersection points with the boundary of \mathcal{B}_2 and making L' close to a tangent to C at the singular point (see Figure 16a, b). Then we can assume that the proper transform $\hat{L}' \subset \hat{B}$ of L' crosses \hat{C} and the exceptional divisor E as shown in Figure 16c. Following the procedure set up in 2.4, we take $F^1 = \pi^{-1}(L'_C \cup \hat{L}'_C)$, $F^2 = \pi^{-1}(E_C)$. Clearly, F^1, F^2 satisfy the conditions (i)-(iv) in 2.4 with $k = 2$. Then we choose halves Φ_+^1, Φ_+^2 of F^1, F^2 , respectively, so that to obtain the orientations of the components of $(L'_R \cup \hat{L}'_R) \cap \pi(Y_R^2)$ and $E_R \cap \pi(Y_R^2)$ as shown in Figure 16a, b, c. We claim that $6[\partial\Phi_+^1] + 2[\partial\Phi_+^2] = 0 \in H_1(Y_R^2)$. Indeed, the latter 1-cycle is the boundary of the 2-cycle N combined from the closures of the components of $Y_R^2 \setminus (F^1 \cup F^2)$ with the multiplicities indicated on their projections to X in Figure 16a, b, c (we assume that these components have the orientation induced from Y_R^2). Now we can define the class

$$[\eta] = 3[\Phi_+^1] + 3[\Phi_-^1] + [\Phi_+^2] + [\Phi_-^2] - [N] \in H_+'' .$$

Remark. The ovals inside $\mathcal{B}_2 \cup \mathcal{B}_3$ are not shown in Figure 16a, b. It easily follows from Proposition 23 and its proof that these omitted ovals are located as follows: (1) in Figure 16a, b_2 ovals are in the part of \mathcal{B}_2 marked with “-1”, b'_3 and b''_3 ovals are in the parts of \mathcal{B}_3 marked with “-5” and “+1”, respectively, (2) in Figure 16b, b_2 ovals are in the part of \mathcal{B}_2 marked with “-1”, b'_3 and b''_3 ovals are in the parts of \mathcal{B}_3 marked with “+5” and “+1”, respectively.

A routine computation based on Propositions 15 and 17 gives

$$(3.2a) \quad [\eta]^2 = 2b_2 + 2b''_3 + 50b'_3 - 56, \quad [\eta] \circ [y_1^2] = -2b_2 + 2b''_3 - 10b'_3$$

in the situation shown in Figure 16a, and

$$(3.2b) \quad [\eta]^2 = 2b_2 + 2b''_3 + 98b'_3 - 80, \quad [\eta] \circ [y_1^2] = -2b_2 + 2b''_3 + 14b'_3 - 12$$

in the situation shown in Figure 16b.

If $a = 1$, then $b_2 + b'_3 + b''_3 = 12$ and the above formulae together with (2) of Proposition 11 always give the nonzero value of the discriminant of the sublattice $\langle [\eta], [y_1^2] \rangle \subset H_+''$. The real cycle y_2^2 coming from the empty oval in \mathcal{A} has self-intersection -2 and is orthogonal to $[\eta], [y_1^2]$; hence the lattice $\langle [\eta], [y_1^2], [y_2^2] \rangle \subset H_+''$ has rank 3 contradicting $\text{rk} H_+'' = 2$ in the case considered, which prohibits all the arrangements with $a = 1$.

If $a = 5$ or 9 , formulae (3.2a, 3.2b) give a nonpositive discriminant of the lattice $\langle [\eta], [y_1^2] \rangle$ only for the following triples (b_2, b'_3, b''_3) :

$$(3.3a) \quad \begin{aligned} & (1, 1, 2), (1, 2, 1), (2, 1, 1), (1, 5, 2), (1, 6, 1), (2, 4, 2), (2, 5, 1), \\ & (3, 4, 1), (4, 1, 3), (4, 2, 2), (4, 3, 1), (5, 1, 2), (5, 2, 1), (6, 1, 1), \end{aligned}$$

for the arrangement shown in Figure 16a, and in the cases

$$(3.3b) \quad (b_2, b'_3, b''_3) = (1, 2, 1), (1, 6, 1),$$

for the arrangement shown in Figure 16b. Thereby, and since $\sigma_+(H''_+) = 1$, the rest of arrangements are prohibited.

Next we construct a full rank sublattice in H'_+ and compute its discriminant, obtaining contradiction whenever this discriminant is not $-2n^2$, $n \in \mathbf{Z}$.

The real 2-cycles in Y generated by the ovals in \mathcal{B}_2 and the almost real cycles constructed by means of the pencil P_3 give classes $\xi_i^2 \in H'_+$, $i = 1, \dots, 2b_2 - 1$. Assuming that they are properly numbered, starting with the class defined by the oval ν_2 , these classes form a standard basis of a lattice of type A_{2b_2-1} :

$$(3.4) \quad (\xi_i^2)^2 = -2, \quad 1 \leq i \leq 2b_2 - 1, \quad \xi_i^2 \circ \xi_j^2 = 1, \quad |i - j| = 1, \quad \xi_i^2 \circ \xi_j^2 = 0, \quad |i - j| > 1.$$

Similarly, the real 2-cycles in Y generated by the ovals in \mathcal{B}_3 and the almost real cycles constructed by means of the pencil P_2 give classes ξ_i^3 , $i = 1, \dots, 2b_3 - 1$, numbered according to the ordering defined by the orientation of P_2 , where ξ_1^3 is generated by the oval ν_3 . By Propositions 11, 12, and Corollary 4, we have (after suitable orientation of the cycles considered)

$$(3.5) \quad (\xi_i^3)^2 = -2, \quad 1 \leq i \leq 2b_3 - 1, \quad i \neq 2b'_3, \quad (\xi_{2b'_3}^3)^2 = 2a_1 - 2,$$

$$(3.6) \quad \xi_i^3 \circ \xi_j^3 = 1, \quad |i - j| = 1, \quad \xi_i^3 \circ \xi_j^3 = 0, \quad |i - j| > 1.$$

Then we complete the above set of classes with $[y_1^1]$ and two more classes obtained from the following mixed cycles τ_0, τ_1 .

For τ_0 we take $G = E_{\mathbf{C}}$, where E is the exceptional divisor in \hat{B} . Let us deform the curve \hat{C} slightly in order to obtain six real intersection points with E (see Figure 17, where the opposite points on $E_{\mathbf{R}}$ should be identified). The surfaces $G \subset X$ and

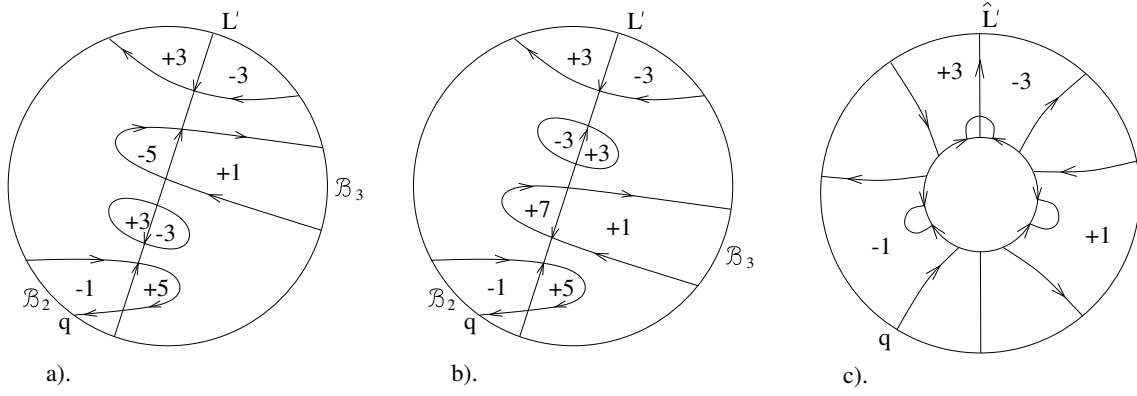

FIGURE 16

$F = \pi^{-1}(G) \subset Y$, clearly, satisfy the conditions (a)-(c) and (i)-(iv) in subsection 2.4, and we can define the cycle

$$\tau_0 = \Phi^+ + \Phi^- + 2(\pi^{-1}(\delta_1) + \pi^{-1}(\delta_2) + \pi^{-1}(\delta_3)),$$

where Φ^+ , Φ^- are presented by the components of $F \setminus Y_{\mathbf{R}}^1$, and $\delta_1, \delta_2, \delta_3$ are the discs bounded by $\hat{C}_{\mathbf{R}}$ and $E_{\mathbf{R}}$, indicated in Figure 17.

For τ_1 we take $G = L_{\mathbf{C}} \cup \hat{L}_{\mathbf{C}}$, where L is the line introduced in the very beginning of this section, and $\hat{L} \subset \hat{B}_{\mathbf{C}}$ is the strict transform of the copy of L in \hat{B} (see Figure 17). The surfaces G and $F = \pi^{-1}(G) \subset Y$ satisfy the conditions (a)-(c) and (i)-(iv) in subsection 2.4. Indeed, (i) and (iv) follow directly from the construction of G and F , (ii) is satisfied, since G is diffeomorphic to the sphere and all the intersection points of G and $S = C'_{\mathbf{C}} \cup \hat{C}_{\mathbf{C}}$ are real, (iii) follows from Proposition 16, establishing the orientation of the components of $G_{\mathbf{R}} \cap \pi(Y_{\mathbf{R}}^1)$ shown by arrows on Figure 17. Hence we can construct the cycle

$$\tau_1 = \Phi^+ + \Phi^- + \sum \pm \Lambda,$$

where λ runs over the closures of all the components of $Y_{\mathbf{R}}^1 \setminus F$ adjacent to F .

Proposition 24. *Orientations of the cycles τ_0, τ_1 can be chosen so that*

- (1) $[\tau_0]^2 = 14, \quad [\tau_1]^2 = 2 + 2a, \quad [\tau_0] \circ [\tau_1] = 0,$
- (2) $[\tau_0] \circ [y_1^1] = 6, \quad [\tau_1] \circ [y_1^1] = 2a + 2 - 4a_1, \quad [y_1^1] \circ \xi_{2b'_3}^3 = 2a_1,$
- (3) *if $b'_3 > 1$ then $[\tau_1] \circ \xi_2^3 = 1$ and $[\tau_1] \circ \xi_{2b'_3}^3 = -2a_1,$*
- (4) *if $b'_3 = 1$ then $[\tau_1] \circ \xi_2^3 = 1 - 2a_1,$*
- (5) *if $b_2 > 1$ then $[\tau_1] \circ \xi_2^2 = 1.$*

All the other intersection indices of $[\tau_0], [\tau_1]$ with $[y_1^1], \xi_i^2, i = 1, \dots, 2b_2 - 1, \xi_i^3, i = 1, \dots, 2b_3$, are zero.

Proof. All the formulae follow from Propositions 12, 13, 15, 16, and 17. Let us show, for example, that $[\tau_0] \circ [\tau_1] = 0$. We fix the orientation of τ_0 so that it coincides with the orientation of y_1^1 on $\pi^{-1}(\delta_i), i = 1, 2, 3$, and fix the orientation of τ_1 so that it coincides with the orientation of y_1^1 on $\pi^{-1}(\delta_1), \pi^{-1}(\delta_2)$ and is the reverse on $\pi^{-1}(\delta_3)$. The corresponding orientations of the components of $E_{\mathbf{R}} \setminus S_{\mathbf{R}}$ and $L_{\mathbf{R}} \cup \hat{L}_{\mathbf{R}} \setminus S_{\mathbf{R}}$, defined in Proposition 16, are shown by arrows in Figure 17. The geometric intersection of τ_0 and τ_1 consists of $\pi^{-1}(\delta_1) \cup \pi^{-1}(\delta_2) \cup \pi^{-1}(\delta_3)$ and two points $\pi^{-1}(E \cap \hat{L})$. The contribution of $\pi^{-1}(\delta_1) \cup \pi^{-1}(\delta_2) \cup \pi^{-1}(\delta_3)$ to the intersection index is 2, and the contribution of $\pi^{-1}(E \cap \hat{L})$ is -2 by Proposition 17. \square

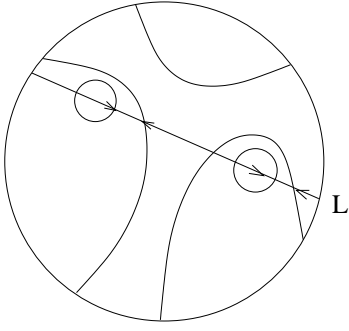

FIGURE 17

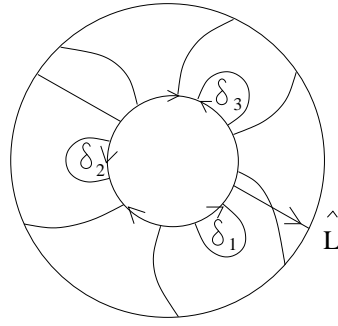

FIGURE 18

Now we obtain a total of $2(b_2 + b_3) + 1 = \dim H'_+$ classes

$$[\tau_0], \quad [\tau_1], \quad [y_1^1], \quad \xi_i^2, \quad i = 1, \dots, 2b_2 - 1, \quad \xi_i^3, \quad i = 1, \dots, 2b_3 - 1.$$

The determinant of the intersection matrix of these classes is a function $\Delta(b_2, b'_3, b''_3, a_1)$ of positive integral variables b_2, b'_3, b''_3, a_1 , satisfying

$$b_2 + b'_3 + b''_3 = 4, \text{ or } 8, \text{ or } 12, \quad a_1 \leq 13 - b_2 - b'_3 - b''_3.$$

The direct computation, based on Propositions 11, 24 and formulae (3.4), (3.5), (3.6), shows that among cases (3.3a, 3.3b) the function Δ takes value $-2n^2, n \in \mathbf{Z}$, only for (b_2, b'_3, b''_3, a_1) in the following list:

$$(3.7) \quad \begin{aligned} & (1, 1, 2, 1), (1, 1, 2, 5), (1, 1, 2, 7), (2, 1, 1, 4), (1, 5, 2, 1), (1, 5, 2, 3), \\ & (1, 5, 2, 4), (2, 4, 2, 4), (2, 4, 2, 5), (4, 1, 3, 2), (4, 1, 3, 4), (4, 3, 1, 2). \end{aligned}$$

In particular, this prohibits (3.3b) and leaves only the situation shown in Figure 16a.

In the cases

$$(3.8) \quad (b_2, b'_3, b''_3, a_1) = (2, 4, 2, 4), (2, 4, 2, 5), (4, 1, 3, 4)$$

one obtains a sublattice $\langle \xi_1^0, \dots, \xi_8^0, [\eta], [y_1^2] \rangle \subset H_+''$, where ξ_1^0, \dots, ξ_7^0 are represented by the real and almost real cycles coming from the chain of four interrupting empty ovals in \mathcal{A} and ξ_8^0 is represented by the real cycle coming from the remaining oval in \mathcal{A} ; η is the mixed cycle constructed above and shown in Figure 16a, c. The nonzero intersections of the 10 classes considered are given by formulae (3.2a) and

$$(\xi_i^0)^2 = -2, \quad i = 1, \dots, 8, \quad \xi_i^0 \circ \xi_{i+1}^0 = 1, \quad i = 1, \dots, 6, \quad [y_1^2]^2 = 10, \quad [\eta] \circ \xi_2^0 = \pm 3.$$

Calculating the discriminant of the lattice $\langle \xi_1^0, \dots, \xi_8^0, [\eta], [y_1^2] \rangle$, one obtains no value $-n^2$, $n \in \mathbf{Z}$, which contradicts $\dim H_+'' = 10$, $\text{discr} H_+'' = -1$, and thus prohibits the cases (3.8). (Note that the similar computation for the case $(b_2, b'_3, b''_3, a_1) = (1, 5, 2, 4)$ gives no prohibition.)

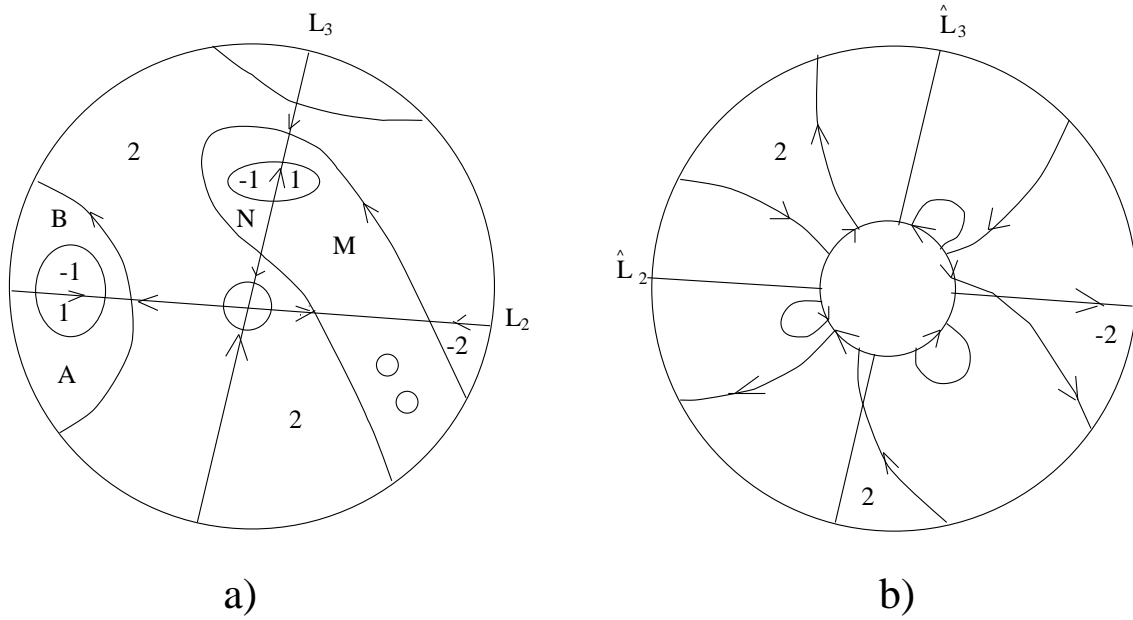

FIGURE 19

To prohibit the rest of cases (3.7) we introduce one more mixed cycle. Fix a point inside an oval $\nu_0 \in V_0$ and draw through this point a straight line L_2 crossing the oval ν_2 , and a straight line L_3 crossing the oval ν_3 (see Figure 19a).

Without loss of generality we can suppose that the point $L_2 \cap L_3$ is the singular point of C , and the strict transforms $\hat{L}_2, \hat{L}_3 \subset \hat{B}$ meet $E_{\mathbf{R}}$ and $\hat{C}_{\mathbf{R}}$ as shown in Figure 19b. The surfaces $F^1 = \pi^{-1}(L_{2,\mathbf{C}} \cup \hat{L}_{2,\mathbf{C}})$, $F^2 = \pi^{-1}(L_{2,\mathbf{C}} \cup \hat{L}_{2,\mathbf{C}})$, clearly, satisfy the conditions (i)-(iv) in 2.4 with $k = 1$. Then we choose halves Φ_+^1, Φ_+^2 of F^1, F^2 , respectively, so that to obtain the orientations of the components of $(L_{2,\mathbf{R}} \cup \hat{L}_{2,\mathbf{R}}) \cap \pi(Y_{\mathbf{R}}^1)$ and $(L_{3,\mathbf{R}} \cup \hat{L}_{3,\mathbf{R}}) \cap \pi(Y_{\mathbf{R}}^1)$ as shown in Figure 19a, b. The 1-cycle $[\partial(\Phi_+^1 + \Phi_-^1 + \Phi_+^2 + \Phi_-^2)]$ is the boundary of the 2-chain N consisting of the closures of connected components of $Y_{\mathbf{R}}^1 \setminus (F^1 \cup F^2)$ taken with multiplicities indicated in Figure 19a, b on the projections of these components on $B_{\mathbf{R}} \cup \hat{B}_{\mathbf{R}}$. Denote the mixed cycle $[\Phi_+^1 + \Phi_-^1 + \Phi_+^2 + \Phi_-^2 - N]$ by ζ and consider the sublattice in H'_+ generated by

$$(3.10) \quad \xi_i^2, i = 1, \dots, 2b_2 - 1, \quad \xi_i^3, i = 1, \dots, 2b_3 - 1, \quad [y_1^1], [\tau_0], [\tau_1], [\zeta].$$

Computations along the formulae in Propositions 15, 17 give

Proposition 25.

- (1) $[\zeta] \circ \xi_i^2 = [\zeta] \circ \xi_j^3 = 0$, $i = 1, \dots, 2b_2 - 1$, $i \neq 2$, $j = 1, \dots, 2b_3 - 1$, $j \neq 2$, $2b'_3$,
- (2) $[\zeta] \circ [y_1^1] = 8 + 4(a'_1 + a'_2)$, $[\zeta] \circ [\tau_0] = 4$, $[\zeta] \circ [\tau_1] = 4(a'_2 - a'_1)$, $[\zeta]^2 = 12 + 8(a'_1 + a'_2)$, where a'_1 is the number of ovals in V_0 different from ν_0 and contained in the real part of ζ , a'_2 is the number of ovals in \mathcal{A} which do not belong to V_0 and are contained in the real part of ζ ,
- (3) if $b_2 > 1$ then $[\zeta] \circ \xi_2^2 = 1$, or -1 , according as the ovals in \mathcal{B}_2 , different from ν_2 , lie in the domain A , or B (see Figure 19a),
- (4) if $b'_3 = 1$ then $[\zeta] \circ \xi_2^3 = 5 + 4a'_1 \pm 2$,
- (5) if $b'_3 > 1$ then $[\zeta] \circ \xi_2^3 = \varepsilon$, $[\zeta] \circ \xi_{2b'_3}^3 = 5 - \varepsilon + 4a'_1 \pm 2$, where $\varepsilon = 1$, or -1 , according as the ovals in \mathcal{B}_3 , different from ν_3 and not separated from ν_3 by L_2 , lie in the domain M , or N (see Figure 19a).

Note that there cannot be ovals both in the domains A and B , or both in M and N . Indeed, first, all ovals in $\mathcal{B}_2, \mathcal{B}_3$ are on one side with respect to the line L passing through the ovals ν_2, ν_3 (see Figure 17). Assuming there there is an oval in the domain A and an oval in B (similarly for M and N), one can easily obtain that the conic crossing these two ovals and the ovals ν_2, ν_3, ν_0 must intersect C' at > 14 points contradicting Lemma 1.

To proceed further we shall specify the position of ovals:

Proposition 26. (1) If $(b_2, b'_3, b''_3) = (2, 1, 1)$ then a'_1 is 0 or $a_1 - 1$.

(2) If $(b_2, b'_3, b''_3) = (1, 1, 2), (1, 5, 2), (4, 1, 3),$ or $(4, 3, 1)$, then $a'_1 = a_1 - 1$.

(3) If $(b_2, b'_3, b''_3) = (1, 5, 2)$ then $a_1 + a'_2$ is even. In particular, there exists a noninterrupting oval in \mathcal{A} which does not belong to the real part of ζ , and one can draw three straight lines L_3, L_4, L_5 through this oval and the ovals ν_0, ν_3 which are located as shown in Figure 20b.

(4) If $(b_2, b'_3, b''_3, a_1) = (2, 1, 1, 4), (4, 1, 3, 2),$ or $(4, 3, 1, 2)$, then there are no ovals in the domain B .

(5) If $(b_2, b'_3, b''_3) = (1, 5, 2)$ then there are no ovals in the components of \mathcal{B}_3 marked by -4 in Figure 20b.

Proof. (1) This follows from Lemma 1. Indeed, assuming the contrary, one can draw a conic intersecting the ovals ν_2, ν_3, ν_0 , two other interrupting ovals in \mathcal{A} , one in the real part of the cycle ζ and the other outside. Due to Cayley lemma, this conic must cross C' at > 14 points, providing a contradiction.

(2) Assuming $a'_1 < a_1 - 1$, one obtains two interrupting ovals in \mathcal{A} such that the straight line through these ovals separates ovals in \mathcal{B}_3 (see Figure 20a). Then one can construct a mixed cycle η_1 in the same way as the mixed cycle η shown in Figure 16 (orientations and multiplicities of the real components of η_1 are indicated in Figures 21a, 16c). Propositions 15 and 17 imply

$$[\eta_1]^2 = 2b_2 + 2b''_3 + 50b'_3 - 50, \quad [\eta_1] \circ [y_1^2] = -2b_2 + 2b''_3 - 10b'_3 + 6,$$

which gives the positive discriminant of the lattice $\langle [\eta_1], [y_1^2] \rangle \subset H''_+$ contradicting $\sigma_+(H''_+) = 1$.

Both (3) and (4) follow from the complex orientation formula $\sum(b_i^+ - b_i^-) = 0$ in Lemma 2, since otherwise, using the straight line pencils centered in the ovals ν_2 and ν_0 and applying the rule of orientations in a pencil [5], one obtains $\sum(b_i^+ - b_i^-) = \pm 2$, thus, a contradiction.

(5) Assume that the last statement is not true. It follows from Cayley lemma and Lemma 1, that all the $b'_3 - 1 = 4$ ovals must be in one of the domains marked by -4 in Figure 20b. Then one constructs a mixed cycle η_2 out of the lines L_3, L_5 and the doubled line L_4 (orientations and multiplicities of the real components of η_2 are indicated in Figure 20b). Calculations based on Propositions 15, 17 give

$[\eta_2]^2 = 132$, $[\eta_2] \circ [y_1^2] = \pm 36$, $[y_1^2]^2 = 10$, hence the discriminant of the lattice $\langle [\eta_2], [y_1^2] \rangle \subset H_+''$ is positive, completing the proof. \square

A nonzero value of the determinant of the intersection matrix for the classes (3.10) prohibits the corresponding arrangement of ovals, since the number of classes (3.10) is greater than $\text{rk}H_+''$. We compute this determinant in the cases (3.7), different from (3.8), under the restrictions imposed by Proposition 26, and obtain nonzero values for all the cases, except for the following two:

$$(3.9) \quad (b_2, b'_3, b''_3, a_1, a'_2) = (1, 5, 2, 1, 3), (1, 5, 2, 4, 0)$$

such that four ovals in \mathcal{B}_3 lie in the domain marked by -2 in Figure 20b.

In the case $(b_2, b'_3, b''_3, a_1, a'_2) = (1, 5, 2, 4, 0)$ we consider the sublattice in H_+'' generated by: $[y_1^2], [\eta], [\eta_2]$; the classes ξ_1^0, ξ_2^0 , represented by the real cycles coming from the oval ν_0 and the oval crossed by the lines L_4, L_5 (Figure 20b); and the classes ξ_i^0 , $i = 3, \dots, 7$, represented by the real and almost real cycles in the chain of the remaining three interrupting ovals in \mathcal{A} . In the case considered,

$$\langle [y_1^2], [\eta], [\eta_2], \xi_1^0, \dots, \xi_7^0 \rangle = \langle [y_1^2], [\eta], [\eta_2] \rangle \oplus A_1 \oplus A_1 \oplus A_5 .$$

From Propositions 15, 17 and formulae (3.2a) we derive

$$[y_1^2] \circ [\eta] = -48, \quad [y_1^2] \circ [\eta_2] = -20, \quad [\eta]^2 = 200, \quad [\eta_2]^2 = 36, \quad [\eta_2] \circ [\eta] = 94,$$

which gives the discriminant $-2^9 \cdot 3^3 \cdot 5^3$ contradicting $\text{rk}H_+'' = 10$, $\text{discr}H_+'' = -1$.

In the case $(b_2, b'_3, b''_3, a_1, a'_2) = (1, 5, 2, 1, 3)$ we have a sublattice in H_+'' generated by classes $[y_1^2], [\eta], [\eta_2]$ and classes $\xi_1^0, \xi_2^0, \xi_3^0, \xi_5^0, \xi_7^0$, represented by the real cycles coming from ovals in \mathcal{A} . Let us construct two more classes in H_+'' represented by imagnate cycles (see section 2.3). Namely, take an arc l_1 (resp. l_2) connecting ovals in \mathcal{A} which give rise to the classes ξ_3^0, ξ_5^0 (resp. ξ_5^0, ξ_7^0), then, following the procedure of section 2.3, construct imagnate cycles representing classes $\tilde{\xi}_4^0, \tilde{\xi}_6^0 \in H_+''$. By Proposition 14,

$$\tilde{\xi}_4^0 \circ \xi_3^0 \equiv \tilde{\xi}_4^0 \circ \xi_5^0 \equiv \tilde{\xi}_6^0 \circ \xi_5^0 \equiv \tilde{\xi}_6^0 \circ \xi_7^0 \equiv 1 \pmod{4}, \quad (\tilde{\xi}_4^0)^2 \equiv (\tilde{\xi}_6^0)^2 \equiv 0 \pmod{2},$$

and the other intersection numbers with $\tilde{\xi}_4^0$ or $\tilde{\xi}_6^0$ are divisible by 4. Direct computation shows that the discriminant of the sublattice

$$\langle [y_1^2], [\eta], [\eta_2], \xi_1^0, \xi_2^0, \xi_3^0, \tilde{\xi}_4^0, \xi_5^0, \tilde{\xi}_6^0, \xi_7^0 \rangle \subset H_+''$$

is $2^9 \pmod{2^{10}}$, which contradicts $\text{rk}H_+'' = 10$, $\text{discr}H_+'' = -1$.

The proof of Lemma 9 is completed.

3.4 Prohibitions for smoothings of type $(a; b_1, b_2, b_3)$, $b_1, b_2, b_3 > 0$. Assume that there exists a smoothing of type $(a; b_1, b_2, b_3)$, $b_1 b_2 b_3 > 0$.

We start with the study of the oval arrangement of such a smoothing.

Proposition 27. *Let q_i be a point inside an oval in \mathcal{B}_i , $i = 1, 2$, and let P_i , $i = 1, 2$, be the minimal segment in the pencil of straight lines through q_i , which contains all the lines intersecting the ovals in \mathcal{B}_3 . Then,*

- (1) *the lines $L \in P_i$ intersect no ovals outside \mathcal{B}_3 , except for the oval embracing q_i , $i = 1, 2$;*
- (2) *suitably oriented segments P_1, P_2 define the same order on the ovals in \mathcal{B}_3 .*

Proof. This can be shown by application of Lemma 1 as in the proof of Proposition 23. For instance, assuming the contrary to the statement (1), we obtain five ovals of C' located as shown in Figure 18. The conic K passing through these ovals must intersect $C'_\mathbf{R}$ in at least 16 points, which is impossible. \square

We order the ovals in each domain \mathcal{B}_i , $i = 1, 2, 3$, as in Proposition 27. Let us choose the first oval ν_i in \mathcal{B}_i , $i = 1, 2, 3$, and three real straight lines L_1, L_2, L_3 in B such that L_i crosses ν_j, ν_k for $i \notin \{j, k\}$, and L_i, L_j with $i \neq j$ meet at a point in \mathcal{B}_k outside ν_k , $k \notin \{i, j\}$ (see Figure 21).

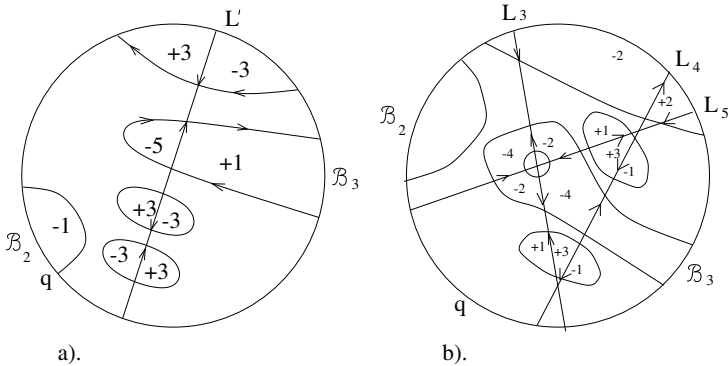

FIGURE 20

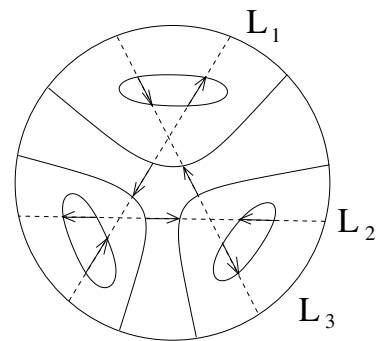

FIGURE 21

The lines L_1, L_2, L_3 divide $B_\mathbf{R}$ into seven domains, which we denote by $B(\varepsilon_1, \varepsilon_2, \varepsilon_3)$, $\varepsilon_1, \varepsilon_2, \varepsilon_3 = \pm 1$, where

$$\varepsilon_i L_i(z) > 0 \quad \text{if} \quad z \in B(\varepsilon_1, \varepsilon_2, \varepsilon_3),$$

and L_1, L_2, L_3 are positive inside the triangle with vertices at the intersection points (see Figure 21). Let $a^{\varepsilon_1\varepsilon_2\varepsilon_3}$ be the number of ovals in $\mathcal{A}^{\varepsilon_1, \varepsilon_2, \varepsilon_3} = B(\varepsilon_1, \varepsilon_2, \varepsilon_3) \cap \mathcal{A}$, and $b_i^{\varepsilon_1\varepsilon_2\varepsilon_3}$ be the number of ovals in $\mathcal{B}_i^{\varepsilon_1, \varepsilon_2, \varepsilon_3} = B(\varepsilon_1, \varepsilon_2, \varepsilon_3) \cap \mathcal{B}_i$ different from ν_i , $i = 1, 2, 3$.

Proposition 28. (1) *At most one of $b_i^{\varepsilon_1\varepsilon_2\varepsilon_3}$ with $\varepsilon_1\varepsilon_2\varepsilon_3 = -1$ and $i = 1, 2, 3$ is different from zero.*

(2) *If $b_3^{-++} > 0$ or $b_1^{+-+} > 0$, then*

$$a^{++-} = a^{-+-} = a^{-++}a^{+--} = a^{-+-}a^{+--} = 0 .$$

(3) *If $b_3^{+++} > 0$ or $b_1^{---} > 0$, then*

$$a^{-+-} = a^{+--} = a^{---}a^{+++} = 0 ,$$

and if $a^{-+-} > 0$ then

$$a^{+-+}a^{-++} = 0 .$$

(4) *The above statements hold for any reenumeration of $\mathcal{B}_1, \mathcal{B}_2, \mathcal{B}_3$.*

Proof. This follows from Bézout's theorem in the form of Lemma 1, because otherwise one can draw a conic intersecting C' at ≥ 15 points. \square

Lemma 10. *There do not exist M -smoothings of types $(a; b_1, b_2, b_3)$, $b_1, b_2, b_3 > 0$, except, perhaps, for the cases*

$$(3.11) \quad \begin{cases} b_1 = b_2 = 1, & b_3 = 2, & a = 9, \\ b_3^{-++} = 1, & a^{+++} = 3, & a^{-++} = 1, & a^{-+-} = 5 \end{cases}$$

$$(3.12) \quad \begin{cases} b_1 = b_2 = 1, & b_3 = 6, & a = 5, \\ b_3^{-++} = 5, & a^{+++} = 1, & a^{-+-} = 4, \end{cases}$$

(up to permutation of indices 1, 2, 3).

Proof. Our plan is to construct $\dim H'_+ + 1$ classes in H'_+ and compute the determinant Δ of their intersection matrix. If $\Delta \neq 0$ then the corresponding smoothing does not exist.

We start with the class $[y_1^1] \in H'_+$.

Then, as in 3.3, we construct the real and almost real 2-cycles coming from the ovals in $\mathcal{B}_1 \cup \mathcal{B}_2 \cup \mathcal{B}_3$ and the corresponding segments of the pencil of lines centered inside the ovals ν_1, ν_2, ν_3 , and which give the classes

$$(3.13) \quad \xi_i^1, \quad i = 1, \dots, 2b_1 - 1, \quad \xi_i^2, \quad i = 1, \dots, 2b_2 - 1, \quad \xi_i^3, \quad i = 1, \dots, 2b_3 - 1,$$

where ξ_1^j is generated by the oval ν_j , $j = 1, 2, 3$. By Proposition 27, these classes form the standard basis in a sublattice $A_{2b_1-1} \oplus A_{2b_2-1} \oplus A_{2b_3-1} \subset H'_+$ which is orthogonal to $[y_1^1]$.

Four more classes in H'_+ are represented by the following mixed cycles τ_0, τ_1, τ_2 , and τ_3 . Taking a smoothing C' closer to C , we may suppose that the three points where L_i meet are arbitrarily close to the singular point q_0 of C . Then there are three lines L'_1, L'_2, L'_3 close to L_1, L_2, L_3 and such that they pass through q_0 , and there is an equivariant diffeomorphism $\psi : B_{\mathbf{C}} \rightarrow B_{\mathbf{C}}$ close to identity which is identical on $C \cup (1 - \epsilon)B_{\mathbf{C}}$, preserves the spheres concentric to $B_{\mathbf{C}}$, and transforms $L'_i \cap \partial B_{\mathbf{C}}$ in $\varphi(L_i \cap \partial B_{\mathbf{C}})$, where φ is the gluing diffeomorphism defining X . Denote by $\hat{L}_1, \hat{L}_2, \hat{L}_3 \subset \hat{B}$ the strict transforms of L'_1, L'_2, L'_3 . Now we construct τ_0, τ_1 exactly as in the proof of Lemma 9: the role of L is played here by L_1 . The cycles τ_2, τ_3 are constructed in the same manner as τ_1 by substituting the line L_1 for the lines L_2, L_3 , respectively. The orientations of the cycles τ_1, τ_2, τ_3 are chosen in correspondence with the orientations of components of $(L_{1,\mathbf{R}} \cup L_{2,\mathbf{R}} \cup L_{3,\mathbf{R}}) \cap \pi(Y_{\mathbf{R}}^1)$ shown in Figure 21.

Thus, we obtain a total of $2(b_1 + b_2 + b_3) + 2 = \dim H'_+ + 1$ classes (3.13) and

$$(3.14) \quad [y_1^1], \quad [\tau_0], \quad [\tau_1], \quad [\tau_2], \quad [\tau_3].$$

Proposition 29.

$$\begin{aligned} [\tau_i]^2 &= 2 + 2a, \quad i = 1, 2, 3; \\ [\tau_i] \circ [\tau_j] &= 2 \sum_{\varepsilon_1, \varepsilon_2, \varepsilon_3 = \pm 1} \varepsilon_i \varepsilon_j a^{\varepsilon_1 \varepsilon_2 \varepsilon_3}, \quad 1 \leq i < j \leq 3; \\ [\tau_i] \circ [y_1^1] &= 2 + 2 \sum_{\varepsilon_1, \varepsilon_2, \varepsilon_3 = \pm 1} \varepsilon_i a^{\varepsilon_1 \varepsilon_2 \varepsilon_3}, \quad i = 1, 2, 3. \end{aligned}$$

If $b_i^{\varepsilon_1 \varepsilon_2 \varepsilon_3} > 0$ and $\varepsilon_1 \varepsilon_2 \varepsilon_3 = -1$, then

$$\xi_2^i \circ [\tau_j] = -\xi_2^i \circ [\tau_k] = \pm 1,$$

where $\{i, j, k\} = \{1, 2, 3\}$. If $b_i^{\varepsilon_1 \varepsilon_2 \varepsilon_3} > 0$ and $\varepsilon_1 \varepsilon_2 \varepsilon_3 = 1$, then

$$\xi_2^i \circ [\tau_j] = \xi_2^i \circ [\tau_k] = \pm 1,$$

where $\{i, j, k\} = \{1, 2, 3\}$. All the intersection indices of $[\tau_1], [\tau_2], [\tau_3]$ with the other classes (3.13), (3.14) are zero.

Proof. Follows from Propositions 12, 15, and 17, as in Proposition 24. \square

Direct computation of the determinant Δ of the intersection matrix of the classes (3.13) and (3.14), based on Propositions 24 and 29, for all the non-negative values of the parameters $a^{\varepsilon_1 \varepsilon_2 \varepsilon_3}, b_i^{\varepsilon_1 \varepsilon_2 \varepsilon_3}, i = 1, 2, 3, \varepsilon_1, \varepsilon_2, \varepsilon_3 = \pm 1$, satisfying

$$\sum_{\varepsilon_1, \varepsilon_2, \varepsilon_3 = \pm 1} \left(a^{\varepsilon_1 \varepsilon_2 \varepsilon_3} + \sum_{i=1}^3 b_i^{\varepsilon_1 \varepsilon_2 \varepsilon_3} \right) = 13,$$

$$\sum_{\varepsilon_1, \varepsilon_2, \varepsilon_3 = \pm 1} a^{\varepsilon_1 \varepsilon_2 \varepsilon_3} = 1 \quad \text{or} \quad 5 \quad \text{or} \quad 9,$$

and the conditions of Proposition 28, shows that $\Delta \neq 0$ except for the cases (3.11), (3.12) (up to renumeration of \mathcal{B}_i), which completes the proof of Lemma 10. \square

The possible arrangement of ovals for smoothings (3.11) and (3.12) left by Lemma 10 is the following:

Proposition 31. *In a smoothing of type (3.11) or (3.12) the ovals are located with respect to the lines L_1, L_2, L_3 and the non-closed arcs as shown in Figure 22. Moreover, no straight line through $L_1 \cap L_2$ and an oval in $\mathcal{A}^{-++} \cup \mathcal{B}_3^{-++}$ separates an oval in \mathcal{A}^{-+-} from L_1 .*

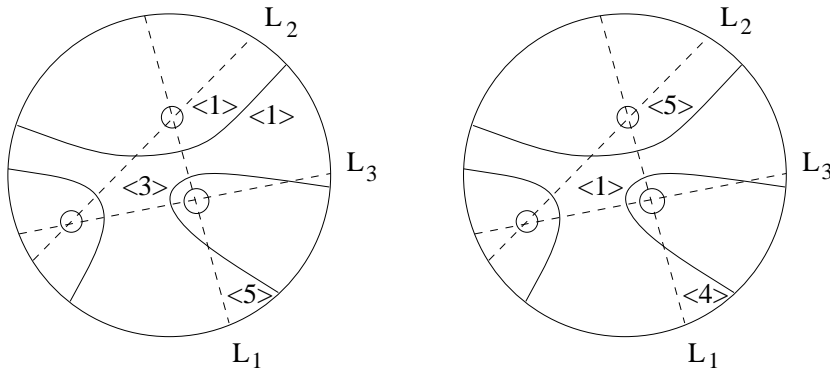

FIGURE 22

Proof. The region \mathcal{A}^{-+-} may consist of two connected components (see Figure 22), but the component of \mathcal{A}^{-+-} , adjacent to the line L_3 , does not contain ovals. Indeed, otherwise one can draw a conic intersecting an oval in that component, ovals ν_1, ν_2, ν_3 , and an oval in \mathcal{B}_3^{-++} , and then show by Cayley's lemma and Lemma 1(2) that such a conic intersects $C'_{\mathbf{R}}$ in at least 16 points.

Similarly, assuming that a straight line through $L_1 \cap L_2$ and an oval from $\mathcal{A}^{-++} \cup \mathcal{B}_3^{-++}$ separates some oval in \mathcal{A}^{-+-} from the line L_1 , one can draw a conic intersecting these two ovals and the ovals ν_1, ν_2, ν_3 , and show by Cayley's lemma and Lemma 1(2) that such a conic intersects $C'_{\mathbf{R}}$ in at least 16 points. \square

§4. APPLICATION OF SEIFERT FORMS

According to the results of §1–3, an M -smoothing C' of a Sirler singularity C can have, if it exists, only the following arrangements of ovals: $(9; 1, 1, 2)$ and $(5; 1, 1, 6)$. Moreover, as it follows from Lemma 10, there exist three lines L_1, L_2, L_3 which are located with respect to C' as is shown in Figure 22.

Without loss of generality we may assume that L_1 and L_2 intersect at the origin of B . Then the pencil $\lambda_1 L_1 + \lambda_2 L_2$ defines on \hat{B} a fibration by disks, $\pi : \hat{B} \rightarrow E = \mathbf{C}P^1$ (here, as before, \hat{B} is B blown up at the origin and E is the exceptional curve). The Euler number of this fibration is -1 . The real part $\hat{B}_{\mathbf{R}}$ of \hat{B} is the Möbius band and $\pi|_{\hat{B}_{\mathbf{R}}}$ is a fibration by segments over $E_{\mathbf{R}} = \mathbf{R}P^1$. We use the same notation for C' and its pull-back to \hat{B} . Note, that, according to our above convention, C' does not go through the origin.

We may assume also that: (1) $C'_{\mathbf{R}}$ is located in $\hat{B}_{\mathbf{R}}$ with respect to the fibers of π as it is depicted in Figures 23 and 24 where the fibers are viewed as vertical lines and $\langle a \rangle$ denotes a horizontal chain of a ovals; (2) the number of the fibers tangent to $C'_{\mathbf{R}}$ is 28 (2 on each oval and 2 on each of two non-closed branches, which is the minimal number of tangent fibers). The part (1) follows from Proposition 31, (2) is achieved by transformation of $C'_{\mathbf{R}}$ described in [14; Prop. 3.5.1]. We suppose, in addition, that no vertical line goes through two ovals. For the group of three ovals in Figure 23 we may suppose this by [14; Prop. 3.5.1], and in other cases it follows from Bézout's theorem. The two ovals $\langle 1 \rangle$ in the Figure 23 are placed one above the other to emphasize that their mutual position with respect to the fibers is unknown. Thus, we have to consider three possibilities: two for Figure 23 and

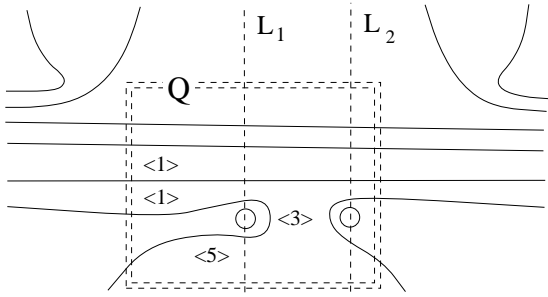

FIGURE 23

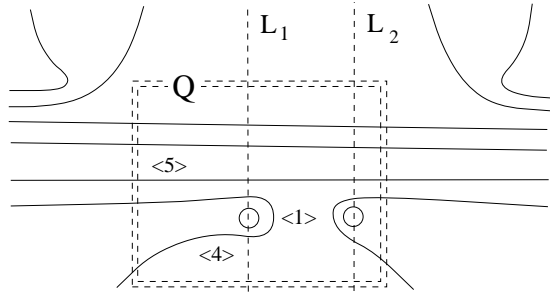

FIGURE 24

one for Figure 24.

The full transform \hat{C} of C in \hat{B} is the sum of E taken with multiplicity 6 and three smooth real curves having a quadratic tangency with E at three distinct real points. The real parts of these three curves are in alternate position with respect to the sides of $E_{\mathbf{R}}$: in an affine system of coordinates (u, v) in \hat{B} with $v = 0$ defining E , these 3 curves are defined by $v = a_i(u - u_i)^2$ with $u_1 < u_2 < u_3$, $a_1 a_2 < 0$, and $a_2 a_3 < 0$.

The smoothing C' , considered as situated in \hat{B} , is a deformation of \hat{C} . Outside a neighborhood of E , it is a small perturbation. Thus, there are three disjoint disks $D_1 \cup D_2 \cup D_3 \subset E$, $v_i \in D_i$ such that $\pi|_{C'}$ is 7-fold over $D_1 \cup D_2 \cup D_3$ and 6-fold outside.

Let $\gamma_\varepsilon, \varepsilon \geq 0$, be a family of simple closed curves lying in one of the components, E^+ of $E \setminus E_{\mathbf{R}}$ on distance ε from $E_{\mathbf{R}}$ ($\gamma_0 = E_{\mathbf{R}}$). Denote by H_ε the closed disk bounded by γ_ε in E^+ . Clearly, $\pi^{-1}(H_\varepsilon)$ are diffeotopic to $\pi^{-1}(H_0)$ inside $\pi^{-1}(H_0)$, at least for small ε , and they are diffeomorphic to a polydisc $D^2 \times D^2$. Denote by S_ε^3 its boundary.

As in [14], we study the surface $N_\varepsilon = C' \cap \pi^{-1}(H_\varepsilon)$. There exists ε_0 such that for $0 < \varepsilon < \varepsilon_0$ the surfaces N_ε are identified by a diffeotopy of $\pi^{-1}(H_\varepsilon)$ and we denote all N_ε with $0 < \varepsilon < \varepsilon_0$ by N as well as omit ε in the notation of other objects. The boundary $K = \partial N$ is a link in S^3 whose isotopy type is determined by $C'_{\mathbf{R}}$ up to some unknown integer parameters.

In what follows we compute the nullity of the Seifert form of K as a function of these parameters and show that any of their values contradict the Murasugi–Tristram inequality for the Euler characteristic of N .

Proposition 32. $\chi(N) = 2$.

Proof. As mentioned in the Introduction, the genus of a Sirler singularity is 13, and hence $\chi(C') = 2 - 2g - r = -27$. Denote by c the number of branching points of $\pi|_{C'} \rightarrow E$ counted with multiplicities. Clearly, $c = c_{\mathbf{R}} + 2c_H$ where $c_{\mathbf{R}}$ (resp. c_H) is the number of branching points lying over $E_{\mathbf{R}}$ (resp. over H). By Riemann – Hurwitz formula, $\chi(C') = 6\chi(\mathbf{C}P^1) + \chi(D_1 \cup D_2 \cup D_3) - c$, and, hence, $c = 42$.

Similarly, $\chi(N) = 6\chi(H) + \chi(H \cap (D_1 \cup D_2 \cup D_3)) - c_H = 6 + 3 - c_H$. According to the assumptions made in this section in what concerns real fibers tangent to $C'_{\mathbf{R}}$, we have $c_{\mathbf{R}} = 28$, and, hence, $c_H = (c - c_{\mathbf{R}})/2 = 7$. Thus, $\chi(N) = 6 + 3 - 7 = 2$. \square

Proposition 33. *The determinant of the symmetrized Seifert matrix of K vanishes.*

Proof. The Murasugi–Tristram inequality [23] states that

$$\text{null}(K) \geq \chi(N) + |\text{sign}(K)|$$

where $\text{null}(K)$ and $\text{sign}(K)$ are respectively the nullity and the signature of the link K . By Proposition 32, this implies $\text{null}(K) \geq 2$. \square

End of the proof of Theorem 1. Here, we find explicitly all the links K which can appear for the smoothings shown in Figures 23, 24 and prove that the determinants of their symmetrized Seifert matrices are non-zero.

Since $\pi^{-1}(H)$ is identified with $D^2 \times D^2$, the sphere $S^3 = \partial\pi^{-1}(H)$ is naturally decomposed into two solid tori $S^3 = T_1 \cup T_2$. In this decomposition, $T_1 = \pi^{-1}(\gamma)$ (recall that $\gamma = \partial H$) and $T_2 = H \times S^1$.

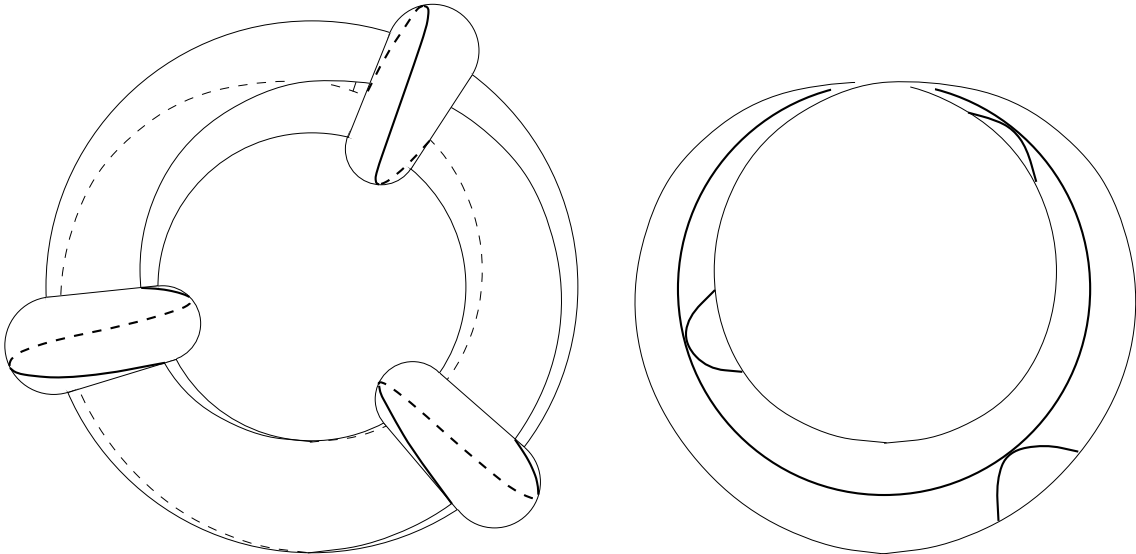

FIGURE 25

The real curve $G := C \cap S_0^3$ (where S_0 is the sphere S_ε for $\varepsilon = 0$) consists of the following seven parts. Four of them, namely, the "core" $E_{\mathbf{R}}$ (the real part of the exceptional curve) and the three parabolas lying on the Möbius band $\hat{B}_{\mathbf{R}}$. The other three pieces are the arcs lying on the surfaces of the "solid half-tori" $((\partial D_i) \cap H) \times S^1$, $i = 1, 2, 3$ (they are subsets of T_2). Note that $\hat{B}_{\mathbf{R}}$ is embedded into $T_1 = D^2 \times S^1$ as a left Möbius band $\{(z, e^{i\varphi}) | e^{-\frac{1}{2}i\varphi} z \in \mathbf{R}\}$.

In the Figure 25 (left) we have depicted the solid torus T_1 , the three solid half-tori with the three pieces of G carried by them, and the Möbius band $\hat{B}_{\mathbf{R}}$. In the Figure 25 (right) we have depicted the Möbius band $\hat{B}_{\mathbf{R}}$ and the four pieces of G carried by it.

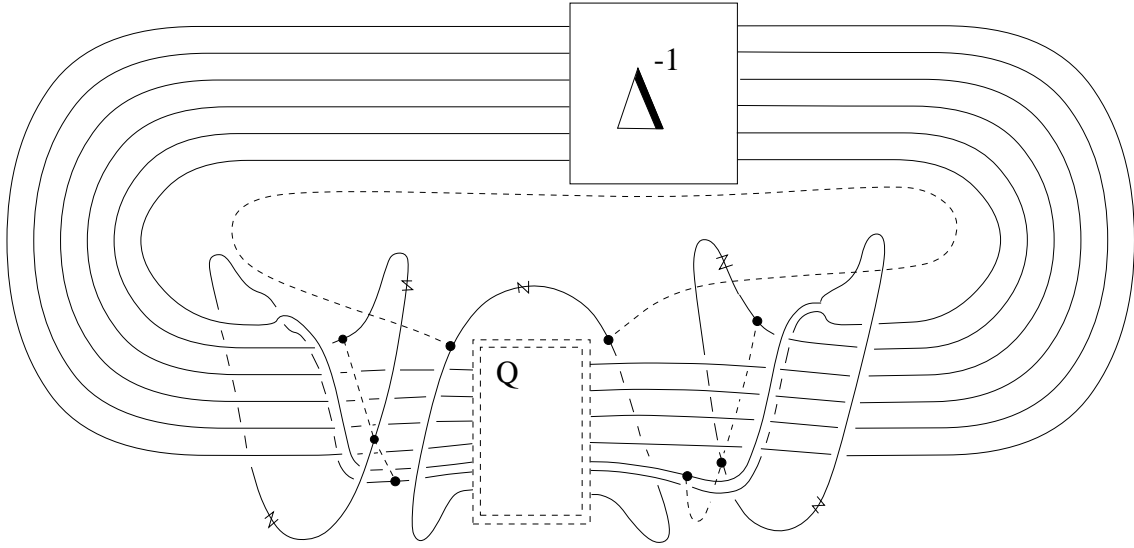

FIGURE 26

The perturbed curve $G' := C' \cap S_0^3$ is obtained from this picture by replacing the core and the three parabolas with the curves shown in Figures 23, 24. And to obtain the link K we apply the procedure described in [14, 3.4, 3.5]. The result is depicted in Figure 26 where the variable pattern Q corresponds to the pattern Q in Figures 23, 24 and contains one of the following three braids:

$$\alpha^{(i)} = \beta^{(i)} \cdot \tau_{1,2} \sigma_2^{-1} \sigma_1^{-1} \sigma_3^{-1} \cdot \left(\prod_{j=1}^{h^{(i)}} \sigma_2^{-1} \sigma_3^{e_j} \sigma_1^{-e_j} \right) \cdot \sigma_3 \sigma_1 \sigma_2^{-1}, \quad i = 1, 2, 3 \text{ where}$$

$$\beta^{(1)} = \tau_{2,3} \sigma_3^{-1} \tau_{3,4} \sigma_4^{-1} \tau_{4,1} \sigma_1^{-5}$$

$$\beta^{(2)} = \tau_{2,4} \sigma_4^{-1} \tau_{4,3} \sigma_3^{-1} \tau_{3,1} \sigma_1^{-5}$$

$$\beta^{(3)} = \tau_{2,4} \sigma_4^{-5} \tau_{4,1} \sigma_1^{-4}$$

and $h^{(1)} = h^{(2)} = 4$, $h^{(3)} = 2$. The braids $\alpha^{(1)}$, $\alpha^{(2)}$, correspond to different mutual positions of $\langle 1 \rangle$'s in Figure 23; the braid $\alpha^{(3)}$ corresponds to Figure 24. In all the cases we use the convention in Figure 27 for the generators σ_j of the braid group; Δ is the Garside element (see Figure 27) $\Delta = \Delta_6 = \Pi_{5,1}\Pi_{5,2}\Pi_{5,3}\Pi_{5,4} \cdot \sigma_5$ where

$$\Pi_{k,l} = \begin{cases} \sigma_k \sigma_{k+1} \dots \sigma_l & \text{if } l > k \\ \sigma_k \sigma_{k-1} \dots \sigma_l & \text{if } l < k \end{cases}$$

and $\tau_{k,l}$ is defined as in [14], by

$$\tau_{k,l} = \begin{cases} \Pi_{l,k+1}^{-1} \Pi_{k,l-1} & \text{if } l > k \\ \Pi_{l,k-1}^{-1} \Pi_{k,l+1} & \text{if } l < k \\ 1 & \text{if } l = k \end{cases}$$

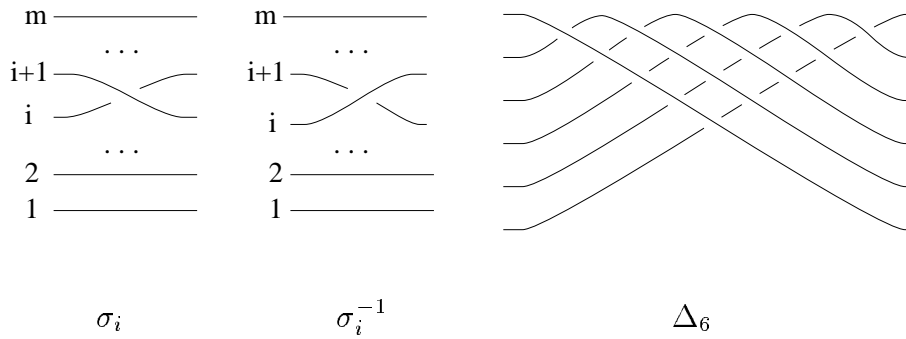

FIGURE 27

In Figure 26 we marked some arcs of K by zigzags. Replacing them by the dashed lines we obtain a link which is a braid on 7 strings

$$\begin{aligned} \Delta_6^{-1} \cdot \Pi_{5,1}^2 \Pi_{6,1} \cdot \alpha^{(i)} \cdot \Pi_{1,6} \cdot \sigma_1 \cdot \Pi_{1,5}^2 &= (\Pi_{5,5}^{-1} \dots \Pi_{5,1}^{-1}) \cdot \Pi_{5,1}^2 \Pi_{6,1} \cdot \alpha^{(i)} \sigma_2 \cdot \Pi_{1,6} \Pi_{1,5}^2 \\ &= \delta^{-1} \left(\sigma_1 \Pi_{6,1} \cdot \alpha^{(i)} \sigma_2^2 \cdot \Pi_{1,6} \cdot \sigma_2 \sigma_1 \sigma_3 \sigma_2 \cdot \sigma_5^{-1} \right) \delta \quad \text{where } \delta = \Pi_{5,3} \Pi_{5,4} \sigma_5 \end{aligned}$$

Using the algorithm from [14, 2.6.5], we have computed the determinant of the Seifert form as a function of the unknown integer parameters e_j . In the two cases in Figure 23 the determinant is (up to a non-zero constant factor)

$$\begin{aligned} d^{(1)} &= -228 + 28e_1 + 64e_2 + 100e_3 + 136e_4 - 9e_1^2 - 32e_2^2 - 41e_3^2 - 36e_4^2 \\ &\quad - 16e_1e_2 - 14e_1e_3 - 12e_1e_4 - 48e_2e_3 - 32e_2e_4 - 52e_3e_4; \\ d^{(2)} &= -1236 - 120e_1 + 36e_2 + 192e_3 + 348e_4 - 85e_1^2 - 324e_2^2 - 381e_3^2 - 256e_4^2 \\ &\quad - 120e_1e_2 - 70e_1e_3 - 20e_1e_4 - 416e_2e_3 - 184e_2e_4 - 348e_3e_4. \end{aligned}$$

Each $d^{(i)}$, $i = 1, 2$ is a quadratic function of e_j whose Hessian is negatively definite and whose value at the minimum is also negative. Hence, the determinant of the Seifert form is non-zero.

In the case of Figure 24 the determinant is

$$d^{(3)} = -180 + 240e_1 - 60e_2 + 109e_1^2 + 256e_2^2 + 76e_1e_2.$$

The equation $d^{(3)} = 0$ has no integer solution.

Thus, in all the cases we obtain a contradiction with Proposition 33. \square

REFERENCES

- [1] V.I. Arnold, *On the distribution of the ovals of real plane curves, involutions of 4-dimensional manifolds, and the arithmetic of integer valued quadratic forms*, *Funct. Anal. and its Appl.* **5** (1971), no. 3, 169-176.
- [2] V.I. Arnold, *Index of a singular point of a vector field, the Petrovski – Oleinik inequality, and mixed Hodge structure*, *Funct. Anal. and its Appl.* **12** (1978), 1-12.
- [3] V.I. Arnold, *Some open problems in the theory of singularities*, Proc. Sobolev Seminar, Novosibirsk, (in Russian, English translation in Proc. Symp. Pure Math., 40, 1983, part 1).
- [4] T. Fiedler, *Eine Beschränkung für die Lage von reellen ebenen algebraischen Kurven*, *Beiträge zur Algebra und Geometrie* **11** (1981), 7-19.
- [5] T. Fiedler, *Pencils of lines and the topology of real algebraic curves*, *Math. USSR Izvestiya* **21** (1983), 161-170.
- [6] D.A. Gudkov and G.A. Utkin, *Topology of curves of the 6th order and surfaces of 4th order*, Uch. Zap. Gor'kov. Univ., Gor'k. Gos. Univ., Gor'ky, 1969 (Russian) (English translation: D.A. Gudkov and G.A. Utkin. *Nine papers on Hilbert's 16th problem* Amer. Math. Soc. Transl (2), vol. 112, AMS, Providence, R.I., 1978).
- [7] D.A. Gudkov, *Topology of real projective algebraic varieties*, *Rus. Math. Surveys* **29** (1974), no. 4, 3-79.
- [8] A. Harnack, *Über die Vielfältigkeit der ebenen algebraischen Kurven*, *Math. Ann.* **10** (1876), 189-199.
- [9] I. Itenberg and O. Viro, *In preparation*.
- [10] V. Kharlamov and J.-J. Risler, *Blowing-up construction of maximal smoothings of real plane curve singularities*, *Real Analytic and Algebraic Geometry* (F. Broglia, M. Galbiati and A. Tognoli, eds.), Proc. Intern. Conf. Trento (Italy), September 21-25, 1992, Walter de Gruyter, Berlin, New York, 1995, pp. 169-188.
- [11] V.M. Kharlamov and O.Ya. Viro, *Extensions of the Gudkov-Rokhlin congruence*, *Lect. Notes Math.*, vol. 1346, 1988, pp. 687-717.
- [12] A.B. Korchagin and E.I. Shustin, *Affine curves of degree 6 and smoothings of ordinary 6th order singular point*, *Math. USSR Izvestia* **33** (1988), no. 3, 501-520.
- [Lo] E. Looijenga, *The discriminant of a real simple singularity*, *Comp. Math.* **37** (1978), 51-62.
- [14] S.Yu. Orevkov, *Link theory and oval arrangements of real algebraic curves*, *Topology*, to appear.
- [15] D. Pecker, *Sur le theoreme local de Harnack*, *C. R. Acad. Sci. Paris, Serie I*, **326** (1998), no. 4, 573-576.
- [16] J.-J. Risler, *Un analogue local du théorème de Harnack*, *Invent. Math.* **89** (1987), no. 1, 119-137.
- [17] V.A. Rokhlin, *Congruences modulo 16 in Hilbert's 16th problem*, *Funct. Anal. and its Appl.* **6** (1972), 301-306.
- [18] V.A. Rokhlin, *Complex orientations of real algebraic curves*, *Funct. Anal. Appl.* **6** (1974), 77-79.
- [19] V.A. Rokhlin, *Complex topological characteristics of real algebraic curves*, *Russian Math. Surv.* **33** (1978), no. 5, 85-98.

- [20] E. Shustin, *New restrictions in topology of real curves of degree divisible by 8*, Math. USSR Izvestiya **37** (1991), no. 2, 421-443.
- [21] E. Shustin, *Topology of real plane algebraic curves*, Proc. Intern. Conf. Real Algebraic Geometry, Rennes, June 24-29 1991, Lect. Notes Math. 1524, Springer, 1992, pp. 97-109.
- [22] E. Shustin, *Smoothings of non-degenerate singular points*, Preprint, Tel Aviv University, 1995.
- [23] A.G. Tristram, *Some cobordism invariants for links*, Proc. Camb. Phil. Soc. **66** (1969), 251-264.
- [24] O.Ya. Viro, *Construction of M -surfaces*, Funct. Anal. Appl. **13** (1979), no. 3, 212-213.
- [25] O.Ya. Viro, *Real algebraic varieties with prescribed topology*, D.Sci. Thesis, Leningrad, 1983 (Russian).
- [26] O.Ya. Viro, *Progress in the topology of real algebraic varieties over the last six years*, Russ. Math. Surv. **41** (1986), no. 3, 55-82.
- [27] O.Ya. Viro, *Some integral calculus based on Euler characteristic*, Lect. Notes Math. **1346** (1988), 127-138.
- [28] G. Wilson, *Hilbert's sixteenth problem*, Topology **17** (1978), no. 1, 53-73.

Address of the authors:

V.M. Kharlamov

IRMA, Université Louis Pasteur et CNRS, 7 rue René-Descartes, 67084 Strasbourg cedex, France.

E-mail: kharlam@math.u-strasbg.fr

S.Yu. Orevkov

Steklov Math. Institute, Vavilova 42, 117966, GSP-1, Moscow, Russia.

E-mail: orevkov@main.domino.msk.ru

E.I. Shustin

School of Math. Sciences, Tel Aviv University, Ramat Aviv, 69978 Tel Aviv, Israel.

E-mail: shustin@math.tau.ac.il