



HAL
open science

Transition matrices for statistical representation of time-varying electrical signals. Application to wind generator currents.

Vanya Ignatova, Seddik Bacha, Pierre Granjon, Z. Styczynski

► To cite this version:

Vanya Ignatova, Seddik Bacha, Pierre Granjon, Z. Styczynski. Transition matrices for statistical representation of time-varying electrical signals. Application to wind generator currents.. DIGESEEC Critical Infrastructures Workshop, 2006, Magdeburg, Germany. 5 p. <hal-00117333v2>

HAL Id: hal-00117333

<https://hal.science/hal-00117333v2>

Submitted on 4 Dec 2006

HAL is a multi-disciplinary open access archive for the deposit and dissemination of scientific research documents, whether they are published or not. The documents may come from teaching and research institutions in France or abroad, or from public or private research centers.

L'archive ouverte pluridisciplinaire **HAL**, est destinée au dépôt et à la diffusion de documents scientifiques de niveau recherche, publiés ou non, émanant des établissements d'enseignement et de recherche français ou étrangers, des laboratoires publics ou privés.



HAL Authorization

STATISTICAL MATRIX REPRESENTATION OF TIME-VARYING ELECTRICAL SIGNALS. APPLICATION TO WIND GENERATOR CURRENTS

Vanya Ignatova, Seddik Bacha, Pierre Granjon, Zbigniew Styczynski***

Laboratory of Electrical Engineering

38402 Saint Martin d'Hères, France

Phone (33) 04 76 82 62 99, Fax (33) 04 76 82 63 00

**Laboratory of Images and Signals, Grenoble, France*

***Institute of Electric Power Systems, Magdeburg, Germany*

E-mail: vanya.ignatova@leg.ensieg.inpg.fr

Keywords: data storage, Markov processes, matrix methods, power quality, power system harmonics, signal prediction, signal reconstruction, statistics, time varying systems

ABSTRACT

The development of the technology over the years and the liberalization of the energy market have brought many technical and economical profits, but they have also modified power system operation. In order to accurately analyze the new operational conditions and characteristics, a voluminous measurement data are required. It is, therefore, very important to store this data in efficient way without losing any important information.

This paper deals with the statistical description of measurement data. A matrix representation is chosen in order to preserve the information about the temporal evolution of the recorded signal. Two matrix forms are investigated: transitions probabilities (Markov) matrix and transitions number matrix. In order to evaluate the degree of preservation of the time information, two applications of the statistical matrices are investigated: reconstruction and prediction. In deed, the availability of the information about the time evolution of the recorded data can be applied to restore the original signal from its corresponding matrix form. Another possible application is the forecasting of the electrical signals behaviour in the future. The methods are illustrated on real measurement data and applied in the case of wind generator measured currents.

1 INTRODUCTION

The time-varying nature of measured voltages and currents is well known and ever present in power systems. It is mainly due to the variability of the non-linear loads operating mode, or well to linear loads with fixed operating conditions, when switching on and off to the grid.

Many recent research interests are focused on the non stationary behaviour of electrical signals and especially on the time-varying nature of the harmonics, an important aspect of the power quality. As the FFT algorithm is not accurate in the harmonic estimation in case of random variations, different techniques for time-varying harmonics assessment have been proposed in the literature: wavelet transform [1], neural network [2], Min norm method and Wigner-Ville distribution [3]. Other recent publications are focused on the probabilistic harmonic analysis, the harmonic summation and propagation in systems with multiple non linear loads [4,5]. Revisions of standards are proposed [6] or even made [7] including probabilistic limits for time-varying harmonic currents and voltages. The application of the actual steady-state harmonic distortion limits to non stationary harmonics is also investigated in [8].

The distributed generation technologies can either improve or deteriorate the level of power system harmonics and the power quality in general. In order to determine their impact on the power quality, a large volume of measurements should be performed and analyzed. One of the major challenges is to represent this voluminous recorded data in statistical terms without losing any important information.

The simplest approach to compress measured data is to describe it by statistical measures: minimum value, maximum value, mean value and standard deviation [9]. A more accurate way to describe a set of measurements in statistical terms is the vector form representation, i.e. the probability density function or well the probability distribution function. The probability density function indicates the frequency of occurrence of the recorded signal values. Its accuracy can be improved by considering the signal as a sum of deterministic and random component [10]. The probability distribution function is the integral of the probability density function. It provides the same information and has the same advantages and drawbacks as the probability density function.

The vector form representation is an easy and efficient way to describe random behaviour of recorded signals. However, information about time evolution of the recorded signal is completely lost. In order to take it into account, a matrix description of the recorded signal should be applied.

This paper deals with the statistical matrix representation of time-varying electric signals. Two matrix forms are investigated. The first one is the transition probability matrix, which terms represent the probability that the signal passes from one value to another. This matrix is also known as Markov matrix and has already been applied in case of non stationary harmonics [11]. The second one is the transitions

number matrix, which represents the number of times the signal has passed from one value to another. The main advantage of the matrix representation with respect to the previous vector form is that it contains information about the temporal structure of the recorded signal. In order to investigate at which point the time information is preserved in the statistical matrices and how it can be exploited, we have used the statistical matrices to reconstruct the original signal and to predict its future behaviour.

This paper is organized as follows. Section 2 deals with the statistical matrix representation of the recorded data in both matrix forms. The derivation of the probability density function and the classical statistical measures from both matrices is also described. Sections 3 and 4 present two applications of the statistical matrix representation: signal reconstruction and signal prediction. In section 3 the signal is stored and then reconstructed from the Markov matrix, the state transitions matrix and the probability density function. In the three cases, the results are presented and analyzed. In section 4 two methods for signal prediction are applied and the results are discussed. Finally, in Section 5 reconstruction and prediction applications of the transition matrices to measured wind generator currents are described.

2 MATRIX REPRESENTATION OF RECORDED DATA

In this section recorded data are statistically described by Markov matrix and transitions number matrix. Both matrices are first defined and then their computation is given in details and illustrated with an example. The derivation of the probability density function and the most important statistical measures from both matrices is finally demonstrated.

2.1 Matrix definition

A Markov chain is a sequence of random variables whose probabilities at a time interval depend upon the values at the previous time. A signal recorded from the real network can be considered as a Markov chain, because its current values depend on its previous values (also called states). The probability that the signal goes to one state to another is called transition probability.

The behaviour of Markov chains is described by the matrix of transitions probabilities, also called Markov matrix. Each element p_{ij} in this matrix represents the probability of transition from a particular state (the matrix row index) to the next state (the matrix column index). Being probabilities, the elements of the Markov matrix take values between 0 and 1. The sum of the probabilities in each row is exactly 1, because from anyone state the system either remains in this state or moves to one of the others:

$$M(i, j) = [p_{ij}], \quad 0 \leq p_{ij} \leq 1 \quad \sum_j p_{ij} = 1 \quad (1)$$

An alternative of the Markov matrix is the transitions number matrix, which elements r_{ij} , as its name indicates, represent the number of transitions between the different states. The elements of the transitions number matrix are always positive or zero:

$$R(i, j) = \lfloor r_{ij} \rfloor, \quad r_{ij} \geq 0 \quad (2)$$

2.2 Matrices estimation

The two previous matrices are easy to compute from successive data. In this section their computation is described and illustrated with an example.

2.2.1 Transitions number matrix

The transitions number matrix can be derived from the recorded data by increasing in each state transition the corresponding matrix element with an increment. The computational process is shown in fig.1, where the states are denoted by S and the number of transitions for state i to state j by r_{ij} . When the data vector is achieved, an additional increment is added to the term corresponding of the transition between the last state and the first one in order to increase the accuracy of the matrix in its reconstruction and prediction applications. The elements r_{ij} are arranged in a matrix form $R(i, j)$; the size of the matrix is determined by the number of signal states (values).

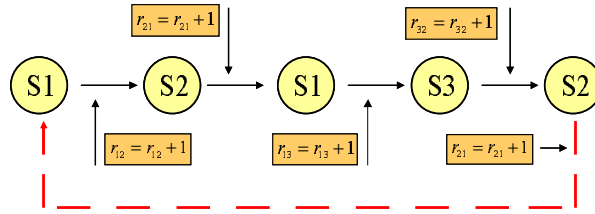

Figure 1: Estimation of the transitions number matrix

2.2.2 Markov matrix

The estimation technique applied for the Markov matrix is described in [12]. First the number of times r_{ij} that the signal has moved from state i to state j is calculated and arranged in a matrix form $R(i, j)$ as previously explained. Then, the probability of transition from state i to state j is estimated by dividing each term r_{ij} by the sum of the elements in the i -th row:

$$M(i, j) = p_{ij} = \frac{r_{ij}}{\sum_{j=1}^n r_{ij}}, \quad (3)$$

where n is the states number.

2.2.3 Example of matrices computation

An example of the previous matrices computation is given in this paragraph. The recorded signal consists of the first voltage harmonic's magnitude acquired at one point of a real power network. The sampling period is 10 min and 144 samples are available, which corresponds to a duration of 24 hours (fig.2).

The recorded signal takes values from $227.536V$ to $237.346V$ during the 24 hours. Considering only its integer values, the signal is characterized by 10 states: $x = \{228, 229, 230, 231, 232, 233, 234, 235, 236, 237\}$, the non integer signal values being rounded. The size of the matrices is determined from the number of states, here 10×10 . Better accuracy can be achieved if a larger number of states is considered, but the size of the matrices will increase and more memory will be required.

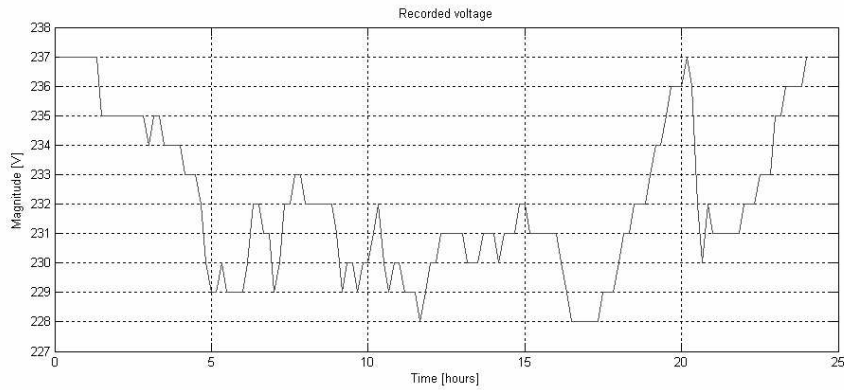
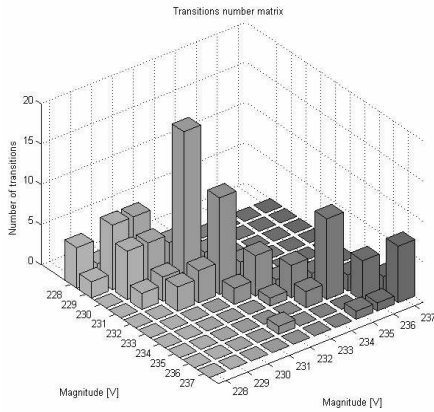
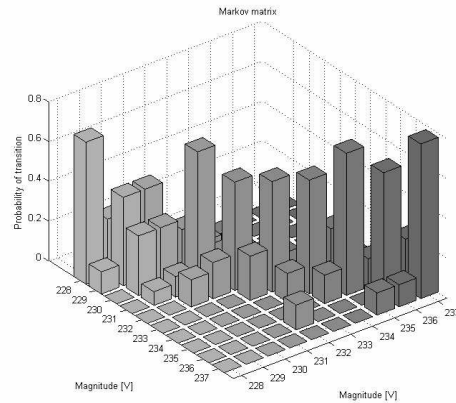

Figure 2: Recorded signal

The computation of the matrices is realized as previously explained. Their structures are graphically presented in fig.3.



a)



b)

Figure 3: Graphical representation of a) the transitions number matrix and b) the Markov matrix

2.3 Available information from the statistical matrices

The classical methods for data storage can be derived from the statistical matrices. The determination of the probability density function p_i from the transition number matrix is presented in (4).

$$p_i = \frac{\sum_{j=1}^n M(i, j)}{n} \quad (4)$$

By knowing the vector of signal states x_i and the probability density function p_i , the statistical measures: mean $E(x)$ and standard deviation σ can be calculated:

$$E(x) = \sum_{i=1}^n p_i x_i \quad (5)$$

$$\sigma = \sqrt{\sum_{i=1}^n p_i (x_i - E(x))^2} \quad (6)$$

In addition to the information provided by classical methods of statistical data storage, the statistical matrices take into account the temporal evolution of the signal. Their structure is relevant for the signal variations: if most part of the matrix elements is situated on or near the main diagonal, the signal is characterized by slow variations. On the contrary, if the main matrix elements are not localized close to the main diagonal, the signal magnitude is characterized by sudden and strong variations. Concerning the signal presented in fig. 2, the corresponding matrices (fig. 3) have almost a diagonal structure, which shows that the signal varies slowly.

The statistical matrices represent an efficient and interpretable way to store recorded data without loss of important information. The information about the probability or the frequency of occurrence of the transitions between the states can be used to reconstruct the signal and to forecast its future evaluation, as described in the next two sections.

3 SIGNAL RECONSTRUCTION

In this section, recorded data are first described by probability density function, Markov matrix and transitions number matrix. Secondly, these three statistical quantities are used to reconstruct the original signal and their performance is compared and discussed.

3.1 Algorithms

As the probability density function does not contain information about the time distribution of the recorded data, the reconstruction of the signal using this quantity

is realized by generation of random numbers having the corresponding probability distribution.

The signal reconstruction using the transitions number matrix begins from an arbitrary-chosen matrix term [13]. Every following signal state is derived from the last one and the matrix element on the corresponded row containing the highest transitions number. For every reconstructed point, the matrix term used for its determination decreases by an increment equal to 1. The described algorithm is the opposite of the one used for the transition numbers matrix estimation shown in fig. 1.

The algorithm of signal reconstruction using Markov matrix is analogous to the one applied in the case of transitions number matrix. The reconstruction of the stored signal starts from the term with the highest probability. After each point determination, the matrix term employed for the reconstruction decreases by an increment value $\frac{N_{st}}{N_{sa}}$, where N_{st} is the states number and N_{sa} is the samples number of the stored signal.

3.2 Results

The real and the reconstructed signals are compared in fig.4 and their corresponding probability density functions are shown in fig.5. The deviations between real and reconstructed signals in the three cases are presented in Table 1 by relative errors in the wave forms, in the probability density functions and in the statistical measures (mean value and variance). In order to compare the dynamics of the different signals, another important parameter is introduced in Table 1: the number of state changes.

The reconstructed signal from the probability density function is random and does not have the same dynamics as the real signal. The deviation between the two wave forms is important. However, the reconstructed signal has very similar probability density function and statistical measures than the real signal.

The reconstructed signal from the Markov matrix has a wave form similar to the wave form of the real signal, but it doesn't have the same probability density function. It is due to the fact that the terms of Markov matrix represent the probability that the system passes from one state to another, but they do not provide information about the frequency of occurrence for the different signal states. The deviation between the statistical measures of real and reconstructed signals is also important.

In the signal reconstruction the transitions number matrix combines the advantages of Markov matrix and probability density function. The restored signal has the same dynamics as the real signal and very similar probability density function and statistical measures.

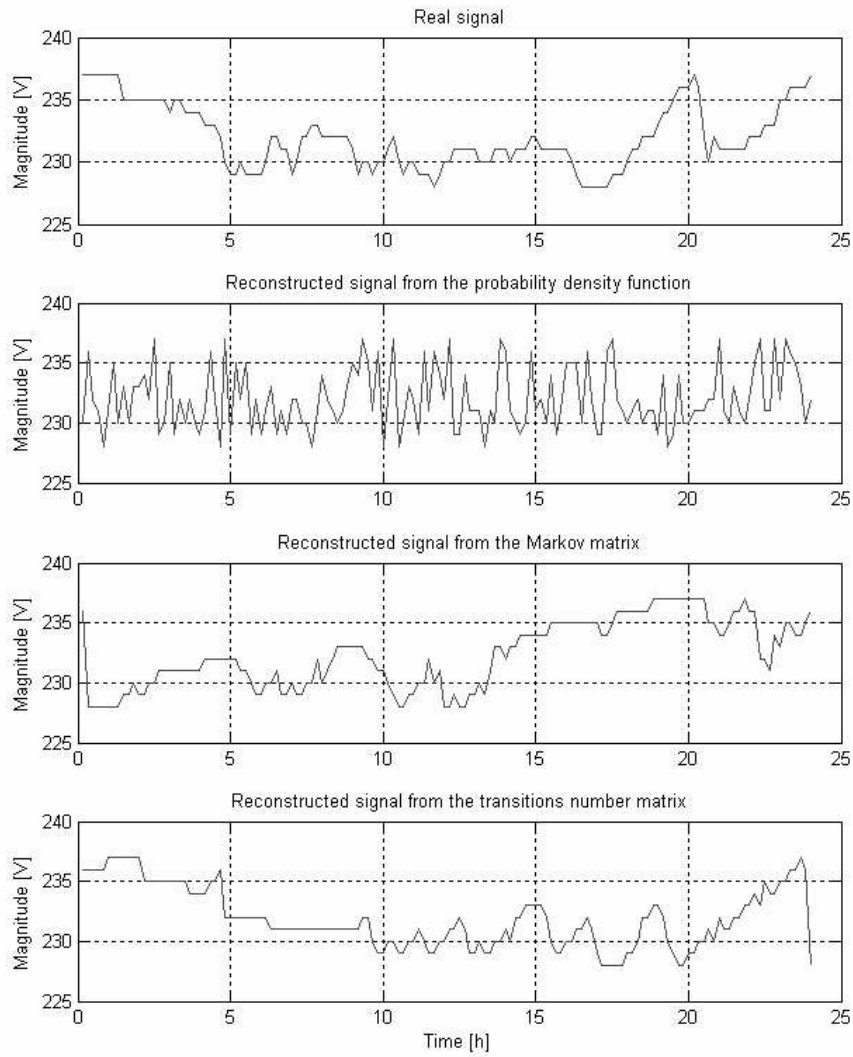

Figure 4: Real and reconstructed signals using the probability density function, the Markov matrix and the transitions number matrix

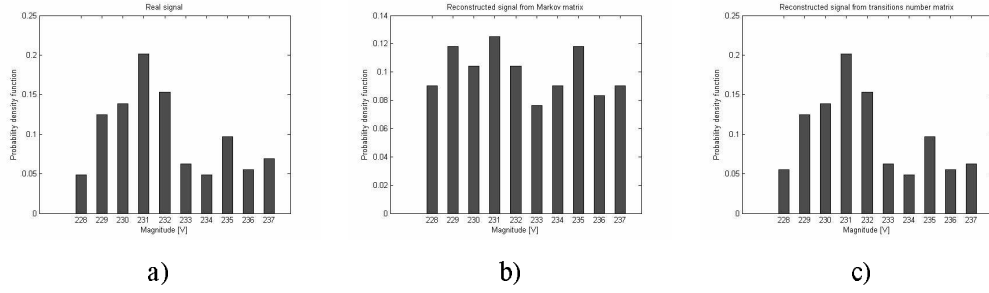

Figure 5: Probability density function for: a) the real signal b) the reconstructed signal from Markov matrix c) the reconstructed signal from transitions number matrix

Table 1: Errors in the reconstruction from Probability density function, Markov matrix and Transitions number matrix

	Real signal	Reconstructed signal		
		Probability density function	Markov matrix	Transitions number matrix
Relative error for the mean value [%]	-	1.1	0.16	0.0269
Relative error for the variance [%]	-	3.02	11.79	0.55
Mean relative error for the wave form [%]	-	1.17	1.09	0.63
Mean relative error for the probability density function [%]	-	2.73	39.4	3.44
Number of states changes (dynamics)	62	144	61	63

The performance of the transitions number matrix can also be analyzed thanks to Table 1, where the results from the three signal reconstruction methods are compared. It can be concluded that the reconstructed signals from the transition matrices have almost the same dynamics. The signal reconstructed from the transition matrix is characterized with minimal errors in the mean value, the variance and the probability density function. However, the time evolution of the original signal and the reconstructed signals is not the same.

4 SIGNAL PREDICTION

Classical signal prediction methods give usually good results, but only for few time steps in the future. They are usually based on the correlation function of the signal (linear prediction, Kalman filter) and give worse results after a certain number of time steps, when the correlation disappears. Markov probabilities are also applied in time series prediction [14], but only for real time forecasting, where the originally forecast values are updated or modified as measured data become available.

Power system harmonics prediction is a subject of interest only if an important number of samples are predicted. In this section, statistical matrices are applied to forecast the future behaviour of harmonics in long term duration.

The prediction of a large number of samples from the previous matrices is investigated. Stochastic and deterministic approaches based on statistical matrices are proposed. Both methods are applied in the case of Markov matrix, the prediction using transitions number matrix being analogous.

The deterministic approach is similar to the method used for signal reconstruction. The prediction of the signal begins from the last measured point of the real signal. Every following signal state is determined from the last state and the term with the highest probability on the corresponding row. After each signal point prediction, a new matrix is computed, decreasing by an increment the matrix term used for the last signal point generation.

In the stochastic approach the signal prediction is realized by a generation of random variables with Gaussian probability distribution. Every next state is determined by the generation of a random number with Gaussian probability distribution corresponding to the previous state. In other words, by supposing that the signal is in the state i , the next state j is determined by:

$$x_j = \sigma_i \text{randn}(1) + \mu_i, \text{ where} \quad (8)$$

randn : function generating random numbers with normal distribution with mean zero and standard deviation 1

μ_i mean value for the state i

σ_i standard deviation for the state i

One of the advantages of the stochastic approach is that it does not need a new matrix computation after each point determination. Although, an important error may be induced due to the fact that the signal is supposed to have a Gaussian distribution in anyone of its states, which is not always valid.

The results obtained from the deterministic and the stochastic approaches are presented in fig.6 and fig.7 respectively. In the chosen example, 1 hour data are used; the sampling time is 30 seconds. The signal behavior is predicted for 1 hour (100 points).

In general, the deterministic approach gives relatively good results when the future signal variations are similar to the variations used for the computation of the Markov matrix. The stochastic approach gives more variables and not always reliable results.

As it can be seen from table II, the deterministic method gives better results than the stochastic one. In both cases the predicted signal is closer to the real signal for small periods of time.

The methods applied for signal prediction from Markov matrix can be used in the case of transitions number matrix. In fact, the transitions number matrix may be reduced to a Markov matrix using equation (3), which allows the application of the same prediction techniques as in the case of Markov matrix.

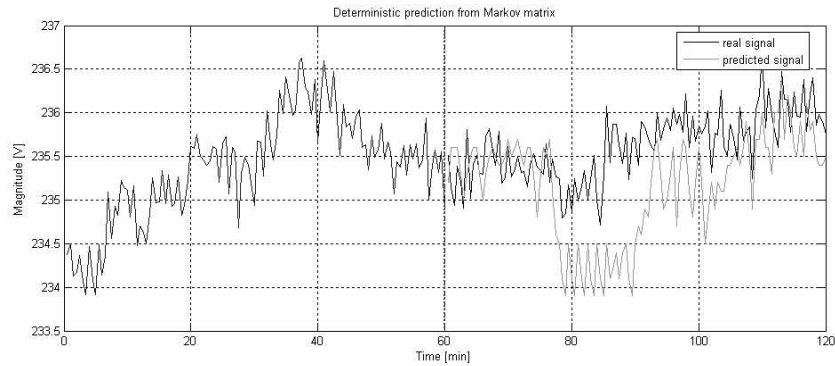

Figure 6: Signal prediction by deterministic approach

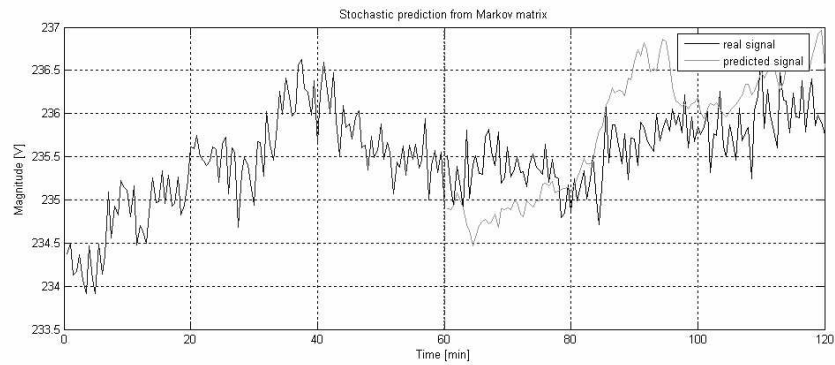

Figure 7: Signal prediction by stochastic approach

Table 2: Mean relative error in the signal predicted from the deterministic and the stochastic approach

	Mean relative error for	
	300 time steps	600 time steps
Deterministic approach	0.16 %	0.18 %
Stochastic approach	0.23 %	0.27 %

5 EXAMPLE OF APPLICATION TO WIND GENERATOR CURRENTS

The transition matrices allow the compression of a large volume of data without loss of important information. They can be applied not only to time-varying harmonics, but also to any time-varying electrical signal.

In this section the transitions matrices are applied to the currents of doubly fed induction wind turbine generator. The wind generator is modelled by a dc motor and doubly fed induction generator (fig 8a). The stator of the induction generator is directly connected to the network and the rotor is connected to the network via an AC/DC/AC converter (fig. 8b).

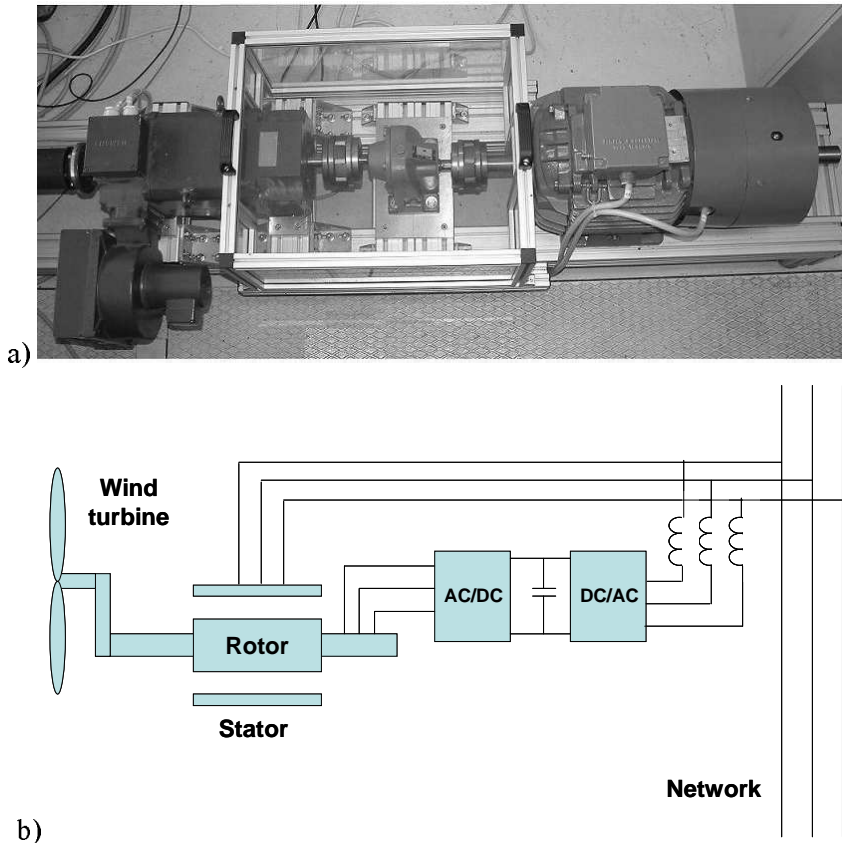

Figure 8: Experimental bench

Rotor currents depend on the speed of the wind and respectively their magnitudes vary with the time: as example, a recorded rotor current magnitude is shown on fig.9. In order to reduce the volume of information, the measured current magnitude is compressed by using Markov matrix and State transitions matrix. The reconstruction of the signal from both matrix forms (fi.9a) proves that there is no loss of lot of information due to the data compression. The rotor current magnitude can

be also well predicted for small periods of time (fig.9b); the errors in the signal prediction increase with respect of the time.

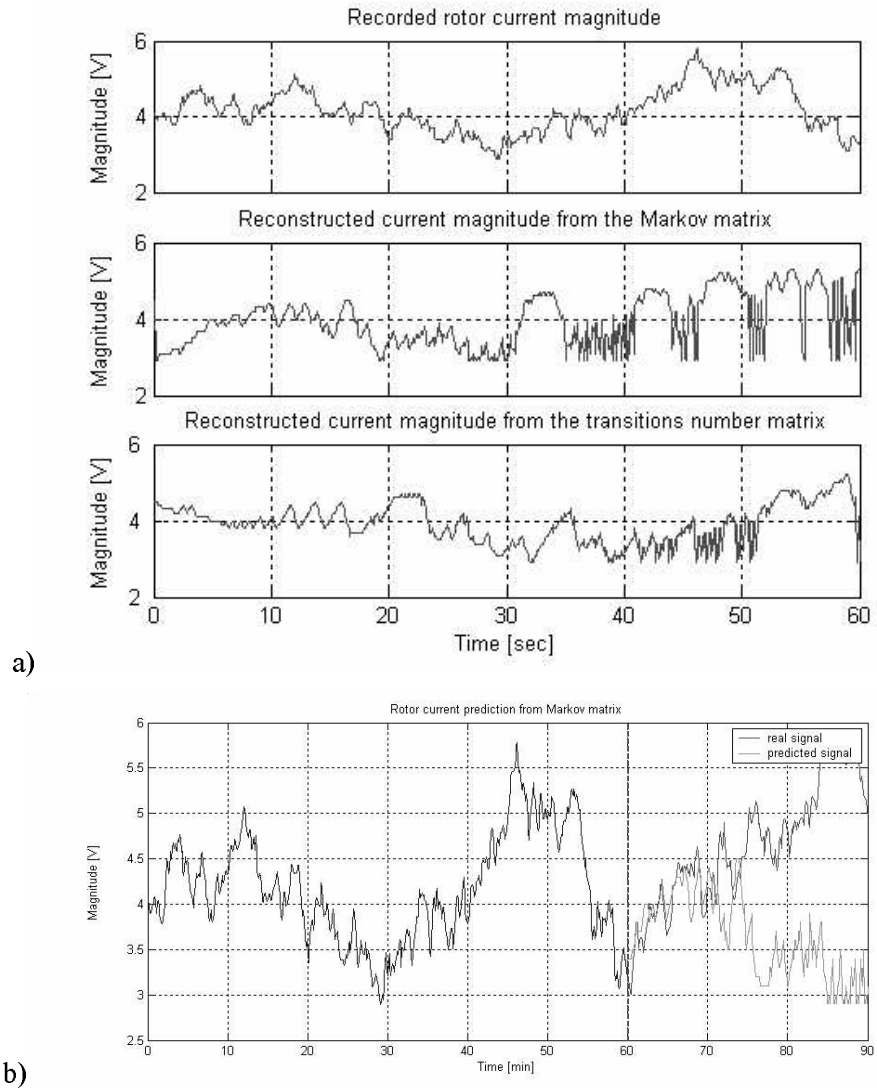

Figure 9: Recorded rotor current and its reconstruction from transition matrices (a); Rotor current prediction from Markov matrix(b)

6 CONCLUSION

Distributed generation, advanced distribution automation and utility deregulation may have a positive or a negative effect on the power quality. Measurements should be performed in order to evaluate their impact.

Measured signals usually present a large volume of data. They can be presented into a compact and easy to exploit form without losing important information by using a statistical matrix description.

Markov matrix and transitions number matrix offer an efficient way to store recorded data. In addition to the usual methods for data storage, these statistical matrices take into account the temporal evolution of the signal, which allows the restitution of the stored signal and the prediction of its future behaviour. They can be successfully applied for the statistical description of power quality disturbances like power system harmonics, voltage variations and voltage dips.

The time information stored in the statistical matrices is used to reconstruct the recorded signal, as well as to know in advance how power system will behave. The reconstructed signals from the statistical matrices have almost the same dynamics and statistical measures as the real signal, but not the same time evolution. In prediction, the obtained results are variable and need a further development.

In general, the proposed algorithms should be applied into a larger number of measured data in order to evaluate accurately their performances. Some parameters like the samples number and the sampling frequency should also be taken into account in the signal reconstruction and prediction.

7 REFERENCES

- [1] Tongxin Z., Makram E.B, Girgis A.A. : *Power system transient and harmonic studies using wavelet transform*, IEEE Transactions on Power Delivery, October 1999, pp. 1461-1468, Vol. 14, Issue 4
- [2] Lai L.L., Tse C.T., Chan W.L., So A.T.P., *Real-time frequency and harmonic evaluation using artificial neural networks*, IEEE Transactions on power delivery, Vol. 14, No. 1, January 1999
- [3] Leonowicz Z., Lobos T., Schegner P., *Modern spectral analysis of non-stationary signals in electrical power systems*, 14th Power System Computation Conference, Sevilla, Spain, June 24-28 2002.CD-ROM, 2002
- [4] Probabilistic Aspect Task Force of the Harmonics Working Group Subcommittee, *Time-varying harmonics: Part II Harmonic summation and propagation*, IEEE Transactions on Power Systems, Vol. 17, No. 1, January 2002
- [5] Carpinelli G., Esposito T., Varlione P., Verde P. ,*First order probabilistic harmonic flow*, IEE Proceedings on Generation, Transmission and Distribution, Vol.148, No. 6, November
- [6] Ribeiro P., Caroinelli G., "IEEE Std 519 Revision : *The need for probabilistic limits of harmonics*, Power Engineering Society Summer Meeting, 2001, IEEE, Volume: 2,15-19 July Pages:809 - 812 vol.2
- [7] IEC 1000-3-6 *Assessment of emission limits for distorting loads in MV and HV power systems-1996*

- [8] Wilsun Xu, *Application of steady state harmonic distortion limits to the time-varying measured harmonic distortions*, Power Engineering Society Meeting 2002 IEEE, Vol. 2, pp. 995-997
- [9] Probabilistic Aspect Task Force of the Harmonics Working Group Subcommittee, *Time-varying harmonics: Part I Characterizing measured data*, IEEE Transactions on Power delivery, Vol. 13, No .3, July 1998
- [10] Cavallini A., Montanari G.C., *A deterministic stochastic framework for power system harmonics modelling*, IEEE Transactions on Power Systems, Vol.12, No.1, February 1997
- [11] Stanković A.M., Marengo E.A., *A Dynamical Characterization of Power System Harmonics Using Markov Chains*, IEEE Transactions on Power Systems, 13(2), May 1998, pp. 442-448.
- [12] Anderson T.W., Goodman L.A., *Statistical inference about Markov chains*, Annals of Mathematical Statistics, Vol. 28, No. 1, March 1957, pp. 89-110
- [13] Ignatova V, Styczynski Z., Granjon P., Bacha.S *Statistical matrix representation of time-varying harmonics. Reconstruction and prediction applications*, PM PMAPS conference 2006
- [14] Dangelmayr G., Gadaleta S., Hundley D., Kirby M.: *Time series prediction by estimating Markov probabilities through topology preserving maps*, Proc. SPIE Vol. 3812, Applications and Science of Neural Networks, Fuzzy Systems, and Evolutionary Computation II. Edited by B. Bosacchi, D. B. Fogel and J.C. Bezdek. Pp. 86-93, 1999