



HAL
open science

Restoration of voice timbre in telephone networks, based on both voice and lines properties

Aline Neves, Gaël Mahé, Mamadou Mboup

► **To cite this version:**

Aline Neves, Gaël Mahé, Mamadou Mboup. Restoration of voice timbre in telephone networks, based on both voice and lines properties. Sep 2004, pp 1943-1946. <hal-00113826>

HAL Id: hal-00113826

<https://hal.science/hal-00113826v1>

Submitted on 14 Nov 2006

HAL is a multi-disciplinary open access archive for the deposit and dissemination of scientific research documents, whether they are published or not. The documents may come from teaching and research institutions in France or abroad, or from public or private research centers.

L'archive ouverte pluridisciplinaire **HAL**, est destinée au dépôt et à la diffusion de documents scientifiques de niveau recherche, publiés ou non, émanant des établissements d'enseignement et de recherche français ou étrangers, des laboratoires publics ou privés.



HAL Authorization

RESTORATION OF THE VOICE TIMBRE IN TELEPHONE NETWORKS BASED ON BOTH VOICE AND LINE PROPERTIES

A. Neves, G. Mahé and M. Mboup

Université René Descartes- Paris V, 45 rue des Saints-Pères 75270 Paris Cedex 06, France
 phone: +33 1 44 55 37 53, fax: +33 1 44 55 35 35, email: {aline.neves,gael.mahe,mboup}@math-info.univ-paris5.fr
 web: www.math-info.univ-paris5.fr/crip5/spir.php

ABSTRACT

The voice timbre suffers from different forms of distortions in a telephone link. In this paper, we propose a new blind equalizer for correcting these distortions, based on the combination of two different methods. The first one is a blind equalization method consisting in matching the long term spectrum of the processed signal to a reference spectrum, while the second one is a precompensation method, based on the physical characteristics of transmission lines. The new method is compared to the first one, showing a significant gain in performance.

1. INTRODUCTION

As we want to correct voice timbre distortions, we first define the timbre as the subjectively significant long term spectral characteristics of the voice of a given speaker. In the analog part of the PSTN (Public Switched Telephone Network) telephone link, as schematized in figure 1, the voice timbre suffers from two kinds of distortions.

The first one is the band-pass filtering (300-3400 Hz) at the end-points of the customer line (telephone terminal and line connections to the local exchange) in the transmission and reception paths. For the PSTN, this filtering is described on the average by the *modified Intermediate Reference System* (IRS) [1]. The frequency responses and masks of the sending and receiving parts of the modified IRS, respectively called sending and receiving systems, are defined in [1].

The second distortion is due to the customer's analog line, equivalent to a smooth low-pass filter. Its frequency response becomes steeper as the length of the line increases.

A blind spectral equalizer, placed in the digital part of the network (see Figure 1), was proposed in [2] to compensate for these distortions and restore a timbre as close as possible to that of the original speaker voice. In this paper, we propose to enhance the performance of this equalizer by combining it with another method, proposed in [3]. This method was firstly developed to precompensate a transmission line based on its physical parameters, which are not taken into account in the first method. However, it needs the knowledge of the length of the line, which is generally not known.

We will review the blind spectral equalizer proposed by [2] in Section 2 and the precompensation method proposed by [3] in Section 3. Section 4 presents the new method, combining [2] and [3], which simulation results are shown in Section 5.

2. BLIND SPECTRAL EQUALIZATION

In [2], the authors treated the problem of correcting the voice timbre using an equalizer composed of two filters. The first

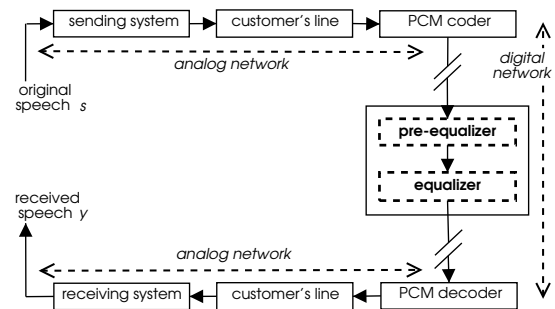

Figure 1: Telephone link with equalizer.

one is a fixed filter, called *pre-equalizer*, which frequency response is the inverse of the global response of the average analog channel in the band $[F_c - 3150 \text{ Hz}]$. The lower cutoff frequency F_c is fixed in order to avoid amplification of components with low signal to noise ratio (SNR). The average analog channel is defined as the combination of average customer analog lines with sending and receiving systems having frequency responses according to the nominal response of the modified IRS.

This filter is completed by an *adapted equalizer*, in order to adapt the global correction of the equalizer to various conditions of transmission. The frequency response of the second filter is computed as follows. Denoting G the frequency response of the analog channel, $|S(f)|^2$ the short-term power spectral density (PSD) of the original signal s and $|Y(f)|^2$ the short-term PSD of the received signal y , we have:

$$|Y(f)|^2 = |G(f)|^2 |S(f)|^2 \quad (1)$$

If we assume the channel to be time-invariant, the time-averages of $|Y(f)|^2$ and $|S(f)|^2$ are related by:

$$\overline{|Y(f)|^2} = |G(f)|^2 \overline{|S(f)|^2} \quad (2)$$

The frequency response of the adapted equalizer is therefore defined as:

$$|EQ(f)| = \frac{1}{|G(f)|} = \sqrt{\frac{\gamma_s(f)}{\gamma_r(f)}} \quad (3)$$

where γ denotes the *long-term spectrum* of a signal, defined as the time average of the short term spectrum.

Since the long term spectrum of the original voice $\gamma_s(f)$ is unknown, it is approximated in [2] by the average spectrum of speech defined in [4], called reference spectrum and denoted by $\gamma_{ref}(f)$. Moreover, since the equalizer is placed

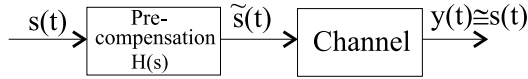

Figure 2: Precompensation system model

in the digital part of the network, $\gamma_s(f)$ is not directly available and therefore it must be derived from the input of the equalizer, u , using:

$$\gamma_s(f) = |L_{RX}(f)|^2 |S_{RX}(f)|^2 \gamma_u(f) \quad (4)$$

where L_{RX} is the frequency response of the receiving line and S_{RX} is the frequency response of the receiving system.

The frequency response of the adapted equalizer is then:

$$|EQ(f)| = \frac{1}{|L_{RX}(f)| |S_{RX}(f)|} \sqrt{\frac{\gamma_{ref}(f)}{\gamma_u(f)}} \quad (5)$$

Only the band $F_c - 3150 \text{ Hz}$ is equalized; the values of $|EQ|$ out of this band are therefore replaced by a linear extrapolation of $|EQ|_{[F_c-3150 \text{ Hz}]}$, before deriving the impulse response of the equalizer from $|EQ|$ by an IFFT.

Because of the roughness of the approximation $\gamma_s(f) = \gamma_{ref}(f)$, only the global shape of this frequency response is relevant. That is why the frequency response $|EQ|$ must be smoothed. This smoothing is achieved by a narrow Hamming-windowing of the impulse response [2]. In the sequel, the equalizer shown here will be referenced as BSE-W, *i.e.* blind spectral equalizer smoothed by a windowing of the impulse response. This smoothing is however not ideal, since it leads to irrelevant oscillations in the global frequency response of the equalizer link.

3. PRECOMPENSATION BASED ON THE CUSTOMER'S LINE MODEL

The customer's line, shown in Figure 1, can be modelled as a transmission line using the following system of equations:

$$\begin{aligned} L \frac{\partial i}{\partial t} &= -Ri - \frac{\partial v}{\partial x} \\ C \frac{\partial v}{\partial t} &= -\frac{\partial i}{\partial x} - Gv \end{aligned} \quad (6)$$

where $v(x, t)$ and $i(x, t)$ are, respectively, the tension and the current at a distance x from the origin, at a time t . The line parameters are R , the resistance, L , the inductance, C , the capacity and G the conductance per unit length. The transmitted signal, *i.e.*, the signal at the beginning of the line is $s(t) = v(0, t)$ and the signal at the end of the line is $y(t) = v(\ell, t)$ where ℓ is the length of the line.

In [3], the authors treated the problem of precompensating the signal transmitted through a transmission line channel modelled as in (6). The goal is to anticipate the channel distortions in order to obtain a channel output signal, $y(t)$, as close as possible to the original signal $s(t)$, as shown in Figure 2. In [3], the transfer function of the precompensation filter, $H(f)$, is found by inverting the channel, *i.e.*, by finding the transmission line input as a function of its output. Considering (6) with boundary conditions $v(0, t) = s(t)$ and $y(t) = v(\ell, t) = Zi(\ell, t)$, and with zero initial conditions,

$v(x, 0) = \frac{\partial v}{\partial t}(x, 0) = 0$, [3] finds the following transfer function for the inverse channel:

$$H(f) = \cosh(\ell\beta) + \frac{R + i\omega L \sinh(\ell\beta)}{Z\beta} \quad (7)$$

where $\beta(\omega) = \sqrt{-LC\omega^2 + i\omega RC}$ and $\omega = 2\pi f$.

$H(f)$ can be used in our context, presented in Section 1, as a post-processor instead of a pre-processor, equalizing the transmitter customer's line. However, it needs the length of the line, a parameter that is generally not known.

4. PROPOSED METHOD

We consider here the telephone link shown in Figure 1. The frequency responses of the receiving system and the reception line (S_{RX} and L_{RX} respectively) are assumed to be known, as in section 2, and, in addition, so are the sending system and the parameters R , L , C and G of the line. The pre-equalizer compensates the distortions caused by the sending and receiving systems and the reception line.

Under these assumptions, the frequency response of the adapted equalizer is the inverse of the transmission line response and is given by the precompensation method (7). The only problem is that (7) needs the length of the line, a parameter that is not known. A solution is to look for the length ℓ for which $H(f)$ is the best possible approximation of the frequency response of the adaptive equalizer, EQ , computed as in Section 2, in the frequency range of interest $F_c - 3150 \text{ Hz}$. For this purpose we compare H and EQ in the cepstral domain, the cepstrum of a filter of frequency response H being defined by:

$$C^H = IDFT(\ln(|H|)) \quad (8)$$

We define the cost function to be minimized as the distance between H and EQ in the space of the ten first cepstral coefficients:

$$J = \sum_{k=1}^{10} (C_k^{EQ} - C_k^H)^2 \quad (9)$$

where C_k^{EQ} is the k th cepstral coefficient related to EQ and C_k^H is the k th cepstral coefficient related to H . The interest in using this space of comparison instead of the spectral domain lies in:

- the fact that it allows the comparison between the shapes of the frequency responses without considering their level, simply by excluding the cepstral coefficient of order zero;
- the possibility of controlling the spectral resolution of the comparison, since it depends on the number of cepstral coefficients involved in the comparison.

A gradient descent algorithm was implemented using the following recursion equation:

$$\ell_{n+1} = \ell_n - \mu \nabla_{\ell} J(n) \quad (10)$$

where μ is the step constant and

$$\nabla_{\ell} J(n) = - \sum_{k=1}^{11} (C_k^{EQ} - C_k^H(\ell_n)) \frac{\partial C_k^H}{\partial \ell}(\ell_n) \quad (11)$$

The differentiation of C^H with respect to ℓ gives:

$$\frac{\partial C^H}{\partial \ell} = IDFT \left(\frac{1}{\sqrt{|H|}} \left(H^* \frac{\partial H}{\partial \ell} + H \frac{\partial H^*}{\partial \ell} \right) \right) \quad (12)$$

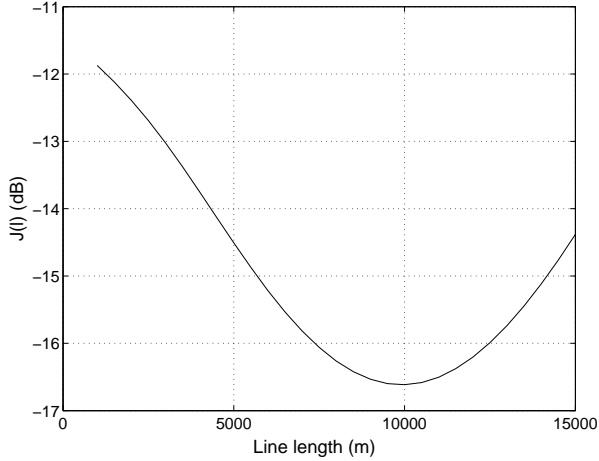

Figure 3: Cost function $J(l)$

with

$$\frac{\partial H}{\partial \ell} = \beta \sinh(\beta \ell) + \frac{R + i\omega L}{Z} \cosh(\beta \ell) \quad (13)$$

Figure 3 shows a typical example of the cost function J as a function of ℓ . As we can see, the curve has only one minimum, even though the presence of local minima can not be completely discarded due to the random nature of EQ . For this simulation, the customer's line had a 10 km length.

We call this new method blind spectral equalization based on physical parameters (BSE-P).

5. SIMULATION AND RESULTS

We have compared the performances of the BSE-W method proposed in [2] with the BSE-P method discussed in Section 4. The analog part of the simulated telephone link is composed of a long transmission line, an average reception line and sending and receiving systems having frequency responses according to the nominal response of the modified IRS [1]. A typical telephone line has: $R=168 \text{ m}\Omega$, $L=0.7 \text{ mH}$, $C=50 \text{ pF}$ and $G=0$ [5]. The impedance at the end of this line, denoted Z , is the input impedance of the hybrid device (2 wires/4 wires connection). Typical values are a 600Ω resistive impedance or a 270Ω resistance in series with a cell of 750Ω in parallel with a 150 nF capacitor (new devices) [5].

Simulations were done using a set of 34 different speakers uttering a text of approximately 20s of voice activity. The signal was divided in slots of 256 samples, with 50% of overlapping. F_c was set to 200 Hz. The average line length was considered equal to 2km while the customer's line is 10 km long. Its parameters values R , L , C and G are given above and Z was considered complex.

For the BSE-W, the adaptive equalizer filter had 15 coefficients and was computed as in Section 2. For the BSE-P, the algorithm given by (10) was initialized with $\ell(0) = 2 \text{ km}$, given that this is the average length value of a customer line, and the step constant, μ , was set equal to $5 \cdot 10^3$.

We have used two forms of comparison. In the first one, we measured the performances by means of the cepstral er-

ror, CE . For each m -th signal slot, CE is defined as [6]:

$$CE^m = \sqrt{\sum_{k=1}^{20} (C_k^i(m) - C_k^e(m))^2} \quad (14)$$

where C_k^i is the k th cepstral coefficient of the ideal equalizer (inversion of the line without errors) and C_k^e is the k th cepstral coefficient of the equalizer being tested. Figure 4 shows the comparison between the mean cepstral errors (MCE), computed as a time average of the cepstral errors, for the 34 speakers tested. We can observe that, for the large majority of the cases tested, the BSE-P achieves a smaller MCE. However, there are cases where the BSE-W has a better performance. Note that the BSE-W tries to recover the voice timbre using a ruder approach, that is afterwards refined by the BSE-P method. Thus, if this first approach, given by EQ , is satisfactory, the BSE-P will enhance the performance of the system, giving a better result. However, if it is not satisfactory, the BSE-P will try to refine something that is already bad, leading to a worse result.

The algorithm used, given by (10), considered 10 cepstral coefficients. Simulations have shown that increasing this value does not result in a better performance.

For an easier visualization of the difference between the two methods, we also compared the systems global frequency responses. Figure 5 shows an example of the result obtained (speaker number 13). We can clearly see that the BSE-P response is closest to the ideal response than the BSE-W method.

Finally, Figure 6 shows the equalizers frequency responses, comparing $|EQ|$, given by (5), the smoothing obtained using the Hamming window and the result obtained using BSE-P. We can see that this last one almost superposes the ideal equalizer response.

Since our goal is to restore the voice timbre, the interest of this cepstral error reduction lies in its subjective impact. Relationships between cepstral error and timbre restoration were established in [6] based on formal subjective tests. Since these relationships were established in the same context and for similar cepstral and spectral distortions, we can use them to evaluate the perceptual meaning of these results. According to [6], the BSE-P leads to a significant improvement of the timbre restoration for at least speakers 5 and 29 (Figure 4).

6. DISCUSSION

One could object to this method that it needs the knowledge of too many parts of the link: sending and receiving systems and the receiver line. This strong assumption was made only to stay in the frame of [2], in order to evaluate the gain of our new method. In practice, few elements of the link have to be known.

Let us consider the link schematized in Figure 7, where the voice timbre of speaker B is to be restored for speaker A in reception. The transmission path from B to the 2 wires / 4 wires connection can be estimated using the BSE-W method. Then, knowing the frequency response of the sending system of A, we can estimate the length of the analog line of A using the BSE-P method. At last, knowing the frequency response of the receiving system of A, we deduce the frequency response of the complete analog channel from B to A. Thus,

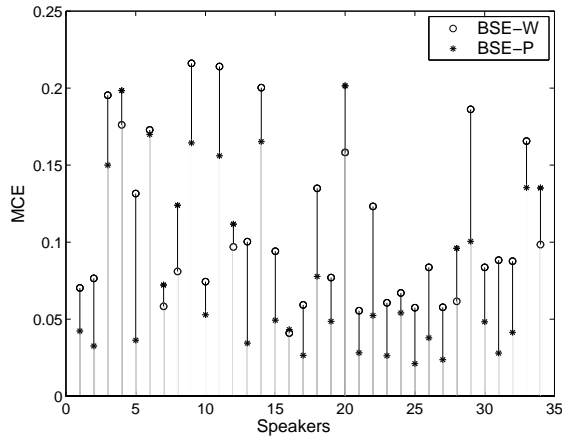

Figure 4: Comparison between the cepstrum errors of the two methods

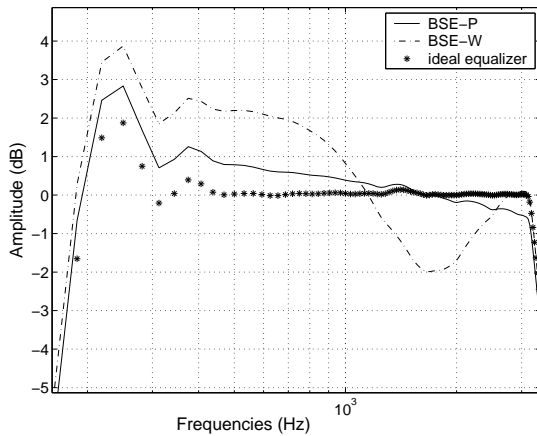

Figure 5: Comparison between the frequency response of the global systems

we only need to know the characteristics of A's terminal to offer A a restored timbre of B.

7. CONCLUSION

In this paper we developed a new blind equalization algorithm for correcting the voice timbre distortions in a telephone link. To do so, we based ourselves on the precompensation method proposed by [3]. Since this method needs the knowledge of the line length, we developed a blind way to find this information using the blind spectral equalizer proposed in [2] and a cost function which minimization leads to a good estimation of the line length.

The comparison of this new method with the one proposed in [2] showed a significant gain in performance and substantial improvement in the voice timbre restoration for the large majority of the cases tested.

8. ACKNOWLEDGEMENTS

We thank gratefully Vincent Barriac and Joseph Belleil (France Telecom R&D) for their helpful information on networks and devices.

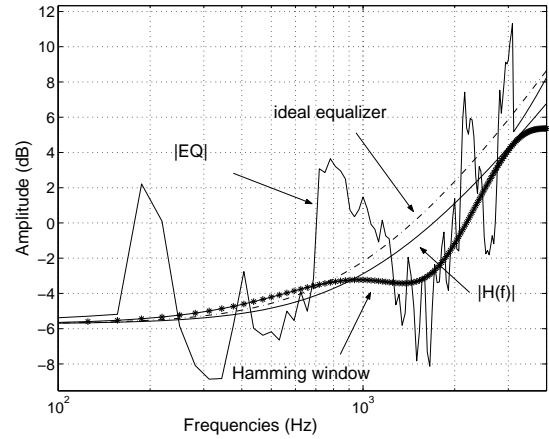

Figure 6: EQ(f) before smoothing, H(f) with ℓ obtained by (10) and EQ(f) smoothed by the Hamming windowing

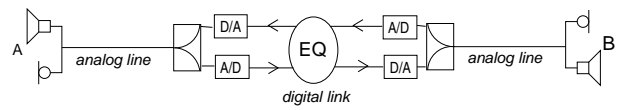

Figure 7: Link between two users

REFERENCES

- [1] ITU-T Recommendation P.830, *Subjective performance assessment of telephone-band and wideband digital codecs*, annex D, 1996.
- [2] G. Mahé and A. Gilloire, "Correction of the voice timbre distortions on telephone network," in *Proc. Eurospeech*, pp. 1867–1870, 2001.
- [3] M. Fliess, P. Martin, N. Petit, and P. Rouchon, "Commande de l'équation des télégraphistes et restauration active d'un signal," *Traitement du Signal*, vol. 15, no. 6, pp. 619–625, 1998.
- [4] ITU-T Recommendation P.50, *Artificial voices*, 1993.
- [5] ITU-T Recommendation Q.552, *Commutation and Signaling*, 2001.
- [6] G. Mahé, *Correction Centralisée des Distorsions Spectrales de la Parole sur les Réseaux Téléphoniques*, Ph.D. thesis, Université de Rennes 1, Rennes, France, 2002.