



HAL
open science

Three-dimensional yield strength properties of jointed rock mass as a homogenized medium

Arnaud Bekaert, Samir Maghous

► **To cite this version:**

Arnaud Bekaert, Samir Maghous. Three-dimensional yield strength properties of jointed rock mass as a homogenized medium. *Mechanics of Cohesive-frictional Materials*, 1996, 1 (1), pp.1-24. 10.1002/(SICI)1099-1484(199601)1:13.O.CO;2-O . hal-00111509

HAL Id: hal-00111509

<https://hal.science/hal-00111509v1>

Submitted on 12 Apr 2024

HAL is a multi-disciplinary open access archive for the deposit and dissemination of scientific research documents, whether they are published or not. The documents may come from teaching and research institutions in France or abroad, or from public or private research centers.

L'archive ouverte pluridisciplinaire **HAL**, est destinée au dépôt et à la diffusion de documents scientifiques de niveau recherche, publiés ou non, émanant des établissements d'enseignement et de recherche français ou étrangers, des laboratoires publics ou privés.



Distributed under a Creative Commons Attribution - NonCommercial 4.0 International License

Three-dimensional yield strength properties of jointed rock mass as a homogenized medium

A. Bekaert* and S. Maghous

*Laboratoire de Mécanique des Solides (URA 317 CNRS), ENPC-CERCSO, Central 2, La Courtine,
93167 Noisy-Le-Grand cedex, France*

SUMMARY

A comprehensive three-dimensional formulation for the strength criterion of regular jointed rocks is derived in this paper. The approach is based upon the implementation of the homogenization method of periodic media within the framework of the yield design theory. A rigorous explicit expression of the macroscopic criterion is given as a function of the strength properties of the intact rock and of the joints modelled as interfaces. Attention is focused on the particular case of an infinitely resistance intact rock. It is shown in particular how the relevant velocity jumps for the homogenized medium can be characterized from the introduction of the set of admissible stress vectors acting upon an elementary surface. The results make it possible to perform the static and kinematic approaches in order to address the stability analysis of rock masses cut by sets of regular joints, even for the three-dimensional geometries.

KEY WORDS: jointed rocks; strength criterion; homogenization method; yield design; anisotropy

1. INTRODUCTION

A rock mass seldom appears as a homogeneous isotropic material, since it is always broken up by several joints, faults or bedding planes. Numerous laboratory and *in situ* experiments give evidence of the anisotropic behaviour of a jointed rock mass (see, for example, References 1–4). And generally the presence of joints drastically complicates the evaluation of the strength criterion for the homogenized medium. The first difficulty is to obtain representative strength criteria for the joints and the intact rock mass separately, the second is to compute these criteria altogether in order to represent the strength properties for the considered material.

To analyse the stability of a structure built into a jointed rock mass medium, some authors do not focus their research on the determination of a macroscopic criterion. They consider the intact rock mass as infinitely resistant, in such a way that the joints are the only weakness zones into the body of the material (References 5–7 for example), so that a combination of these joints permits to identify the possible failure patterns of rock blocks. One of the most important numerical techniques that should be mentioned is the so called ‘distinct element method’ (essentially due to Cundall and co-authors, (see References 8–11). This numerical method, making use of an explicit finite difference scheme, considers the rock blocks as elastic or elastic-plastic bodies in motion, interacting one with another.

The approach developed in the present paper is to be compared with another category of works taking account of both rock and joint criteria (12–16). The numerous experiments that have been conducted, enabled Hoek¹⁷ to establish that for heavily jointed rock as for intact rock mass, the

* Also at: Bouygues-TP, Challenger, 1 av. E. Freyssinet, 78061 St-Quentin-Yvelines, France

strength criterion could reasonably be considered as homogeneous and isotropic. In the intermediate cases the (analytical) models fall within two categories.

(i) *Discontinuous models*, which rely on the hypothesis that the joint sets could be examined separately within the rock mass and then the associated criteria superposed.^{16,18,19}

(ii) *Continuous models*, where the jointed rock is considered as continuous at the sample scale. The strength criterion can either be a Mohr–Coulomb criterion with variable parameters with respect to the inclination of the joints^{18,20} or expressed in a tensorial form with a finite number of parameters to be determined by a curve fitting procedure on experimental data.^{21–23}

Nevertheless, none of these attempts have lead in a general case to a rigorous expression of a macroscopic homogeneous criterion for the jointed rock mass as a result of the combination of the joints and the rock mass own criteria. The aim of this contribution is to derive a formulation of this criterion within the framework of the yield design homogenization theory.^{24,25} It should be mentioned that the concept of equivalent medium for modelling heterogeneous rock masses has already been introduced to describe:

- (a) the behaviour of fractured rock masses (see, for example, Reference 26), where the intact rock, containing up to three sets of orthogonal joints, is assumed to be linearly elastic. The joints are modelled in a non-linear inelastic fashion in compression and tension, and in a linear elastic fashion in shear.
- (b) the macroscopic elastic behaviour of a stratified rock mass (see, for example, Reference 27).
- (c) the macroscopic strength domain of stratified intact rock mass modelled as a multi-layered medium.²⁸

It should be kept in mind that the primary purpose of deriving such a homogenized criterion for the jointed rock mass is to be able to analyse the stability of structures such as sketched in Figure 1(a) (slopes, excavations, openings, etc.). Indeed, attempts to design such structures by considering the rock blocks and the joints separately are ultimately doomed to failure, since the numerical treatment of the problem is becoming rapidly untractable as the number of block elements increases. Fortunately in such a case, provided that some particular conditions that will be further stated be satisfied, the initial problem can be replaced by the study of a structure made of homogeneous, but obviously anisotropic, medium (Figure 1(b)). Therefore, it is essential to dispose of closed form analytical expressions for the strength criterion of the homogenized medium, thus making it possible to perform the stability analysis of the homogenized structure in a much more efficient way than through a direct approach. It is to be emphasized that one of the distinctive features of the approach developed hereafter consists in treating the joints as two-dimensional interfaces.

2. BASICS OF THE YIELD DESIGN HOMOGENIZATION METHOD

The heterogeneous body under consideration occupies a domain Ω and exhibits a periodic structure so that it is possible to extract a ‘unit cell’, denoted by \mathcal{A} , which represents the smallest elementary volume necessary to describe the structure completely (Figure 2).

As first shown by Suquet²⁹ and later by de Buhan,³⁰ the determination of the macroscopic strength condition of the above periodic heterogeneous material reduces to solving a yield design boundary value problem defined over the unit cell.

Static definition of the macroscopic strength criterion

Denoting by $G(\underline{x})$ the strength convex of the constituent material at every point \underline{x} of \mathcal{A} , the macroscopic strength domain G^{hom} of the periodic medium is defined as the set of macroscopic states of stress $\underline{\Sigma}$, such that there exists a stress field $\underline{\sigma}$ defined over \mathcal{A} and satisfying

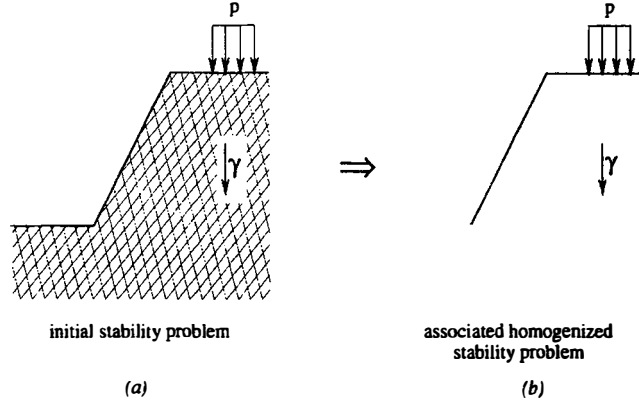

Figure 1. Initial stability problem and associated homogenized stability problem

- (a) $\underline{\underline{\Sigma}} = \langle \underline{\underline{\sigma}} \rangle$, where $\langle \cdot \rangle = \frac{1}{|\mathcal{A}|} \int_{\mathcal{A}} \cdot dv$ (volume average over \mathcal{A}),
- (b) $\text{div } \underline{\underline{\sigma}}(\underline{x}) = \underline{0} \quad \forall \underline{x} \in \mathcal{A}$,
- (c) $\underline{\underline{\sigma}} \cdot \underline{n}$ antiperiodic, i.e. taking opposite values on opposite sides of \mathcal{A} , where \underline{n} is the outer unit normal,
- (d) $\underline{\underline{\sigma}}(\underline{x}) \in G(\underline{x}) \quad \forall \underline{x} \in \mathcal{A}$.

Conditions (a) to (c) express equilibrium, while condition (d) represents the strength requirement. This may be summarized by

$$G^{hom} = \{ \underline{\underline{\Sigma}} = \langle \underline{\underline{\sigma}} \mid \underline{\underline{\sigma}} \cdot \underline{n} \text{ antiperiodic, } \text{div } \underline{\underline{\sigma}} = \underline{0}, \underline{\underline{\sigma}}(\underline{x}) \in G(\underline{x}) \quad \forall \underline{x} \in \mathcal{A} \}. \quad (1)$$

The convexity of $G(\underline{x})$ whatever \underline{x} implies the same property for the macroscopic strength domain G^{hom} .

Kinematic definition of G^{hom}

Equation (1) represents the *static definition* of G^{hom} and its 'dual' *kinematic definition* may be expressed through the support function of G^{hom} defined as:³¹

$$\pi^{hom}(\underline{D}) = \sup \{ \underline{\underline{\Sigma}} : \underline{D}; \underline{\underline{\Sigma}} \in G^{hom} \}, \quad (2)$$

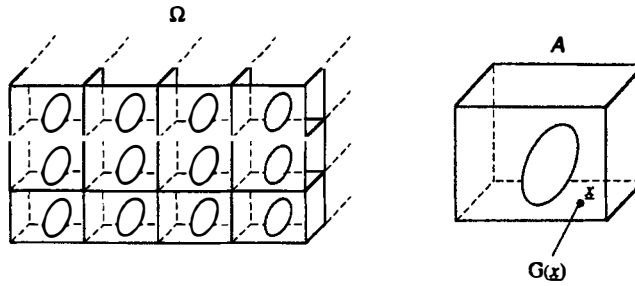

Figure 2. Periodic heterogeneous material and associated unit cell

where $\underline{\underline{D}}$ denotes any symmetric second order tensor. Let us introduce now, for a given $\underline{\underline{D}}$, the set of virtual velocity fields \underline{v} kinematically admissible with $\underline{\underline{D}}$. That is the set of \underline{v} satisfying the two conditions:

(i)

$$\underline{\underline{D}} = \langle \underline{d} \rangle = \frac{1}{2|\mathcal{A}|} \int_{\partial\mathcal{A}} (\underline{v} \otimes \underline{n} + \underline{n} \otimes \underline{v}) dS,$$

\underline{d} being the strain rate field associated with \underline{v} .

(ii) $\underline{v} - \underline{F} \cdot \underline{x}$ is periodic (i.e. taking the same value on opposite sides), where

$$\underline{F} = \langle \text{grad } \underline{v} \rangle = \frac{1}{|\mathcal{A}|} \int_{\mathcal{A}} \text{grad } \underline{v} dV = \frac{1}{|\mathcal{A}|} \int_{\partial\mathcal{A}} \underline{v} \otimes \underline{n} dS$$

(note that $\underline{\underline{D}}$ represents the symmetric part of \underline{F}).

It can be proved (see for example de Buhan³⁰) that the support function defined by (2) may be computed as

$$\pi^{hom}(\underline{\underline{D}}) = \min_{\underline{v}} \{ \langle \pi(\underline{d}) \rangle \}, \quad (3)$$

where $\pi(\cdot)$ denotes the support function of the convex domain $G(\underline{x})$, defined as

$$\pi(\underline{d}) = \sup \{ \underline{g} : \underline{d}; \underline{g} \in G(\underline{x}) \}. \quad (4)$$

This kinematic definition of G^{hom} can be geometrically interpreted in the six dimensional space of macroscopic stresses $\underline{\underline{\Sigma}}$ as follows. Equation (2) shows that, for a given $\underline{\underline{D}}$, $\pi^{hom}(\underline{\underline{D}})$ is proportional to the distance from the origin to the hyperplane tangent to the boundary surface of G^{hom} at the point(s) where the outward normal is parallel to $\underline{\underline{D}}$ (Figure 3). Furthermore, equation (3) shows that for any velocity field \underline{v} satisfying the above conditions, G^{hom} is included in the half space defined by

$$\underline{\underline{\Sigma}} : \underline{\underline{D}} - \langle \pi(\underline{d}) \rangle \leq 0. \quad (5)$$

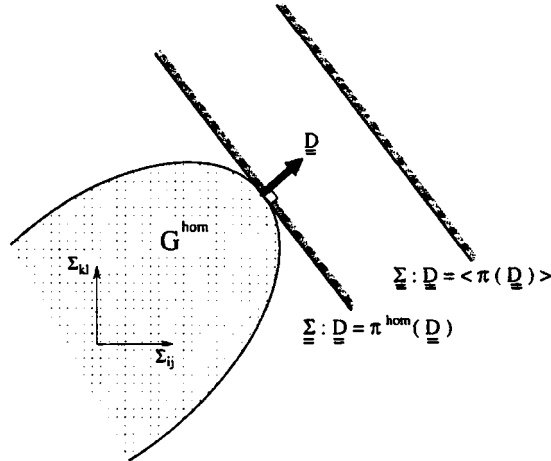

Figure 3. Geometrical interpretation of the kinematic definition of G^{hom}

G^{hom} may be defined as the convex envelope of tangent hyperplanes:

$$G^{hom} = \bigcap_{\underline{D}} \{ \underline{\Sigma} | \underline{\Sigma} : \underline{D} - \pi^{hom}(\underline{D}) \leq 0 \}. \quad (6)$$

3. MACROSCOPIC STRENGTH CRITERION FOR FRACTURED ROCKS

3.1. Geometrical assumptions

Consider a homogeneous rock mass medium comprising a periodic distribution of planar joints, such that the unit cell \mathcal{A} is a parallelepipedic volume containing p planar rock joints ($1 \leq p \leq 3$) (Figure 4). Each plane, denoted by P_i ($i = 1, p$), will be characterized by its unit normal \underline{n}_i and its surface S_i . By a suitable scale change, its measure can always be set equal to 1, so that in subsequent analysis $|\mathcal{A}| = 1$ will be assumed for simplicity.

The strength capacities of the constituents of this composite material are defined as follows.

The strength condition of the intact rock material, assumed to be homogeneous, is described by a fixed convex domain G^m (m for matrix) in the six-dimensional space of stresses:

$$G(x) = G^m, \forall \underline{x} \in \mathcal{A}. \quad (7)$$

The joints are modelled as interfaces. Their failure condition is taken into account by means of a convex domain of allowable stress vectors \underline{T} acting upon those interfaces at any point, namely:

$$\underline{T} = \underline{\sigma} \cdot \underline{n}_i \in \mathcal{G}_i, \forall \underline{x} \in P_i. \quad (8)$$

where $\mathcal{G}_i \subset \mathbb{R}^3$ denotes the strength convex related to the interface i ($1 \leq i \leq p$), and assumed to be independent of the point considered.

Note that \mathcal{G}_i may also be defined through its support function expressed by:

$$\pi(\underline{n}_i, [\underline{v}]) = \sup \{ \underline{T} \cdot [\underline{v}]; \underline{T} \in \mathcal{G}_i \}, \quad (9)$$

where $[\underline{v}]$ denotes the velocity jump across the interface i when following its normal \underline{n}_i .

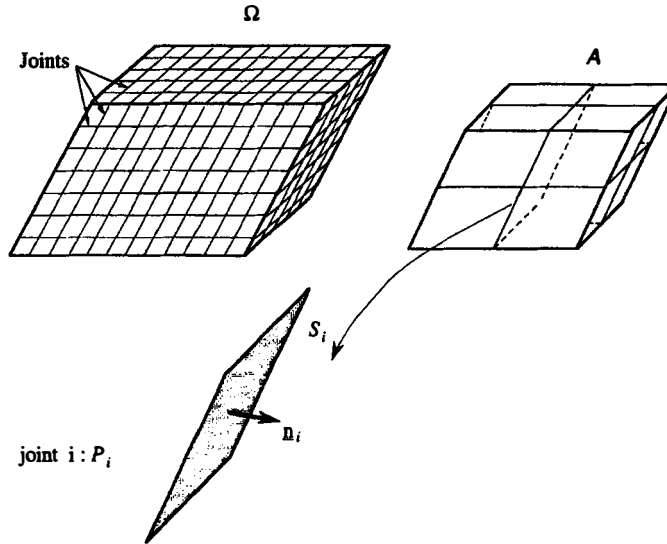

Figure 4. Rock jointed structure and associated unit cell

Remark. The definition of the macroscopic strength criterion, shows that only the strength domain of the matrix and joints are involved. No additional information regarding the constitutive behaviour of the composit components, such as the elastic stiffness characteristics, is required.

3.2. Static definition of G^{hom}

It results directly from the general definition given by (1):

$$\underline{\underline{\Sigma}} \in G^{hom} \Leftrightarrow \exists \underline{\underline{\sigma}} \in \mathcal{S} \begin{cases} \underline{\underline{\Sigma}} = \langle \underline{\underline{\sigma}} \rangle, \\ \underline{\underline{\sigma}}(\underline{x}) \in G^m, & \forall \underline{x} \in \mathcal{A}, \\ \underline{\underline{\sigma}}(\underline{x}) \cdot \underline{n}_i \in \mathcal{G}_i, & \forall \underline{x} \in \mathcal{P}_i, i = 1, p, \end{cases} \quad (10)$$

where \mathcal{S} denotes the set of stress fields $\underline{\underline{\sigma}}$ defined on \mathcal{A} and satisfying the equilibrium equations (i.e. $\text{div } \underline{\underline{\sigma}} = 0$, $\underline{\underline{\sigma}} \cdot \underline{n}$ antiperiodic).

Definition (10) may be equivalently expressed as

$$G^{hom} = G^m \cap G'_{int}, \quad (11)$$

where

$$G'_{int} = \{ \underline{\underline{\Sigma}} | \exists \underline{\underline{\sigma}} \in \mathcal{S}, \underline{\underline{\Sigma}} = \langle \underline{\underline{\sigma}} \rangle, \forall \underline{x} \in \mathcal{P}_i \underline{\underline{\sigma}}(\underline{x}) \cdot \underline{n}_i \in \mathcal{G}_i \text{ for } i = 1, p \}. \quad (12)$$

By introducing the set G_{int} , defined as

$$G_{int} = \{ \underline{\underline{\Sigma}} | \underline{\underline{\Sigma}} \cdot \underline{n}_i \in \mathcal{G}_i \forall i = 1, p \} = \bigcap_{i=1}^p \{ \underline{\underline{\Sigma}} | \underline{\underline{\Sigma}} \cdot \underline{n}_i \in \mathcal{G}_i \}, \quad (13)$$

the identity between G'_{int} and G_{int} can be established (see Appendix A), so that

$$G^{hom} = G^m \cap G_{int}. \quad (14)$$

Note that G_{int} is a convex domain of \mathbb{R}^6 whose elements are stress tensors that respect the strength criteria of all the joints without taking into account the characteristics of the matrix material.

Looking forward to implementing the kinematic approach over the homogenized structure by considering velocity discontinuities across surfaces, it is convenient to introduce the set $g^{hom}(\underline{N}) \subset \mathbb{R}^3$ of allowable stress vectors acting upon an elementary surface, of normal \underline{N} , of the homogenized material, defined by

$$g^{hom}(\underline{N}) = \{ \underline{T} | \exists \underline{\underline{\Sigma}} \in G^{hom} \underline{T} = \underline{\underline{\Sigma}} \cdot \underline{N} \}. \quad (15)$$

It is equivalent to determine G^{hom} or $\{g^{hom}(\underline{N}), \forall \underline{N}\}$, but the advantage of the latter is that it lends itself more easily to a graphic representation, since $g^{hom}(\underline{N})$ is a domain of \mathbb{R}^3 .

The dual definition of the above convex is expressed by introducing its support function, defined in the same way as (9) for \mathcal{G}_i

$$\pi^{hom}(\underline{N}, [\underline{v}]) = \sup \{ \underline{T} \cdot [\underline{v}]; \underline{T} \in g^{hom}(\underline{N}) \}, \quad (16)$$

which may be computed with the help of the support function of G^{hom} by

$$\pi^{hom}(\underline{N}, [\underline{v}]) = \pi^{hom}(\underline{D}) \text{ with } \underline{D} = [\underline{v}] \overset{\mathcal{S}}{\otimes} \underline{N}, \quad (17)$$

where $\overset{\mathcal{S}}{\otimes}$ denotes the 'symmetric part of tensional product' (i.e. $\underline{a} \overset{\mathcal{S}}{\otimes} \underline{b} = \frac{1}{2}(\underline{a} \otimes \underline{b} + \underline{b} \otimes \underline{a})$).

Remark. The previous domain may be expressed as

$$\mathbf{g}^{hom}(\underline{N}) = \{\underline{T} = \underline{\Sigma} \cdot \underline{N} | \underline{\Sigma} \in G^m, \underline{\Sigma} \cdot \underline{n}_i \in \mathcal{G}_i \quad \forall i = 1, p\}, \quad (18)$$

which is different from the set defined by

$$\mathbf{g}(\underline{N}) = \bigcap_{i=1}^p \{\underline{T} = \underline{\Sigma} \cdot \underline{N} | \underline{\Sigma} \in G^m, \underline{\Sigma} \cdot \underline{n}_i \in \mathcal{G}_i\}, \quad (19)$$

corresponding to the intersection of the strength domains relative to a rock mass medium with a single network of joints perpendicular to the direction \underline{n}_i .

Comparing definitions (18) and (19), it comes out immediately that

$$\mathbf{g}^{hom}(\underline{N}) \subset \mathbf{g}(\underline{N}), \quad (20)$$

which does not reduce to equality in the general case. This result shows that for the determination of $\mathbf{g}^{hom}(\underline{N})$ it is not equivalent to treat the problem of p planar networks of joints altogether and to intersect the domains obtained by taking each network separately. This second approach would only yield upper bound estimates for $\mathbf{g}^{hom}(\underline{N})$.

4. APPLICATION TO JOINTED ROCKS WITH INFINITELY RESISTENT MATRIX

We will consider from now on the particular, but quite important case of a jointed rock mass whose constituent matrix material is assumed to be infinitely strong with respect to the joints. That is

$$G^m = \mathbb{R}^6. \quad (21)$$

In other terms, this assumption means that failure of the jointed rock mass as a whole is only due to that of the joints. Then definition (14) of G^{hom} becomes

$$G^{hom} = G_{int} = \{\underline{\Sigma} | \underline{\Sigma} \cdot \underline{n}_i \in \mathcal{G}_i \quad \forall i = 1, p\} = \bigcap_{i=1}^p \{\underline{\Sigma} | \underline{\Sigma} \cdot \underline{n}_i \in \mathcal{G}_i\} \quad (22)$$

and (15) reduces, for any \underline{N} , to

$$\mathbf{g}^{hom}(\underline{N}) = \{\underline{T} = \underline{\Sigma} \cdot \underline{N} | \underline{\Sigma} \cdot \underline{n}_i \in \mathcal{G}_i \quad \forall i = 1, p\}. \quad (23)$$

Moreover, the strength capacities of the joints will be described by means of a Mohr–Coulomb's strength condition:

$$\forall i = 1, p, \underline{T} \in \mathcal{G}_i \Leftrightarrow |\tau| \leq c - \sigma \tan \varphi, \quad (24)$$

where $\sigma = \underline{T} \cdot \underline{n}_i$ and $\tau = |\underline{T} - \sigma \underline{n}_i|$ are the normal and shear components of \underline{T} respectively. c and φ denote the cohesion and the internal frictional angle. The corresponding π -function writes:^{31,32}

$$\pi(\underline{n}_i, |\underline{v}|) = \begin{cases} \frac{c}{\tan \varphi} |\underline{v}| \cdot \underline{n}_i & \text{if } |\underline{v}| \cdot \underline{n}_i \geq ||\underline{v}|| \sin \varphi, \\ +\infty, & \text{otherwise.} \end{cases} \quad (25)$$

4.1. Kinematics of the unit cell

The infinite strength assumption for the matrix material implies that the relevant velocity fields to be considered in the yield design kinematic approach of G^{hom} , are significantly simplified. Indeed, their associated strain rate fields must be everywhere equal to zero, except possibly on interfaces P_i . In other terms, it means that a necessary condition for a velocity field \underline{v} defined on \mathcal{A} to be relevant is that the

restriction of \underline{v} to each of the 2^p blocks making up the unit cell and separated by the joints, corresponds to a rigid body motion.

Consequently, the velocity fields to be explored are necessarily expressed as a sum of the p velocity fields \underline{v}_i defined as follows:

$$\underline{v}_i(\underline{x}) = \begin{cases} \underline{0} & \text{if } \underline{x} \in \mathcal{A}_i^-, \\ \underline{\alpha}_i + \underline{\omega}_i \wedge \underline{x} & \text{if } \underline{x} \in \mathcal{A}_i^+, \end{cases} \quad (26)$$

where $\underline{\alpha}_i$ and $\underline{\omega}_i$ denote the translation and rotation vectors of block \mathcal{A}_i^+ separated from block \mathcal{A}_i^- by the interface P_i (Figure 5).

The above velocity field is discontinuous when crossing P_i following its normal \underline{n}_i :

$$\forall \underline{x} \in P_i \quad [\underline{v}_i] = \underline{\alpha}_i + \underline{\omega}_i \wedge \underline{x} \quad (27)$$

and the associated tensor $\underline{\underline{F}}_i$ is given by

$$\underline{\underline{F}}_i = \langle \text{grad } \underline{v}_i \rangle = \int_{P_i} [\underline{v}_i] \otimes \underline{n}_i dS. \quad (28)$$

It can be established (see Appendix B) that the periodicity of $\underline{u} = \underline{v}_i - \underline{\underline{F}}_i \cdot \underline{x}$ is ensured if, and only if,

$$\underline{\omega}_i = \underline{0}, \quad (29)$$

so that (26) reduces to

$$\underline{v}_i(\underline{x}) = \begin{cases} \underline{0} & \text{if } \underline{x} \in \mathcal{A}_i^-, \\ \underline{\alpha}_i & \text{if } \underline{x} \in \mathcal{A}_i^+ \end{cases} \quad (30)$$

and (28) becomes

$$\underline{\underline{F}}_i = S_i(\underline{\alpha}_i \otimes \underline{n}_i). \quad (31)$$

The velocity fields to be explored in the kinematic approach are thus completely defined by p parameters, namely the $\underline{\alpha}_i$ which define the elementaries \underline{v}_i given through (26). More precisely, a necessary condition for a velocity \underline{v} defined on the unit cell to be relevant is

$$\exists \underline{v}_i (i = 1, p) \text{ of the form (30) such that } \underline{v} = \sum_{i=1}^p \underline{v}_i \quad (32)$$

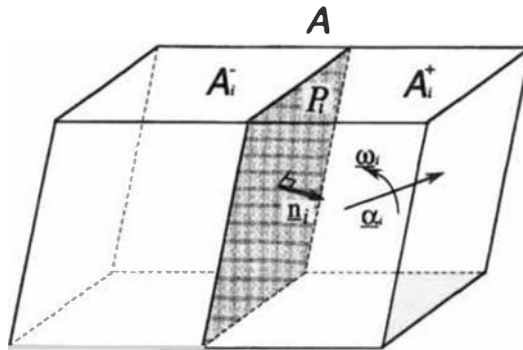

Figure 5. Elementary piecewise rigid block velocity field of the unit cell

and the corresponding macroscopic strain rate is then given by

$$\underline{\underline{D}} = \sum_{i=1}^p S_i \underline{\underline{\alpha}}_i \otimes \underline{\underline{n}}_i. \quad (33)$$

4.2. Implementation of the kinematic approach

Taking into account the fact that in the definition (3) of π^{hom} the minimization process may be restricted to velocity fields satisfying (32), it is

$$\pi^{hom}(\underline{\underline{D}}) = \min\{\pi(\underline{\underline{d}}); \underline{\underline{v}} \text{ satisfying (32) and (33)}\}, \quad (34)$$

or

$$\pi^{hom}(\underline{\underline{D}}) = \min\left\{\sum_{i=1}^p S_i \pi(\underline{\underline{n}}_i, \underline{\underline{\alpha}}_i); \underline{\underline{\alpha}}_i | \underline{\underline{D}} = \sum_{i=1}^p S_i \underline{\underline{\alpha}}_i \otimes \underline{\underline{n}}_i\right\}. \quad (35)$$

Moreover, as shown by formula (25), only velocities $\underline{\underline{\alpha}}_i$ subject to conditions $\underline{\underline{\alpha}}_i \cdot \underline{\underline{n}}_i \geq |\underline{\underline{\alpha}}_i| \sin \varphi$ are to be explored in the above minimization process.

Equation (35) may finally be rewritten as

$$\pi^{hom}(\underline{\underline{D}}) = \frac{c}{\tan \varphi} \times \min\left\{\sum_{i=1}^p \underline{\underline{\beta}}_i \cdot \underline{\underline{n}}_i; \underline{\underline{\beta}}_i | \underline{\underline{D}} = \sum_{i=1}^p \underline{\underline{\beta}}_i \otimes \underline{\underline{n}}_i \text{ and } \underline{\underline{\beta}}_i \cdot \underline{\underline{n}}_i \geq |\underline{\underline{\beta}}_i| \sin \varphi \forall i\right\}, \quad (36)$$

with $\underline{\underline{\beta}}_i = S_i \underline{\underline{\alpha}}_i$.

Because, from (33), $\text{tr}(\underline{\underline{D}}) = \sum_{i=1}^p \underline{\underline{\beta}}_i \cdot \underline{\underline{n}}_i$,

$$\pi^{hom}(\underline{\underline{D}}) = \begin{cases} \frac{c}{\tan \varphi} \text{tr}(\underline{\underline{D}}) & \text{if } \underline{\underline{D}} \in \mathcal{C}, \\ +\infty & \text{otherwise,} \end{cases} \quad (37)$$

where $\mathcal{C} \subset \mathbb{R}^6$ denotes the cone of outer normals to G^{hom} , defined by

$$\underline{\underline{D}} \in \mathcal{C} \Leftrightarrow \exists \underline{\underline{\beta}}_i | \forall i \underline{\underline{\beta}}_i \cdot \underline{\underline{n}}_i \geq |\underline{\underline{\beta}}_i| \sin \varphi; \underline{\underline{D}} = \sum_{i=1}^p \underline{\underline{\beta}}_i \otimes \underline{\underline{n}}_i. \quad (38)$$

It follows from the kinematic definition of G^{hom} , expressed by (6), that

$$G^{hom} = \bigcap_{\underline{\underline{D}} \in \mathcal{C}} \left\{ \underline{\underline{\Sigma}} | \underline{\underline{\Sigma}} : \underline{\underline{D}} - \frac{c}{\tan \varphi} \text{tr}(\underline{\underline{D}}) = \left(\underline{\underline{\Sigma}} - \frac{c}{\tan \varphi} \underline{\underline{1}} \right) : \underline{\underline{D}} \leq 0 \right\} \quad (39)$$

It follows from (38) and (39) that G^{hom} , which may be drawn in \mathbb{R}^6 as the convex envelope of tangent hyperplanes normal to $\underline{\underline{D}} \in \mathcal{C}$, is a cone of vertex $\underline{\underline{\Sigma}} = (c/\tan \varphi) \underline{\underline{1}}$ (Figure 6).

The kinematic characterization of $g^{hom}(N)$ is automatically derived from (17):

$$\pi^{hom}(N, [\underline{\underline{v}}]) = \pi^{hom}(\underline{\underline{D}} = \underline{\underline{v}} \otimes N) = \begin{cases} \frac{c}{\tan \varphi} [\underline{\underline{v}}] \cdot N & \text{if } [\underline{\underline{v}}] \in \mathcal{C}(N), \\ +\infty & \text{otherwise,} \end{cases} \quad (40)$$

where

$$\mathcal{C}(N) = \{[\underline{\underline{v}}] | \underline{\underline{D}} = [\underline{\underline{v}}] \otimes N \in \mathcal{C}\}. \quad (41)$$

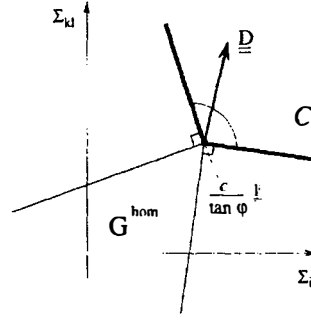

Figure 6. Cone of outer normals to G^{hom}

In the same way as G^{hom} , $g^{hom}(N)$ may be constructed as a convex envelope of planes in the space \mathbb{R}^3

$$g^{hom}(N) = \bigcap_{\underline{v} \in \mathcal{C}(N)} \left\{ \underline{T} \left(\underline{T} - \frac{c}{\tan \varphi} \underline{N} \right) \cdot \underline{v} \leq 0 \right\}. \quad (42)$$

It is a cone whose vertex is defined by $\underline{T} = (c / \tan \varphi) \underline{N}$

5. CASE OF A ROCK MASS WITH A SINGLE NETWORK OF PARALLEL JOINTS

This case corresponds to $p = 1$.

5.1. Domain G^{hom}

\underline{n}_1 being the unit normal to the joints, definition (22) of the corresponding convex $G_{(\underline{n}_1)}^{hom}$, where \mathcal{G}_1 is defined by (24), reduces in this case to

$$\underline{\Sigma} \in G_{(\underline{n}_1)}^{hom} \Leftrightarrow |\underline{\Sigma} \cdot \underline{n}_1 - (\underline{n}_1 \cdot \underline{\Sigma} \cdot \underline{n}_1) \underline{n}_1| \leq c - (\underline{n}_1 \cdot \underline{\Sigma} \cdot \underline{n}_1) \tan \varphi \quad (43)$$

The kinematic characterization of this convex is completely specified by means of $\mathcal{C}_{(\underline{n}_1)}$, that is the set of relevant macroscopic strain rates. Indeed (38) can be written as

$$\underline{D} \in \mathcal{C}_{(\underline{n}_1)} \Leftrightarrow \exists \beta | \underline{\beta} \cdot \underline{n}_1 \geq |\underline{\beta}| \sin \varphi; \underline{D} = \underline{\beta} \otimes \underline{n}_1. \quad (44)$$

Let us assume now that the physical space is referred to an orthonormal frame (e_1, e_2, e_3) with $\underline{e}_1 = \underline{n}_1$. Equations (43) and (44) may be rewritten as follows

$$\underline{\Sigma} = \sum_{i,j} \Sigma_{ij} \underline{e}_i \otimes \underline{e}_j \in G_{(\underline{n}_1)}^{hom} \Leftrightarrow \sqrt{\Sigma_{12}^2 + \Sigma_{13}^2} \leq c - \Sigma_{11} \tan \varphi \quad (45)$$

and

$$\underline{D} = \sum_{i,j} D_{ij} \underline{e}_i \otimes \underline{e}_j \in \mathcal{C}_{(\underline{n}_1)} \Leftrightarrow \{D_{ij} = 0 \text{ if } i \neq 1 \text{ and } j \neq 1, 2 \tan \varphi \sqrt{D_{12}^2 + D_{13}^2} \leq D_{11}\}. \quad (46)$$

Consequently, $G_{(n_1)}^{hom}$ may be defined in an equivalent manner by

$$G_{(n_1)}^{hom} = \bigcap_{2 \tan \varphi \sqrt{D_{12}^2 + D_{13}^2} \leq D_{11}} \left\{ \underline{\Sigma} \left(\Sigma_{11} - \frac{c}{\tan \varphi} \right) D_{11} + 2\Sigma_{12}D_{12} + 2\Sigma_{13}D_{13} \leq 0 \right\}. \quad (47)$$

To illustrate the anisotropic properties of the strength criterion thus obtained, we suppose that a representative volume of intact rock and joints is subjected to uniaxial tension (resp. uniaxial compression) acting in the plane (e_1, e_2) . Let $\chi \in [0, 90^\circ]$ be the orientation of the uniaxial loading with respect to $e_1 = n_1$. Denoting by $\Sigma^+(\chi)$ and $\Sigma^-(\chi)$ the tensile and compressive strengths of the

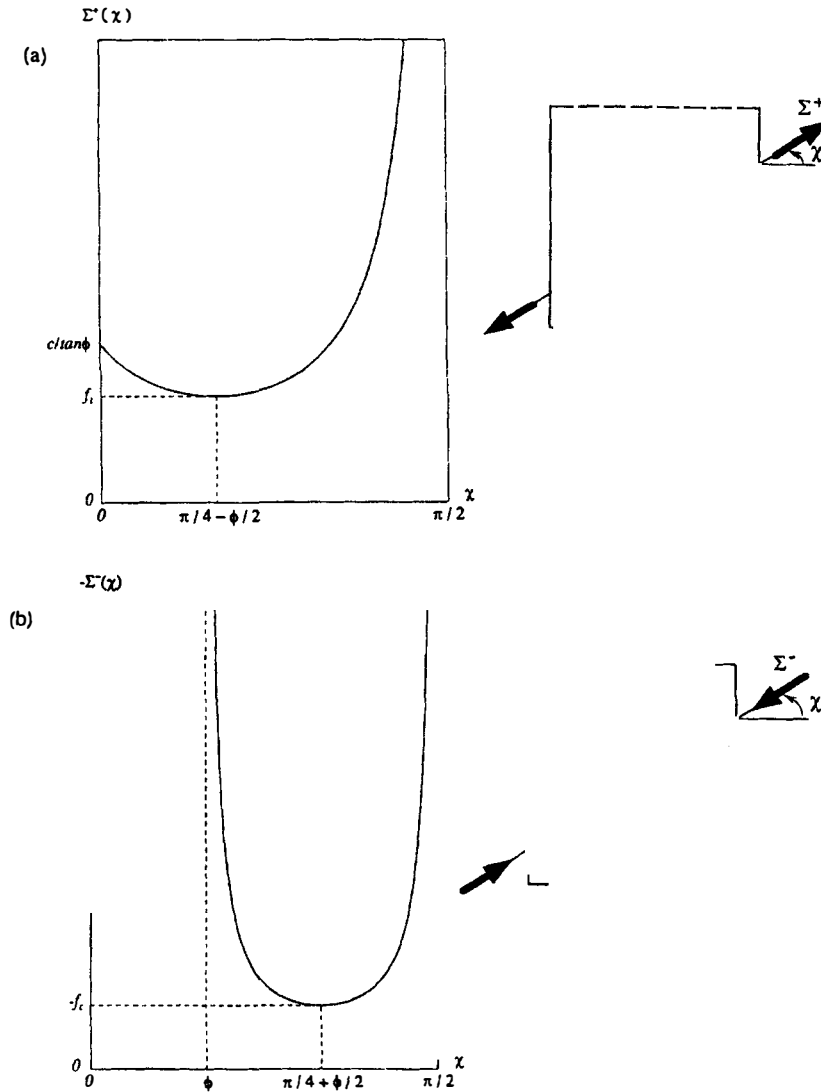

Figure 7. Macroscopic uniaxial tensile and compressive strengths of single jointed rock

composite, it comes from (45) that

$$\Sigma^+(\chi)/c = \frac{\cos \varphi}{\cos \chi \sin(\chi + \varphi)} \quad (48)$$

and

$$\Sigma^-(\chi)/c = \begin{cases} -\frac{\cos \varphi}{\cos \chi \sin(\chi - \varphi)} & \text{if } \chi \geq \varphi, \\ -\infty & \text{otherwise.} \end{cases} \quad (49)$$

Figure 7 displays the variation of the above quantities as functions of χ . In this figure $f_t = 2c \cos \varphi / (1 + \sin \varphi)$ and $f_c = -2c \cos \varphi / (1 - \sin \varphi)$ are the strengths in simple tension and simple compression of an isotropic material whose strength capacities are described by a Mohr-Coulomb criterion (c, φ) .

Remark. In the case of an intact rock material displaying limited isotropic strength properties ($G^m \neq \mathbb{R}^6$), equation (14) shows that the previous values of $\Sigma^+(\chi)$ and $\Sigma^-(\chi)$ should be truncated respectively by the strengths in simple tension and simple compression of the intact rock material. In this case, the above curves become similar to those given in Goodman.³³

5.2. Domain $g^{hom}(N)$

The construction of convex $g_{(n_1)}^{hom}(N)$ may be carried out by combining (41) and (42). Using the definition (46) of $\mathcal{G}_{(n_1)}$, it appears that three cases are to be considered (see Figure 8).

Case 1: $N \cdot n_1 = 1$

The cone $\mathcal{G}_{(n_1)}(N)$ is defined by

$$\mathcal{G}_{(n_1)}(N) = \{ \{v\} \| v \cdot n_1 \geq \|v\| \sin \varphi \}, \quad (50)$$

so that $g_{(n_1)}^{hom}$ reduces to the Coulomb's cone

$$g_{(n_1)}^{hom}(N) = \mathcal{G}_1. \quad (51)$$

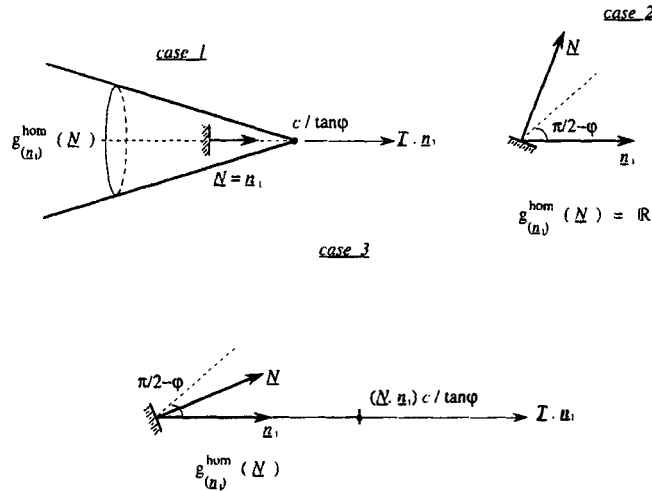

Figure 8. Sketch of the convex $g_{(n_1)}^{hom}(N)$ according to the orientation of N

Case 2: $0 \leq |\underline{N} \cdot \underline{n}_1| < \sin \varphi$

$$\mathcal{C}_{(\underline{n}_1)}(\underline{N}) = \{0\} \text{ and then } g_{(\underline{n}_1)}^{hom}(\underline{N}) = \mathbb{R}^3. \quad (52)$$

This shows that when considering a facet far too inclined with respect to the joints direction, the strength properties of the homogenized medium expressed on this facet tend to those of the intact rock.

Case 3: $\sin \varphi \leq |\underline{N} \cdot \underline{n}_1| < 1$

In this situation

$$\mathcal{C}_{(\underline{n}_1)}(\underline{N}) = \{[v] = V\underline{n}_1, V\underline{N} \cdot \underline{n}_1 \geq 0\}, \quad (53)$$

whence

$$g_{(\underline{n}_1)}^{hom}(\underline{N}) = \left\{ T \left(T - \frac{c}{\tan \varphi} \underline{N} \right) \cdot \underline{n}_1 \leq 0 \right\} \quad (54)$$

In the case when the considered facet is relatively close to the joints direction, domain $g_{(\underline{n}_1)}^{hom}$ reduces to the half-space of \mathbb{R}^3 containing the origin and bounded by the plane of normal \underline{n}_1 , passing through point $(c/\tan \varphi)\underline{N}$.

6. GENERAL CASE OF p NETWORKS OF PARALLEL JOINTS

In this section, it will be shown how the macroscopic strength capacities for a rock mass comprising several families of joints may be directly obtained from the case $p = 1$.

6.1. Domain G^{hom}

It results from (22) that

$$G_{(\underline{n}_1, \dots, \underline{n}_p)}^{hom} = \bigcap_{i=1}^p G_{(\underline{n}_i)}^{hom}, \quad (55)$$

which may be interpreted by saying that there is no ‘interaction’ between joints. $G_{(\underline{n}_1, \dots, \underline{n}_p)}^{hom}$ is then completely defined with the help of the results established in Section 5. More precisely, (55) may be expressed as

$$\underline{\underline{\Sigma}} \in G_{(\underline{n}_1, \dots, \underline{n}_p)}^{hom} \Leftrightarrow \begin{cases} \forall i = 1, p, \\ |\underline{\underline{\Sigma}} \cdot \underline{n}_i - (\underline{n}_i \cdot \underline{\underline{\Sigma}} \cdot \underline{n}_i)\underline{n}_i| \leq c - (\underline{n}_i \cdot \underline{\underline{\Sigma}} \cdot \underline{n}_i) \tan \varphi. \end{cases} \quad (56)$$

Owing to (33), the set $\mathcal{C}_{(\underline{n}_1, \dots, \underline{n}_p)}$ of relevant macroscopic strain rates is characterized by

$$\underline{\underline{D}} \in \mathcal{C}_{(\underline{n}_1, \dots, \underline{n}_p)} \Leftrightarrow \exists \underline{\underline{D}}_i \in \mathcal{C}_{(\underline{n}_i)} \quad i = 1, p \mid \underline{\underline{D}} = \sum_{i=1}^p \underline{\underline{D}}_i, \quad (57)$$

which may be rewritten as

$$\mathcal{C}_{(\underline{n}_1, \dots, \underline{n}_p)} = \mathcal{C}_{(\underline{n}_1)} + \dots + \mathcal{C}_{(\underline{n}_p)}. \quad (58)$$

This relation is simply the dual form of (55).

6.2. Domain $g^{hom}(\underline{N})$

The determination of convex $g_{(\underline{n}_1, \dots, \underline{n}_p)}^{hom}(\underline{N})$ may either be deduced from its definition by using (55), or more conveniently constructed by duality through the determination of the convex of its outer normals

$\mathcal{C}_{(\underline{n}_1, \dots, \underline{n}_p)}(\underline{N})$. This construction will be explicated for $p=2$ families of joints in the next section. Nevertheless, a first result may be established in the general case from the kinematic characterization definition of $\mathfrak{g}_{(\underline{n}_1, \dots, \underline{n}_p)}^{hom}(\underline{N})$. Indeed, considering the following definition,

$$[\underline{v}] \in \mathcal{C}_{(\underline{n}_1, \dots, \underline{n}_p)}(\underline{N}) \Leftrightarrow \exists \underline{D}_i \in \mathcal{C}_{(\underline{n}_i)} \mid [\underline{v}] \otimes \underline{N} = \sum_{i=1}^p \underline{D}_i, \quad (59)$$

it comes out that

$$\mathcal{C}_{(\underline{n}_1, \dots, \underline{n}_p)}(\underline{N}) \supseteq \sum_{i=1}^p \mathcal{C}_{(\underline{n}_i)}(\underline{N}), \quad (60)$$

which implies that

$$\mathfrak{g}_{(\underline{n}_1, \dots, \underline{n}_p)}^{hom}(\underline{N}) \subseteq \bigcap_{i,j} \mathfrak{g}_{(\underline{n}_i, \underline{n}_j)}^{hom}(\underline{N}) \subseteq \bigcap_{i=1}^p \mathfrak{g}_{(\underline{n}_i)}^{hom}(\underline{N}). \quad (61)$$

It is to be emphasized that the previous relationships do not reduce to equalities, as it has been noticed before. From a mathematical point of view, this is essentially due to the fact that, given any \underline{D} in \mathbb{R}^6 , it is not always possible to exhibit $[\underline{v}] \in \mathbb{R}^3$ such that $\underline{D} = [\underline{v}] \otimes \underline{N}$.

Relations (61) make it possible to get an upper bound estimate for $\mathfrak{g}_{(\underline{n}_1, \dots, \underline{n}_p)}^{hom}(\underline{N})$ from the case $p=1$, or more finely from the case $p=2$ developed in the next section.

7. ILLUSTRATION ON THE CASE OF TWO NETWORKS OF PARALLEL JOINTS

This case corresponds to $p=2$ and the normals to the joints are denoted by $\underline{n}_1, \underline{n}_2$ respectively. α being the angle $(\underline{n}_1, \underline{n}_2)$ and $\theta = \frac{1}{2}\pi - \alpha$, it is always possible to choose $0 \leq \alpha \leq \frac{1}{2}\pi$ and $0 \leq \theta \leq \frac{1}{2}\pi$. It is convenient to introduce the unit vector $\underline{n}_3 = \underline{e}_3$ normal to the plane $(\underline{n}_1 = \underline{e}_1, \underline{n}_2)$. To avoid any misunderstanding concerning these notations, it shall be specified that \underline{n}_3 does not represent the normal to any joint. All tensors will be expressed in the frame $(\underline{n}_1, \underline{n}_2, \underline{n}_3)$ (Figure 9).

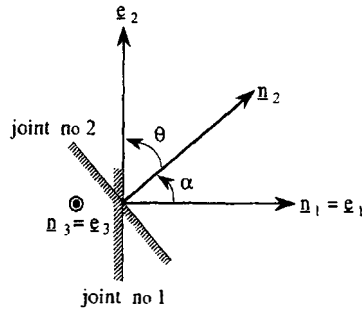

Figure 9. Frame adopted for a rock mass with two families of joints

7.1. Domain G^{hom} and relevant macroscopic strain rates

The macroscopic strength domain $G_{(\underline{n}_1, \underline{n}_2)}^{hom}$ is now given by:

$$\underline{\Sigma} = \sum_{i,j} \Sigma_{ij} \underline{n}_i \otimes \underline{n}_j \in G_{(\underline{n}_1, \underline{n}_2)}^{hom}$$

⇕

$$\left\{ \begin{array}{l} \text{for } (i, j) = (1, 2) \text{ and } (2, 1) \\ \sqrt{\cos^2 \theta (\sin \theta \Sigma_{jj} + \Sigma_{12})^2 + (\sin \theta \Sigma_{j3} + \Sigma_{i3})^2} \leq c - (\Sigma_{ii} + 2 \sin \theta \Sigma_{12} + \sin^2 \theta \Sigma_{jj}) \tan \varphi \end{array} \right. \quad (62)$$

(no summation over repeated subscripts).

Considering again the problem of macroscopic tensile and compressive strengths examined in Section 5.1, we suppose that the two networks of joints are perpendicular ($\theta = 0$), and denote by $\chi \in [0, 90^\circ]$ the orientation of the uniaxial loading (acting in the plane $(\underline{n}_1, \underline{n}_2)$) with respect to \underline{n}_1 . We obtain from (62) the following expressions for $\Sigma^+(\chi)$ and $\Sigma^-(\chi)$

$$\Sigma^+(\chi)/c = \frac{1}{\cos \chi \sin \chi + \max(\sin^2 \chi, \cos^2 \chi) \tan \varphi} \quad (63)$$

and

$$\Sigma^-(\chi)/c = \frac{1}{\cos \chi \sin \chi - \min(\sin^2 \chi, \cos^2 \chi) \tan \varphi}. \quad (64)$$

The variations of $\Sigma^+(\chi)$ and $\Sigma^-(\chi)$ versus χ are sketched in Figure 10. The same remark as that made in Section 5.1, holds for the case of intact rock with limited strength properties.

Concerning the determination of the cone $\mathcal{C}_{(\underline{n}_1, \underline{n}_2)}$, it appears from closely examining of the relation (57), that the two cases should be distinguished: $\theta \leq \varphi$ and $\theta \geq \varphi$. The results are summarized as follows.

1. $0 \leq \theta < \varphi$ ($\varphi < \alpha \leq \frac{1}{2}\pi$)

Let us first introduce angle $\tilde{\varphi} \in]0, \varphi]$ defined as

$$\tan \tilde{\varphi} = \sqrt{\tan^2 \varphi - \tan^2 \theta}, \quad (65)$$

then

$$\underline{D} = \sum_{i,j} D_{ij} \underline{n}_i \otimes \underline{n}_j \in \mathcal{C}_{(\underline{n}_1, \underline{n}_2)} \Leftrightarrow \left\{ \begin{array}{l} D_{33} = 0, \\ D_{ii} \geq 2 \tan \tilde{\varphi} |D_{i3}|, \quad i = 1, 2, \\ 2 \tan \tilde{\varphi} |\tilde{D}_{12}| \leq \sum_{i=1}^2 \sqrt{D_{ii}^2 - 4 \tan^2 \tilde{\varphi} D_{i3}^2}, \end{array} \right. \quad (66)$$

where

$$\tilde{D}_{12} = \cos \theta \frac{\tan \tilde{\varphi}}{\tan \varphi} D_{12} - \frac{\tan \theta}{2 \tan \varphi \tan \tilde{\varphi}} (D_{11} + D_{22}). \quad (67)$$

It should be pointed out that when the value of θ tends to 0 (case of two perpendicular joints), $\tilde{\varphi}$ tends to φ and \tilde{D}_{12} becomes identical to D_{12} .

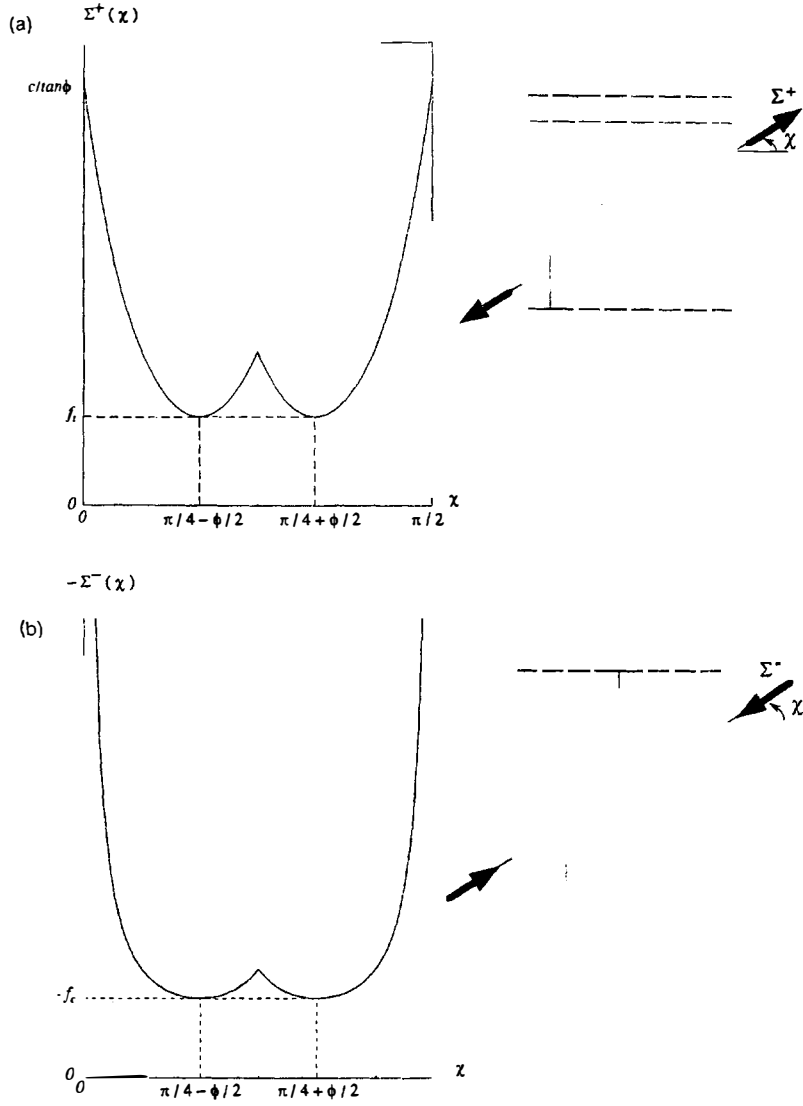

Figure 10. Macroscopic uniaxial tensile and compressive strengths for double jointed rock

2. $\varphi < \theta \leq \frac{1}{2}\pi (0 \leq \alpha < \varphi)$

One may easily establish that

$$\underline{\underline{D}} = \sum_{ij} D_{ij} \underline{n}_i \otimes \underline{n}_j \in \mathcal{C}_{(\underline{n}_1, \underline{n}_2)} \Leftrightarrow \begin{cases} D_{33} = 0, \\ 2 \tan \hat{\varphi} \hat{D}_{12} \geq \sum_{i=1}^2 \sqrt{D_{ii}^2 + 4 \tan^2 \hat{\varphi} D_{i3}^2}, \end{cases} \quad (68)$$

where

$$\tan \hat{\varphi} = \sqrt{\tan^2 \theta - \tan^2 \varphi} \quad (69)$$

and

$$\hat{D}_{12} = \cos \theta \frac{\tan \hat{\varphi}}{\tan \varphi} D_{12} + \frac{\tan \theta}{2 \tan \varphi \tan \hat{\varphi}} (D_{11} + D_{22}). \quad (70)$$

7.2. Relevant velocity jumps

The construction of the cone $\mathcal{C}_{(\underline{n}_1, \underline{n}_2)}(\underline{N})$ is obtained from the results given in Section 7.1. All the vectors will be referred to through their components in the frame $(\underline{n}_1, \underline{n}_2, \underline{n}_3)$.

1. $0 \leq \theta < \varphi$

Keeping in mind that N_1, N_2, N_3 are the components of \underline{N} in the frame $(\underline{n}_1, \underline{n}_2, \underline{n}_3)$ and taking into account (66) it turns out that

$$\begin{aligned} [\underline{v}] &= \sum_{i=1}^3 v_i \underline{n}_i \in \mathcal{C}_{(\underline{n}_1, \underline{n}_2)}(\underline{N}) \\ &\Leftrightarrow \\ &\begin{cases} N_3 v_3 = 0, \\ N_i v_i \geq \tan \varphi |N_3 v_i + N_i v_3|, \quad i = 1, 2, \\ |\tilde{N}_2 v_1 + \tilde{N}_1 v_2| \tan \tilde{\varphi} \leq \sum_{i=1}^2 \sqrt{N_i^2 v_i^2 - \tan^2 \tilde{\varphi} (N_3 v_i + N_i v_3)^2}, \end{cases} \end{aligned} \quad (71)$$

where $\tilde{\varphi}$ is defined by (65), and

$$\begin{aligned} \tilde{N}_1 &= \frac{\cos \theta \tan \tilde{\varphi}}{\tan \varphi} N_1 - \frac{\tan \theta}{\tan \varphi \tan \tilde{\varphi}} N_2, \\ \tilde{N}_2 &= \frac{\cos \theta \tan \tilde{\varphi}}{\tan \varphi} N_2 - \frac{\tan \theta}{\tan \varphi \tan \tilde{\varphi}} N_1, \end{aligned} \quad (72)$$

2. $\varphi < \theta < \frac{1}{2}\pi$

Taking into account (68) it comes out that

$$\begin{aligned} [\underline{v}] &= \sum_{i=1}^3 v_i \underline{n}_i \in \mathcal{C}_{(\underline{n}_1, \underline{n}_2)}(\underline{N}) \\ &\Leftrightarrow \\ &\begin{cases} N_3 v_3 = 0, \\ (\hat{N}_2 v_1 + \hat{N}_1 v_2) \tan \hat{\varphi} \geq \sum_{i=1}^2 \sqrt{N_i^2 v_i^2 + \tan^2 \hat{\varphi} (N_3 v_i + N_i v_3)^2}, \end{cases} \end{aligned} \quad (73)$$

where $\hat{\varphi}$ is defined by (69), and

$$\begin{aligned} \hat{N}_1 &= \frac{\cos \theta \tan \hat{\varphi}}{\tan \varphi} N_1 - \frac{\tan \theta}{\tan \varphi \tan \hat{\varphi}} N_2, \\ \hat{N}_2 &= \frac{\cos \theta \tan \hat{\varphi}}{\tan \varphi} N_2 - \frac{\tan \theta}{\tan \varphi \tan \hat{\varphi}} N_1, \end{aligned} \quad (74)$$

7.3. Convex $g_{(\underline{n}_1, \underline{n}_2)}^{hom}(\underline{N})$: the particular case of two perpendicular sets of joints

Since the relevant velocity jumps are now completely determined, the construction of the convex $g_{(\underline{n}_1, \underline{n}_2)}^{hom}(\underline{N})$ can be carried out automatically. Such a construction will be illustrated on the case of perpendicular joints (i.e. $\theta = 0$).

Due to obvious symmetry properties, one may restrict the study to $N_1 \geq N_2 \geq 0$. The following notation will be introduced

$$\underline{T}^* = \underline{T} - \frac{c}{\tan \varphi} \underline{N}. \quad (75)$$

It results from (71) that two cases have to be distinguished.

$N_3 \neq 0$

Referring to Figure 11, this situation means that the projection of \underline{N} onto the plane $(\underline{n}_1, \underline{n}_2)$ lies strictly inside the unit disk ($N_1^2 + N_2^2 < 1$). The cone $\mathcal{C}_{(\underline{n}_1, \underline{n}_2)}(\underline{N})$ is then defined by

$$[\underline{v}] = \sum_{i=1}^3 v_i \underline{n}_i \Sigma_{\mathcal{C}_{(\underline{n}_1, \underline{n}_2)}(\underline{N})} \Leftrightarrow \begin{cases} v_3 = 0, v_1 \geq 0, v_2 \geq 0, \\ \lambda_1 v_1^2 \geq 0, \lambda_2 v_2^2 \geq 0, \\ (N_2 v_1 + N_1 v_2) \tan \varphi \leq \sqrt{\lambda_1 v_1^2} + \sqrt{\lambda_2 v_2^2}, \end{cases} \quad (76)$$

where

$$\begin{aligned} \lambda_1 &= N_1^2 - N_3^2 \tan^2 \varphi = \tan^2 \varphi (N_1^2 / \sin^2 \varphi + N_2^2 - 1), \\ \lambda_2 &= N_2^2 - N_3^2 \tan^2 \varphi = \tan^2 \varphi (N_2^2 / \sin^2 \varphi + N_1^2 - 1). \end{aligned} \quad (77)$$

It is evident that if $\lambda_i < 0$, conditions (76) impose $v_i = 0$.

The combination of the kinematic definition of $g_{(\underline{n}_1, \underline{n}_2)}^{hom}(\underline{N})$ with (76) leads to distinguishing different zones in the plane (N_1, N_2) plane (Figure 11).

Zone (1): defined by $N_1 < \sin \varphi$; the above cone reduces to vector $\underline{0}$ and thus $g_{(\underline{n}_1, \underline{n}_2)}^{hom}(\underline{N}) = \mathbb{R}^3$.

In this case, like in Section 5.2, the presence of joints does not affect the strength capacities of the material in the direction \underline{N} .

zone (2): defined by $N_1 \geq \sin \varphi$ and $\lambda_2 < 0$. All elements of $\mathcal{C}_{(\underline{n}_1, \underline{n}_2)}(\underline{N})$ must satisfy $v_2 = v_3 = 0, v_1 \geq 0$, then

$$\underline{T} \in g_{(\underline{n}_1, \underline{n}_2)}^{hom}(\underline{N}) \Leftrightarrow T_1^* \leq 0. \quad (78)$$

In this case only joint n^o1 has an effect on the resistance of the homogenized material.

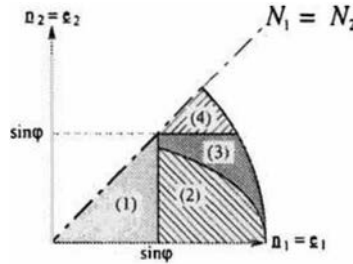

Figure 11. Domains of variation for the projection of \underline{N} onto the plane $(\underline{n}_1, \underline{n}_2)$

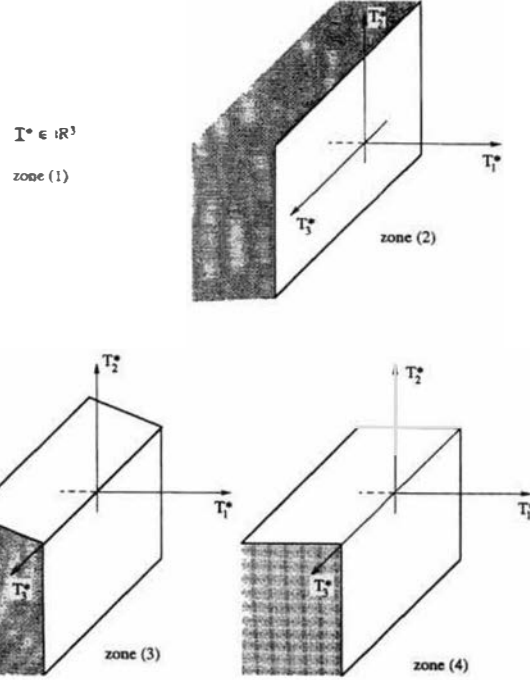

Figure 12. Sketch of the convex $g_{(n_1, n_2)}^{hom}(N)$ according to the orientation of \underline{N}

Zone (3): defined by $N_1 \geq \sin \varphi$, $N_2 \leq \sin \varphi$ and $\lambda_2 \geq 0$. $\mathcal{C}_{(n_1, n_2)}(\underline{N})$ is characterized by $v_3 = 0$, thus

$$\underline{T} \in g_{(n_1, n_2)}^{hom}(\underline{N}) \Leftrightarrow T_1^* \leq 0 \text{ and } T_2^* \leq \frac{N_1 \tan \varphi - \sqrt{\lambda_2}}{N_2 \tan \varphi - \sqrt{\lambda_1}} T_1^*. \quad (79)$$

Zone (4): defined by $N_1 \geq N_2 \geq \sin \varphi$. Elements of $\mathcal{C}_{(n_1, n_2)}(\underline{N})$ satisfy conditions $v_3 = 0$, $v_2 \geq 0$, $v_1 \geq 0$, thus

$$\underline{T} \in g_{(n_1, n_2)}^{hom}(\underline{N}) \Leftrightarrow T_1^* \leq 0 \text{ and } T_2^* \leq 0. \quad (80)$$

In zones 3 and 4, both joints 1 and 2 reduce the strength capacities of the homogenized material in the direction \underline{N} . These different situations are summarized in Figure 12.

$$N_3 = 0$$

It means that the extremity of the vector N lies on the unit circle ($N_1^2 + N_2^2 = 1$). The elements of the cone $\mathcal{C}_{(n_1, n_2)}(\underline{N})$ are now defined by

$$\begin{cases} v_1 \geq |v_3 \tan \varphi|, v_2 \geq |v_3 \tan \varphi|, \\ (N_2 v_1 + N_1 v_2) \tan \varphi \leq N_1 \sqrt{v_1^2 - v_3^2 \tan^2 \varphi} + N_2 \sqrt{v_2^2 - v_3^2 \tan^2 \varphi}. \end{cases} \quad (81)$$

Since

$$\underline{T} \in g_{(n_1, n_2)}^{hom}(\underline{N}) \Leftrightarrow \forall (v_1, v_2, v_3) \text{ satisfying (81), } v_1 T_1^* + v_2 T_2^* + v_3 T_3^* \leq 0 \quad (82)$$

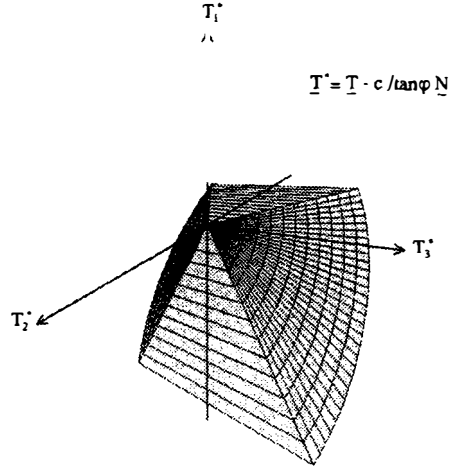

Figure 13. Strength domain $g_{(n_1, n_2)}^{hom}(\underline{N})$ for $\varphi = 30^\circ$, $N_3 = 0$ and $N_1 = N_2$

it comes out that $g_{(n_1, n_2)}^{hom}(\underline{N})$ is a cone whose vortex coincides with the origin of the frame (T_1^*, T_2^*, T_3^*) . It can be derived from (82) that this domain is defined by

$$\begin{cases} T_1^* \leq 0, \\ T_2^* \leq T_1^* \inf \left(0, \frac{N_1 \tan \varphi - N_2}{N_2 \tan \varphi - N_1} \right) \\ |T_3^*| \leq \min_{\mu} \left[\frac{T_1^* \tan \varphi}{\sqrt{1 - \left(\frac{N_1}{\mu T_1^* + N_2 \tan \varphi} \right)^2}} - \frac{T_2^* \tan \varphi}{\sqrt{1 - \left(\frac{N_2}{\mu T_2^* + N_1 \tan \varphi} \right)^2}} \right] \end{cases} \quad (83)$$

where μ satisfies conditions: $\mu \leq 0$, $\mu T_1^* + N_2 \tan \varphi > N_1$, $\mu T_2^* + N_1 \tan \varphi > N_2$.

To illustrate such a domain $g_{(n_1, n_2)}^{hom}(\underline{N})$ is sketched in Figure 13 for $\varphi = 30^\circ$ and $N_1 = N_2$.

8. CONCLUDING REMARKS

Based upon the yield design homogenization theory, a three-dimensional closed-form formulation of the strength capacities of jointed rocks (at a macroscopic scale) is derived in this paper from the sole knowledge of the strength characteristics of the intact rocks and of the joints. Even if a general formulation of the macroscopic strength domain G^{hom} has been given, the study has been more particularly focused on the case of an infinitely resistant intact rock. Attention has been given to the characterization of the domain $g^{hom}(\underline{N})$ which represents the set of admissible stress vectors acting upon any elementary surface, of normal \underline{N} , of the homogenized media.

The results derived here make it possible to deal with the stability analysis of structures made up of rock cut by joints (like slopes as exposed in the introduction on Figure 1, underground excavations, ...), by means of the static and the kinematic approaches of the yield design theory, implemented directly on the homogenized structure. Indeed, since explicit expressions of the support-functions π^{hom} have been established for the homogenized material, the use of failure mechanisms

involving deformation or velocity jumps becomes now possible. That will constitute the next step of this work, and the results could then be compared to those derived from classical analyses.

Further developments may be envisaged in the future:

- (i) the development of the approach when a finite yield condition is taken into account for the intact rock.
- (ii) as mentioned above, the use of such a criterion for carrying out stability analysis of structures made up of jointed rock masses.
- (iii) finally, as it has been already done for soils or rocks reinforced by inclusions,³⁴ the derivation of an elastic plastic constitutive law for the jointed rock mass regarded as a homogenized anisotropic medium on the macroscopic scale.

ACKNOWLEDGEMENTS

The authors are very grateful to Professor P. de Buhan for his helpful suggestions and criticisms.

APPENDIX A. PROOF OF IDENTITY (14)

To establish the identity $G_{int} = G'_{int}$, we proceed in two steps.

Step 1

Let $\underline{\underline{\Sigma}} \in G_{int}$. We define the homogeneous stress field $\underline{\underline{\sigma}}$ on \mathcal{A} by

$$\underline{\underline{\sigma}}(x) = \underline{\underline{\Sigma}}, \forall x \in \mathcal{A},$$

$\underline{\underline{\Sigma}} = \langle \underline{\underline{\sigma}} \rangle$ and from the definition (12) of G'_{int} , it comes that $\underline{\underline{\Sigma}} \in G'_{int}$. Subsequently

$$G_{int} \subseteq G'_{int}. \quad (A1)$$

Step 2

Let $\underline{\underline{\Sigma}} \notin G_{int}$. From definition (13), it means that there exists $i0$ such that $\underline{\underline{\Sigma}} \cdot \underline{n}_{i0} \notin \mathcal{G}_{i0}$, which, when using the kinematic characterization of \mathcal{G}_{i0} , means that

$$\exists w \in \mathbb{R}^3 | (\underline{\underline{\Sigma}} \cdot \underline{n}_{i0}) \cdot w > \pi(\underline{n}_{i0}, w), \quad (A2)$$

where $\pi(\underline{n}_{i0}, \cdot)$ denotes the support function of the convex \mathcal{G}_{i0} .

For the sake of clarity, we assume that the unit cell is a cube of unit side (the demonstration for a general parallelepipedic volume shape is quite analogous). The plane (joint) P_{i0} divides the unit cell \mathcal{A} into two domains \mathcal{A}^+ and \mathcal{A}^- (Figure 14).

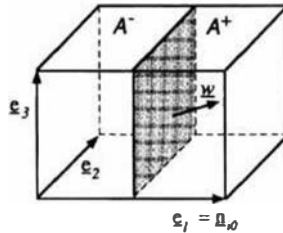

Figure 14.

Let us define now the velocity field \underline{v} by

$$\underline{v}(\underline{x}) = \begin{cases} \underline{0} & \text{if } \underline{x} \in \mathcal{A}^-, \\ \underline{w} & \text{if } \underline{x} \in \mathcal{A}^+. \end{cases}$$

The above velocity is discontinuous when crossing P_{i0} , and $[\underline{v}] = \underline{w}$, $\forall \underline{x} \in P_{i0}$. Its associated tensors \underline{F} and \underline{D} are equal to

$$\underline{F} = S_{i0}(\underline{w} \otimes \underline{n}_{i0}), \underline{D} = S_{i0}(\underline{w} \otimes \underline{n}_{i0}),$$

where S_{i0} ($= 1$ here) is the surface of P_{i0} enclosed in \mathcal{A} .

We will establish now that the associated velocity field $\underline{u} = \underline{v} - \underline{F}\underline{x}$ is periodic on \mathcal{A} .

- *Faces of \mathcal{A} normal to \underline{e}_3 .*

For all \underline{x} and \underline{x}' situated on these faces and such as $\underline{x} - \underline{x}' = \underline{e}_3$

$$\underline{u}(\underline{x}) - \underline{u}(\underline{x}') = -\underline{F} \cdot \underline{e}_3 = -S_{i0}(\underline{n}_{i0} \cdot \underline{e}_3)\underline{w} = \underline{0}.$$

The same result is obtained when considering the *faces of $\partial\mathcal{A}$ normal to \underline{e}_2* .

- *Faces of $\partial\mathcal{A}$ normal to $\underline{e}_1 = \underline{n}_{i0}$.*

Let \underline{x} and \underline{x}' situated on these faces and such as $\underline{x} - \underline{x}' = \underline{e}_1$, it comes that

$$\underline{u}(\underline{x}) - \underline{u}(\underline{x}') = \underline{w} - \underline{F} \cdot \underline{e}_1 = (1 - S_{i0})\underline{w} = \underline{0},$$

which ends the proof that \underline{u} is periodic. So, the velocity field \underline{v} defined above is kinematically admissible with $\underline{D} = S_{i0}(\underline{w} \otimes \underline{n}_{i0})$. Moreover

$$\underline{\Sigma} : \underline{D} = S_{i0}(\underline{\Sigma} \cdot \underline{n}_{i0})\underline{w}$$

and, \underline{d} being the strain rate associated with \underline{v} ,

$$\langle \pi(\underline{d}) \rangle = \int_{P_{i0}} \pi(\underline{n}_{i0}, \underline{w}) \, dS = S_{i0} \pi(\underline{n}_{i0}, \underline{w}).$$

Taking into account (A2), it comes that

$$\underline{\Sigma} : \underline{D} > \langle \pi(\underline{d}) \rangle \geq \pi^{hom}(\underline{D}), \quad (\text{A3})$$

where π^{hom} denotes the support function of the convex G'_{int} .

Equation (A3) proves, when adopting the kinematic characterization, that $\underline{\Sigma} \notin G_{int}$. Thus

$$G'_{int} \subseteq G_{int}. \quad (\text{A4})$$

The combination of (A1) and (A4) leads to identity (14).

APPENDIX B. PROOF OF ASSERTION (29)

As in Appendix A, and for sake of clarity, the unit cell \mathcal{A} is assumed to have a cubic shape of unit side. The velocity field is defined by (26) and the associated tensor F_i is given by (28).

Let $\underline{x}_1, \underline{x}_2, \underline{x}'_1, \underline{x}'_2$ be any points (Figure 15) situated on the sides of \mathcal{A} whose normal is $\underline{n}_i = \underline{e}_i$, and such that

$$\underline{x}_1 - \underline{x}'_1 = \underline{x}_2 - \underline{x}'_2 = \underline{e}_i. \quad (\text{B1})$$

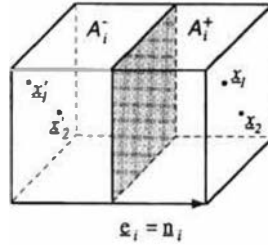

Figure 15.

As indicated on the above figure, x_1 and x_2 are on the side P_0 of equation $\underline{x} \cdot \underline{e}_i = 1$, x_1' and x_2' are on the side P_0' of equation $\underline{x} \cdot \underline{e}_i = 0$.

The periodicity of $\underline{u} = \underline{v}_i - \underline{F}_i \cdot \underline{x}$ implies that the following equalities

$$\underline{u}(x_1) = \underline{u}(x_1'), \quad \underline{u}(x_2) = \underline{u}(x_2'), \quad (B2)$$

must be satisfied.

Equations (B1) and (B2) imply that

$$\underline{\omega}_i \wedge (\underline{x}_1 - \underline{x}_2) = \underline{0} \quad \forall (\underline{x}_1, \underline{x}_2) \in P_0 \times P_0, \quad (B3)$$

which is possible if and only if $\underline{\omega}_i = 0$.

Now, as $\underline{\omega}_i = \underline{0}$, the expression of the elementary velocity field v_i reduces to that given by (30), and its periodicity is established in Appendix A.

REFERENCES

1. F. A. Donath, 'Experimental study of shear failure in anisotropic rock', *Bull. Geol. Soc. Am.*, **72**, 985-990 (1961).
2. E. Hoek, 'Fracture of anisotropic rock', *J. S. Afr. Inst. Min. Metall.*, **64**, 501-518 (1964).
3. R. V. De la Cruz, 'Modified borehole jack method for elastic property determination in rocks', *Rock mechanics*, **1**, 221-239 (1978).
4. D. Alliro and J. P. Boehler, 'Fracture of anisotropic rock', *J. S. Inst. Min. Metall.*, **64**, 501-518 (1979).
5. S. D. Priest, 'The use of hemisphere projection methods for the determination of kinematic feasibility, slide direction and volume of rock blocks', *Int. J. Rock Mech. Min. Sci. Geomech. Abstr.*, **17**, 1-23 (1980).
6. J. M. Lucas, 'A general stereographic method for determining the possible mode of failure of any tetrahedral rock wedge', *Int. J. Rock Mech. Min. Sci. Geomech. Abstr.*, **17**, 57-61 (1980).
7. P. M. Warburton, 'Vector stability analysis of an arbitrary polyhedral rock block with any number of free faces', *Int. J. Rock Mech. Min. Sci. Geomech. Abstr.*, **18**, 415-427 (1981).
8. P. A. Cundall and O. D. L. Strack, 'A discrete numerical model for granular assemblies', *Geotechnique*, **29**, 47-65 (1979).
9. P. A. Cundall and R. D. Hart, 'Development of generalized 2-D and 3-D distinct element programs for modeling jointed rock', Itasca Consulting Group, Misc. Paper SL-85-1, U.S. Army Corps of Engineers (1985).
10. P. A. Cundall, 'Formulation of a three-dimensional distinct element model—Part I. A scheme to detect and represent contacts in a system composed of many Polyhedral blocks', *Int. J. Rock Mech. Min. Sci. Geomech. Abstr.*, **25**, 107-116 (1988).
11. R. Hart, P. A. Cundall and J. Lemos, 'Formulation of a three-dimensional distinct element model—Part II. Mechanical calculations for motion and interaction of a system composed of many Polyhedral blocks', *Int. J. Rock Mech. Min. Sci. Geomech. Abstr.*, **25**, 117-125 (1988).
12. N. R. Barton, 'A relationship between joint roughness and joint shear strength', in *Proc. Int. Symp. Rock Fracture*, Nancy, France, pp. 1-8, 1971.
13. N. R. Barton, 'Review of a new shear strength criterion for rock joints', *Engng. Geol.*, **7**, 287-332 (1973).
14. N. R. Barton and V. Choubey, 'The shear strength of rock joints in theory and practice', *Rock Mech.*, **10**, 1-54 (1977).
15. Z. T. Bieniawski, 'Estimating the strength of rock materials', *J. S. Afr. Inst. Min. Metall.*, **74**, 312-320 (1974).
16. E. Hoek and E. T. Brown, 'Empirical strength criterion for rock masses', *J. Geotech. Engng. Div. Am. Soc. Civ. Engrs.*, **106**, 1013-1035 (1980).
17. E. Hoek, 'Strength of jointed rock masses', *Geotechnique*, **33**, 187-223 (1983).
18. J. C. Jaeger, 'Shear failure of anisotropic rocks', *Geol. Mag.*, **97**, 65-72 (1960).
19. B. Ladanyi and G. Archambault, 'Evaluation de la résistance au cisaillement d'un massif rocheux fragmenté', in *Proc. 24th Int. Geol. Congress*, Montreal, Canada, pp. 249-260, 1972.

20. R. McLamore and K. E. Gray, 'The mechanical behavior of anisotropic sedimentary rocks', *J. Engng Indus., Trans. ASME*, **89**, 62–73 (1967).
21. W. G. Pariseau, 'Plasticity theory for anisotropic rocks and soils', in *Proc. 10th Symp. on Rock Mech.*, pp. 267–295, 1972.
22. J. P. Boehler and A. Sawdzuck, 'On yielding of oriented solids', *Acta mech.*, **27**, 185–206 (1977).
23. R. Nova, 'The failure of transversely isotropic rocks in triaxial compression', *Int. J. Rock Mech. Min. Sci.*, **17**, 325–332 (1980).
24. P. de Buhan and J. Salençon, *Yield strength of reinforced soils as anisotropic media* (ed. J. P. Boehler), Mechanical Engineering Publications, London, 1990.
25. P. de Buhan and A. Taliercio, 'A homogenization approach to the yield strength of composite materials', *Eur. J. Mech. A*, **10**, 129–154 (1991).
26. B. Amadei and R. E. Goodman, 'A 3-D constitutive relation for fractured rock masses', in *Proc. Int. Symp. Mech. Behav. of Struc. Media.*, Ottawa, pp. 249–268, 1981.
27. C. M. Gerrard, 'Equivalent elastic moduli of a rock mass consisting of orthorhombic layers', *Int. J. Rock Mech. Min. Sci. Geomech. Abstr.*, **19**, 9–14 (1982).
28. A. Taliercio and L. G. Sacchi, 'A failure condition for layered rocklike materials', *Int. J. Rock Mech. Min. Sci.*, **25**, 299–305 (1988).
29. P. Suquet, 'Analyse limite et homogénéisation', *CR Acad. Sc., Paris*, **296**, 1355–1358 (1983).
30. P. de Buhan, 'Approche fondamentale du calcul à la rupture des sols renforcés', Thèse d'Etat, Université Paris-VI, 1986.
31. J. Salençon, *Calcul à la rupture et analyse limite*, Presses de l'E.N.P.C., Paris, 1983.
32. J. Salençon, 'An introduction to the yield design theory and its application to soil mechanics', *Eur. J. Mech. A*, **9**, 477–500 (1990).
33. R. E. Goodman, *Methods for geological engineering in discontinuous rocks*, West Publ., St. Paul, 1976.
34. D. Bernaud, P. de Buhan and S. Maghous, 'Numerical Simulation of the convergence of a bolt-supported tunnel through a homogenization method', *Int. J. Num. Anal. Methods Geomech.*, **19**, 267–288 (1995).