



HAL
open science

**Safety of salt caverns used for underground storage.
Blow out ; mechanical instability ; seepage ; cavern
abandonment**

Pierre Bérest, Benoît Brouard

► **To cite this version:**

Pierre Bérest, Benoît Brouard. Safety of salt caverns used for underground storage. Blow out ; mechanical instability ; seepage ; cavern abandonment. Oil & Gas Science and Technology - Revue d'IFP Energies nouvelles, 2003, 58, pp.361-384. 10.2516/ogst:2003023 . hal-00111380

HAL Id: hal-00111380

<https://hal.science/hal-00111380>

Submitted on 28 Feb 2019

HAL is a multi-disciplinary open access archive for the deposit and dissemination of scientific research documents, whether they are published or not. The documents may come from teaching and research institutions in France or abroad, or from public or private research centers.

L'archive ouverte pluridisciplinaire **HAL**, est destinée au dépôt et à la diffusion de documents scientifiques de niveau recherche, publiés ou non, émanant des établissements d'enseignement et de recherche français ou étrangers, des laboratoires publics ou privés.

Safety of Salt Caverns Used for Underground Storage

Blow Out; Mechanical Instability; Seepage; Cavern Abandonment

P. Bérest¹ and B. Brouard²

¹ G.3S and LMS, École polytechnique - France

² LMS and Brouard Consulting - France

berest@lms.polytechnique.fr - brouard@lms.polytechnique.fr

Résumé — **Sécurité des cavernes de sel utilisées pour le stockage souterrain. Éruption ; instabilité mécanique ; perte d'étanchéité ; abandon des cavernes** — Des milliers de cavernes souterraines créées dans des massifs de sel (dont une centaine en France) sont utilisées pour stocker les hydrocarbures. Ce mode de stockage est le plus sûr pour de grands volumes d'hydrocarbures : les formations salines sont presque parfaitement imperméables, et l'incendie ou l'explosion sont impossibles sous terre en l'absence d'oxygène. Néanmoins, un petit nombre d'accidents sont survenus dans le passé : éruption, fuite des produits, instabilité des cavernes. L'abandon des cavernes est une préoccupation plus récente. Cet article décrit plusieurs accidents, et les leçons qui ont pu en être tirées. Elles ont conduit à une amélioration considérable de la conception et l'exploitation de ces ouvrages.

Abstract — **Safety of Salt Caverns Used for Underground Storage. Blow Out; Mechanical Instability; Seepage; Cavern Abandonment** — Thousands of salt caverns (100 in France alone) are being used to store hydrocarbons. This is the safest way to store large quantities of hydrocarbons: salt formations are almost perfectly impermeable, and fire or explosion is impossible underground. However, a small number of accidents (blow-out, product seepage, cavern instability) have occurred in the past. Cavern abandonment is also a concern in some cases. This paper describes several accidents and the lessons that have been drawn from them, leading to considerable improvements in storage design and operation.

INTRODUCTION: SOLUTION-MINED CAVERNS

This paper focuses on the safety of deep underground salt caverns used to store hydrocarbons. By “deep”, we mean caverns with depths ranging between 500 and 2000 m. These caverns have been leached out from salt formations: a (typical) 1 km deep well is cased and cemented to the rock formation, and the casing-shoe is anchored to the upper part of the salt formation. A central string is set inside the well, like a straw in a bottle, allowing soft water to be injected at the bottom of the cavern. Water leaches the salt wall, and brine is removed from the cavern through the annular space between the cemented casing and the central injection tube. After a year or more, a 10 000 m³ to 1 000 000 m³ cavern will be created (Fig. 1). In many cases, the cavern is used later for hydrocarbon storage (crude oil, liquefied petroleum gas (LPG) or natural gas): some brine is removed from the cavern, and hydrocarbons are substituted for the removed brine. Generally, one to several strings are set in the well to allow injection or withdrawal of fluids into or from the cavern.

Thousands of such caverns have been implemented throughout the world (Thoms and Gehle, 2000). Literature is abundant on all aspects of solution-mining techniques, including safety. The *Solution Mining Research Institute (SMRI)*, which gathers companies, consultants and research centers involved in the solution-mining industry, has published hundreds of technical papers dedicated to solution-mined caverns.

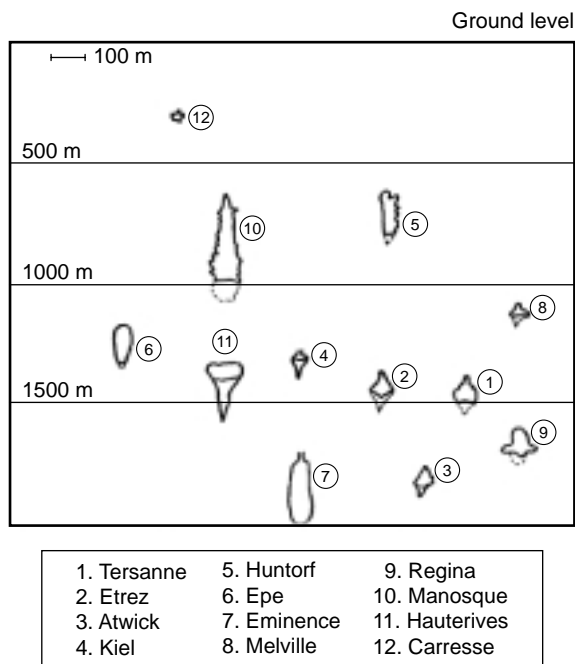

Figure 1
Solution-mined caverns.

Storage-Cavern Safety

Underground storage is the safest way to store large quantities of hydrocarbons. This statement may seem paradoxical as a topic of a paper concerning risks, hazards and accident reports. In fact, however, judging the safety of any type of facility must be based on an estimate of the shortcomings of alternative systems. Hydrocarbons can be stored in underground storage facilities, or in steel and concrete tank farms at the ground surface. Underground storage facilities are much safer in terms of safety and environmental protection: salt formations are almost perfectly impermeable; underground, hydrocarbons are separated from the oxygen in the air (necessary for combustion) by several hundred meters of rock; this same natural barrier protects them from fire, willful damage and aircraft impact; high storage pressures present no problem insofar as high pressure is the natural state of the fluids underground; and, last but not least, underground storage is extremely economical in terms of land area.

However, hydrocarbons are valuable because they release large quantities of energy when they burn or explode. This makes them hazardous to transport or store. A few accidents happened in underground storages. Case histories of such accidents provide the best lessons for preventing further problems. It must be noticed that most accidents happened in old caverns, created at a time when few lessons could be drawn from experience and when less than stringent regulations existed. Much has been learned from hundreds of caverns operated for decades, leading to considerable improvements in the creation or operation of underground caverns. For instance, in Texas, which probably has the largest number of caverns in operation worldwide, constant improvements, reflected in the evolution of regulations, make the storage industry much safer than it used to be, especially when recently built caverns are considered.

1 FLUID EQUILIBRIUM IN A DEEP CAVERN (BLOW OUT)

1.1 Introduction

A storage cavern is a pressure vessel: high pressure fluids are contained in a stiff impervious envelope, and a system of valves allows the cavity to be sealed off. However, caverns differ from standard pressure vessels in two respects.

- The “container” consists of the access well and the cavern proper (typically, the height of such a system is 1 km). The well is equipped with several tubes containing various fluids (brine and hydrocarbons). Even a small difference in fluid density results in significantly different column weights. The gap between the pressures of fluids, contained in two different tubes at the same depth, can be several

MPa large. When the various fluids come into direct contact accidentally, unstable situations are generated.

- The volume of a cavern body is very large (up to 1 000 000 m³). Even a small pressure drop results in a significant change in the volume of the stored product. Liquid compressibility, an often negligible notion in most above-ground vessels, plays a significant role when large underground caverns are considered.

How these two factors generate specific difficulties is described below.

1.2 Pressure Distribution in a Salt Cavern – Consequences of Well Failure

1.2.1 Liquid and Liquefied Products

Storage facilities for liquids (oil, naphtha, kerosene, gasoline) and liquefied hydrocarbons (LPG, ethylene, propylene) are operated by the “brine compensation” method. As brine is injected through a tubing (Fig. 2) at the bottom of the cavern, an equivalent volume of products is withdrawn through the annular space between the steel cemented casing and the central tube. When the cavern is idle, the brine is at atmospheric pressure at ground level.

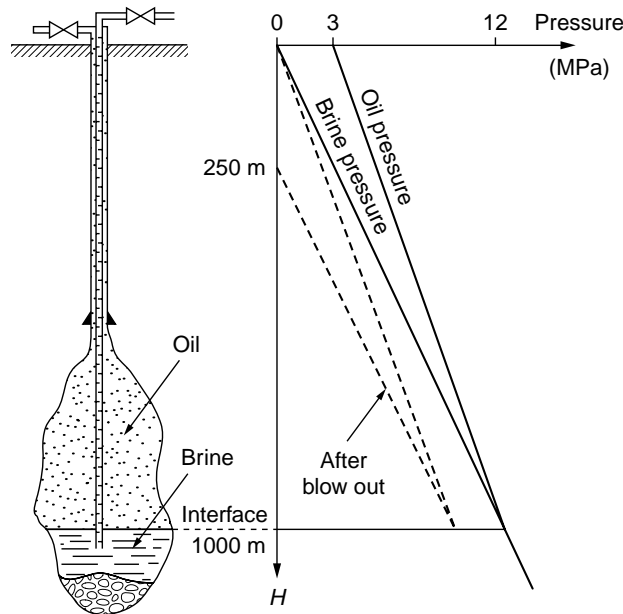

Figure 2

Pressure distribution before and after a blow out. Oil and brine pressures are equal at interface depth; oil pressure is larger at smaller depth. After a blow out (dashed lines), pressures drop as the air/brine interface lowers in the tubing.

In the brine tube, however, the pressure is in proportion to the depth and specific density of brine, which is of the order of 1200 kg · m⁻³. If the interface between the oil and brine is 1000 m below ground level, the pressure at this point will be approximately 12 MPa. At the interface, brine pressure and product pressure are equal. Above this point, the pressure in the product-filled annular space reduces gradually, although this occurs more slowly than in brine because the density of the product is lower (of the order of 900 kg · m⁻³ for oil, and 500 kg · m⁻³ for LPG).

At a given depth, the pressure in the annular space is higher than the pressure in the central tube. The difference is greatest at ground level, where, as in our example, it is 3 MPa (for oil storage) or 7 MPa (for LPG storage). At the wellhead, the stored product applies pressure to the valve controlling the annular space. If this valve fails (in Texas, emergency shutdown valves must be installed on the product and brine sides of each liquefied hydrocarbon storage well—*Texas Railroad Commission TAC § 3.95*—this does not apply to crude oil storage facilities), the product is ejected suddenly, and the brine level in the central string drops until a new balance is reached.

For an oil-storage cavern with an oil density of 900 kg · m⁻³ and with the initial oil/brine interface at a depth of 1000 m, the air/brine interface in the central tubing will come to rest at a depth of $h = 250$ m (see Fig. 3). The weights of the brine column and the oil column will then be equal at the oil/brine interface depth.

If fluids were incompressible, the volume of expelled oil would be small, because the tubing capacity is only a few dozen liters per meter length. In fact, due to the compressibility of oil, brine and the cavern itself, much more oil is expelled. The compressibility factor of brine is $\beta_b = 2.7 \cdot 10^{-4} \text{ MPa}^{-1}$; the compressibility factor of the cavern is $\beta_c = 1.3 \cdot 10^{-4} \text{ MPa}^{-1}$ (this figure can vary, depending on the elastic properties of rock salt and the cavern shape; see Bérest *et al.*, 1999); and the compressibility factor of the oil can be $\beta_o = 6 \cdot 10^{-4} \text{ MPa}^{-1}$. If x is the ratio between the stored-oil volume and the cavern volume, the global compressibility is:

$$\beta = \beta_c + x \beta_o + (1 - x) \beta_b \quad (1)$$

Following failure of the wellhead valve, the pressure of the entire body of stored fluids (oil and brine) will be reduced by $\Delta P_i = 3 \text{ MPa}$ (in the given example, see Fig. 2). If the cavity contains $V = 500\,000 \text{ m}^3$ of oil and very little brine ($x = 1$), then, because of the compressibility, the amount ejected will be:

$$\beta V \cdot \Delta P_i = 7.3 \cdot 10^{-4} \text{ MPa}^{-1} \cdot 500\,000 \text{ m}^3 \cdot 3 \text{ MPa} = 1100 \text{ m}^3.$$

For liquefied products, a limited amount of LPG would first be expelled in liquid form. However, this amount will be larger than in the case of oil, as the compressibility factor of LPG is larger, $\beta_p = 3 \cdot 10^{-3} \text{ MPa}^{-1}$. This liquid would

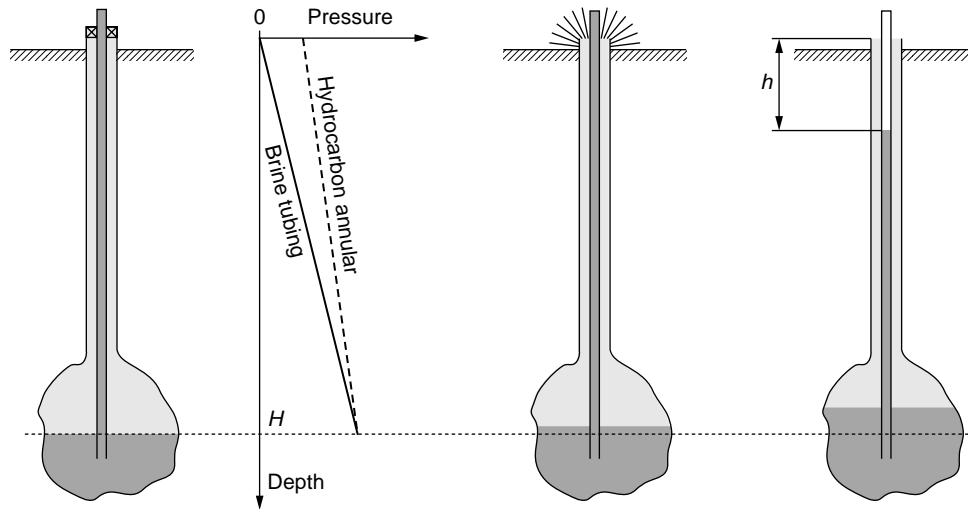

Figure 3

Scenario of a blow out. When the valve fails at ground level, liquid is expelled until a new equilibrium is reached; air/brine interface in the central tubing drops by h .

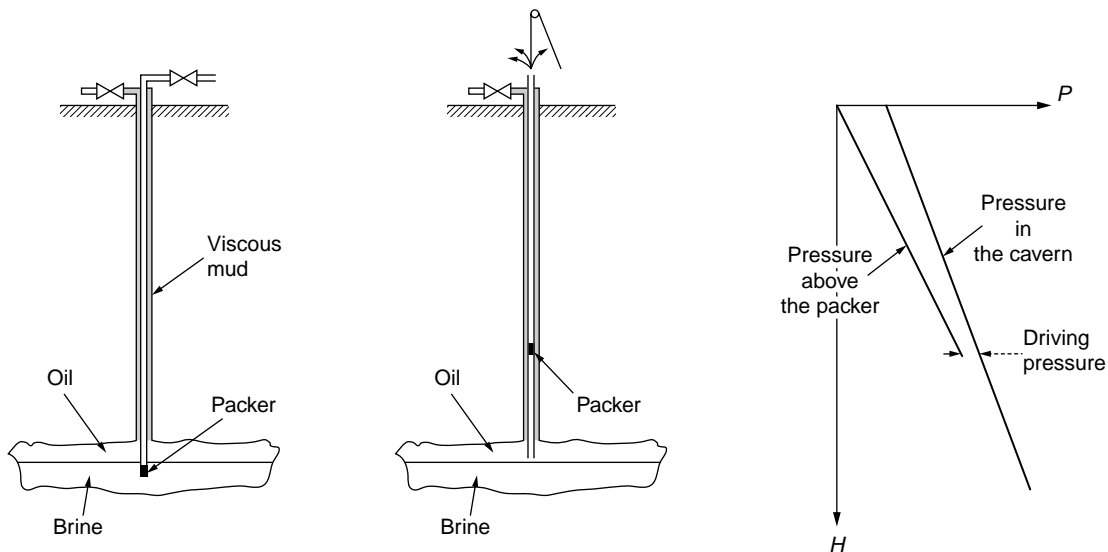

Figure 4

West-Hackberry blow out. A packer is set at the bottom of the tubing. The pressure differential applied to the packer increases when the tubing is pulled up. The packer slips, leading to larger differential as the packer slides upward.

evaporate gradually after rushing over the ground, and a heavier-than-air gas cloud would form. Ignition of the cloud is likely.

1.2.2 Accident at the West Hackberry Facility (Louisiana)

Accident Description

The West Hackberry salt dome is located near the Mexican Gulf in southern Louisiana. In 1977, the *US Department of*

Energy (DOE) acquired a number of cavities that had provided brine for the chemical industry. These cavities now are used as a part of the Federal Program for a Strategic Reserve of crude oil, or SPR (Furiga and Smith, 1983). The total capacity of the site is 50 Mbbbl (8 Mm³).

A complete description of the accident that occurred at West Hackberry can be found in *DOE* (1980). Additional information has been made available to the authors by *DOE*.

The accident occurred on September 21, 1978, during operation on one of the wells in the no. 6 cavity. (This large cavity has several wells, allowing reasonably quick withdrawals.) Understanding the causes requires a few comments on the well completion. Completion comprises a 12.75-in (32.4 cm) casing cemented to a depth of 2632 ft (816 m). A 9.62-in (24.4 cm) pipe, 2603 ft (807 m) long, is cemented inside. (The pipe was probably added after the “initial” completion to improve oil tightness when the brine production cavity was being converted for storage.) A 5.5-in (14 cm) pipe had been used to withdraw the brine when oil was pumped in (*see Fig. 4*). The DOE report states that the work on the well consisted of withdrawing the 5.5-in tube, repairing a leak on the 12.75-in casing, and reinforcing the wellhead equipment.

In order to withdraw the 5.5-in pipe, the annular space between it and the 9.62-in pipe had been filled with high-viscosity mud to bring the pressure at the wellhead to zero. Then, a packer was set at the bottom of the 5.5-in pipe to seal it off from the cavity. Work commenced on pulling the 5.5-in pipe; however, after 14 lengths had been removed, the packer slipped, and the oil pushed it up to the surface. As the packer moved upward, the pressure differential on it increased. The packer then shot up to the surface, and the oil geyser continued until all the pressure was dissipated.

An estimated volume of 72 000 bbl of oil (10 000 m³) shot up into the air and caught fire, killing one man in the drilling crew. The above-mentioned report contains a detailed description of the steps taken to combat the resulting pollution. The DOE report estimates the total cost of the accident at between (1980) US\$14 M and \$20 M.

Tentative Analysis of the Accident

The accident at West Hackberry shows that the highest risks do not result from normal operation of the facility but, rather, from special operations.

In analyzing the accident, we must look beyond the moment of failure of the packer. The basic cause was the delicate operation that was undertaken while the oil was under high pressure and liable to expand violently if any mishap occurred. Although injecting the viscous mud in the annular space was a good precaution against any failure of the topside valve on the oil-filled annular space, it had no effect on the dangerous situation at the bottom of the cavity.

A more comprehensive precaution could be taken by releasing the pressure on the oil so that the pressure at the top of the annular space is removed. This would cause the air/brine interface in the central tubing to drop by about one-quarter of the total height (*see Fig. 3*). The volume removed would, of course, be exactly equal to the volume that would be expelled in an accident. As well head oil pressure is zero, no blow out can take place.

1.2.3 A Liquid Propane Storage-Well Fire

The accident happened in a two-cavern propane storage terminal and, along with the capping and kill plan, is described in Gebhardt *et al.* (2001). These authors point out that “LPG storage (or cavern) wells rarely blow out and/or catch on fire” (p. 302). The cavern in which the blow-out occurred extended from 1200 to 2500 ft (360 to 750 m). It was believed that the two caverns communicated, due to earlier work in another storage well that led to salt fracturing. At the time of the accident, a “work-over” (Gebhardt *et al.*, 2001, p. 303; in fact, this was probably a Mechanical Integrity Test, or MIT) was performed on the second cavern. Nitrogen was used, inducing a large pressure build-up in the two caverns. The wells originally were drilled as oil producers in the late 1950s, four decades before the accident, and a casing leak at shallow depth resulted from the pressure build-up.

Liquefied gas escaped through the soil in an area as far as 100 ft (30 m) from the well. The gas ignited and burned with a heavy black smoke. Extinction of the fire was not a viable option, as dangerous re-ignition was likely. The kill operation used the innovative techniques described in Gebhardt *et al.* (2001).

1.2.4 Overfilling at Brenham (Texas)

In storing liquid/liquefied products, underestimating the location of the brine/hydrocarbon interface in the cavern can lead to hydrocarbon access into the brine-filled tubing, with dramatic consequences if the shut-down emergency system at the well-head happens to be defective. Such an accident occurred in Brenham, Texas, in 1992 (*Fig. 5*). Earlier similar events at two other sites are reported by the *National Transportation Safety Board (NTSB, 1993)*, although these did not cause serious damage. This report provided a full account of the Brenham overfilling accident and was used for writing the following brief account.

The Brenham storage facility consists of a 380 000 bbl (60 000 m³) cavern filled with LPG (actually, a mixture of propane, ethane, *n*-butane and other gases). The cavern is linked to ground level by a 13-3/8-in (34 cm), 2702 ft (810 m) long cemented casing (*Fig. 6*). A tubing (2871 ft, or 860 m long) allows injection/withdrawal of brine. LPG is injected to or withdrawn from three distinct pipelines. Brine is provided by two above-ground brine ponds. The wellhead is equipped with a shut-down valve. The Brenham station is operated remotely by a dispatcher in Tulsa, Oklahoma.

At 5:43 a.m. on April 7, 1992, LPG was injected in the cavern. The brine/LPG interface unexpectedly reached the 1-in (2.5 cm) diameter weep hole located in the lower part of the tubing, 1 ft (30 cm) above the tubing base (*Fig. 6*). The weep hole is supposed to provide warning in case of imminent overfilling. LPG flew into the tubing, leading to lower density in the fluid central column, partial



Figure 5
Brenham burn area (after NTSB).

vaporization, expansion of the lighter gases, a pressure drop in the cavern and, ultimately, a larger flow of gas through the weep hole and the tubing base alike. Brine, followed by liquefied gas, erupted at the brine pond surface. Back-calculation proved that 3000 to 10 000 bbl (500 to 1 600 m³) of liquefied gases were expelled.

The release of gas in the atmosphere activated gas detectors at ground level. (Such activation was a relatively frequent event at this station, often unrelated to an actual gas leak.) The dispatcher in Tulsa was not able to interpret correctly the somewhat confusing information delivered by the telemetric system—a unique signal was sent, whatever the number of activated detectors. The shut-down valve (or cavern safety valve) was assumed to react immediately to high pressure levels (100 psi, or 0.7 MPa) in the brine tubing at the wellhead, but the system failed.

A heavier-than-air gas cloud, probably 30 ft (10 m) high, developed above the station. Employees blocked routes to prevent access to the station. At 7:08 a.m., a car entered the foggy cloud and ignited the gas, resulting in a severe explosion (readings of 3.5 to 4 were recorded on the Richter scale), and three people died from injuries received (Fig. 5).

Post-accident analysis (NTSB, 1993) identified several causes for the accident:

- Underestimation of the amount of stored LPG (330 000 bbl, or 52 500 m³, were actually stored, instead of 288 000 bbl, or 45 800 m³, estimated) due to metering inaccuracy, inability to balance gas input/ output, poor knowledge of

Schematic diagram of an highly volatile liquid (HVL) storage operation in salt dome

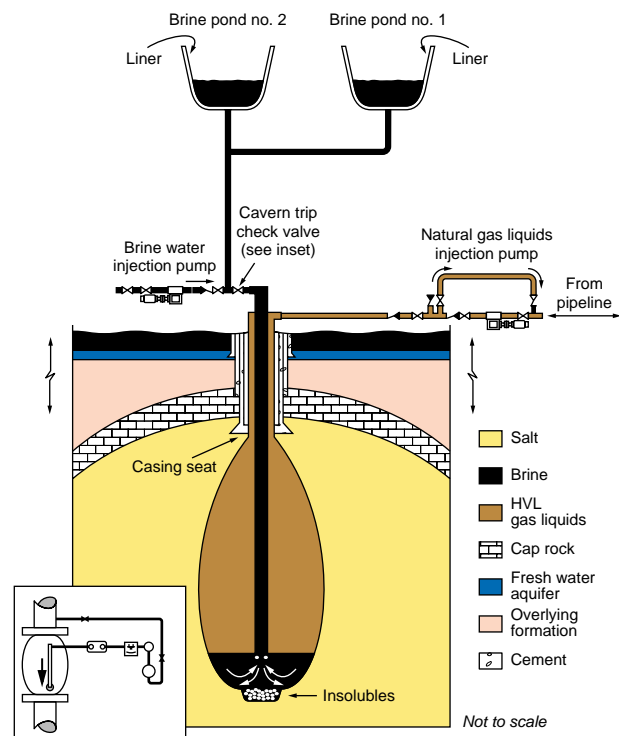

Figure 6
Brenham cavern (after NTSB, 1993).

LPG density in the column, employee miscalculations (furthermore, pond saturated-brine had been sold to drillers, leading to injection of undersaturated brine and additional dissolution—cavity volume had increased by a factor of 9 from 1981 to 1991), and inadequate location of the weep hole, leading to late overfilling warning. The distance between the tubing base and the weep hole was made 6 ft (1.8 m) in the later re-design of the facility, instead of 1 ft (0.3 m) in the 1992 configuration.

- Insufficiently detailed information transmitted to the dispatcher board.
- Failure of the emergency shut-down system valve. This system included a brine pressure-sensing line; large pressure build-up in the line switched a spring that, when triggered, sent an electrical signal in a chain containing a fusible link whose fusion closed the safety valve. It is extremely likely than one or two manual valves were closed on the sensing line, isolating it from main body of the brine tube and making the emergency system ineffective.

In sour irony, one of the consequences of the gas ignition was that the shut-down valve was activated when heat from the explosion burned the fuse.

After this accident, the *Railroad Commission of Texas* promulgated new regulations (effective in 1994) mandating that LPG storage caverns be protected by **two** overfill detection and automatic shut-in methods. A group discussion on cavern overfill detection was conducted by SMRI during its 1996 Spring Meeting (Thiel, 1996).

1.2.5 Natural Gas

For natural-gas storage, little brine is left at the bottom of the cavern, and brine movement is not managed when injecting or withdrawing gas. Gas pressure builds up when gas is injected and drops when gas is withdrawn. In case of wellhead failure, the gas volume of the full cavern would be expelled. This phenomenon probably would be spread over several weeks, depending upon the initial gas pressure and head losses through the well. The eruption would be most spectacular, but probably less dangerous than an LPG eruption, because natural gas is significantly less dense than air. The gas cloud would move upward rapidly and disperse in the higher atmosphere. In some cases, the cloud could kindle at an early stage, but, if it does not, the risk of explosion would be small. A case story is described in the next section.

Rapid depressurization of the cavern, one consequence of well-head failure, can lead to severe stress build-up at the cavern wall. An estimation of this effect can be found in Rokahr and Staudtmeister (1993) and Wallner and Eickemeier (2001).

1.2.6 The Fort-Saskatchewan Accident

On August 26, 2001, at approximately 8 a.m., an uncontrolled release of ethane occurred in the *BP Canada*

facility operated at Fort-Saskatchewan, Alberta. An ethane leak developed in a horizontal pipe linking the two well-heads of cavern 103, an ethane storage cavity equipped with a product well and a brine well. The ethane caught fire at 9:40 a.m. Fire-control experts sprayed water to cool down the two well-heads. Cavern pressure dropped as the cavity slowly emptied. On September 1, the small remaining fire on the brine well was outfitted with a new master valve. On September 4, a plug was set down hole in the second well, and the emergency was declared over.

The accident developed above ground and is of minor interest from a geotechnical perspective, but the situation clearly was made more difficult to handle by the large ethane volume that filled the underground cavern. Crisis management was effective and included an information center, a 24-hour emergency line, daily media briefings and individualized meetings with the residents. Updated information was made available at the www.ngl.com web site, which provided the data used in this paper, and an additional oral presentation was given during a SMRI Meeting (Banff Spring Meeting, 2002), in compliance with the company policy “to share the findings with the industry in the interest of safety.”

2 STORAGE TIGHTNESS

2.1 Introduction

Tightness is a fundamental prerequisite for many underground works where minimum product leakage is required. The goal of tightness has no absolute nature; rather, it depends upon the specific sensitivity of the environment and the economic context. Air, natural gas, butane and propane are not poisonous from the perspective of underground-water protection: the leakage of sufficiently diluted natural gas into underground water has minor consequences for water quality. This does not apply to other products, such as crude oil.

From the perspective of ground-surface protection, the most significant risk is the accumulation of flammable gas near the surface. In this situation, gases that are heavier than air (propane, ethylene, propylene) are more dangerous than natural gas, but a recent accident in Hutchinson, Kansas, proved that the accumulation of natural gas in shallow water-bearing formations can lead to severe consequences.

The economic perspective depends basically on the speed of stock rotation and the nature of the products stored. For example, when storing compressed air to absorb daily excess electric power, a loss of 1% per day is considered to be reasonable. When storing oil for strategic reasons (*e.g.*, oil that will be used only during a crisis), the loss must be smaller than 1% per year.

2.2 Factors Contributing to the Prevention of Leakage in Salt Caverns

Three main factors contribute to the problem of leakage in wells:

- pressure distribution of the various fluids;
- geological environment;
- cementing workmanship and well architecture.

The influence of these three factors is discussed in Bérest *et al.* (2001b). In this paper, we focus on case histories.

2.3 Mont Belvieu Accident

2.3.1 The Accident

This accident occurred in 1980 at Mont Belvieu, Texas, where a salt dome is used by a large number of companies and where several dozen cavities had been solution-mined (a map is shown on *Fig. 13*). This site has the largest storage capacity for petrochemical products anywhere in the United States.

A drop in pressure was recorded on September 17, 1980, in one of the cavities containing liquefied petroleum gas. On October 3, gas (70% ethane, 30% propane) that had accumulated in the foundation of a house in the area exploded as a result of a spark from an electrical appliance. The cavity in which the pressure had dropped was then filled with brine. In the days that followed, gas appeared haphazardly around the area, and approximately 50 families had to be evacuated. Holes were drilled into the water tables above the salt to find and vent the gas.

In the absence of fully detailed information, we make a credible reconstruction of the accident based on a typical propane storage facility in a salt dome.

2.3.2 Analysis of the Accident

A salt dome is a geological structure in which an originally horizontal bed of salt has risen toward the surface by puncturing the overlying strata. When the dome reaches water-bearing layers, the top may dissolve, leaving a cap of insoluble rock surrounded by brine (*Fig. 7*).

If the well casing is leaky (*e.g.*, at a joint between two lengths or because of corrosion; the well “at fault” at Mont Belvieu dated from 1958), the product can escape toward the caprock. Leakage is faster when there is a high pressure differential between the product and the groundwater. The differential may be significant if the caprock lies much higher than the storage cavity.

Because of its low density, propane tends to rise to the surface, either through the cement along the outside of the casing or by dispersing in the overlying ground. This happens, for example, if it finds a sufficiently pervious water-bearing layer just below the surface. The gas can accumulate in building foundations, emerge at streams and similar low-lying ground or come up through faults and joints, daylighting at the surface several hundred meters from the well head.

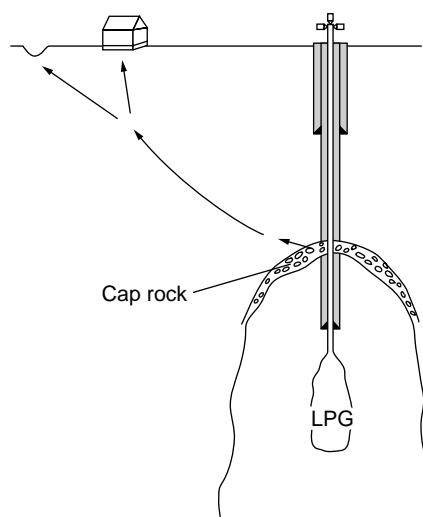

Figure 7

The Mont Belvieu (Texas) accident. After 22 years of operation, the last cemented casing became leaky. In Texas, recent wells are equipped with two casing strings into the salt.

The architecture of the well is here of utmost importance. Had the two last cemented casing been anchored in the salt formation (Thoms and Kiddoo, 1998), the leak would have been channeled in the cemented annular space between the two casings, with considerably smaller consequences.

2.3.3 Regulations in Texas

The *Railroad Commission of Texas* established Rule 74, effective April 1, 1982, which specified cavern integrity testing requirements (Johnson and Seni, 2001). In 1993, the Commission decreed that future wells be equipped with two casing strings cemented into the salt (*Texas Railroad Commission, TAC Title 16 Part 1 § 3.95 and 3.97*). Integrity tests are discussed below.

2.4 The Hutchinson Accident

To prepare the following brief account, the authors used articles from the following: *Geotimes* (Allison, 2001), *Gas Utility Manager* (April 2001), and the local press (*The Hutchinson News*, Wilson, 2002; *The Kansas City Star*, *KSN Station Homepage*, *Newton Kansas Online News Digest*, 2001). A large amount of information was provided in the days following the accident by SMRI through its web site—clear illustration of the benefits of new information tools. The authors were provided with valuable insight by Joe Ratigan, an underground storage expert who worked on the case⁽¹⁾.

¹ The authors take full responsibility for any misinterpretation or incorrect reporting of the facts.

2.4.1 The Accident

On January 17, 2001, at 10:45 a.m., a sudden release of natural gas burst from the ground under a store and a neighboring shop in downtown Hutchinson (Kansas), shattering dozens of store windows. Within minutes, the two businesses were ablaze (Fig. 8).

In the afternoon of the same day, 8 (some reports say 9) brine and natural-gas geysers began bubbling up, 2 to 3 miles east of the downtown fire, some reaching 30 ft (10 m) high, and two geysers ignited. The fluids were suspected to have migrated from the underground through abandoned brine wells that had been drilled as long ago as 1880. Indeed, under the store location where the first burst-out took place, a former hotel spa used to pump out hot brine from a 740 ft (235 m) deep well. The next day, natural gas coming up from such a long-forgotten brine well exploded under a mobile home, killing two people.

On January 17, eight miles northwest of downtown Hutchinson, technicians from the Yaggi natural-gas storage recorded a 100 psi (0.7 MPa) gas pressure drop in the S-1 salt cavern. It is believed that the pressure drop took place 15 min after the first downtown blast. The cavern had been refilled 3 days earlier.

The underground storage had been developed in the 1980s to hold propane. Caverns had been leached out at a depth of 650-900 ft (the S-1 casing shoe is 794 ft or 239 m below ground level) in the lower parts of the Permian Hutchinson Salt Member of the Wellington formation (*see Fig. 9*). It seems that the field had frequent propane leaks. The owner became bankrupt, and the site was closed in the late 1980s. Wells were cased into the salt and later plugged by partially filling them with concrete. The site was acquired by a new company in the early 1990s and converted to a natural gas storage. By 2001, 60 to 70 caverns were active, with a global storage volume of $3.5 \cdot 10^9$ cu ft (or 10^8 Nm³; the volume considered here is the volume under atmospheric pressure) at pressures of about 600 psi (4.2 MPa)— $6 \cdot 10^7$ cu ft for the S-1 cavern that experienced a dramatic pressure drop on the morning of January 17.

A gas leak through the S-1 cavern casing was rapidly incriminated, and the well was plugged below the leaky level on January 24.

This pressure drop was reported to Hutchinson officials on January 18; a link between the pressure drop and the downtown events was suspected immediately, even though the distance between the storage and the downtown springs (7-8 miles, or 10 km) set a puzzling geological problem.



Figure 8

Fire in a Hutchinson store and gas vent (after Kansas Geological Survey Web Site).

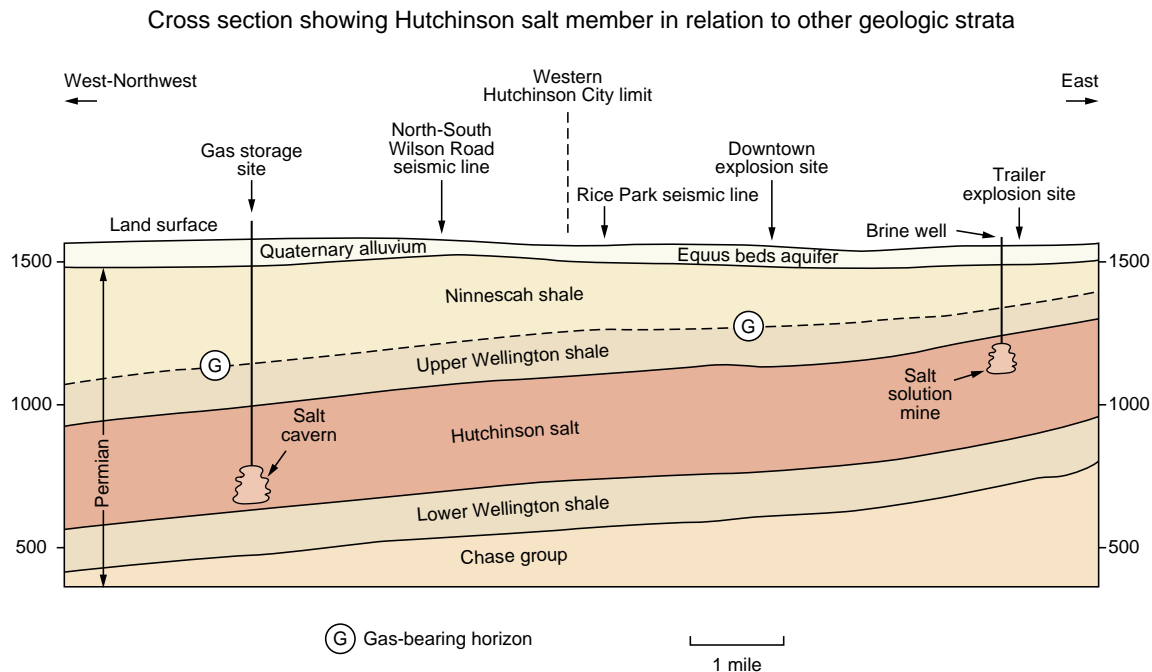

Figure 9

Hutchinson leak pathway. Quaternary alluviums are composed of sands and gravels, 50 ft thick. Below are the Permian Ninescah shale, the Upper Wellington shale and the Hutchinson Salt member. The gas-bearing interval ranges from 270 ft deep in the east side of the city to 400 ft deep several miles north-west of the city; the dip is 20 ft per mile and includes interbedded layers of shale, gypsum and dolomite. Gas probably is transmitted through fractured dolomite layers (Kansas Geological Survey, 2001).

A down-hole video performed on January 24 in the S-1 well showed a large curved slice in the casing at a depth of about 585 ft (180 m). It was suspected that the gas moved vertically up the outside of the casing to a nearly horizontal gypsiferous/dolomitic zone updipping toward Hutchinson and then spread horizontally, the gas remaining trapped between two impermeable shale layers. The gas made its way to Hutchinson, where it found abandoned brine wells, most of them only cased down to a shallow aquifer.

The storage owner began to drill wells to vent gas to the surface in the Hutchinson area (Fig. 8). In fact, of the first 36 wells drilled in and around Hutchinson, only 8 hit gas (Allison, 2001), clear evidence of the complex pattern of underground pathways. A high-resolution seismic reflection survey was performed between the city and the Yaggi field by the Kansas Geological Survey. Two anomalous zones, 150 ft (45 m) and 200 ft (60 m) wide, respectively, were identified (Allison, 2001). The Kansas Geological Survey drilled seismic anomalies and found gas. However, a core hole drilled a few tens of feet of one of the gas-producing wells found tight dolomite layers and no gas. Examination of gamma-ray logs from the gas-producing wells led to a

revised theory: gas pathways were composed of fractured zones in the gypsiferous/dolomitic layers that pinched out north-west against the tight shales (Allison, 2001). Gas from the Yaggi site had moved updip (see Figs. 9 and 10) through the possibly fractured dolomites. By mid-March, gas flow rates and pressures in the vent wells continued to decline.

2.4.2 Analysis of the Accident

A tentative explanation of the accident can be formulated, though it will probably be revised, as data are still incomplete. The S-1 cavern belongs to a 16-cavern cluster (4 rows of 4 caverns). The well heads of the 16 caverns are linked by a manifold, and the cavern pressures are recorded during normal operations through a unique pressure gauge, making leak detection even more improbable than were the gas pressures measured in each individual cavern.

The S-1 cavern was probably leaky from the beginning (*i.e.*, when the abandoned wells were redrilled for further use in 1993). When workers removed cement and cast-iron plugs, extensive milling took place in the 9-in (23 cm) casing of the S-1 cavern at about the depth (595 ft or 179 m) of the later leak. It is suspected that a 50 lb (25 kg) tool (quick

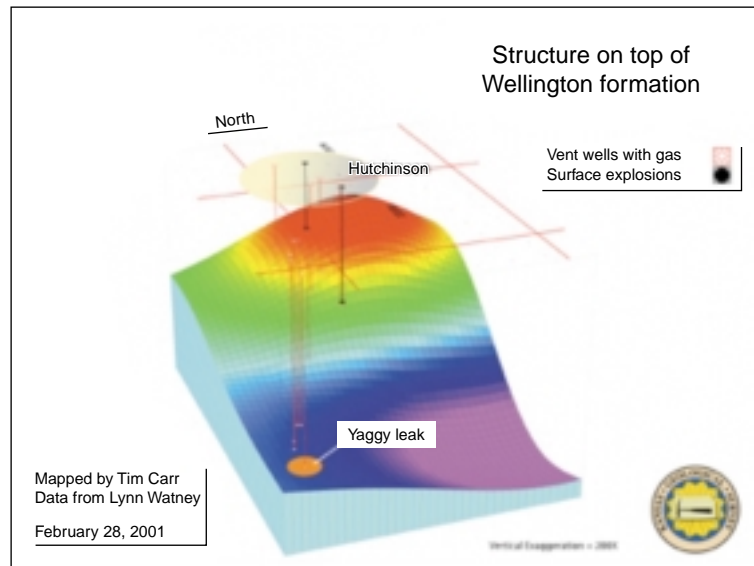

Figure 10

Hutchinson leak, top of the Wellington formation (Kansas Geological Survey, 2001). Gas migrates updip from Yaggy to Hutchinson, where it finds an easy route to ground level through old abandoned wells.

coupler) and other metal objects had been dropped down the well when the former storage was abandoned. Re-drilling operations lasted from November 1992 to August 1993, a very long period of time for such a relatively simple operation. In principle, the leak could have been detected during the MIT leak test performed before recommissioning of the cavern. However:

- at that time, the leak had probably not yet fully developed its pathway to above-laying layers. (It must be kept in mind that, generally speaking, the surrounding rock formations are impermeable.);
- liquid leak tests (*see Section 2.5*) were performed before commissioning at a 0.75 psi/ft ($1.73 \cdot 10^{-2}$ MPa/m) gradient. However, S-1 was the last well to be tested, and no more saturated brine was available at that time: the well was filled with soft water prior to testing, resulting in a 0.64 psi/ft ($1.48 \cdot 10^{-2}$ MPa/m) testing gradient.

The leak probably began to develop at that time—*i.e.*, 8 years before the accident took place. The gas found an upward route through the cementation to the fractured dolomite level and slowly spread to the underground of Hutchinson, 8 miles from the storage site, through a few fractured channels. (Remember that only a few venting wells hit the gas.) The maximum gas pressure in the cavern was 590 psi (4.1 MPa) before 1997, but the average gas pressure for a long period of time was smaller due to periodic injection/withdrawal of gas. Taking into account head losses, gas pressure below the city was probably small enough (water table is 60-80 ft below ground level) to prevent any blow out through the numerous wells tapped in the city

underground and filled with brine and/or soft water. After 1997, a 17.5% maximum pressure increase was authorized by the state, raising the maximum pressure to 693 psi (4.78 MPa). (The casing shoe depth is 794 ft or 238 m.) Gas was injected at the beginning of 2001, and the gas pressure jumped from 426 psi (2.9 MPa) on January 2001 to 691 psi (4.76 MPa) at 6 a.m. on January 14. The pressure gradient was then 1.18 psi/ft at leak depth on Sunday, January 14—probably larger than overburden pressure. The pressure began to drop at the well head, a move that can be interpreted from hindsight as a clear sign of increasing leak rate. An additional 80 Mcu ft ($2.3 \cdot 10^6$ m³) of natural gas was injected on Monday and Tuesday. It has been calculated that, as a whole, the perforated well spewed as much as 143 Mcu ft ($4.0 \cdot 10^6$ m³) of gas into the surrounding formation during this period. The pressure build-up spread throughout the gas-filled fractured channels, ultimately reaching hydrostatic value under Hutchinson. Gas blow-out then burst through the city. Clear evidence of the existence of multiple independent channels is suggested by the occurrence of a dozen geysers during the 24-hour period following the first blow-out. The geysers progressively vented the accumulation of gas under the city, leading to no further gas eruption.

After the accident, poor regulation and the small inspection staff in the state of Kansas (compared to neighboring states) were incriminated by several experts. New set of regulations are currently discussed (Johnson, 2002). They include mandatory double casing in wells, corrosion control, well conversion restrictions (salt caverns designed to store LPG could not be converted to store natural

gas, and cavern wells that have been plugged cannot be reopened and used again), maximum pressure limit of 0.76 psi/ft ($1.73 \cdot 10^{-2}$ MPa/m) and new testing requirements (a leak test should be performed every 5 years).

2.5 Tightness Testing

Tightness can be tested through MIT. Two types of MIT are currently used:

- The Nitrogen Leak Test consists of lowering a nitrogen column in the annular space below the last cemented casing. The central string is filled with brine, and a logging tool is used to measure the brine/nitrogen interface location in the annular space. Two or three measurements, generally separated by 24 h, are performed; an upward movement of the interface is deemed to indicate a nitrogen leak. In several states such a test must be performed every 5 years in LPG caverns. Crotogino (1995) suggests that the Maximum Admissible Leak Rate during such a test be 150 kg of nitrogen per day; see also Thiel (1993).
- The Liquid Leak Test consists of pressurizing the fluid-filled cavern. During the test, attention is paid to the evolution of fluid pressures as measured at the well head; too fast a pressure drop is a clear sign of poor tightness. This testing method is simpler, but probably less demanding from the perspective of checking tightness.

Additional comments and references can be found in Bérest *et al.*, 2001b.

3 CAVERN STABILITY

3.1 Case Studies

All solution-mined cavities converge as they gradually, and quite slowly, shrink. Prediction of volume loss rate has led to numerous works, but it is still a controversial matter. A brief discussion of the various theoretical approaches is provided at the end of this chapter, but a few facts are presented here.

- Subsidence is experienced at several sites (*Figs. 11, 12, 13*)—see, for example, Menzel and Schreiner (1983), Ratigan (1991), Durup (1991), and Van Sambeek (1993). However, no damage at ground level resulting from cavern convergence has been experienced, as the subsidence bowl slope is small (*see Figs. 11 and 12*). Nguyen Minh *et al.* (1993) and Quintanhila de Menezes and Nguyen Minh (1996) proved that, at the Tersanne site, where cavern convergence is relatively large, the volume of the subsidence trough at ground level was 60% of the estimated volume loss of the cavities after 6 years of operation. In this 1400 m deep bedded salt formation, the subsidence rate was approximately 1 cm/year.

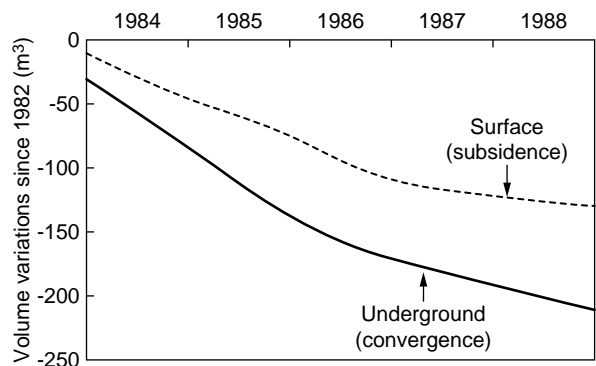
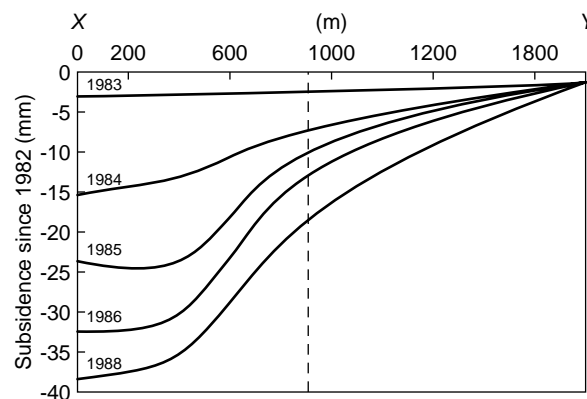
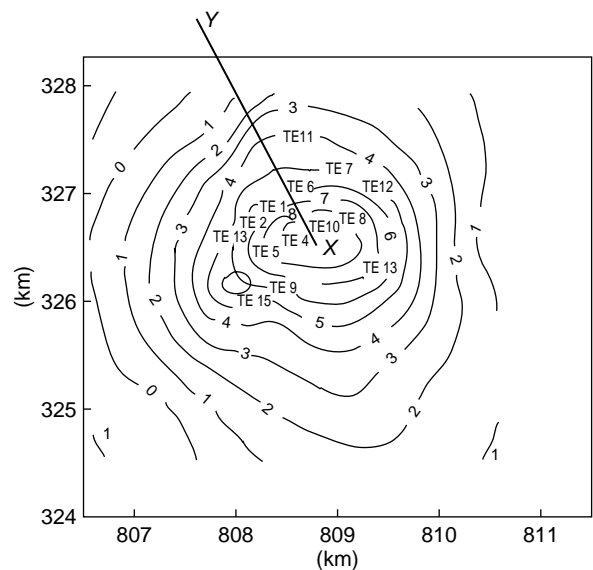

Figure 11

Subsidence in the Tersanne site (after Durup, 1991).
Subsidence trough volume is 60% of caverns volume loss.

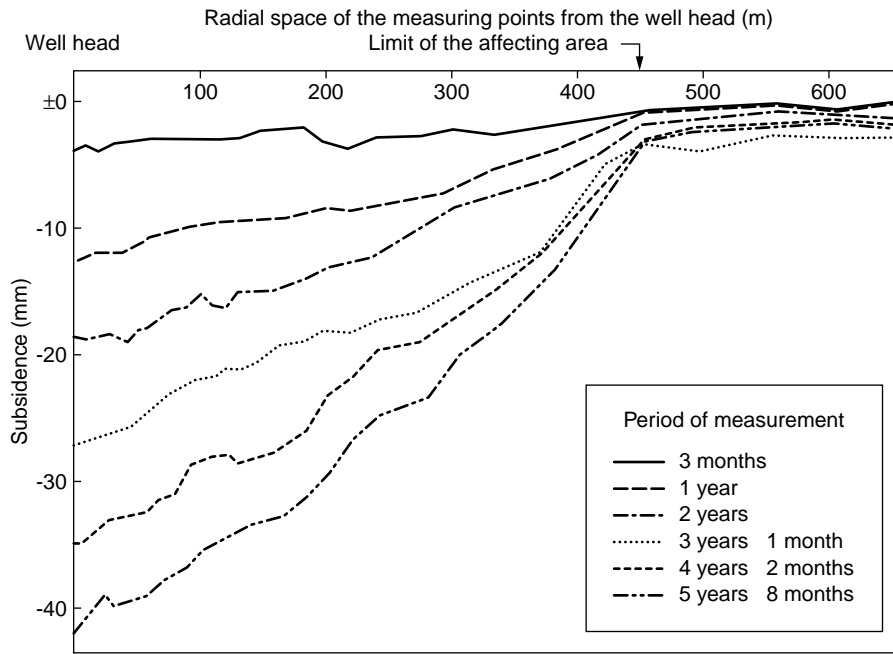

Figure 12

Subsidence in the Bernburg (Germany) site (after Menzel and Schreiner, 1983). There are several caverns in this site. Caverns depths are 500-650 m; the useful volumes of the caverns are 1-3 10⁵ m³.

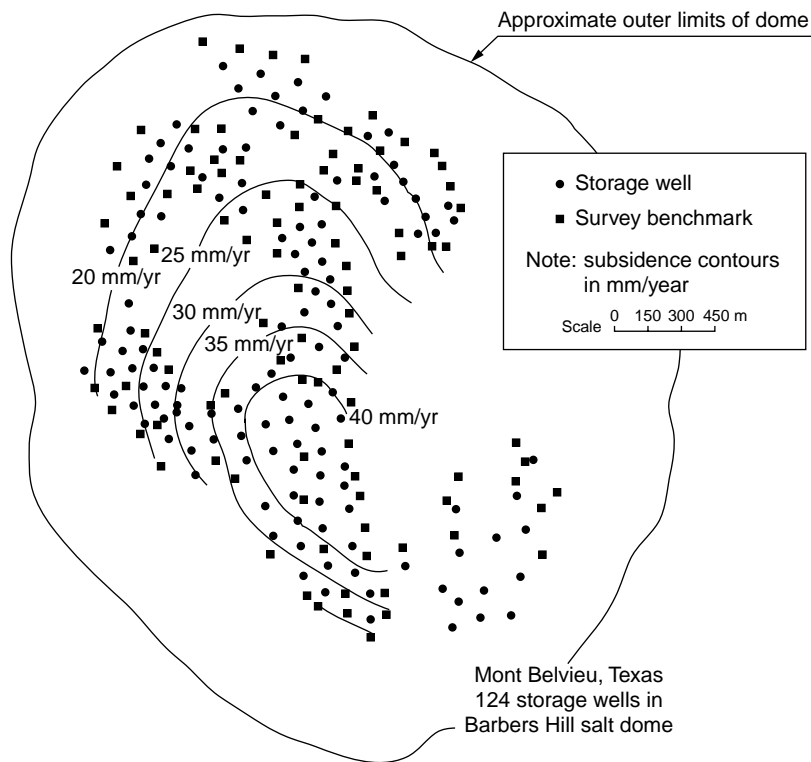

Figure 13

Subsidence in the Mont Belvieu (Texas) site (after Ratigan, 1991). At this site, 124 caverns were operated in 1991.

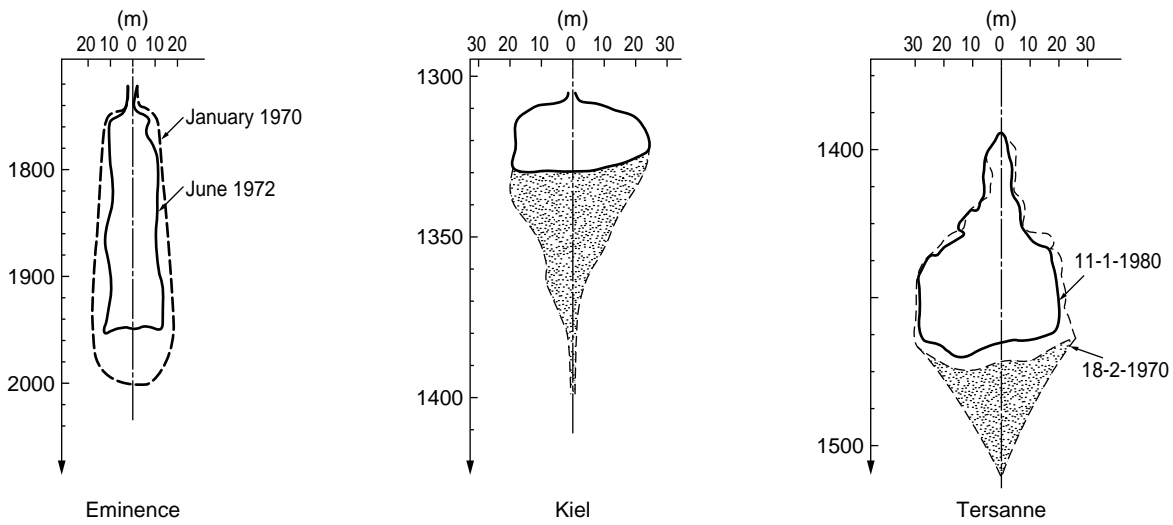

Figure 14

Creep effects in Eminence (Mississippi), Kiel (Germany) and Tersanne (France). The dotted surfaces represent insolubles sedimented at the cavern bottom. Volume losses for the Kiel cavern are not represented.

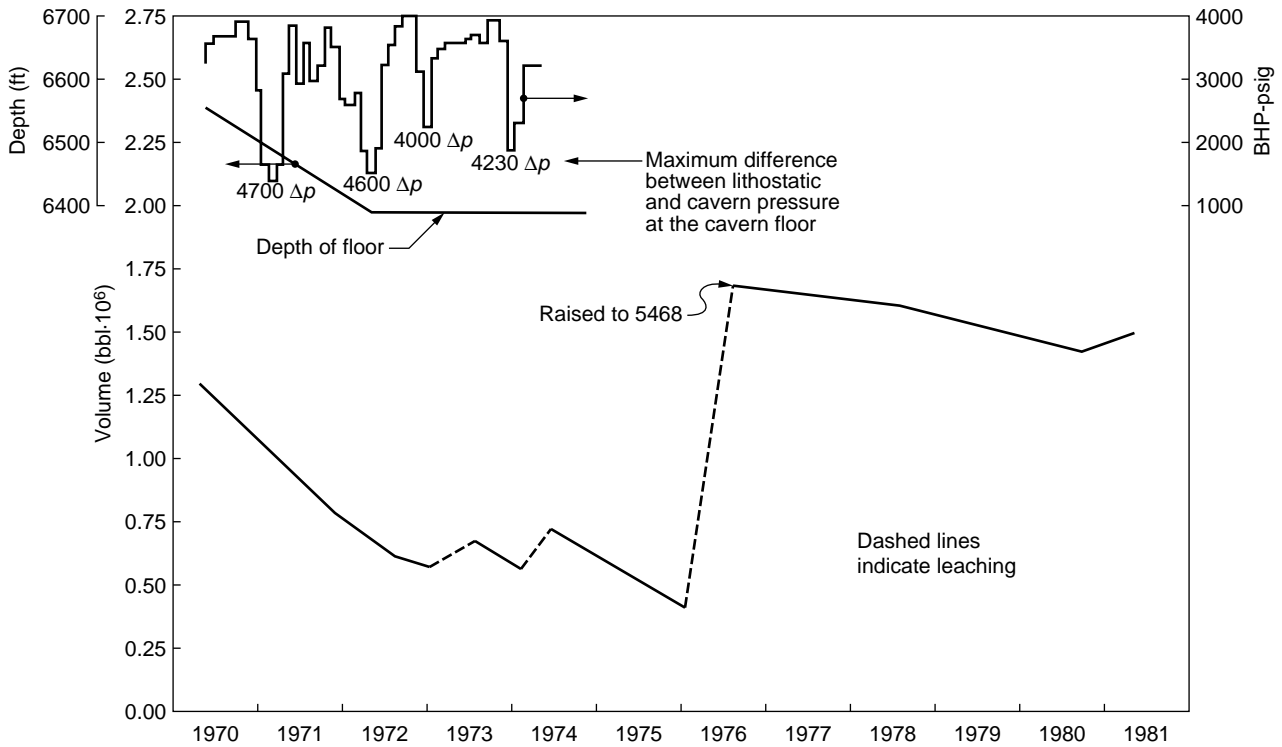

Figure 15

Volume and pressure as functions of time for Eminence cavern no. 1 (after Coates *et al.*, 1983; original source is Fenix and Scisson, 1980).

- Convergence rates in shallow, fluid-filled caverns are slow. Brouard (1998) measured brine outflow from the cavern well head in a brine-filled, 950 m deep, $7500 \pm 500 \text{ m}^3$ cavern at the Etrez site. The test was performed 15 years after cavern leaching: in this small cavern, the effects of brine thermal expansion become negligible after such a length of time; the 7.2 l/day brine outflow can be attributed to cavern convergence. The relative volume loss rate was $\dot{V}/V = -3 \cdot 10^{-4} \text{ year}^{-1}$, a very small figure.
- Some natural gas storage facilities have experienced large losses of volume. The Eminence salt-dome caverns (Mississippi) have experienced large changes after a relatively short period of time. According to Baar (1977, p. 143-144): “the unexpected anomalies in the closure of the first cavern included a rise of the cavity bottom by 120 ft (36 m) and a cavity storage space loss possibly up to 40%.” According to Baar (1977), cavern 1 was leached out on December 21, 1969, and dewatering was finished on October 8, 1970. On May 25, 1970, the cavity bottom was at a depth of 6560 ft (2000 m), and the cavity top was at 5750 ft (1725 m). After dewatering, the gas pressure was reduced to 1000 psi (7 MPa) and kept at this value for more than 2 months, after which it was built up to about 4000 psi (28 MPa). Then, a second pressure cycle began; after the second cycle, on April 28, 1972, the “cavity bottom was at 6408 ft (1953 m), which means a loss of 152 ft (46 m) in about two years.” On June 23, 1972, the “cavity had been refilled with brine and a sonar was taken after refilling” (Figs. 14 and 15). Additional information is provided in Coates *et al.* (1983). Bérest *et al.* (1986) suggested that the asymmetrical deformation of this cavern (*i.e.*, large bottom upheaval and

small roof displacement) was due to the higher temperature and the higher overburden pressure at the bottom than at the top of this slender cavern.

- Röhr (1974) provides some data related to the gas-storage cavern Kiel 101. This cavern had been leached out between the depths of 1305 m and 1400 m (Fig. 14). Due to the high content of insolubles, less than 60% of the total $68\,000 \text{ m}^3$ was available for storage. “Starting about 1 November 1967, the pressure at the roof of the cavity was lowered from 15.6 MPa to practically zero by pumping the brine out of the access well” (Baar, 1977, p. 147). Figure 16, presented by Baar (1977), shows the internal pressure at the roof of the cavern dropping from 13.1 MPa to 6.5 MPa in 5 days (the roof broke at this stage), then building up (when pumping stops, large cavern convergence rates lead to rapid brine-level rise in the well, resulting in cavern pressure build up and slower convergence rates, as observed on Figure 16) to 8 MPa during a 35-day period. A sonar log performed at the end of this period proved that the sonar volume had decreased from $36\,600 \text{ m}^3$ to $32\,100 \text{ m}^3$. An additional loss of 1900 m^3 in usable cavern volume was observed 5 months later.
- Boucly and Legreneur (1980) and Boucly (1984) provide data on Te02, a gas-storage cavern at the Tersanne site (*see Fig. 11*) in southeastern France. This pear-shaped cavern was leached out from November 1968 to February 1970; dewatering took place from May to September 1970. The initial usable volume at that time was $91\,000 \pm 2700 \text{ m}^3$, and the additional volume of sedimented insolubles was $22\,000 \text{ m}^3$. From September 1970 to July 1979, the mean pressure in the cavity remained comparatively high (18 MPa), but pressure variations

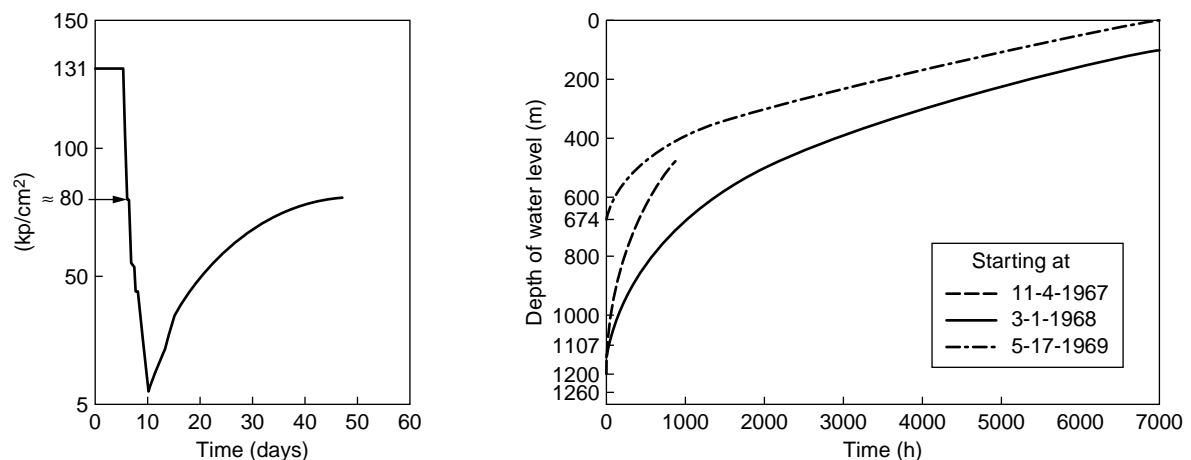

Figure 16

Internal pressure at the roof of the Kiel 101 cavern during dewatering of the access well in November 1967 and the brine-level rise in the well after brine level was lowered at the indicated times (after Baar (1977); original sources are Dreyer (1972) and Röhr (1974)). Initial brine level rise is rapid, but leads to slower convergence rates.

were relatively large. Gas pressure (P_i) history is important in this context and can be summarized as follows:

- 8 MPa $\leq P_i \leq$ 10 MPa for a cumulated period of 163 days;
- 10 MPa $\leq P_i \leq$ 15 MPa for 556 days;
- 15 MPa $\leq P_i \leq$ 20 MPa for 1059 days;
- 20 MPa $\leq P_i \leq$ 22 MPa for 1549 days.

After nine years of operation, the volume available to gas had decreased by about 35% (Fig. 14).

- Smaller convergence rates were observed by Staupendahl and Schmidt (1984) in a 980 m deep cavern kept at atmospheric pressure. The relative horizontal cross-section area loss was 0.5-0.6% per year. Quast and Schmidt (1983) describe a 400 000 m³ slender cavern (1000 m to 1280 m in depth). After 4 years of gas-storage operation during which the cavern pressure varied between 2.5 MPa and 16 MPa, the cavern shape, as measured by sonar logs, had not undergone any substantial changes. (The accuracy of this measurement is a few percent.) An interesting attempt to compare cavern convergences reached after each injection-withdrawal cycle in a gas-cavern of the Epe site was presented by Denzau and Rudolph (1997). *In situ* data can also be found in Cole (2002).

3.2 Temperature and Pressure Influences

At first sight, these data may seem somewhat erratic. However, even if site-specific rock properties play some role, the data infer that the driving force for cavern shrinkage is the gap between the overburden pressure at cavern depth (approximately P_∞ (MPa) = 0.022 H (m), where H is cavern depth) and the cavity internal pressure (P_i (MPa) = 0.012 H (m) in a liquid-filled cavern—significantly less in a nearly empty gas-filled cavern). In fact, for a gas-filled cavern, the entire pressure history (*i.e.*, the durations of the periods during which pressure is high or low) is of importance. Furthermore, laboratory tests prove that salt creep is temperature-sensitive, which means that cavern depth is influential, due both to higher temperatures and higher pressure gaps in deeper caverns. The following simple uniaxial model captures the main features of rock behavior:

$$\dot{\varepsilon} = -A \cdot \exp\left(-\frac{Q}{RT}\right) \cdot \sigma^n \quad (2)$$

where ε is sample height reduction, σ is the stress applied on the lower and upper face of the cylindrical sample, T is the (absolute) rock temperature, and A , Q/RT and n are model parameters. Values of the three constants have been collected by Brouard and Bérest (1998): for twelve different salts, the constant n is in the range $n = 3-6$, illustrating the highly non-linear effect of the applied stress. This model leads to closed-form solutions for spherical or cylindrical caverns, idealized

shapes that give a valuable approximation in the case of many actual caverns:

$$\frac{\dot{V}_{\text{sphere}}}{V_{\text{sphere}}} = -\frac{3}{2} A \cdot \exp\left(-\frac{Q}{RT}\right) \left[\frac{3}{2n} (P_\infty - P_i)\right]^n \quad (3)$$

$$\frac{\dot{V}_{\text{cyl}}}{V_{\text{cyl}}} = \frac{\dot{V}_{\text{sphere}}}{V_{\text{sphere}}} \cdot \left(\frac{2}{\sqrt{3}}\right)^{n+1}$$

These formulae have been given and discussed by Hardy *et al.* (1983) and Van Sambeek (1990). They provide useful orders of magnitude; notably, they clearly explain that the volume loss rate in a fluid-filled cavern is larger by two orders of magnitude when cavern depth is doubled.

However, these simple approximations are poorly suited for gas-filled caverns, where cavern gas pressure varies significantly with time. Model (2) does not capture the transient effects, which play a major role in this context. Vouille *et al.* (1984) and Hugout (1988) have proposed the following Lemaitre or Menzel-Schreiner model, which predicts the evolution of the sample deformation rate during a uniaxial compression test:

$$\dot{\varepsilon} = -K \cdot \sigma^\alpha \cdot t^\beta \quad (2')$$

This model, when generalized to 3D configurations (Durup and Xu, 1996), provides good results when varying pressure is applied to the cavern wall.

The gas-cavern case has motivated various studies, as it is the most demanding from the perspective of mechanical stability: gas caverns are often deep (which allows high gas pressure when the cavern is filled), and they experience very low gas pressure when the cavern is nearly empty. Analyses can be found in Lux and Rokahr (1980), Schmidt and Staudtmeister (1989), Menzel and Schreiner (1989), Krieter *et al.* (1997), Klafki *et al.* (1998), DeVries and Nieland (1999), DeVries *et al.* (2002).

Obviously, rock mechanics problems are not exhausted by the above simple remarks. Several other parameters play important roles, including roof shape (a large-spanned flat roof must be avoided, as it is prone to spalling), distance to the top of the salt formation, spacing between two adjacent caverns, and distance from the dome flanks (which are often the seat of anomalous stresses). Actual geometrical parameters for a wide collection of real cavern sites have been collected by Thoms and Gehle (1988). Many rules have been suggested in the literature, sometimes based on 3D calculation. Expert opinion varies with regard to the stress criterion above which salt can be considered to be damaged. For those interested in the more fundamental aspects of salt rock behavior, a few additional comments are provided below.

3.3 Mechanical Behavior of Salt

The mechanical behavior of salt exhibits a fascinating complexity, and several aspects of it are still open to discussion—see, for instance, the proceedings of the five Conferences on the Mechanical Behavior of Salt (Hardy and Langer, 1984 and 1988; Hardy *et al.*, 1996; Aubertin and Hardy, 1998; Cristescu *et al.*, 2002).

With regard to the behavior of a salt cavern, the situation is somewhat paradoxical. On one hand, a considerable amount of laboratory data is available. (No other rock has given rise to such a comprehensive set of laboratory experiments, motivated, to large extent, by the specific needs of nuclear-waste storage.) Also, various dedicated numerical models, able to accommodate sophisticated constitutive laws and to perform 3D simulations (Guerber and Durup, 1996), have been written. On the other hand, a deep underground cavern is accessible only through the thin metallic tube that links it to the ground surface. Convergence data are rough, scarce, and sometimes inaccurate, and they make validation of sophisticated models uncertain.

Some distinct features of rock salt behavior can be identified: salt behavior is elastic-ductile when short-term compression tests are considered; it is elastic-fragile when tensile tests are considered. (The same can be said of effective tensile tests—*i.e.*, when a confining brine pore pressure larger than the smallest applied compressive main stress is applied.) In the long term, salt behaves as a fluid in the sense that it flows even under very small deviatoric stresses, but, even in this case, steady-state creep (reached after several weeks or months) must be distinguished from transient creep (which is effective during a several week period after mechanical loading is applied).

Interesting attempts have been made to capture these various features in a unique comprehensive mechanical-behavior model (Cristescu, 1993; Cristescu and Hunsche, 1996; Munson, 1997; Aubertin *et al.*, 1998; Weidinger *et al.*, 1998; Hampel *et al.*, 1998). However, the number of parameters to be identified through laboratory tests for such models is often out of practical reach. From an engineering perspective, it is easier (and less costly) to select typical situations in which one or the other of the various features of complex salt behavior plays a preeminent role, allowing other aspects of importance in other contexts to be disregarded.

When computing the amount of fluid expelled from a cavern as a consequence of a blow-out (*Section 1.2*) or the amount of brine to be injected in a cavern to pressurize it, the compressibility (*i.e.*, elastic properties) of the fluid-plus-cavern system is important (Bérest *et al.*, 1999). When the very long-term behavior of a constant-pressure liquid-filled cavern is considered, steady-state creep behavior provides a good approximation of the overall trend.

When performing a tightness test, at the beginning of which cavern pressure is rapidly built up, short-term transient creep must be taken into account; when neglected, it can lead to gross misinterpretation of the test results (Hugout, 1988; Bérest *et al.*, 2001b). When natural gas caverns, operated at varying pressures, are examined, transient creep (Aubertin *et al.*, 1993; Munson, 1999) and the duration of each pressure step must be taken into account. Finally, rock damage and coupled hydromechanical behavior must be considered both when the cavity pressure is very low (Cosenza and Ghoreychi, 1996; Pfeifle *et al.*, 1998; Pfeifle and Hurtado, 2000) or close to geostatic pressure (*see Section 4*).

Many other aspects are still open to discussion—for instance, modification of the steady-state creep law when low deviatoric stresses are considered (Charpentier *et al.*, 1999; Wallner *et al.*, 2000), the effect of moisture content in gas caverns (Horseman, 1988; Hunsche and Schulze, 1996), fracture mechanics and healing (Munson *et al.*, 1999).

There is a little doubt that we have not heard the last about the mechanical behavior of salt.

4 CAVERN ABANDONMENT

4.1 Introduction

In the past several years, there has been concern about the thermohydromechanical behavior of deep underground salt caverns after they have been sealed and abandoned. Interest in the very long-term behavior of such abandoned caverns has increased due to concerns for environmental protection, on one hand, and to several new projects in which caverns are used for disposal of nonhazardous, low-level nuclear or industrial wastes, or carbon dioxide on the other (Wassmann, 1983; Ghoreychi and Cosenza, 1993; Rolfs *et al.*, 1996; Tomasko *et al.*, 1997; Bérest *et al.*, 1997a; Brassow and Thoms, 2000; Dusseault *et al.*, 2001). The SMRI has set this problem at the center of its research program (Ratigan, 2000) and has supported the Etrez test described in this chapter.

In most cases, prior to abandonment, the cavern will be filled with brine. Then a special steel plug will be set at casing seat (Pfeifle *et al.*, 2000), and cement will be poured in the well, isolating a large “bubble” of fluid, the evolution of which is the main concern of the present chapter.

After the cavern is sealed and abandoned, the cavern brine pressure will build up, as proven by many “shut-in pressure tests” (see, for instance, Bérest *et al.*, 1979; Van Sambeek, 1990; You *et al.*, 1994; Fokker, 1995). Bérest *et al.* (2000a) describe several case histories in which initial pressure build-up rates in a closed cavern range from 4 MPa/year to 10 MPa/year—still more in very deep caverns, as the rate is faster when the cavern is younger, deeper or smaller.

The final value of cavern brine pressure is of utmost importance from the perspective of environmental protection. In salt formations, the natural state of stress resulting from overburden weight is generally assumed to be isotropic; this geostatic pressure (P_∞) is P_∞ (MPa) = 0.022 H (m) at cavern depth (H). Several authors (Wallner, 1988; Bérest and Brouard, 1995) think that, in many cases, brine pressure will eventually reach a figure larger than the geostatic pressure, leading to hydrofracturing. There is some risk that brine flows upward through fractures, to shallow water-bearing strata, leading to water pollution, cavern collapse and subsidence. The consequences will be more severe when the cavern contains wastes. To which point this pessimistic scenario can be alleviated by taking into account salt permeability will be discussed later.

4.2 Factors Contributing to Pressure Build-Up

4.2.1 Cavern Compressibility

As explained in Section 1.2.1, a brine-filled closed cavern is a stiff body: a small reduction in cavern volume or a small increase in brine volume yields to a significant brine pressure build-up, or $\delta V/V = \beta \delta P_i$, where a typical value of the cavern compressibility factor is $\beta = 4 \cdot 10^{-4}$ MPa⁻¹, although larger values can be encountered (Bérest *et al.*, 1999).

4.2.2 Cavern Creep

The role of cavern creep has been clearly identified—see, for instance, Wallner (1988), Cauberg *et al.* (1986), Van Sambeek (1990), Bérest (1990), Rolfs *et al.* (1996), Ghoreychi and Cosenza (1993), Wallner and Paar (1997) and Wallner *et al.* (2000).

As mentioned in Section 3.1, any salt cavern progressively loses volume: the driving force is the gap between the overburden (*i.e.*, geostatic) pressure and the cavity internal pressure. As salt mass creeps toward a cavern, leading to cavern shrinkage, the cavern brine is offered smaller room, and its pressure builds up in a sealed cavern. Typical rates at the beginning of the process are $\dot{V}/V = -3 \cdot 10^{-4}$ /year ($\dot{P}_i = 0.75$ MPa/year) in a 1000 m deep cavern and $\dot{V}/V = -3 \cdot 10^{-2}$ /year ($\dot{P}_i = 75$ MPa/year) in a 2000 m deep cavern. After some time, the process becomes slower as the cavern pressure becomes higher, ultimately stopping when the cavern pressure is equal to geostatic ($P_i = P_\infty$), after several centuries (Wallner and Paar, 1997).

This process can be computed easily when the constitutive behavior of the rock salt is known. However, it is suspected that standard constitutive laws (inferred from laboratory creep tests performed under relatively high deviatoric stresses) underestimate the actual creep rates observed at the end of the process, when cavern pressure is high (Charpentier *et al.*, 1999; Wallner *et al.*, 2000).

4.2.3 Final Equilibrium

It is expected that creep ends when the cavity pressure balances the overburden pressure ($P_i = P_\infty$). In fact, as pointed out by Wallner (1988) and Ehgartner and Linn (1994), an exact balance is reached only at cavern mid-depth. Salt rock is heavier than brine and, in the final state, brine pressure at the cavern top will exceed the geostatic pressure by an amount that is larger when the cavern is taller. If the cavern is tall enough, the rock tensile strength will be exceeded, and fracturing becomes likely. (For analyses of salt fracturing, see Schmidt, 1993; Durup, 1994; Rummel *et al.*, 1996; Rokahr *et al.*, 2000 and Staudtmeister and Schmidt, 2000.)

4.2.4 Brine Thermal Expansion

The natural temperature of rock increases with depth. Caverns are leached out using soft water pumped from shallow aquifers with low temperatures. The transit time of water in the cavern is a few days or weeks long—insufficient for brine to warm, which means that the temperature of the brine in the cavern at the end of the leaching phase is lower than the natural temperature of rock by several dozens of celsius degrees. The same can be said for a storage cavern filled with brine before being abandoned.

The initial temperature gap between the cavern brine and the rock formation slowly resorbs with time when the cavern is kept idle. The warming process can be dozens of years long (shorter in a small cavern). The process is easy to compute: thermal conduction takes place into the rock mass, and the heat flux is directed toward the cavern, whose temperature is almost uniform, because cavern brine is the seat of convection patterns that stir up the fluid, as has been proven by field observations (Bérest *et al.*, 2001c).

Heated brine expands, leading to a pressure build-up in a closed cavern (Bérest *et al.*, 1979; Ehgartner and Linn, 1994; Bérest *et al.*, 1997b; Wallner *et al.*, 2000). Since the thermal expansion coefficient of brine is $\alpha = 4.4 \cdot 10^{-4}$ °C⁻¹, a 1°C temperature increase leads to an (approximate) $\beta/\alpha = 1$ MPa pressure build-up.

In an actual cavern, cavern creep and brine thermal expansion combine to produce a build-up in brine pressure (Bérest and Brouard, 1995). In most cases, temperature increase is the preeminent factor, although an exception can be found in very deep caverns (You *et al.*, 1994).

4.3 Factors Contributing to Pressure Release

4.3.1 Rock Salt Permeability

Rock salt exhibits a very low permeability, because the hydraulic conductivity of its matrix is extremely small (even when the natural salt formations contain a fair amount of insoluble rocks, anhydrite or clay interbedded layers) and

because no fractures exist in a massive salt formation (except, perhaps, in some disturbed zones encountered at the fringes of salt domes). Figures as small as $K = 10^{-22} \text{ m}^2$ to 10^{-20} m^2 are reported. Several authors believe that most of this (small) permeability is induced by the cavern creation and operation (more precisely, either by tensile or high deviatoric stresses developed at the cavern wall, when the cavern fluid pressure is very high or very small, respectively). In fact, permeability is so small that its measurement is beyond the standard techniques used for more permeable rocks (say, rocks with permeability larger than $K = 10^{-17} \text{ m}^2$) and few reliable *in situ* test results are available. For example, experiments performed in an air-intake shaft at the WIPP site provide permeabilities as low as $K = 10^{-21} \text{ m}^2$ for undisturbed salt (Dale and Hurtado, 1997). Durup (1994) performed a one-year test in a 1000 m deep well in the Etrez upper salt formation, where anhydrite and clay interbeds are present. This test consisted of the incremental build-up of brine pressure in the well. Brine is injected daily to keep the well pressure constant during each step. Assuming Darcy's law, Durup computed an average permeability of $K = 6 \cdot 10^{-20} \text{ m}^2$ in the 200 m high unlined deeper part of the well. Brouard *et al.* (2001) compiled a dozen of similar but shorter tests performed in the Etrez lower salt formation and in the Tersanne salt formation: respective back-calculated permeabilities were:

$$K = 4.6 \cdot 10^{-21} \text{ to } 1.9 \cdot 10^{-20} \text{ m}^2$$

and

$$K = 8.6 \cdot 10^{-22} \text{ to } 3.2 \cdot 10^{-21} \text{ m}^2.$$

More recently, at the Etrez site, an 18-month test in a full-sized cavern provided $K = 2 \cdot 10^{-19} \text{ m}^2$ (Bérest *et al.*, 2001c). This larger figure is consistent with the generally accepted effects of scale on rock permeability (Brace, 1980). How low these figures are is illustrated clearly by a simple example in which $K = 10^{-20} \text{ m}^2$ and the pressure in the storage cavern is larger than the natural pore pressure in the rock mass by 10 MPa. Then, for a 100 000 m^3 cavern, brine seepage will be 1 m^3/year . Even if very small, such very slow flows must be taken into account when long-term cavern behavior is considered. In fact, in this context, "slightly permeable" and "impermeable" formations must be distinguished.

4.3.2 Slightly Permeable Salt Formations

In some cases, the micro-permeability of salt allows the brine pressure in a closed cavern to be released. This statement is true when the thermal expansion effects of brine have dissipated and when the rock permeability is relatively high ($K = 10^{-20} - 10^{-19} \text{ m}^2$). Then an equilibrium state can be reached when brine outflow toward the rock mass exactly balances the cavern volume loss due to creep. An *in situ* test performed at the Etrez site in France supports this view and is described below.

4.3.3 Impermeable Salt Formations

When salt-formation permeability is even smaller ($K < 10^{-21} \text{ m}^2$), no significant pressure release is allowed by brine permeation. However, the pioneering work of Fokker (1995) strongly suggested that a "secondary" permeability can be induced by high brine pressure in the cavern: tensile effective stresses at cavern wall provoke rock damage and a porosity/permeability increase. (Such a phenomenon must be distinguished from discrete fracture creation, which is the ultimate result of this damaging process. With regard to hydraulic fracturing in salt, see Section 4.2.3 references.) Fokker's view has been confirmed by later SMRI-supported tests performed on hollow spherical samples (Bérest *et al.*, 2000b and 2001a).

Computations have proven that this permeability increase is probably large enough to allow significant brine outflow from the cavern (Ehgartner and Tidwell, 2000). An earlier *in situ* test, performed at the Etzel site in Germany (Rokahr *et al.*, 2000), was reinterpreted within the light of this induced, or secondary, permeability notion (Hauck *et al.*, 2001; see below).

Although still open to discussion, a stress-induced permeability increase can provide optimistic scenarios for the long-term behavior of a closed cavern in an impermeable salt formation: when high fluid pressures are involved, the rock mass self-adapts to prevent fracturing. In-situ validations are still needed.

4.4 The Etrez 53 Test

This *in situ* test, performed in a cavern at the *Gaz de France* storage site in Etrez, has been supported by the SMRI (Bérest *et al.*, 2001c). Ez53 is a relatively small cavern ($V = 7500 \pm 500 \text{ m}^3$) leached out in Spring 1982. Temperature profiles performed in Winter 1996 proved, as expected, that thermal equilibrium was reached 14 years after solution mining was completed. At this point, cavern behavior is governed by cavern creep and brine permeation. The cavern is 50 m high and has an average depth of 950 m; at such depth, moderate creep rates are expected. Brouard (1998) measured the cavern creep rate when the well was opened to atmosphere and found that relative volumetric loss rate was approximately $\dot{V}/V = -3 \cdot 10^{-4} \text{ year}^{-1}$, see Section 3.1. Quintanilha (1996), taking into account cavern pressure variations from 1982 to 1996, proved that the cavern steady-state creep rate was reached at the end of this period.

Permeability of the Etrez salt formation was assessed through various *in situ* tests. Standard liquid leak tests (see Section 2.5) performed on several wells (Brouard *et al.*, 2001) have proven that the rock salt permeability was relatively high ($K = 4.6 \cdot 10^{-21}$ to $1.9 \cdot 10^{-20} \text{ m}^2$). These figures had been confirmed by a one-year SMRI-supported test by Durup (1994).

The test objective was to prove that the combined effects of cavern creep and brine permeation through the rock mass cause the cavern brine pressure to reach equilibrium when the cavern volumetric convergence rate (due to salt creep) exactly balances the brine outflow from the cavern (due to rock mass permeability).

To prevent gross misinterpretation, the annular space was filled with a light liquid, and an interface displacement rate measurement method was designed to detect any fluid loss through the cemented casing (Bérest *et al.*, 2001c). This system was accurate enough to allow indirect measurement of Earth tidal effects on cavern volume.

The test basically consisted of a trial-and-error process. Different cavern pressures were tested successively. When the well-head pressure rate remained consistently negative (or positive) for a sufficiently long period of time, it was readjusted to a smaller (or higher) value through fluid withdrawal (or injection) in hopes of triggering a change in sign for the well-head pressure rate.

Results of the 500 day test are displayed on Figure 17: the cavern pressure decreases when higher than $P_i = 13.0 \pm 0.1$ MPa (permeation prevails over creep) and increases when smaller than this value. (Creep prevails over permeation.) The equilibrium pressure is much smaller than the geostatic pressure, which is $P_\infty = 20.5$ MPa.

Whether these results can be extended to other caverns is an open question. It should be kept in mind that several conditions make Ez53 a good candidate for low-equilibrium pressure: it is a small cavern (permeation is more effective in a small cavern.), and the Etrez salt formation is probably more permeable than many others. (For a comparison

between the permeabilities of Etrez and Tersanne salt, see Brouard *et al.*, 2001.)

4.5 The Etsel K102 Test

A complete description of this *in situ* test, conducted by Consortium Druckaufbaute K102, can be found in Rokahr *et al.* (2000). The K102 cavern is located at an oil-storage site in Etsel, Germany. It is a 233 000 m³ cavern with a casing-shoe depth of 827.7 m. This 662 m high cavern (cavern roof depth = 850 m) was selected to “quantify the internal pressure in a brine filled cavern at the point of losing tightness” (Rokahr *et al.*, 2000, p. 90). Pressure was built up slowly from gradient $0.12 \cdot 10^{-1}$ MPa/m to gradient $0.22 \cdot 10^{-1}$ MPa/m and more (see Fig. 18); the geostatic gradient is believed to be in the range $0.2075 \pm 0.0035 \cdot 10^{-1}$ MPa/m. (Slightly higher values were assumed before the test.)

- During the first injection (up to a gradient of $0.19 \cdot 10^{-1}$ MPa/m), the cavern compressibility factor was $\beta = 4 \cdot 10^{-10}$ Pa⁻¹—a standard figure. (500 m³ of brine were injected during this phase.) The apparent compressibility of the cavern drastically increased during later injections.
- During the second step, 134.4 m³ were injected, to reach a gradient of $0.205 \cdot 10^{-1}$ MPa/m;
- During the third step, 179.5 m³ were injected to reach a gradient of $0.219 \cdot 10^{-1}$ MPa/m, after which the pressure began to drop.
- After two months, extrapolation to a final gradient of $0.217 \cdot 10^{-1}$ MPa/m was made. How thermal expansion and brine permeation (cavern creep is negligible in this context) combine to provide this asymptotic value is difficult to assess.
- During the fourth phase, injection resumed at a constant flow rate: a first pressure peak (gradient $0.223 \cdot 10^{-1}$ MPa/m) was reached, followed by a negative pressure rate period. Two other pressure peaks were observed.

It is clear that increased brine permeation took place at least during the fourth injection phase. The results of the tests were explained by the onset of a secondary permeability (induced by brine pressure, when very near to rock stresses at the cavern wall). This assumption found some support in Fokker’s laboratory test results (1995). Results of additional numerical computations are provided in Hauck *et al.* (2001).

Somewhat similar observations had been made in closed caverns at the Vauvert site in France. After a fast pressure build-up, mainly governed by cavern creep (which is very effective in these 2000 m deep caverns), the pressure-versus-time curve reached a plateau (Bérest *et al.*, 1979). No additional pressure build-up takes place, although thermal expansion is active: cavern “permeability” increase is likely. In this brine production site, however, caverns had been linked by hydrofracturing before leaching began, and the re-opening of preexisting fractures, rather than a more diffuse permeability increase, can be suspected.

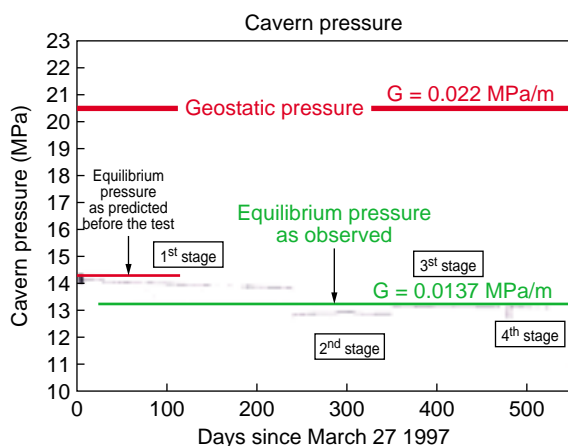

Figure 17

The Etrez test (after Bérest *et al.*, 2001c). In this closed cavern, brine pressure reaches an equilibrium value when the brine volume loss due to permeation balances cavern volume loss due to creep.

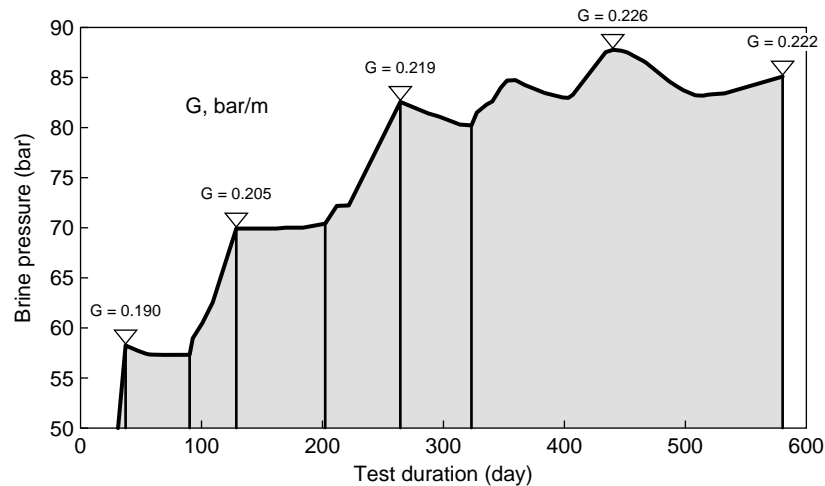

Figure 18

The Etzel test (after Rokahr *et al.*, 2000). Increasing pressure gradients are applied in the sealed cavern. When a 0.219 bar/m (0.0219 MPa/m) gradient is reached, the apparent permeability of the cavern drastically increases.

CONCLUSION

Underground storage safety entails many participants: operators, owners, consultants, regulatory authorities, unions, local public representatives and insurance companies—to name a few. The perspectives of these various participants do not coincide—they converge to a certain equilibrium point. Even in two contiguous states, the equilibrium point, as defined, for instance, by regulations, can differ widely. This equilibrium point moves slowly, at the pace of state-of-the-art advances; it moves more rapidly after an accident highlights a weakness of the safety system. The authors hope that their descriptions of several case studies are helpful in this respect.

ACKNOWLEDGEMENTS

The authors are indebted to many colleagues who provide them with fruitful comments. Joe Ratigan indicated several earlier misinterpretations of data. They especially thank the *Organizing Committee* of the 8th Portuguese Geotechnics Society Congress, who authorized reprinting of materials contained in the Proceedings of this Congress. The authors take full responsibility for errors in the description of the accidents. Special thanks go to Gérard Durup, Mehdi Ghoreychi and Kathy Sikora.

REFERENCES

Allison M.L. (2001) Hutchinson, Kansas; A geological detective story. *Geotimes*, Web site, www.agiweb.org.
 Aubertin M., Gill D.E. and Landanyi B. (1993) Modeling the transient inelastic flow of rocksalt. *Proc. 7th Symp. on Salt*,

Kakahana H., Hardy R.H. Jr, Hoshi T., Toyokura K. eds, Elsevier, I, 93-104.

Aubertin M. and Hardy R.H., editors (1998). *Proc. 4th Conf. Mech. Beh. of Salt*, Montreal, June 1996. Trans Tech Pub., Clausthal-Zellerfeld, Germany.

Aubertin M., Sgaoula J., Servant S., Julien M.R., Gill D.E. and Landanyi B. (1998) An Up-to-Date Version of SUVIC-D for Modeling the Behavior of Salt. *Proc. 4th Conf. Mech. Beh. of Salt*, Montréal, June 1996, Trans. Tech. Pub., Clausthal-Zellerfeld, Germany, 205-220.

Baar C.A. (1977) Applied salt-rock mechanics, 1. In: *Developments in Geot. Eng.* 16-A, 143-147. Elsevier Science, Amsterdam.

Bérest P., Ledoux E., Legait B. and de Marsily G. (1979) Effets thermiques dans les cavités en couches salifères. *Proc. 4^e congrès SIMR*, Montreux, Septembre 1979, I, Balkema, Rotterdam, 31-35.

Bérest P., Ghoreychi M., Fauveau M. and Lebitoux P. (1986) Mechanism of Creep in Gas storage caverns. Effects of gravity forces. *Proc. 27th US Symp. on Rock Mech.*, Hartman H.L. editor, Society of Mining Engineers, Inc., Littleton, Colorado, 789-794

Bérest P. (1990) Les problèmes soulevés par l'abandon des cavités de dissolution profondes dans le sel gemme. In: *Stockage en souterrain*, Presses des Ponts et Chaussées, 115-130.

Bérest P. and Brouard B. (1995) Behavior of sealed solution-mined caverns. *Proc. SMRI Spring Meeting*, New Orleans. (Proceedings of the "SMRI Meetings" are available at: SMRI-3336, Lone Hill Lane, Encinitas, CA 9204-7262, USA. These Proceedings are edited as a separate volume since the Fall 1996 Meeting).

Bérest P., Brouard B., Beugin F., and Goldberg J. (1997a) Storage of tritiated waters in salt caverns. *Proc. SMRI Fall Meeting*, El Paso, 49-63.

Bérest P., Brouard B., and Durup J.G. (1997b) Behavior of sealed solution-mined caverns. *Proc. 4th Conf. Mech. Beh. of Salt*, Montréal, June 1996, Trans. Tech. Pub., Clausthal-Zellerfeld, Germany, 511-524.

Bérest P., Bergues J. and Brouard B. (1999) Review of static and dynamic compressibility issues relating to deep underground caverns. *Int. J. Rock Mech. Min. Sci.*, **36**, 8, 1031-1049.

- Bérest P., Brouard B. and Durup G. (2000a) Shut-in pressure tests – case studies. *Proc. SMRI Fall Meeting*, San Antonio, 105-126.
- Bérest P., Brouard B. and de Greef V. (2000b) Salt permeability testing - the influence of permeability and stress on spherical hollow salt samples. *Technical Report RFP 98-1 for the Solution Mining Research Institute*.
- Bérest P., Brouard B. and de Greef V. (2001a) Salt permeability testing. *Technical Report RFP 98-1 – Part 2 for the Solution Mining Research Institute*.
- Bérest P., Brouard B. and Durup J.G. (2001b) Tightness tests in salt-cavern wells. *Oil & Gas Science and Technology - Rev. IFP*, **56**, 5, 451-469.
- Bérest P., Bergues J., Brouard B., Durup J.G. and Guerber B. (2001c) A salt-cavern abandonment test. *Int. J. Rock Mech. Min. Sci.* **38**, 2, 343-355.
- Boucly Ph. and Legreneur J. (1980) Hydrocarbon Storage in Cavities leached out of Salt Formations. *Proc. Int. Symp. Rock Store*, M. Bergman ed., Pergamon, I, 251-257.
- Boucly P. (1984) *In situ* experience and mathematical representation of the behavior of rock salt used in storage of gas. *Proc. 1st Conf. Mech. Beh. of Salt*, Pennsylvania, November 1981. Trans Tech Pub., Clausthal-Zellerfeld, Germany, 453-471.
- Brace W.F. (1980) Permeability of crystalline and argillaceous rocks. *Int. J. Rock Mech. & Mining Sci.*, **17**, 241-251.
- Brassow C.L. and Thoms R.L. (2000) Use of solution-mined caverns for the disposal of hazardous and industrial waste products. *Proc. 8th World Salt Symp.*, R.M. Geertman ed., Elsevier, I, 229-235.
- Brouard B. (1998) On the behavior of solution-mined caverns (in French). *Thesis Dissertation*, École polytechnique, France.
- Brouard B. and Bérest P. (1998) A classification of salt according to their creep properties. *Proc. SMRI Spring Meeting*, New Orleans, 18-38.
- Brouard B., Bérest P. and Durup J.G. (2001) *In situ* salt permeability testing. *Proc. SMRI Fall Meeting*, Albuquerque, 139-157.
- Cauberg H., Kuilman B., Valkering B. and Walters J.V. (1986) Rock mechanical behavior and sealing aspects of a closed-in salt cavity filled with brine. *Proc. SMRI Fall Meeting*, Amsterdam.
- Charpentier J.P., Bérest P. and Blum P.A. (1999) Creep of a rock salt under small loading. *Proc. SMRI Fall Meeting*, Washington DC, 11–24.
- Coates G.K., Lee C.A., McClain W.C. and Senseny P.E. (1983) Closure and Collapse of Man-Made Cavities. *Proc. 6th Symp. on Salt*, Shreiber B.C ed., The Salt Institute, II, 139-157.
- Cole R. (2002) The Long Term Effects of High Pressure Natural Gas Storage on Salt Caverns. *Proc. SMRI Spring Meeting*, Banff, 75-97.
- Cosenza P. and Ghoreychi M. (1996) Coupling between mechanical behavior and transfer phenomena in salt. *Proc. 3rd Conf. Mech. Beh. of Salt*, Palaiseau, September 1993. Trans Tech Pub., Clausthal-Zellerfeld, Germany, 285–307.
- Cristescu N., Hardy R.H. Jr. and Simionescu R.O., editors (2002) *Proc 5th Conf. Mech. Beh. of Salt*, Bucarest, August 1999, Balkema.
- Cristescu N. (1993) A general Constitutive Equation for Transient and Stationary creep of Rock Salt. *Int. J. Rock Mech. Min. Sc. Geomech. Abst.*, **30**, 2, 125-140.
- Cristescu N. and Hunsche U. (1996) A comprehensive constitutive equation for rock salt: determination and application. *Proc. 3rd Conf. Mech. Beh. of Salt*, Palaiseau, September 1993. Trans Tech Pub., Clausthal-Zellerfeld, Germany, 177-191.
- Crotogino F.R. (1995) SMRI References for External Well Mechanical Integrity Testing/Performance, Data Evaluation and Assessment. *Summary of the Final Project Report*, SMRI 95-0001.
- Dale T. and Hurtado L.D. (1997) WIPP air-intake shaft disturbed-rock zone study. *Proc. 4th Conf. Mech. Beh. of Salt*, Montréal, June 1996. Trans. Tech. Pub., Clausthal-Zellerfeld, Germany.
- Denzau H. and Rudolph F. (1997) Field test for determining the convergence of a gas storage cavern under load conditions frequently changing between maximum and minimum pressure and its finite element modelling. *Proc. SMRI Spring Meeting*, Cracow, 71-84.
- DeVries K.L. and Nieland J.D. (1999) Feasibility study for lowering the minimum gas pressure in solution-mined caverns based on geomechanical analyses of creep-induced damage and healing. *Proc. SMRI Spring Meeting*, Las Vegas, 153-182.
- DeVries K.L., Mellegard K. and Callahan G.D. (2002) Proof-of-concept research on a salt damage criterion for cavern design: a project status report. *Proc. SMRI Spring Meeting*, Banff, 107-127.
- DOE (US Department of Energy) (1980) *OSC Strategic Petroleum West Hackberry Oil Storage Cavern Fire and Spill After Action Report*, I.
- Dreyer W. (1972) The Science of Rock Mechanics, 1. The Strength Properties of Rocks. *Trans. Tech. Pub.*, Clausthal-Zellerfeld, Germany.
- Durup J.G. (1991) Relationship between subsidence and cavern convergence at Tersanne (France). *Proc. SMRI Spring Meeting*, Atlanta.
- Durup J.G. (1994) Long term tests for tightness evaluations with brine and gas in salt. *Proc. SMRI Fall Meeting*, Hannover.
- Durup J.G., Xu J. (1996) Comparative study of certain constitutive laws used to describe the rheological deformation of salts. *Proc. 3rd Conf. Mech. Beh. of Salt*, Palaiseau, September 1993. Trans. Tech. Pub., Clausthal-Zellerfeld, Germany, 75-83.
- Dusseault M.B., Bachu S. and Davidson B.C. (2001) Carbon dioxide sequestration potential in salt solution caverns in Alberta, Canada. *Proc. SMRI Fall Meeting*, Albuquerque, 77-96.
- Ehgartner B.L. and Linn J.K. (1994) Mechanical behavior of sealed SPR caverns. *Proc. SMRI Spring Meeting*, Houston.
- Ehgartner B. and Tidwell V. (2000) Multiphase flow and cavern abandonment. *Proc. SMRI Fall Meeting*, San Antonio, 73-86.
- Fenix & Scisson Inc. Eminence storage facility station 77 operating summary, November 1979 through April 1980. *Unpublished report prepared for Transcontinental Gas Pipe Line Corporation, Report No. 4, 23*, quoted in Coates *et al.*, 1983.
- Fokker P.A. (1995) The behavior of salt and salt caverns. *Thesis Dissertation*, Delft University of Technology, Pays-Bas.
- Furiga R.D. and Smith R.E. (1983) The development of the strategic petroleum reserve of the USA. *Annales des Mines*, 5-6, 47-62.
- Gebhardt F., Eby D. and Barnette D. (2001) Utilizing coiled tubing technology to control a liquid propane storage well fire, A case history. *Proc. SMRI Spring Meeting*, Orlando, 301-308.
- Ghoreychi M. and Cosenza P. (1993) Quelques aspects de la sûreté à long terme des stockages dans le sel. *Proc. 4^e Colloque Franco-Polonais*, Nancy, 209-217.
- Guerber B. and Durup J.G. (1996) A Few applications of the utilization of a 3D geomechanical code for underground storage cavern design and stability studies. *Proc. SMRI Spring Meeting*, Houston.
- Hampel A., Hunsche U., Weidinger P. and Blum W. (1998) Description of the Creep of Rock Salt with The Composite model. II steady-state creep. *Proc. 4th Conf. Mech. Beh. of Salt*,

- Montréal, June 1996, *Trans. Tech. Pub.*, Clausthal-Zellerfeld, Germany, 287-299.
- Hardy R.H. Jr and Langer M., editors. (1984) *Proc. 1st Conf. Mech. Beh. of Salt*, Pennsylvania, November 1981, *Trans. Tech. Pub.*, Clausthal-Zellerfeld, Germany.
- Hardy R.H. Jr and Langer M., editors. (1988) *Proc. 2nd Conf. Mech. Beh. of Salt*, Hannover, September 1984, *Trans. Tech. Pub.*, Clausthal-Zellerfeld, Germany.
- Hardy H.R. Jr, Chabannes C.R. and Mrugola M. (1983) Laboratory and theoretical studies relative to the design of salt caverns for the storage of natural gas. *Proc. 6th Symp. on Salt*, B.C. Shreiber and H.L. Harner ed., Salt Institute, I, 385-416.
- Hardy R.H. Jr, Langer M., Bérest P. and Ghoreychi M., editors. (1996) *Proc. 3rd Conf. Mech. Beh. of Salt*, Palaiseau, September 1993, *Trans. Tech. Pub.*, Clausthal-Zellerfeld, Germany.
- Hauck R., Staudtmeister K. and Zander-Schiebenhöfer D. (2001) The results of the numerical simulation of the Etzel test. *Proc. SMRI Spring Meeting*, Orlando, 213-226.
- Horseman S.T. (1988) Moisture content. A major uncertainty in storage cavity closure prediction. *Proc. 2nd Conf. Mech. Beh. of Salt*, Hannover, September 1984, *Trans. Tech. Pub.*, Clausthal-Zellerfeld, Germany, 53-68.
- Hugout B. (1988) Mechanical behavior of salt cavities - *in situ* tests - model for calculating the cavity volume evolution. *Proc. 2nd Conf. Mech. Beh. of Salt*, Hannover, September 1984, *Trans. Tech. Pub.*, Clausthal-Zellerfeld, Germany, 291-310.
- Hunsche U. and Schulze O. (1996) Effects of humidity and Confining Pressure on Creep of Rock Salt. *Proc. 3rd Conf. Mech. Beh. of Salt*, Palaiseau, September 1993, *Trans. Tech. Pub.*, Clausthal-Zellerfeld, Germany, 237-248.
- Johnson D.O. and Seni S.J. (2001) Regulation of hydrocarbon storage operations in Texas. *Proc. SMRI Spring Meeting*, Orlando, 111-120.
- Johnson W. (2002) KDHE unveils gas storage rules. *Hutchinson News*, 28 July 2002.
- Kansas Geological Survey Web Site (2001) *Hutchinson Response Project*, [www.kgs.ukans.edu/Hydro/Hutch/General Geology/index.html](http://www.kgs.ukans.edu/Hydro/Hutch/General%20Geology/index.html) and www.kgs.ukans.edu/Hydro/Hutch/references.html.
- Klafki, M., Bannach, A. and Achtzehn, L. (1998) Modeling and Control of Cavern Development for Underground Gas Storage Stassfurt, Germany. *Proc. SMRI Spring Meeting*, New Orleans, 154-173.
- Krieter M., Frohwein A. and Benke K. (1997) The impact of the operating mode of gas storage caverns on convergence development. *Proc. SMRI Spring Meeting*, Cracow, 345-357.
- Lux K.H. and Rokahr R.B. (1980) Some remarks on theoretical simulation models in salt cavern construction with regard to the evaluation of discharge measurements. *Proc. Int. Symp. Rock Store*, M. Bergman ed., Pergamon, I, 329-335.
- Menzel W. and Schreiner W. (1983) Results of rock mechanical investigations for establishing storage cavern in salt formations. *Proc. 6th Symp. on Salt*, B.C. Shreiber and H.L. Harner ed., Salt Institute, I, 501-510.
- Menzel W. and Schreiner W. (1989) Geomechanical aspects for the establishment and the operation of gas cavern stores in salt formations of the GDR. *Proc. Int. Symp. Storage of Gases in Rock Caverns*, B. Nilsen and J. Olsen eds., Balkema, 115-120.
- Munson D.E. (1997) Constitutive model of the creep of rock salt applied to underground room closure. *Int. J. Rock Mech. Min. Sc. Geomech. Abst.*, **34**, 2, 233-247.
- Munson D.E. (1999) Transient analysis for the multimechanism-deformation parameters of several domal salts. *Proc. SMRI Fall Meeting*, Washington DC, 275-298.
- Munson D.E., Chan K.W. and Fossum A.F. (1999) Fracture and healing of rock salt related to salt caverns. *Proc. SMRI Spring Meeting*, Las Vegas, 67-90.
- National Transportation Safety Board (NTSB) (1993) *Highly Volatile Liquids Release from Underground Storage Cavern and Explosion*, Mapco Natural Gas Liquids Inc., Brenham Texas, April 7, 1992, *NTSB/PAR-93/01, PB93-916502*.
- Nguyen Minh D., Maitourman H., Braham S. and Durup J.G. (1993) A tentative interpretation of long-term surface subsidence measurements over a solution mined cavern field. *Proc. 7th Symp. on Salt*, Kakihana H., Hardy H.R. Jr, Hoshi T., Toyokura eds. Elsevier, I, 441-450.
- Pfeifle T.W., DeVries K.L. and Nieland J.D. (1998) Damage - induced permeability enhancement of natural rock salt with implications for cavern storage. *Proc. SMRI Spring Meeting*, New Orleans, 260-289.
- Pfeifle T.W. and Hurtado L.H. (2000) Effect of pore pressure on damage accumulation in salt. *Proc. 8th World Salt Symp.*, R.M. Geertman ed., Elsevier, I, 307-312.
- Pfeifle T.W., Mellegard K.D. and Bruno M.S. (2000) Casing Sealing Study: Status Report. Solution Mining Research Institute research program (RFP-98-3). *Proc. SMRI Fall Meeting*, San Antonio, 139-163.
- Quast P. and Schmidt M.W. (1983) Disposal of Medium- and low-level radioactive waste (MLW/LLW) in leached caverns. *Proc. 6th Symp. on Salt*, Schreiber B.C. and Harner H.L. eds., The Salt Institute, II, 217-234.
- Quintanilha de Menezes J.E. and Nguyen Minh D. (1996) Long term subsidence, prediction above storage cavity fields in salt layers. *Proc. SMRI Fall Meeting*, Cleveland, 249-273.
- Quintanilha de Menezes J.E. (1996) Méthodes analytiques et numériques pour l'étude des cavités salines profondes. *Thesis Dissertation*, École polytechnique, Palaiseau, France.
- Ratigan J. (1991) Ground subsidence at Mount Belvieu, Texas (panel discussion - surface subsidence). *SMRI Spring Meeting*, Atlanta.
- Ratigan J. (2000) A Status Report on the SMRI cavern sealing and abandonment program. *Proc. SMRI Fall Meeting*, San Antonio, 164-178.
- Röhr H.U. (1974) Mechanical behavior of a gas storage cavern in evaporitic rocks. *Proc. 4th Symp. on Salt*, A.H. Coogan ed., Salt Institute, II, 93-100.
- Rokahr R. and Staudtmeister K. (1993) Rock mechanical study of the load-bearing behaviour of a gas cavern in rock salt after a blow out. *Proc. 7th Symp. on Salt*, Kakihame H., Hardy H.R. Jr, Hoshi T., Toyokura K. eds, Elsevier, I, 477-482.
- Rokahr R.B., Hauck R., Staudtmeister K. and Zander-Schiebenhöfer D. (2000) The results of the pressure build-up test in the brine filled cavern Etzel K102. *Proc. SMRI Fall Meeting*, San Antonio, 89-103.
- Rolfes O., Schmidt U. and Crotogino F. (1996) Rock mechanical studies on the post-operational phase of a disposal cavern. *Proc. 3rd Conf. Mech. Beh. of Salt*, Palaiseau, September 1993, *Trans Tech Pub*, Clausthal-Zellerfeld, Germany, 417-26.
- Rummel F., Benke K. and Denzau H. (1996) Hydraulic fracturing stress measurements in the Krummhörn gas storage field, northwestern Germany. *SMRI Spring Meeting*, Houston.
- Schmidt Th. (1993) Fracture tests for determining primary stress conditions in salt deposits provide clues to the rock mechanics of salt caverns. *Proc. 7th Symp. on Salt*, Kakihame H., Hardy H.R. Jr, Hoshi T., Toyokura K. eds, Elsevier, I, 135-140.
- Schmidt U. and Staudtmeister K. (1989) Determining minimum permissible operating pressure for a gas cavern using the finite element method. *Proc. Int. Conf. Storage of Gases in Rock Caverns*, B. Nilsen and J. Olsen ed., Balkema, 103-113.

- Staudtmeister K. and Schmidt T. (2000) Comparison of different methods for the estimation of primary stresses in rock salt mass with respect to cavern design. *Proc. 8th World Salt Symp.*, R.M. Geertman ed., **I**, 331-342.
- Staupendahl G. and Schmidt M.W. (1984) Field Investigations in the long-term deformational behavior of a 10,000 m³ cavity at the Asse salt mine. *Proc. 2nd Conf. Mech. Beh. of Salt*, Hannover, September 1984, Trans. Tech. Pub., Clausthal-Zellerfeld, Germany, 511-526.
- Texas Railroad Commission, *TAC Rules* § 3.95 and 3.97, available at <http://www.rrc.state.tx.us/>.
- Thiel W.R. (1993) Precision Methods for testing the integrity of solution mined underground storage caverns. *Proc. 7th Symp. on Salt*, Kakihane H., Hardy H.R. Jr, Hoshi T., Toyokura K. eds., Elsevier, **I**, 377-383.
- Thiel W.R. (1996) Summary of SMRI discussion cavern overflow shut down triggers, Houston, Texas, April 16, 1996 *SMRI Spring Meeting*, May 15 (available at SMRI).
- Thoms R.L. and Gehle R.M. (1988) Survey of existing caverns in US Salt Domes. *Proc. 2nd Conf. Mech. Beh. of Salt.*, Hannover, September 1984, Trans. Tech. Pub., Clausthal-Zellerfeld, Germany, 703-716.
- Thoms R.L. and Gehle R.M. (2000) A brief history of salt cavern use (keynote paper). *Proc. 8th World Salt Symp.*, R.M. Geertman ed., Elsevier, **I**, 207-214.
- Thoms R.L. and Kiddoo G. (1998) Guidelines for safety assessment of salt caverns. *Proc. Technical Class, SMRI Fall Meeting*, Roma, 113-140.
- Tomasko D., Elcock D., Veil J. and Caudle D. (1997) Risk analyses for disposing of nonhazardous oil field wastes in salt caverns. *Argonne National Laboratory, US Department of Energy*, Contract W-31-109-ENG-38.
- Van Sambeek LL. (1990) A simple method for modeling the pressure build up or flow of an abandoned solution well. *SMRI Spring Meeting*, Austin.
- Van Sambeek L.L. (1993) Evaluating cavern tests and surface subsidence using simple numerical models. *Proc. 7th Symp. on Salt*, Kakihane H., Hardy H.R. Jr, Hoshi T., Toyokura K. ed., Elsevier, **I**, 433-439.
- Vouille G., Tijani S.M. and de Grenier F. (1984) Experimental determination of the rheological behavior of Tersanne rock salt. *Proc. 1st Conf. Mech. Beh. of Salt*, Pennsylvania, November 1981, Trans. Tech. Pub., Clausthal-Zellerfeld, Germany, 407-420.
- Wallner M. (1988) Frac-pressure risk for cavities in rock salt. *Proc. 2nd Conf. Mech. Beh. of Salt*, Hannover, September 1984, Trans. Tech. Pub., Clausthal-Zellerfeld, Germany, 645-658.
- Wallner M. and Paar W.A. (1997) Risks of progressive pressure build up in a sealed cavern. *Proc. SMRI Fall Meeting*, El Paso, 177-188.
- Wallner M., Paar W.A. and Werner M. (2000) New results on cavern sealing and permeation processes. *Proc. SMRI Fall Meeting*, San Antonio, 127-135.
- Wallner M. and Eickemeier R. (2001) Subsidence and fractures caused by thermo-mechanical effects. *Proc. SMRI Spring Meeting*, Orlando, 363-371.
- Wassmann Th. H. (1983) Cavity utilization in the Netherlands. *Proc. 6th Symp. on Salt*, Schreiber B.C. and Harner H.L. eds., The Salt Institute, **II**, 191-201.
- Weidinger P., Blum W., Hampel A. and Hunsche U. (1998) Description of the creep of rock salt with composite model – I. Transient Creep. *Proc. 4th Conf. Mech. Beh. of Salt*, Montréal, June 1996, Trans. Tech. Pub., Clausthal-Zellerfeld, Germany, 277-285.
- Wilson B. (2002) Experts say hole apparent in 1993. *Hutchinson News*, Sunday February 17, hutchnews.com.
- You Th., Maisons Ch. and Valette M. (1994) Experimental procedures for the closure of the brine production caverns of the “Saline de Vauvert” site. *Proc. SMRI Fall Meeting*, Hannover.

Final manuscript received in December 2002