



HAL
open science

A new constitutive equation for elastoviscoplastic fluid flows

Pierre Saramito

► **To cite this version:**

| Pierre Saramito. A new constitutive equation for elastoviscoplastic fluid flows. 2006. hal-00109101v2

HAL Id: hal-00109101

<https://hal.science/hal-00109101v2>

Preprint submitted on 24 Oct 2006 (v2), last revised 2 Apr 2007 (v4)

HAL is a multi-disciplinary open access archive for the deposit and dissemination of scientific research documents, whether they are published or not. The documents may come from teaching and research institutions in France or abroad, or from public or private research centers.

L'archive ouverte pluridisciplinaire **HAL**, est destinée au dépôt et à la diffusion de documents scientifiques de niveau recherche, publiés ou non, émanant des établissements d'enseignement et de recherche français ou étrangers, des laboratoires publics ou privés.

A new constitutive equation for elastoviscoplastic fluid flows

Pierre Saramito ^a

^aLMC-IMAG, B.P. 53, 38041 Grenoble cedex 9, France

Abstract – From a thermodynamic theory, a new model for elastoviscoplastic fluid flow is presented. It extends the Bingham viscoplastic model and the Oldroyd viscoelastic model. Fundamental flows are studied: simple shear flow, uniaxial elongation and large amplitude oscillatory shear (LAOS). The complex moduli (G' , G'') are founded to be in qualitative agreement with experimental data for materials that present microscopic network structures and large scale rearrangements.

Keywords – non-Newtonian fluid; viscoelasticity; viscoplasticity; constitutive equation.

1. Introduction

Various fluids of practical interest, such as foams, droplets in emulsions or red cells in blood, present a viscoelastoplastic behavior : at low stress, the deformations are elastic and reversible while for a higher stress, and after a yield stress value, the behavior is plastic and irreversible. Despite numerous experimental works and some proposition of models, there is not yet an available elastoviscoplastic model that is (i) *objective*, i.e. independent of the observer, and that (ii) satisfies the *second principle of thermodynamics*.

The aim of the present article is to propose such a model. The first section presents the thermodynamical framework, the second section explicits the constitutive equation and the third section develops the complete set of equations governing such a flow. Finally, the last section studies its associated solution on three simple flows: a simple shear flow, an uniaxial elongation and an oscillatory shear flow.

Three main dimensionless numbers appear : We , the Weissenberg number, that expresses memory effects of the fluid, Bi , the Bingham number, that expresses the yield stress mechanism associated to plasticity, and finally Re , the classical Reynolds number. The proposed model permits to recover the Bingham's viscoplastic model for $We = 0$, the Oldroyd's viscoelastic model for $Bi = 0$, and the Navier-Stokes equations for $We = Bi = 0$.

2. Thermodynamical framework

The state of the system is described by using two independent variables : the total deformation tensor ε and an internal variable, the elastic deformation tensor ε_e . We have $\varepsilon = \varepsilon_e + \varepsilon_m$ where ε_m represents

Email address: Pierre.Saramito@imag.fr (Pierre Saramito).

the plastic deformation tensor. The generalized standard materials [3] are characterized by the existence of a free energy function \mathcal{E} and a potential of dissipation \mathcal{D} , that are both convex functions of their arguments. The proposed model that combines viscoelasticity and viscoplasticity, is represented by a rheological scheme on Fig. 1 and writes:

$$\begin{aligned}\mathcal{E}(\varepsilon, \varepsilon_e) &= \mu |\varepsilon_e|^2, \\ \mathcal{D}(\dot{\varepsilon}, \dot{\varepsilon}_e) &= \varphi(\dot{\varepsilon}) + \varphi_m(\dot{\varepsilon} - \dot{\varepsilon}_e)\end{aligned}\quad (1)$$

where $\mu > 0$ is the elasticity parameter and where $|\cdot|$ denotes the matrix norm, defined by a double contraction of indices : $|\varepsilon_e|^2 = \varepsilon_e : \varepsilon_e$. The functions φ and φ_m are expressed by :

$$\varphi(\dot{\varepsilon}) = \begin{cases} \eta |\dot{\varepsilon}|^2 & \text{when } \text{tr } \dot{\varepsilon} = 0 \\ +\infty & \text{otherwise} \end{cases} \quad \varphi_m(\dot{\varepsilon}_m) = \begin{cases} \eta_m |\dot{\varepsilon}_m|^2 + \tau_0 |\dot{\varepsilon}_m| & \text{when } \text{tr } \dot{\varepsilon}_m = 0 \\ +\infty & \text{otherwise} \end{cases} \quad (2)$$

The φ function expresses the incompressible viscous behavior at macroscopic level and is associated to a macroscopic viscosity $\eta > 0$ while the φ_m function expresses the viscoplastic behavior at microscopic level, by using a microscopic viscosity $\eta_m > 0$, acting on continuous modification of the network links. and also a yield stress value $\tau_0 \geq 0$. When the stress becomes higher than this value, some topological modifications appear in the network of contacts. This model satisfies the second principle of thermodynamics: in the framework of generalized standard materials (cf. [3] and also [11,2]), this property is a direct consequence of the convexity of both \mathcal{E} and \mathcal{D} .

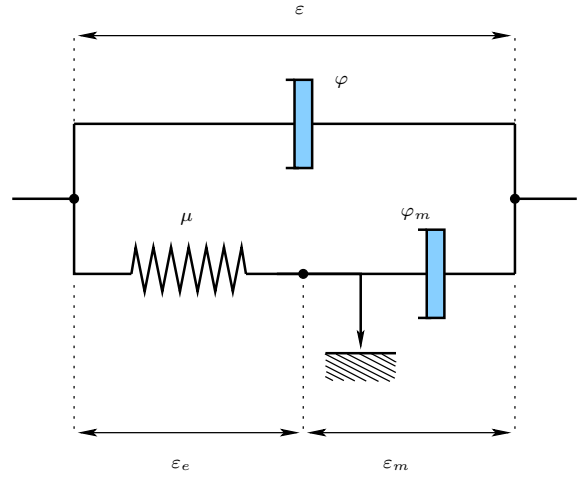

Figure 1. The rheological model.

Let Ω be a bounded domain of \mathbb{R}^N , where $N = 1, 2, 3$. Since both φ and φ_m are non-linear and non-differentiable, the following manipulations involve subdifferential calculus from convex analysis. The material constitutive laws write:

$$\sigma_{\text{tot}} \in \frac{\partial \mathcal{E}}{\partial \varepsilon} + \frac{\partial \mathcal{D}}{\partial \dot{\varepsilon}} \quad \text{and} \quad 0 \in \frac{\partial \mathcal{E}}{\partial \varepsilon_e} + \frac{\partial \mathcal{D}}{\partial \dot{\varepsilon}_e}$$

where σ_{tot} is the Cauchy's stress tensor. Using definition (1) of \mathcal{E} and \mathcal{D} , we get:

$$\sigma_{\text{tot}} \in \partial \varphi(\dot{\varepsilon}) + \partial \varphi_m(\dot{\varepsilon} - \dot{\varepsilon}_e) \quad \text{and} \quad 0 \in 2\mu \varepsilon_e - \partial \varphi_m(\dot{\varepsilon} - \dot{\varepsilon}_e) \quad (3)$$

The combination of the two previous relations leads to $\sigma_{\text{tot}} - 2\mu \varepsilon_e \in \partial \varphi(\dot{\varepsilon})$. Then, by using expression (A.3) of $\partial \varphi$ from the technical annex, and by introducing the pressure field p , we get the following expression of the total stress tensor: $\sigma_{\text{tot}} = -p.I + 2\eta \dot{\varepsilon} + 2\mu \varepsilon_e$ when $\text{tr}(\dot{\varepsilon}) = 0$. Then, the second relation in (3) is equivalent to $\dot{\varepsilon} - \dot{\varepsilon}_e \in \partial \varphi_m^*(2\mu \varepsilon_e)$ where φ_m^* is the dual of φ_m . Let us introduce the elastic stress tensor $\tau = 2\mu \varepsilon_e$. The expression (A.2) of $\partial \varphi_m^*$ in annex yields:

$$\lambda \dot{\tau} + \max \left(0, \frac{|\tau_d| - \tau_0}{|\tau_d|} \right) \tau = 2\eta_m \dot{\varepsilon} \quad (4)$$

where $\lambda = \eta_m/\mu$ is the relaxation time and $\tau_d = \tau - \frac{1}{N} \text{tr}(\tau) I$ denotes the deviatoric part of τ .

4. The system of equations

Since the material is considered in large deformations, we choose to use the Eulerian mathematical framework, more suitable for fluids flows computations. We assume that $\dot{\epsilon} = D(\mathbf{v}) = (\nabla \mathbf{v} + \nabla \mathbf{v}^T)/2$ is the rate of deformation, while the material derivative $\dot{\tau}$ of tensor τ in the Eulerian framework is expressed by the Gordon-Schowalter's derivative : $\dot{\tau} = \frac{\square}{\partial t} \tau + \mathbf{v} \cdot \nabla \tau + \tau W(\mathbf{v}) - W(\mathbf{v})\tau - a(\tau D(\mathbf{v}) + D(\mathbf{v})\tau)$ where $W(\mathbf{v}) = (\nabla \mathbf{v} - \nabla \mathbf{v}^T)/2$ is the vorticity tensor. The material parameter $a \in [-1, 1]$ is associated to the Gordon-Schowalter's derivative. When $a = 0$ we obtain the Jaumann derivative of tensors, while $a = 1$ and $a = -1$ are associated to the upper and the lower convected derivatives, respectively.

The elastoviscoplastic fluid is then described by a set of three equations associated to three unknowns (τ, \mathbf{v}, p) : the differential equation (4) is completed with the conservation of momentum and mass:

$$\begin{cases} \lambda \frac{\square}{\tau} + \max\left(0, \frac{|\tau_d| - \tau_0}{|\tau_d|}\right) \tau - 2\eta_m D(\mathbf{v}) = 0 \\ \rho \left(\frac{\partial \mathbf{v}}{\partial t} + \mathbf{v} \cdot \nabla \mathbf{v}\right) - \mathbf{div}(-pI + 2\eta D(\mathbf{v}) + \tau) = \mathbf{f} \\ \mathbf{div} \mathbf{v} = 0 \end{cases}$$

where ρ denotes the constant density and \mathbf{f} a known external forces, such as the gravity. These equations are completed by some suitable initial and boundaries conditions in order to close the system. For instance the initial conditions $\tau(t=0) = \tau_0$ and $\mathbf{v}(t=0) = \mathbf{v}_0$ and the boundary condition $\mathbf{v} = \mathbf{v}_\Gamma$ on the boundary $\partial\Omega$ are convenient. The total Cauchy stress tensor writes $\sigma_{\text{tot}} = -pI + 2\eta D(\mathbf{v}) + \tau$. Notice that when $\tau_0 = 0$ the model reduces to the usual viscoelastic Oldroyd model [5,8] and when $\lambda = 0$ it reduces to the viscoplastic Bingham model [1,7]. When both $\tau_0 = 0$ and $\lambda = 0$ the fluid is Newtonian and the set of equations reduces to the classical Navier-Stokes equations associated to a total viscosity $\eta_0 = \eta + \eta_m$. Conversely, when both $\tau_0 \neq 0$ and $\lambda \neq 0$ the fluid is elastoviscoplastic.

Dimensionless formulation – Let us introduce some classical dimensionless numbers:

$$We = \frac{\lambda U}{L}, \quad Bi = \frac{\tau_0 L}{\eta_0 U} \quad \text{and} \quad Re = \frac{\rho U L}{\eta_0}$$

where U and L are some characteristic velocity and length of the flow, respectively. We also use the retardation parameter $\alpha = \eta_m/\eta_0$. The problem reduces to find some dimensionless fields, also denoted by (τ, \mathbf{v}, p) such that:

$$\begin{cases} We \frac{\square}{\tau} + \max\left(0, \frac{|\tau_d| - Bi}{|\tau_d|}\right) \tau - 2\alpha D(\mathbf{v}) = 0 \\ Re \left(\frac{\partial \mathbf{v}}{\partial t} + \mathbf{v} \cdot \nabla \mathbf{v}\right) - \mathbf{div}(-pI + 2(1 - \alpha)D(\mathbf{v}) + \tau) = \mathbf{f} \\ \mathbf{div} \mathbf{v} = 0 \end{cases} \quad (5)$$

where \mathbf{f} denotes some known dimensionless vector field. These equations are completed by the initial and boundaries conditions.

5. Examples

5.1. Uniaxial elongation

The fluid is at the rest at $t = 0$ and a constant elongational rate $\dot{\epsilon}_0$ is applied: the Weissenberg number is $We = \lambda\dot{\epsilon}_0$ and the Bingham number $Bi = \tau_0/(\eta_0\dot{\epsilon}_0)$. All quantities presented in this paragraph are dimensionless.

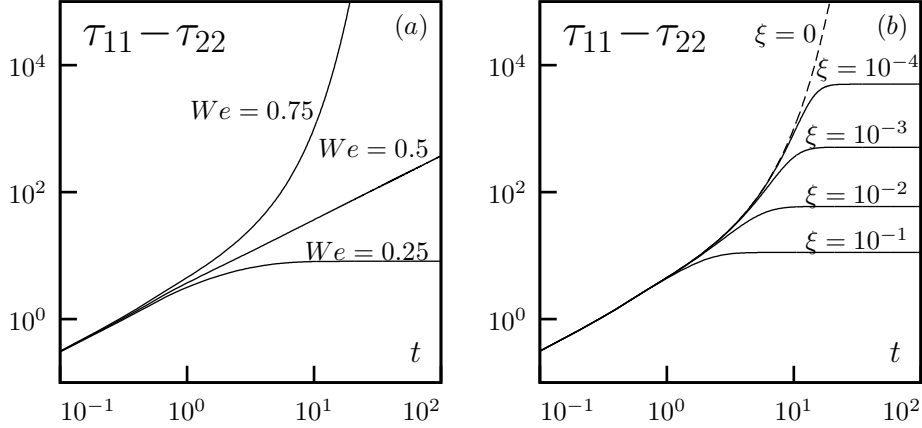

Figure 2. Dimensionless first normal stress difference $\psi = \tau_{11} - \tau_{22}$ for uniaxial elongation when $Bi=1$, $a=1$ and $\alpha=1$: (a) influence of We for $\xi=0$; (b) influence of ξ for $We=0.75$.

The flow is tridimensional and the dimensionless velocity gradient writes $\nabla\mathbf{v} = \text{diag}(1, -1/2, -1/2)$. The problem reduces to find τ_{11}, τ_{22} and τ_{33} such that

$$\begin{cases} We \frac{d\tau_{11}}{dt} + (\kappa - 2aWe)\tau_{11} = 2\alpha \\ We \frac{d\tau_{kk}}{dt} + (\kappa + aWe)\tau_{kk} = -\alpha, \quad k = 2, 3 \end{cases}$$

with the initial condition $\tau(t=0) = 0$ and where $\kappa = \max(0, 1 - Bi/|\tau_d|)$. As above, since $\tau(0) = 0$ and $\tau(t)$ is continuous, there exists $t_0 > 0$ such that when $t \in [0, t_0]$ we have $|\tau_d| \leq Bi$ and thus $\kappa = 0$: this is the linear flow regime. The eigenvalues of the system are $-2aWe$ and aWe . For $t > t_0$, the case $\kappa > 0$ occurs. Since $\kappa \leq 1$, when $aWe > 1/2$ the solution is no more bounded, as shown on Fig. 2.a that plots the dimensionless first normal stress difference $\psi = \tau_{11} - \tau_{22}$. This drawback is still true when $Bi = 0$, i.e. for the Oldroyd viscoelastic model. In the context of viscoelastic models, some alternate constitutive equations that extends the Oldroyd model has been proposed. Let us consider the following constitutive equation:

$$We \overset{\square}{\tau} + (1 + \xi \text{tr} \tau) \max\left(0, \frac{|\tau_d| - Bi}{|\tau_d|}\right) \tau - 2\alpha D(\mathbf{v}) = 0 \quad (6)$$

where $\xi \geq 0$ is a new material parameter. For $Bi = 0$ we obtain the viscoelastic Phan-Thien and Tanner model (see e.g. [6,9]). For $\xi = 0$ we obtain the previous elastoviscoplastic model (5) while for any $\xi > 0$ the solution remains bounded, as shown on Fig. 2.b for $We = 0.75$.

5.2. Simple shear flow

The fluid is at the rest at $t = 0$ and a constant shear rate $\dot{\gamma}_0$ is applied: the Weissenberg number is $We = \lambda\dot{\gamma}_0$ and the Bingham number $Bi = \tau_0/(\eta_0\dot{\gamma}_0)$.

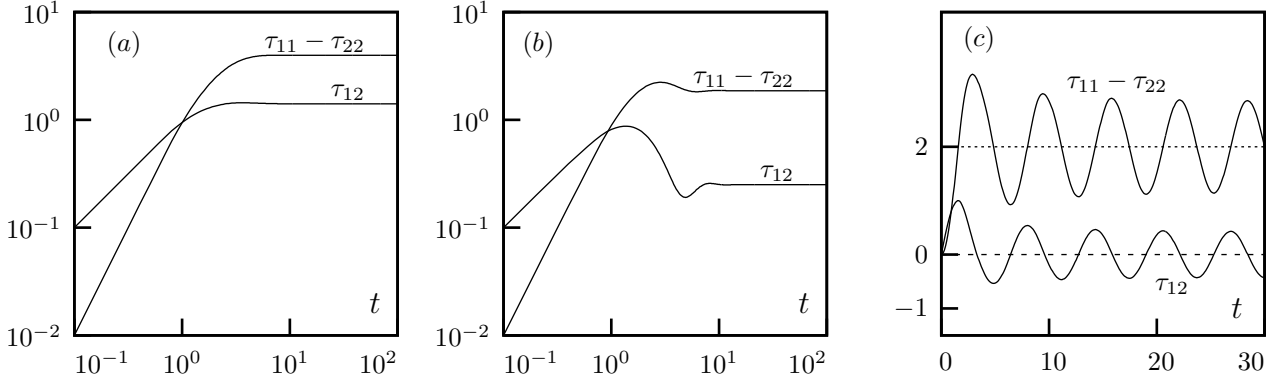

Figure 3. Simple shear flow for $We = 1$ and $\alpha = 8/9$: (a) $a = 1$ and $Bi = 1$; (b) $a = 0$ and $Bi = 1$; (c) $a = 0$ and $Bi = 2$.

The flow is bidimensional and the dimensionless velocity gradient is constant: $\nabla \mathbf{v} = ([0, 1]; [0, 0])$. The problem reduces to find τ_{11}, τ_{22} and τ_{12} , from \mathbb{R}^+ to \mathbb{R} , such that

$$We \frac{d}{dt} \begin{pmatrix} \tau_{11} \\ \tau_{22} \\ \tau_{12} \end{pmatrix} + We \begin{pmatrix} 0 & 0 & -(1+a) \\ 0 & 0 & 1-a \\ \frac{1-a}{2} & -\frac{1+a}{2} & 0 \end{pmatrix} \begin{pmatrix} \tau_{11} \\ \tau_{22} \\ \tau_{12} \end{pmatrix} + \kappa \begin{pmatrix} \tau_{11} \\ \tau_{22} \\ \tau_{12} \end{pmatrix} = \begin{pmatrix} 0 \\ 0 \\ \alpha \end{pmatrix} \quad (7)$$

with the initial condition $\tau(0) = 0$ and where $\kappa = \max(0, 1 - Bi/|\tau_d|)$ and $|\tau_d|^2 = (1/2)(\tau_{11} - \tau_{22})^2 + 2\tau_{12}^2$. Let $\psi = \tau_{11} - \tau_{22}$ be the dimensionless normal stress difference. Then $\tau_{11} = \frac{1+a}{2}\psi$ and $\tau_{22} = -\frac{1-a}{2}\psi$. The solution (τ_{12}, ψ) is represented on Fig. 3. Since $\tau(0) = 0$ and $\tau(t)$ is continuous, there exists $t_0 > 0$ such that when $t \in [0, t_0]$ we have $|\tau_d| \leq Bi$ and thus $\kappa = 0$: this is the linear flow regime. The eigenvalues of the system are 0 and $\pm i\sqrt{1-a^2}$. At $t = t_0$, $|\tau_d|$ reaches Bi . Then, for $t > t_0$, the non-linear factor $\kappa > 0$ occurs: the corresponding term amortizes the growth of the solution, that remains bounded. When $a = 1$ (see Fig. 3.a, where $\tau_{22} = 0$) and when $|a| < 1$ and Bi (see Fig. 3.b, where $\tau_{22} = -\tau_{11}$) is small enough, the solution tends to a constant. Remark the overshoot of the solution when $|a| < 10$ (Fig. 3.b). When $|a| < 1$ and Bi becomes large, instabilities appear, while the solution remains bounded (Fig. 3.c).

Notice that the dimensionless steady shear viscosity η_s/η_0 coincide with $\sigma_{12} = 1 - \alpha + \tau_{12}$ the dimensionless shear stress. When the solution becomes stationary, let us observe the dimensionless steady shear viscosity η_s/η_0 as a function of We on Fig. 4. The material presents a shear thinning character. For large We , the shear viscosity tends to a plateau when $\xi = 0$ (Fig. 4.a) and decreases monotonically when $\xi > 0$ (Fig. 4.b). This shear thinning behavior is more pronounced when Bi increases: the value of Bi controls the plateau at small values of We .

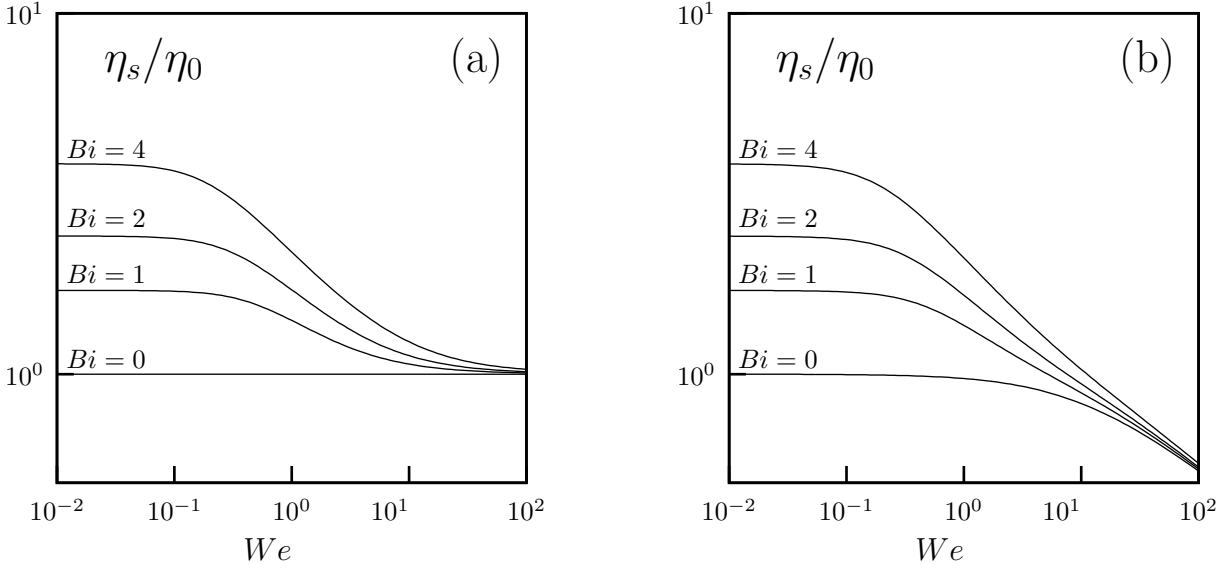

Figure 4. Shear viscosity for $a = 1$, $\alpha = 1$ and (a) $\xi = 0$; (b) $\xi = 0.015$.

5.3. Periodic shear flow

An oscillatory shear flow is applied: the imposed shear strain is $\gamma_0 \sin(\omega t)$ and the shear rate becomes $\gamma_0 \omega \cos(\omega t)$. The Weissenberg number is defined by $We = \lambda \omega$ and the Bingham number by $Bi = \tau_0 / (\eta_0 \gamma_0 \omega)$.

The flow is bidimensional and the velocity gradient is periodic: $\nabla \mathbf{v}(t) = ([0, \cos t]; [0, 0])$. The problem reduces to find τ_{11}, τ_{22} and τ_{12} , from \mathbb{R}^+ to \mathbb{R} , such that

$$\left\{ \begin{array}{l} We \frac{d}{dt} \begin{pmatrix} \tau_{11} \\ \tau_{22} \\ \tau_{12} \end{pmatrix} + \mathcal{F}(t, \tau) = \begin{pmatrix} 0 \\ 0 \\ \alpha \cos t \end{pmatrix} \quad \text{in }]0, 2\pi[\\ \tau(0) = \tau(2\pi) \end{array} \right. \quad (8)$$

where

$$\mathcal{F}(t, \tau) = We \cos(t) \mathcal{A}_a \begin{pmatrix} \tau_{11} \\ \tau_{22} \\ \tau_{12} \end{pmatrix} + \kappa \begin{pmatrix} \tau_{11} \\ \tau_{22} \\ \tau_{12} \end{pmatrix}$$

and $\kappa = \max(0, 1 - Bi/|\tau_d|)$ and $|\tau_d|^2 = (1/2)(\tau_{11} - \tau_{22})^2 + 2\tau_{12}^2$.

5.3.1. The solution for $Bi = 0$

The case $Bi = 0$ is asymptotically reached when the amplitude γ_0 becomes large. The material behaves as a viscoelastic fluid and the system reduces to:

$$\left\{ \begin{array}{l} We \frac{d\tau_{11}}{dt} - We(1+a) \cos(t) \tau_{12} + \tau_{11} = 0 \\ We \frac{d\tau_{22}}{dt} + We(1-a) \cos(t) \tau_{12} + \tau_{22} = 0 \\ We \frac{d\tau_{12}}{dt} + \frac{We \cos(t)}{2} ((1-a)\tau_{11} - (1+a)\tau_{22}) + \tau_{12} = \alpha \cos(t) \end{array} \right.$$

together with periodic boundary condition $\tau(0) = \tau(2\pi)$. By introducing the first normal stress difference $\psi = \tau_{11} - \tau_{22}$, the system can be rewritten in a more compact form:

$$\left\{ \begin{array}{l} We \frac{d\psi}{dt} + \psi = 2We \cos(t) \tau_{12} \\ We \frac{d\tau_{12}}{dt} + \tau_{12} = \alpha \cos(t) - \frac{We(1-a^2) \cos(t)}{2} \psi \\ \psi(0) = \psi(2\pi) \text{ and } \tau_{12}(0) = \tau_{12}(2\pi) \\ \tau_{11} = \frac{1+a}{2} \psi \text{ and } \tau_{22} = -\frac{1-a}{2} \psi \end{array} \right.$$

When $a = \pm 1$ the system admits an explicit solution:

$$\psi(t) = \frac{\alpha We}{(1+We^2)(1+4We^2)} ((1+2We^2) \cos(2t) + 3We \sin(2t) + 1 + 4We^2) \quad (9)$$

$$\tau_{12}(t) = \frac{\alpha}{1+We^2} (\cos(t) + We \sin(t)) \quad (10)$$

Otherwise, when $|a| < 1$, the solution has no explicit form to our knowledge.

5.3.2. The solution for large Bi

The case $Bi \rightarrow +\infty$ is reached when the amplitude γ_0 becomes small. The material behaves as an elastic solid. Moreover, there exists a finite value $Bi_c > 0$ such that when $Bi > Bi_c$ then the solution satisfies $|\tau_d| < Bi$. In that case, the system reduces to:

$$\left\{ \begin{array}{l} We \frac{d\tau_{11}}{dt} - We(1+a) \cos(t) \tau_{12} = 0 \\ We \frac{d\tau_{22}}{dt} + We(1-a) \cos(t) \tau_{12} = 0 \\ We \frac{d\tau_{12}}{dt} + \frac{We \cos(t)}{2} ((1-a)\tau_{11} - (1+a)\tau_{22}) = \alpha \cos(t) \end{array} \right.$$

together with the periodic boundary condition $\tau(0) = \tau(2\pi)$. Let $\psi = \tau_{11} - \tau_{22}$. Combining the previous equations, we get

$$\left\{ \begin{array}{l} We \frac{d\psi}{dt} = 2We \cos(t) \tau_{12} \\ We \frac{d\tau_{12}}{dt} = \alpha \cos(t) - \frac{We(1-a^2) \cos(t)}{2} \psi \\ \psi(0) = \psi(2\pi) \text{ and } \tau_{12}(0) = \tau_{12}(2\pi) \\ \tau_{11} = \frac{1+a}{2} \psi \text{ and } \tau_{22} = -\frac{1-a}{2} \psi \end{array} \right.$$

When $a = \pm 1$ the solution is known explicitly:

$$\psi(t) = \frac{\alpha(c - \cos(2t))}{2We} \quad (11)$$

$$\tau_{12}(t) = \frac{\alpha \sin(t)}{We} \quad (12)$$

where c is an arbitrary constant. In that case $|\tau_d(t)|$ is maximum for $t = \pi/2$ when $c \geq 0$ and $t = -\pi/2$ when $c \leq 0$. We have:

$$\max_{t \in [0, 2\pi]} |\tau_d(t)| = \frac{\alpha}{2\sqrt{2}We} ((1 + |c|)^2 + 16)^{1/2}$$

Let

$$Bi_c := \sqrt{\frac{17}{8}} \frac{\alpha}{We}$$

Then, when $Bi \geq Bi_c$, there exists a periodic solution $\tau(t)$ for all t in $[0, 2\pi]$ such that $|\tau_d(t)| \leq Bi$ in $[0, 2\pi]$ and this solution is expressed by (11)-(12).

5.3.3. The solution for $Bi \in]0, Bi_c[$

Problem (8) is approximated by using a centered second order scheme:

$$\begin{cases} \frac{We}{2\Delta t} \begin{pmatrix} \tau_{11}^{n+1} - \tau_{11}^{n-1} \\ \tau_{22}^{n+1} - \tau_{22}^{n-1} \\ \tau_{12}^{n+1} - \tau_{12}^{n-1} \end{pmatrix} + \mathcal{F}(t_n, \tau^n) = \begin{pmatrix} 0 \\ 0 \\ \alpha \cos t_n \end{pmatrix} \\ \tau_0 = \tau_N \end{cases} \quad (13)$$

with $t_n = 2\pi n/N$, $n = 0 \dots N$, $\Delta t = 2\pi/N$ and $\tau^n \approx \tau(t_n)$. This is a N by N non-linear system of equations that we solve by using a non-linear Gauss-Seidel iterative algorithm. We use $N = 1000$ points in the $[0, 2\pi]$ interval, and iterations are stopped when the maximal residual term in the discrete non-linear problem (13) becomes lower than 10^{-12} . Fig. 5 shows the solution τ_{12} and τ_{11} (while $\tau_{22} = 0$) for $a = 1$, $Bi = 3$, $\alpha = 1$, $\xi = 0$, and $We = 0.1, 0.05$ and 0.025 . When $a = 0$ the components τ_{12} and τ_{11} are comparable up to a slight variation, while $\tau_{22} = -\tau_{11}$, and the corresponding solution is not represented.

5.3.4. Fourier analysis

The solution $\sigma_{12} = (1 - \alpha)\dot{\gamma} + \tau_{12}$ expands as:

$$\sigma_{12}(t) = \sum_{k \geq 1} a_k \sin(kt) + b_k \cos(kt)$$

where the coefficients are expressed by:

$$a_k = \frac{1}{\pi} \int_0^{2\pi} \sigma_{12}(t) \sin(kt) dt \quad \text{and} \quad b_k = \frac{1}{\pi} \int_0^{2\pi} \sigma_{12}(t) \cos(kt) dt$$

When the response is linear we have $a_k = b_k = 0$ for all $k \geq 2$. There are two cases when this situation occurs: when $Bi = 0$ while the material behaves as a viscoelastic fluid, and when $Bi \rightarrow +\infty$ while it behaves as an elastic solid. Otherwise, only odd harmonics appear. In [4], the authors propose large amplitude oscillatory shear as a way to classify complex fluids. Following this approach, we observe on Fig. 7 that the third harmonic contributes of about 20% of the first harmonic, and higher harmonics decay very fast. See also [12, p. 74] for a comparable observation, based on a comparison between experimental data on a linear high-density polyethylene melt and several theoretical models. See also Fig. 11 in [4]

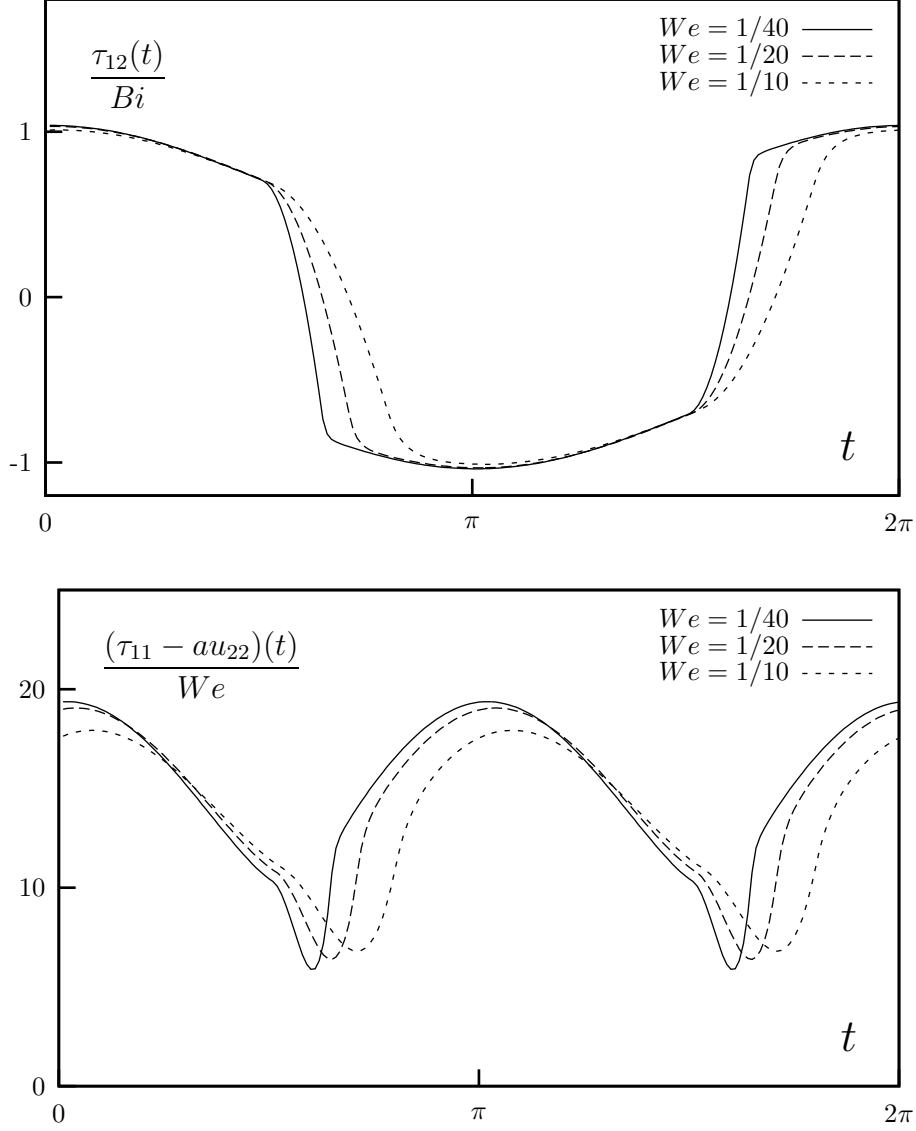

Figure 5. Periodic shear flow: influence of $We = 0.1, 0.05, 0.025$ for $\xi=0$: (top) τ_{12}/Bi ; (bottom) τ_{11}/We .

for a similar observation based on experimental data for a xanthan gum solution. Therefore, the moduli obtained from the first harmonic via Fourier transformation analysis are not substantially different from the moduli calculated neglecting higher harmonics, as in the linear regime. By extension to the linear regimes, let us introduce the in-phase moduli G' and the out-of-phase moduli G'' : there are related to the first Fourier coefficients by $G' = a_1$ and $G'' = b_1$. When $Bi \geq Bi_c$, the material behaves as an elastic solid, the regime is linear and the solution is independent of Bi . The corresponding values of G' and G'' are denoted by G'_e and G''_e . When $a = \pm 1$, from (12), we have

$$G'_e = \alpha/We \quad \text{and} \quad G''_e = 1 - \alpha$$

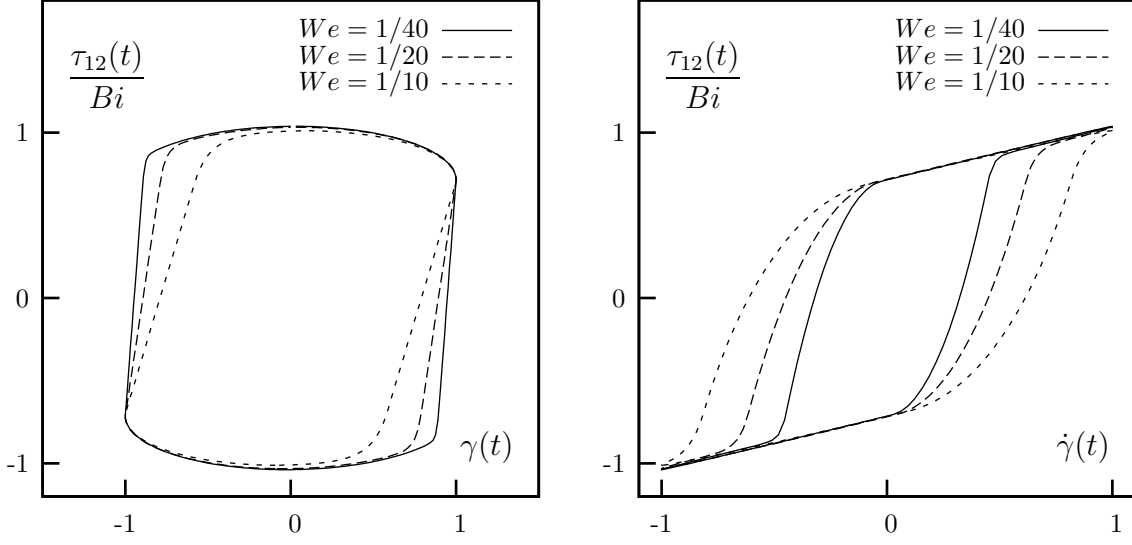

Figure 6. Lissajous plots: influence of $We = 0.1, 0.05, 0.025$ for $\xi = 0$: (left) τ_{12}/Bi versus $\gamma(t) = \sin(t)$; (right) τ_{12}/Bi versus $\dot{\gamma}(t) = \cos(t)$.

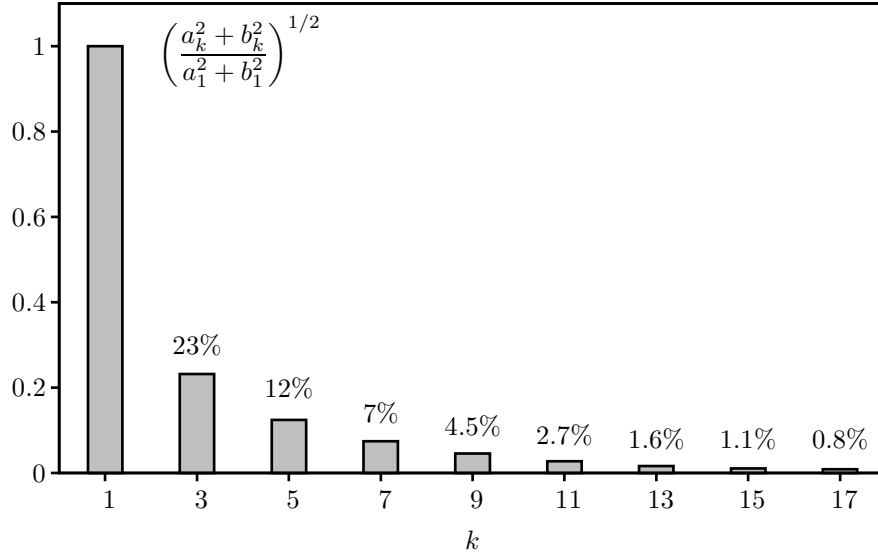

Figure 7. Periodic shear flow: intensities of the harmonics normalized by the intensity of the fundamental frequency: $We = 1/40$, $Bi = 3$, $a = 1$ and $\alpha = 8/9$.

Conversely, when Bi vanishes, the material behaves as a viscoelastic fluid: the constitutive equation is also linear and the solution is expressed by (10). The corresponding values of G' and G'' are denoted by G'_{ve} and G''_{ve} :

$$G'_{ve} = \frac{\alpha We}{1 + We^2} \quad \text{and} \quad G''_{ve} = 1 - \frac{\alpha We^2}{1 + We^2}$$

In the non-linear case, the moduli (G' , G'') are computed by using the solution $(\tau^n)_{0 \leq n \leq N}$ of the approximate problem (13):

$$G' \approx \frac{2}{N} \sum_{n=1}^N \tau_{12}^n \sin(t_n) \quad \text{and} \quad G'' \approx 1 - \alpha + \frac{2}{N} \sum_{n=1}^N \tau_{12}^n \cos(t_n)$$

Fig. 8 plots G' and G'' versus the dimensionless number $Bi^{-1} = \gamma_0 \eta_0 \omega / \tau_0$. This is a dimensionless version of the moduli plots since most figures in the literature are based on the representation of the moduli versus the amplitude γ_0 . Only G'' shows an overshoot: this behavior matches the type III of the

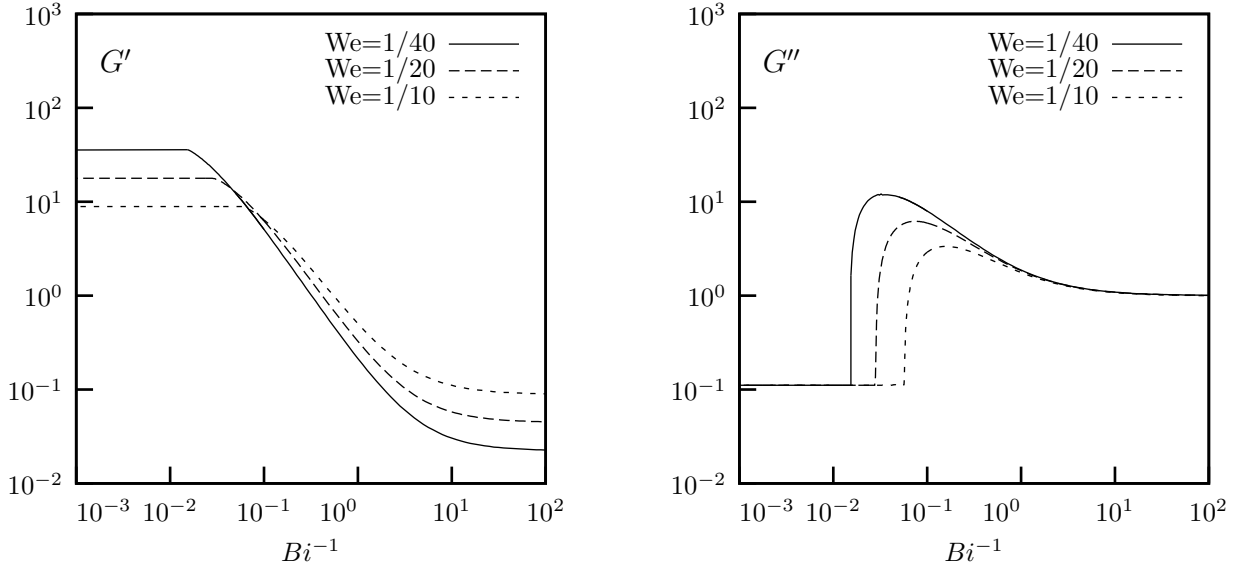

Figure 8. Periodic shear flow: moduli versus Bi^{-1} for $a = 1$: (left) G' ; (right) G'' .

classification introduced in [4] when using large amplitude oscillatory shear: many materials that present such a behavior are listed on page 61. See also Fig. 7.b of this reference for the (G', G'') plot of a xanthan gum 4% solution. The micro-structure of this class of materials is characterized by a network of links that develops some complex structures. When an external strain is imposed, the complex network structure is destroyed by large deformation over a critical strain. In [10], based on a network model, the authors explain the overshoot of G'' in term of the balance between the formation and the destruction of the network junctions.

Conclusion

A new model for elastoviscoplastic fluid flows that is objective and satisfies the second principle of thermodynamics is proposed in (5). A variant of the constitutive equation is also introduced in (6) in order to enforce finite extensional properties of the material. Large amplitude oscillatory shear (LAOS) has been performed and complex moduli (G' , G'') are qualitatively in good agreement with experimental data for many materials that present microscopic complex network structures with large rearrangements. The model is a good candidate for numerical simulation of elastoviscoplastic in multidimensional geometries:

future works will perform such computations and compare it with experimental data measurements on complex geometries.

References

- [1] E. C. Bingham. *Fluidity and Plasticity*. Mc Graw-Hill, New-York, 1922.
- [2] R. Glowinski and P. Le Tallec. *Augmented Lagrangian and Operator Splitting Method in Non-Linear Mechanics*. SIAM Studies in Applied Mathematics, 1989.
- [3] B. Halphen and Q. S. NGuyen. Sur les matériaux standard généralisés. *J. Méca.*, 14:39–63, 1975.
- [4] K. Hyun, S. H. Kim, K. H. Ahn, and S. J. Lee. Large amplitude oscillatory shear as a way to classify the complex fluids. *J. non-Newtonian Fluid Mechanics*, 107:51–65, 2002.
- [5] J. G. Oldroyd. On the formulation of rheological equations of states. *Proc. Roy. Soc. London, A* 200:523–541, 1950.
- [6] N. Phan-Thien and R. I. Tanner. A new constitutive equation derived from network theory. *J. Non Newtonian Fluid Mech.*, 2:353–365, 1977.
- [7] N. Roquet and P. Saramito. An adaptive finite element method for Bingham fluid flows around a cylinder. *Comput. Appl. Meth. Mech. Engrg.*, 192(31-32):3317–3341, 2003.
- [8] P. Saramito. Operator splitting for viscoelastic fluid with a differential constitutive law. *C. R. Acad. Sci. Paris, Série II*, t. 319, No. 3:267–270, 1994.
- [9] P. Saramito. Efficient simulation of nonlinear viscoelastic fluid flows. *J. Non Newtonian Fluid Mech.*, 60:199–223, 1995.
- [10] H. G. Sim, K. H. Ahn, and S. J. Lee. Large amplitude oscillatory shear behavior of complex fluids investigated by a network model: a guideline for classification. *J. non-Newtonian Fluid Mechanics*, 112:237–250, 2003.
- [11] P. Le Tallec. *Numerical analysis of viscoelastic problems*. Masson, France, 1990.
- [12] P. Wapperom, A. Leygue, and R. Keunings. Numerical simulation of large amplitude oscillatory shear of a high-density polyethylene melt using the MSF model. *J. Non-Newtonian Fluid Mech.*, 130:63–76, 2005.

Appendix A. Subdifferential calculus

A.1. *The φ_m function* – The subgradient $\partial\varphi_m$, as introduced in (2), is defined for any tensor D by:

$$\begin{aligned}\partial\varphi_m(D) &= \{\tau, \tau : (H - D) \leq \varphi_m(H) - \varphi_m(D), \forall H\} \\ &= \{\tau, j_m(D) \leq j_m(H), \forall H \text{ with } \text{tr}(H) = 0 \text{ and } \text{tr}(D) = 0\}\end{aligned}$$

with the notation $j_\tau(H) = \eta_m|H|^2 + \tau_0|H| - \tau : H$. When the minimizer D of j_τ over the kernel of the trace operator $\text{Ker}(\text{tr})$ is non vanishing, it satisfies, from the theory of Lagrange multipliers:

$$\nabla j_\tau(D) - p \cdot \nabla \text{tr} = 0 \quad \text{and} \quad \text{tr}(D) = 0$$

where p is the Lagrange multiplier. Then $2\eta_m D + \tau_0 \frac{D}{|D|} - \tau - p \cdot I = 0$ and $\text{tr}(D) = 0$. Thus the subgradient finally writes:

$$\partial\varphi(D) = \begin{cases} \{\tau, |\tau_d| \leq \tau_0\} & \text{when } D = 0 \\ \left\{ \tau, \tau = -p \cdot I + 2\eta_m D + \tau_0 \frac{D}{|D|} \right\} & \text{when } D \neq 0 \text{ and } \text{tr}(D) = 0 \\ \emptyset & \text{otherwise} \end{cases} \quad (\text{A.1})$$

where τ_d denotes the deviatoric part of τ . The dual φ_m^* of φ_m is then characterized by the Fenchel identity, that is, for any $\tau \in \partial\varphi_m(D)$, by $\varphi_m^*(\tau) = \tau : D - \varphi_m(D)$. Moreover, $\tau \in \partial\varphi_m(D)$ is equivalent to $D \in \partial\varphi_m^*(\tau)$. From $\tau + p.I = (2\eta_m + \tau_0/|D|)D$ we get $|\tau_d| = 2\eta_m|D| + \tau_0$ and thus $|D| = (|\tau_d| - \tau_0)/(2\eta_m)$. Finally:

$$\partial\varphi_m^*(\tau) = \left\{ D, D = \frac{1}{2\eta_m} \max\left(0, \frac{|\tau_d| - \tau_0}{|\tau_d|}\right) \tau_d \right\} \quad (\text{A.2})$$

A.2. The φ function – The function φ , as introduced in (2), is a particular case of φ_m with $\eta_m := \eta$ and $\tau_0 := 0$. From (A.1), the subgradient writes:

$$\partial\varphi(D) = \begin{cases} \{\tau, \tau = -p.I + 2\eta D\} & \text{when } \text{tr}(D) = 0 \\ \emptyset & \text{otherwise} \end{cases} \quad (\text{A.3})$$