

# Control of Fuel Cell/Supercapacitors Hybrid Power Sources

Phatiphat Thounthong\*, Stéphane Raël, and Bernard Davat

Institut National Polytechnique de Lorraine (INPL), GREEN, CNRS: UMR 7037

2, Avenue de la Forêt de Haye, 54516 Vandœuvre-lès-Nancy, France

Phone: +33 383 59 56 54, Fax: +33 383 59 56 53

\* [Phatiphat.Thounthong@ensem.inpl-nancy.fr](mailto:Phatiphat.Thounthong@ensem.inpl-nancy.fr), [thounthong@yahoo.com](mailto:thounthong@yahoo.com)

**Abstract** – This paper presents a control strategy for employing PEM fuel cell, known as slow dynamic device, as main power source and supercapacitors, known as high dynamic storage elements, as auxiliary power source for dc distributed system. The main point is to regulate the dc bus, and the important constraint is to avoid speedy operation of fuel cell current. Therefore, fuel cell is simply operating in almost steady state conditions in order to ensure a good synchronization between fuel (hydrogen and oxygen) flow and fuel cell current and to lessen mechanical stresses. The proposed control is based, first, on the regulation of the dc bus voltage through the control of the power delivered by the supercapacitors, and second, on the control of the supercapacitor voltage by the operating of the fuel cell. To validate control algorithms, hardware system is realized by analogical current loops and digital voltage loops (dSPACE). Experimental results, with a ZSW PEM 500 W, 12.5 V, 40 A fuel cell and a SAFT 292 F, 30 V, 400 A supercapacitor module for a 42 V dc distributed network, confirm system operations.

## I. INTRODUCTION

Currently, fuel cells are considered as one of the most promising alternative sources of electric power in the future. Y. Kishinevsky *et al.* [1] and M.W. Ellis *et al.* [2] already reported the possibility to employ fuel cells as power source, especially Polymer Electrolyte Membrane Fuel Cell for electric vehicle applications.

In electric vehicle, dc bus voltage control has problem when electrical loads demand or recover high energy in short time (for instance, while starting or braking motor). Moreover, when fuel cell operates, its fuel flow is controlled by fuel cell processor, which receives current demand from user. The fuel flow must be adjusted to match the reactant delivery rate to the usage rate. M.E. Schenck *et al.* [3], working with a Ballard Nexa™ PEM fuel cell (1.2 kW) and P. Thounthong *et al.* [4], working with a ZSW PEM fuel cell (500 W), illustrated the main weak points of fuel cell that is fuel starvation phenomena. One demonstrated that fuel cell dynamics is limited by the hydrogen and oxygen delivery system, which contains compressor pumps, valves, and in some cases a hydrogen reformer. To present this phenomenon, Fig. 1 shows the fuel cell mechanical problems by testing two different ways for fuel flow. In Fig. 1(a), fuel cell works at constant fuel flow corresponding to the maximum available current of 50 A (40 A is the rated current). In this case, the fuel cell has always enough hydrogen and oxygen. In Fig. 1(b), the fuel flow varies depending on fuel cell current reference according to the user demand. Fig. 1 presents the dynamic response of fuel cell current loop to a step reference. One can observe on voltage curve in Fig. 1(b), which highly drops in a short time,

compared with Fig. 1 (a), the effect of mechanical delay which implies that fuel supply and delivered electrical current do not coincide. Fuel flow has difficulties to follow the current step, and this condition of operating is evidently hazardous for the fuel cell stack and will essentially lead to degrade the stack lifetime.

Therefore, to solve these problems for employing fuel cells in dynamic applications, the system must have a fast auxiliary source to supply or to absorb high transient energy. A. Rufer *et al.* [5] reported that the new high current supercapacitor technology has been developed for this purpose. Then the very fast power response of supercapacitors can be used to complement the slower power output of the fuel cell to produce the compatibility and performance characteristics needed by distributed generation system.

This paper presents a control strategy of hybrid sources having a PEM fuel cell as main source and supercapacitors as auxiliary source. The main point is to regulate the dc bus voltage, and to control fuel cell current slope in order to avoid fuel starvation. To validate control algorithms, a small-scale test bench with a 42 V dc bus, a PEM fuel cell (500 W, 12.5 V)/Supercapacitor module (291 F, 30 V) hybrid source has been realized. The experimental results illustrate the system characteristics for different loads and different operating modes (motoring or generative braking).

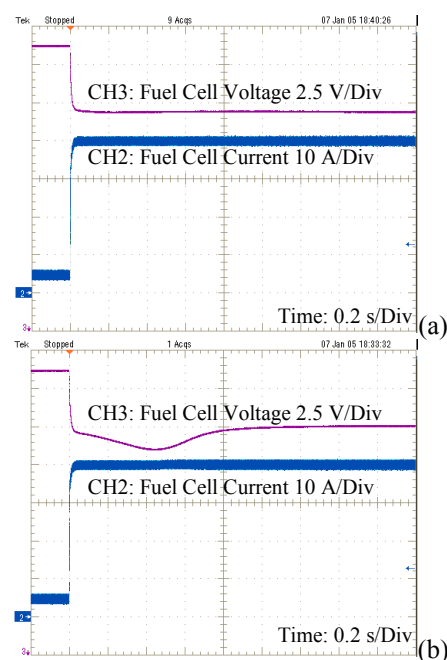

Fig. 1. Fuel cell current response to a 5-40 A step [4]. (a) Constant fuel flow (set for 50 A), (b) Variable fuel flow

## II. HYBRID POWER SOURCES

Normally, dc bus voltage  $v_{Bus}$  (for example, 500 V for Toyota Prius Hybrid Vehicle) is higher than fuel cell voltage  $v_{FC}$ . Therefore, fuel cell converter, which delivers a directional current, has to boost the fuel cell voltage to the dc bus level. Supercapacitor converter controls a bidirectional current in order to store or generate energy as presented in Fig. 2. The definitions of voltage, current and power are also depicted, where  $v_{FC}$ ,  $i_{FC}$  are the fuel cell voltage and current,  $v_{SuperC}$ ,  $i_{SuperC}$  are the supercapacitor voltage and current, and  $p_{Load}$ ,  $p_{FC}$ ,  $p_{SuperC}$  are the load, fuel cell and supercapacitor powers, to explain system operation hereafter.

For reasons of safety and dynamics, the fuel cell and supercapacitor converters are primarily operated by inner current loop controls realized by analogical circuits (Fig. 3). Therefore, current commands of fuel cell and supercapacitors depend on conditions of hybrid operation. Moreover, classical PID controller is selected for ‘‘Fuel Cell Current Controller’’, which generates duty ratio signal for the PWM generator. A hysteresis controller is selected for ‘‘SuperC Current Controller’’.

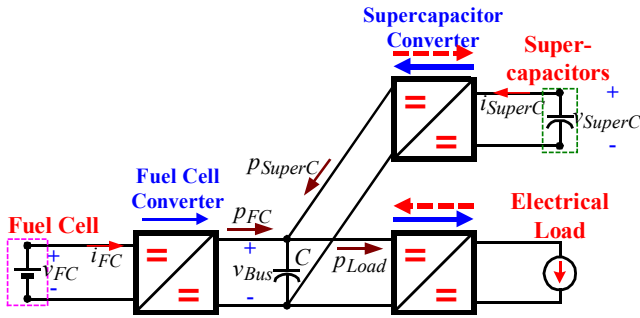

Fig. 2. Fuel cell/Supercapacitor Hybrid Power Sources.

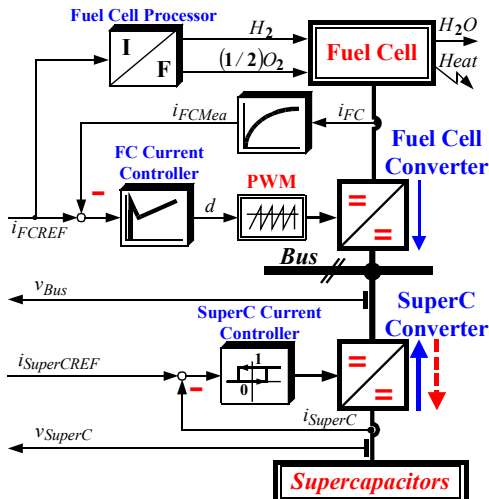

Fig. 3. Inner current control loop of hybrid sources.

The main objective of the control is to regulate dc bus voltage. Taking into account of fuel cell dynamics, fuel cell is only operating in nearly steady state conditions, and supercapacitors are functioning during transient energy

delivery or transient energy recovery. Then, hybrid control system generates two current reference signals  $i_{FCREF}$  for fuel cell (also supplies to the fuel cell processor to adjust fuel flow to the desired current) and  $i_{SuperCREF}$  for supercapacitors with the following constraints:

- 1). Fuel cell current slope must be limited to a maximum absolute value (for example, 4 A.s<sup>-1</sup>) in order to guarantee matching the reactant delivery rate and the usage rate.
- 2). Fuel cell current must be kept within an interval [ $I_{FCRated}$  (rated value),  $I_{FCMin}$  (minimum value) or zero].
- 3). Supercapacitive storage device voltage must be kept within an interval [ $V_{SuperCMin}$  (minimum value),  $V_{SuperCMax}$  (maximum value)]. Normally, the system attempts to reach the normal voltage  $V_{SuperCNormal}$ .

In previous work, A. Rufer *et al.* [5] already proposed to utilize supercapacitors-based substation for compensating voltage drop on a 700 V dc bus in which the control of supercapacitor converter is independent from the dc main source rectifier. With a fuel cell as main source, P. Thounthong *et al.* [6] have tried in hybrid sources built with a PEM fuel cell as main source and supercapacitors as auxiliary source to regulate the dc bus voltage through a power control ( $p_{Load} = p_{FC} + p_{SuperC}$ ), with a limitation of the fuel cell current slope. One of the main problems, which appear in such a control, is the presence of mode definitions (motoring or generative braking, for example) with difficulties to avoid instability when the system operates at the border of two different modes.

For this reason, the new proposed hybrid control strategy regulates the dc bus voltage through the power delivered by the fast auxiliary source, here the supercapacitors. The fuel cell, as main slow source is used to maintain the supercapacitor voltage.

### A. DC bus voltage control loop

The principle of the dc bus voltage control loop is analyzed with reference to the block diagram as shown in Fig. 4. In previous work [6], dc bus voltage was directly considered as control variable, and dc bus voltage controller demands power from hybrid sources. One of the difficulties comes from a non-linear transfer function. In order to obtain a linear system, the energy stored in the dc link capacitor  $C$  ( $E_{Bus} = 0.5CV_{Bus}^2$ ) has been considered as control variable in place of the dc bus voltage. In the proposed method by neglecting the losses in converters, the energy  $E_{Bus}$  stored in the dc bus can be written as,

$$\frac{dE_{Bus}(t)}{dt} = p_{SuperC}(t) + p_{FC}(t) - p_{Load}(t) \quad (1)$$

More precisely, the ‘‘DC Bus Energy Controller’’ generates supercapacitor power reference  $p_{SuperCREF}$ . By power conservative law and no loss assumption,  $i_{SuperCREF}$  is a consequence of  $p_{SuperCREF}$ . It is calculated by dividing  $p_{SuperCREF}$  by the measured supercapacitors voltage. Because this voltage contains harmonics due to the converter

switching and the series resistance of device (ESR), this measured signal must be filtered by low pass filter with low cut-off frequency (for example, 1 Hz). The function called “ $E_{bus}/V_{bus}$ ” is a voltage-to-energy transformation, where the energy is proportional to the total dc bus capacitance and to the square of the dc bus voltage ( $E_{Bus}=0.5CV_{Bus}^2$ ). This method can be called “indirect dc bus voltage control”.

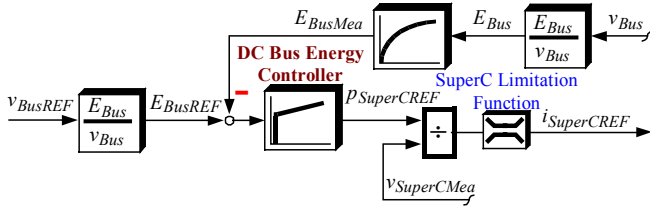

Fig. 4. DC bus voltage control loop.

Because system plant as presented in (1) composes of a pure integrator and a low-pass filter, as shown in Fig. 4, PI controller is enough for obtaining system performance, zero steady-state error and dynamics. As  $p_{load}$  and  $p_{FC}$  can be considered as perturbation terms, the open loop transfer function ( $OL$ ) can be described in order to dimension controller parameters as,

$$\left. \frac{E_{BusMea}(s)}{E_{BusREF}(s)} \right|_{OL} = \frac{\text{Energy Controller}}{K_V(T_V s + 1)} \cdot \frac{E_{Bus}/P_{SuperC}}{s} \cdot \frac{\text{Filter}}{T_I s + 1} \quad (2)$$

Simply, classical controller design called “Symmetrical Optimum” will be used to obtain desired phase margin, crossover frequency and gain margin.

### B. Supercapacitor voltage control loop and fuel cell limitation

As already mentioned before, to charge supercapacitors to  $V_{SuperCNormal}$  ( $V_{SuperCREF}$ ), supercapacitor voltage is controlled through fuel cell by “Supercapacitor Voltage Controller” demanding fuel cell current, but this signal must be limited by the first and second constrains before becoming  $i_{FCREF}$  as illustrated in Fig. 5. With this strategy, system can visibly insure that fuel cell current will gradually increase and decrease, and over rated or under minimum fuel cell current will not happen.

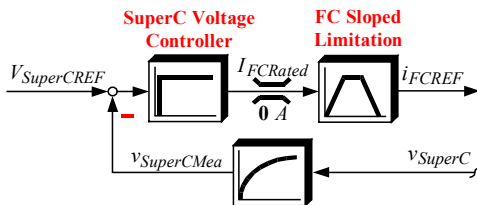

Fig. 5. Supercapacitor voltage control loop and FC limitation.

To obtain the transfer function of the supercapacitor voltage loop, one considers the fuel cell as one source and then:

$$v_{FC}(t) \cdot i_{FC}(t) = p_{Load}(t) - v_{SuperC}(t) \cdot i_{SuperC}(t) \quad (3)$$

While considering that  $v_{FC}$  and  $p_{Load}$  are disturbance of the system, (3) can be linearized under the form:

$$C_{SuperC} \frac{d\tilde{v}_{SuperC}}{dt} = \frac{V_{FC} \tilde{i}_{FC}}{V_{SuperC}} \quad (4)$$

where  $V_{FC}$  is the nominal fuel cell voltage,  $V_{SuperC}$  is the nominal supercapacitor voltage,  $\tilde{i}_{FC}$  is the fuel cell current variation,  $\tilde{v}_{SuperC}$  is the supercapacitor voltage variation, and  $C_{SuperC}$  is the supercapacitor capacitance.

Therefore, the supercapacitor voltage open control loop can be presented by the following transfer function:

$$\left. \frac{\tilde{v}_{SuperCMea}(s)}{\tilde{v}_{SuperCREF}(s)} \right|_{OL} = \frac{V_{SuperC}}{K_{VC}} \cdot \frac{\tilde{v}_{SuperC}/\tilde{i}_{FC}}{V_{FC}/V_{SuperC}} \cdot \frac{\text{filter}}{C_{SuperC}s} \cdot \frac{K_2}{T_2 s + 1} \quad (5)$$

Because of the large capacitance of the storage device, using an integral corrective action will lead to quite unstable loop. A proportional controller (P) is sufficient, as far as the gain is high enough to introduce only little static error.

### C. Supercapacitor voltage limitation

For the last constrain to keep the supercapacitor voltage within its defined limit [ $V_{SuperCMin}$ ,  $V_{SuperCMax}$ ], the supercapacitor current has to be limited. For example, during regenerative braking, fuel cell current is limited at its minimum value. As a consequence, the dc bus voltage will exceed its reference value, and therefore the voltage controller will reduce power reference to a negative value. It means that over energy will be stored in supercapacitors, and supercapacitor voltage will increase over  $V_{SuperCNormal}$ . While charging, system must limit supercapacitor voltage to  $V_{SuperCMax}$ . Hybrid system, for this reason, ensures supercapacitor voltage limitation by limiting current as proposed in Fig. 6.

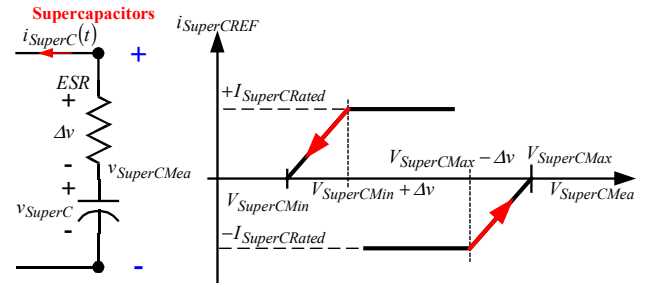

Fig. 6. Supercapacitors current limitation functions.

The minimum negative current during charging supercapacitors can be revealed by:

$$I_{SuperCMin} = -I_{SuperCRated} \times \min \left( 1, \frac{v_{SuperCMax} - v_{SuperCMea}}{\Delta v} \right) \quad (6)$$

For example, with  $V_{SuperCNormal}$  ( $V_{SuperCREF}$ ) = 13 V,  $V_{SuperCMax}$  = 15 V,  $I_{SuperCRated}$  = 200 A, and  $\Delta v$  = 0.5 V (which corresponds to an average value of the voltage drop across the ESR fixed once for the considered work), if  $v_{SuperCMea}$  = 14 V, one obtains  $I_{SuperCMin}$  = -200 A. In this case, where supercapacitors voltage is far from  $V_{SuperCMax}$ , the charging current limit  $I_{SuperCMin}$  is equal to its negative rated value  $-I_{SuperCRated}$ . In the case when the supercapacitor voltage is closed to its maximum limit, the charging current limit  $I_{SuperCMin}$  becomes greater than its negative rated value  $-I_{SuperCRated}$ . For instance, when  $v_{SuperCMea}$  is equal to 14.8 V, the charging current limit becomes -80 A.

With the same principle, one defines the upper boundary of the discharging supercapacitors current as:

$$I_{SuperCMax} = I_{SuperCRated} \times \min \left( 1, \frac{v_{SuperCMea} - v_{SuperCMin}}{\Delta v} \right) \quad (7)$$

### III. TEST BENCH STRUCTURE

In order to validate the hybrid source control, system hardware is realized with the following specifications, dc bus: 42 V, 500 W; ZSW PEM fuel cell [7]: 500 W, 40 A, 12.5 V; SAFT supercapacitor modules:  $V_{SuperCMax}$  = 30 V,  $V_{SuperCNormal}$  = 27 V,  $V_{SuperCMin}$  = 15 V, 400 A.

#### A. Fuel cell converter [4]

Fuel cell operates giving direct current at a low voltage; thereby, the boost converter, presented in Fig. 7, is selected to adapt the low dc voltage delivered by the fuel cell, which is around 12.5 V at its rated power, to the 42 V dc bus.

The fuel cell converter, designed for a 25 kHz PWM is composed of a high frequency inductor  $L_1$  (ferrite core: 72  $\mu$ H), a total dc bus capacitor  $C$  (0.702 F), a diode  $D_1$  (STPS80H100TV: 100 V, 40 A) and a main switch  $S_1$ .

Switch  $S_2$  is a shutdown device for test security to prevent the fuel cell stack from short circuits in case of accidental destruction of  $S_1$ , or faulty operation of the regulator.  $S_1$  and  $S_2$  are STE180NE10 (100 V, 180 A).

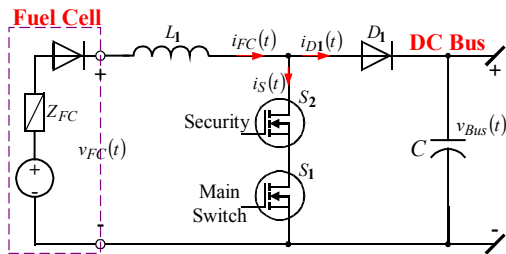

Fig. 7. Fuel cell boost converter.

#### B. Supercapacitor Converter

The supercapacitors are connected to the dc bus by means of a 2-quadrant dc/dc converter, as shown in Fig. 8.  $L_2$  (paralleling two ferrite core inductances of 350  $\mu$ H) represents the inductor used for energy transfer and filtering. The inductor size is classically defined by switching frequency and current ripple. Supercapacitor size is defined by dc bus energy requirements deduced from hybrid power profile. The supercapacitor current, which flows across the storage device, can be positive or negative, allowing energy to be transferred in both directions. Finally, the converter is driven by means of complementary pulses, generated by a hysteresis comparator, and applied on the gates of the two IGBT  $S_3$  and  $S_4$  (in one module SKM200 GB 123D: 200 A, 1200 V)

### IV. EXPERIMENTAL RESULTS AND DISCUSSIONS

The control algorithms are implemented in Matlab/Simulink environment for dSPACE interfacing card (real time card DS1104). The hybrid system communicates with the operator by means of ControlDesk software, and is linked with converters (acquisition of  $v_{SuperC}$  and  $v_{Bus}$ , generation of current reference signals  $i_{SuperCREF}$  and  $i_{FCREF}$ ) by DAC (Digital to Analog Conversion) and ADC (Analog to Digital Conversion) of dSPACE interfacing card. The hybrid system test bench, except the dc motor, is presented in Fig. 9.

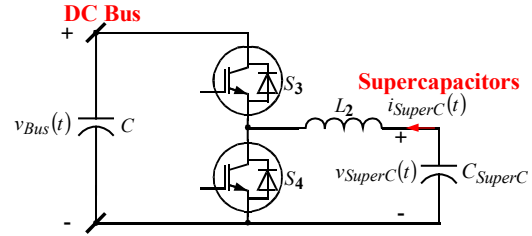

Fig. 8. 2-quadrant supercapacitor converter.

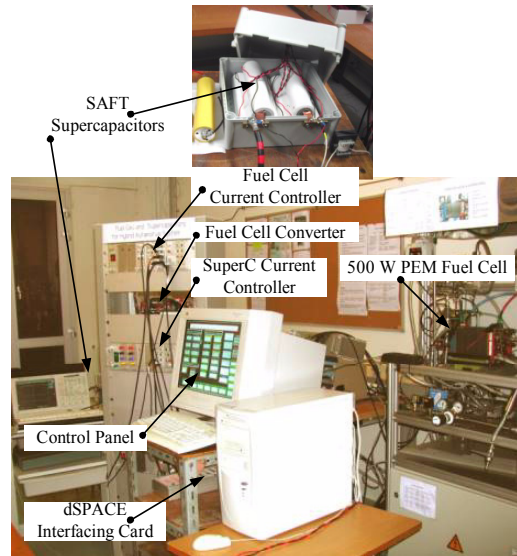

Fig. 9. Hybrid system test bench.

Technical specifications of the test bench are as follows:

- Dc bus voltage loop parameters:  $V_{BusREF} = 42$  V,  $K_I = 1V/1V$ ,  $T_I = 20$  ms,  $K_V = 14$  and  $T_V = 250$  ms
- Supercapacitor voltage loop parameters:  $\Delta v = 0.5$  V,  $I_{SuperCRated} = 200$  A,  $V_{SuperCMax} = 30$  V,  $V_{SuperCNormal}$  ( $V_{SuperCREF}$ ) = 27 V,  $V_{SuperCMin} = 15$  V,  $K_2 = 1V/1V$ ,  $T_2 = 0.16$  s (1 Hz),  $K_{VC} = 100$ , fuel cell current slope = 4 A.s<sup>-1</sup>,  $I_{FCRated} = 40$  A, and  $I_{FCMin} = 0$  A

Note that because voltage loops are implemented in dSPACE,  $K_I$  and  $K_2$  can be equal to 1V/1V. And the proportional gain  $K_{VC}$  of the supercapacitor voltage corrector is equal to 100, so that the maximum static error on supercapacitor voltage is 400 mV ( $I_{FCRated}/K_{VC}$ ).

The tests have been carried out with two different loads connected to the dc bus: a resistance, and a 2-quadrant drive with a separately excited dc motor. Motor functions with a cascade current-speed control method. A hysteresis and PI controller are selected for the motor current and speed loops, respectively with current limitation at +/-70 A.

Note that the rated power of the fuel cell is 500 W, but fuel cell converter has some losses (efficiency 88%). Then, the dc bus can absorb about 440 W from fuel cell power. This means that rated power at the dc bus is 440 W. In addition, the fuel flow is adapted to the value of the delivered current, instead of fixed fuel flow, to improve the efficiency of the system.

Fig. 10 presents hybrid characteristics during charging supercapacitors (negative current) from 25 V to 27 V. Before charging, the dc bus has a constant load which corresponds to a 7 A fuel cell current. At the beginning of charge (from 2 to 10 s), the fuel cell current reaches its rated value 40 A with a slope of 4 A.s<sup>-1</sup>. At  $t = 37$  s,  $v_{SuperC}$  is nearly equal to 27 V, and then the charging current is reduced to zero. At the end of charge ( $t = 100$  s), fuel cell current comes back to its initial value of 7 A. Clearly during this operation the dc bus voltage 42 V is barely disturbed.

Fig. 11 presents transient responses of the hybrid system to start/stop motor. From  $t = 2$  s to  $t = 10$  s, motor accelerates to 1,000 rpm. It means that motor demands peak dc bus power of nearly 2,000 W (around 4.5 times the rated power of 440 W). Clearly, control system can excellently regulate the dc bus voltage, even though the high peak load.

Firstly, when load power steps ( $t = 2$  s), the dc bus voltage inclines to reduce, and consequently the dc bus energy controller demands a positive supercapacitor power. Then  $v_{SuperC}$  is, at the same time, reduced; as a result, fuel cell current slowly increases to its rated value of 40 A. Secondly, when motor speed is constant at 1,000 rpm, its no-load current still demands overpower from the dc bus. Supercapacitors still generate power to the dc bus. The fuel cell delivers a constant power as  $v_{SuperC}$  is lower than  $V_{SuperCNormal}$  (27 V).

At  $t = 34$  s, motor is braked. It is in a regenerative mode and generates power to the dc bus. This current is limited at -70 A, and subsequently supercapacitor current changes of sign in order to absorb over energy from the dc bus, but fuel cell current is still constant because  $v_{SuperC}$  is lower than

$V_{SuperCNormal}$ . After the motor stops, the fuel cell charges supercapacitors up to  $V_{SuperCNormal}$ .

Note that because of the small motor moment of inertia and the small size mechanical load, the regenerative sequence ends rapidly.

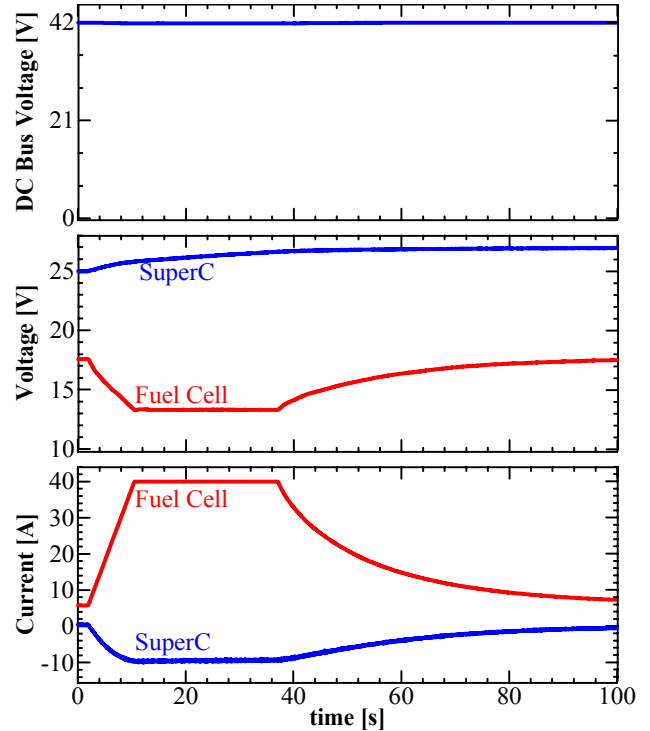

Fig. 10. Charging supercapacitors from 25 V to 27 V.

As a final test, Fig. 12 corresponds to a mechanical load step on the motor (from  $t = 10$  s to  $t = 32$  s), its speed being regulated at 500 rpm. During this operation, the dc bus has an overload of about 280%. The obtained results illustrate the excellent regulation of the dc bus voltage.

## V. CONCLUSION

The main objective of this work is to propose a new method of regulating dc bus supplied by hybrid sources for system using a PEM fuel cell, as main source, and supercapacitors as auxiliary source. The important constraint is to avoid speedy transition of fuel cell current in order to circumvent fuel starvation problem by controlling fuel cell current slope and then to reduce mechanical stresses on the system (fuel pressure, water pressure in tubes and stack). Instead of controlling the dc bus voltage through the currents or through the powers one has chosen an indirect method where the dc bus voltage controller operates on the supercapacitor power, the supercapacitor voltage being control by the fuel cell delivered current.

The experimental results on a small-scale device (42 V - 500 W PEMFC) have confirmed the excellent performances of the proposed control during motor starting or breaking and during step mechanical load. This control can be absolutely applied to other kinds of auxiliary power source, such as Li-Ion batteries, and with other kinds of main sources.

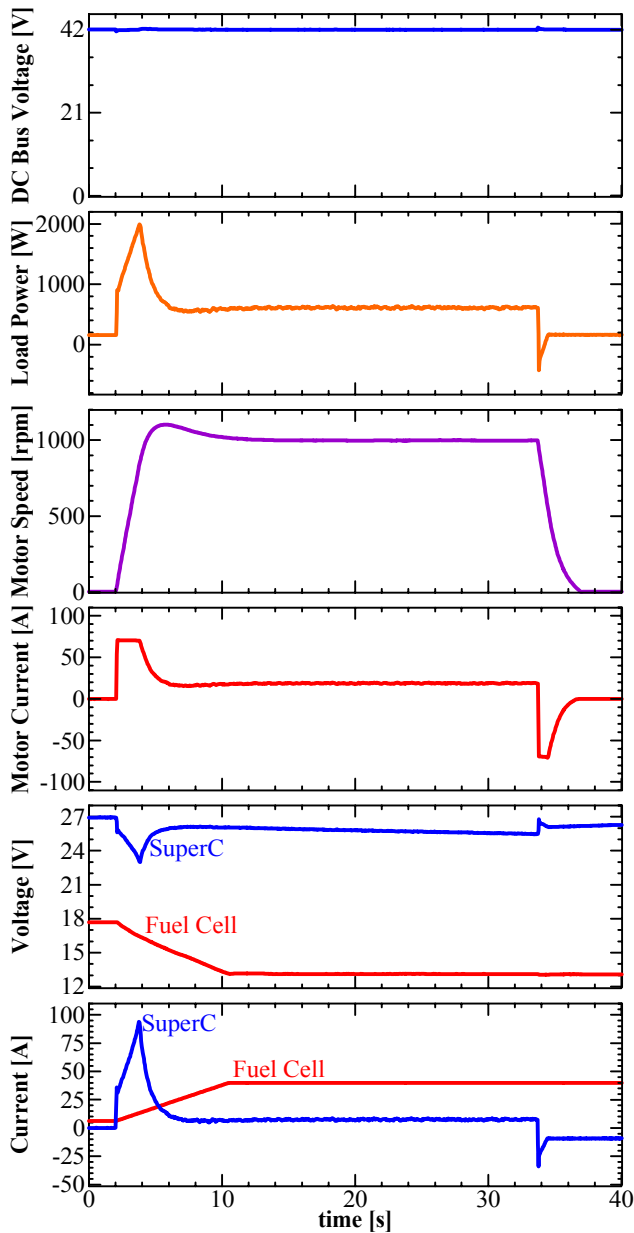

Fig. 11. System response to motor starting and breaking.

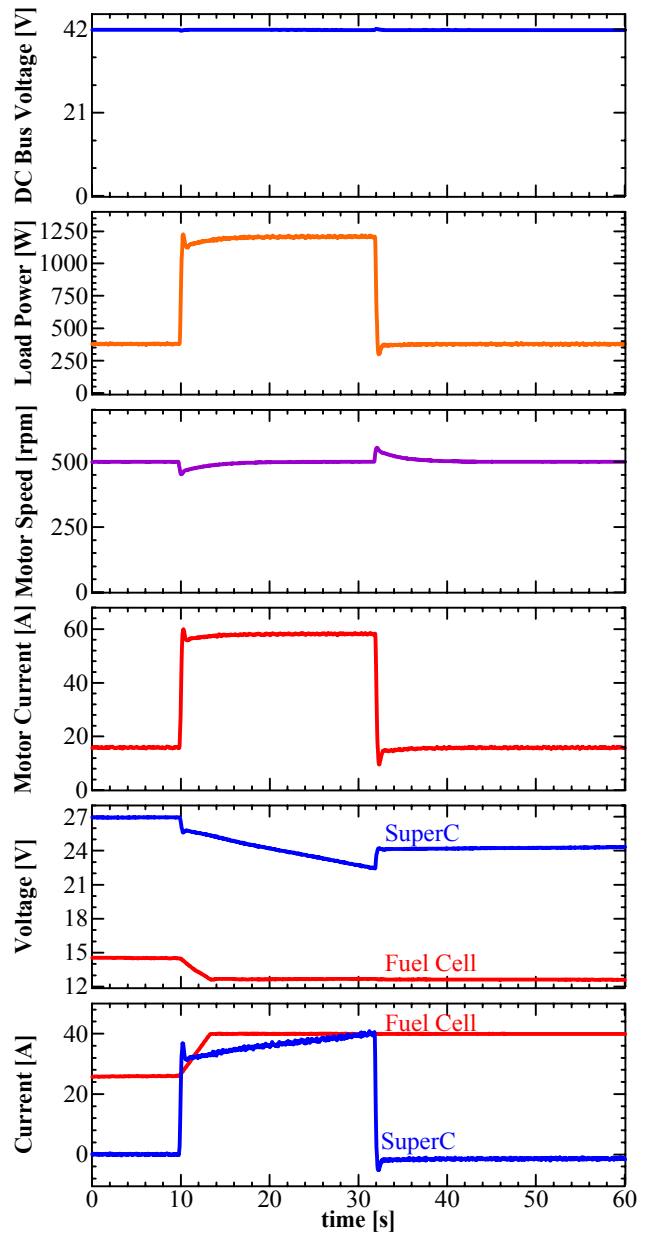

Fig. 12. System response to motor step load at 500 rpm.

#### REFERENCES

- [1] Y. Kishinevsky and S. Zelingher, "Coming clean with fuel cells," *IEEE Power & Energy Magazine*, vol. 1, issue: 6, Nov.-Dec. 2003, pp. 20-25.
- [2] M.W. Ellis, M.R. Von Spakovsky and D.J. Nelson, "Fuel Cell Systems: Efficient, Flexible Energy Conversion for the 21<sup>st</sup> Century," *Proceedings of the IEEE*, vol. 89, issue: 12, Dec. 2001, pp.1808-1818.
- [3] M.E. Schenck, J.S. Lai and K. Stanton, "Fuel Cell and Power Conditioning System Interactions," in *Proceedings of IEEE-APEC 2005 Conf.*, Texas-USA, March 6-10, 2005, pp. 114-120.
- [4] P. Thounthong, S. Raël and B. Davat, "Test of a PEM fuel cell with low voltage static converter," *J. Power Sources*, Available: <http://www.elsevier.com>.
- [5] A. Rufer, D. Hotellier and P. Barrade, "A Supercapacitor-Based Energy-Storage Substation for Voltage - Compensation in Weak Transportation Networks," *IEEE Trans. Power Delivery*, vol. 19, no. 2, April 2004, pp. 629-636.
- [6] P. Thounthong, S. Raël and B. Davat, "Utilizing Fuel Cell and Supercapacitors for Automotive Hybrid Electrical System," in *Proceedings of IEEE-APEC 2005 Conf.*, Texas-USA, March 6-10, 2005, pp. 90-96.
- [7] W. Friede, S. Raël and B. Davat, "Mathematical Model and Characterization of the Transient Behavior of a PEM Fuel Cell," *IEEE Trans. Power Electronics*, vol. 19, no. 5, Sept. 2004, pp. 1234-1241.