



HAL
open science

A metallic Fabry-Perot directive antenna

Nicolas Guérin, Stefan Enoch, Gérard Tayeb, Pierre Sabouroux, Patrick Vincent,
Hervé Legay

► **To cite this version:**

Nicolas Guérin, Stefan Enoch, Gérard Tayeb, Pierre Sabouroux, Patrick Vincent, et al.. A metallic Fabry-Perot directive antenna. IEEE Transactions on Antennas and Propagation, 2006, 54, pp.220-224. <10.1109/TAP.2005.861578>. <hal-00023192>

HAL Id: hal-00023192

<https://hal.science/hal-00023192v1>

Submitted on 24 Aug 2022

HAL is a multi-disciplinary open access archive for the deposit and dissemination of scientific research documents, whether they are published or not. The documents may come from teaching and research institutions in France or abroad, or from public or private research centers.

L'archive ouverte pluridisciplinaire HAL, est destinée au dépôt et à la diffusion de documents scientifiques de niveau recherche, publiés ou non, émanant des établissements d'enseignement et de recherche français ou étrangers, des laboratoires publics ou privés.



Distributed under a Creative Commons CC BY-NC 4.0 - Attribution - Non-commercial use - International License

A Metallic Fabry–Perot Directive Antenna

Nicolas Guérin, Stefan Enoch, Gérard Tayeb, Pierre Sabouroux, Patrick Vincent, and Hervé Legay

Abstract—We report the design of a directive antenna using the electromagnetic resonances of a Fabry–Perot cavity. The Fabry–Perot cavity is made of a ground plane and a single metallic grid. The resonance is excited by a patch antenna placed in the cavity at the vicinity of the ground plane. The two remarkable features of Fabry–Perot cavity antennas are, first, that they are very thin and second that only one excitation point is needed. A directivity of about 600 is measured at $f = 14.80$ GHz which is to our knowledge one of the highest directivities reported for an antenna using Fabry–Perot resonances.

Index Terms—Directive antennas, Fabry–Perot resonators, leaky wave antennas.

I. INTRODUCTION

IN the past few years new solutions have been proposed to design directive sources that combine both compactness and a single feeding point. The first solution proposed is to use resonant cavities in dielectric photonic crystals. The simplest proposed design is based on one-dimensional (1-D) photonic crystals [1], [2].

B. Temelkuran *et al.* [3], [4] have proposed to use three-dimensional (3-D) dielectric photonic crystals rather than 1-D leading to a structure slightly more intricate but still easily realizable in the microwave domain. This group has shown that the 3-D structures lead to better performances than 1-D and justify the higher complexity.

Another solution proposed by our group was to use a source embedded in a metamaterial that simulates a low optical index homogeneous medium [5]. The metamaterial was made of a stack of copper grids and slices of foam (mainly used as a mechanical spacer). A simple way to understand the physical principle is to consider grazing rays radiated by the source on the interface metamaterial-air. Because of the low value of the optical index, they will be refracted in a direction close to the normal of the interface as required by the Snell–Descartes laws. Consequently, the radiated energy will be concentrated in a lobe around the normal. Performances similar to the 3-D photonic crystal based antenna have been obtained.

The Fabry–Perot cavity antenna are obviously cavity antennas that have been studied for a long time in the microwave community. Several applications have been proposed for similar structures such as antennas with the required phase-front and amplitude linearity for helicopter stabilization [6] or tracking

N. Guérin is with the Laboratory for Electromagnetic Fields and Microwave Electronics, Swiss Federal Institute of Technology, 8092 Zürich, Switzerland (e-mail: nguerin@ifh.ee.ethz.ch).

S. Enoch, G. Tayeb, P. Sabouroux, and P. Vincent are with the Fresnel Institute, CNRS 6133, Université d’Aix-Marseille III, Faculté des Sciences et Techniques, 13397 Marseille cedex 20, France.

H. Legay is with Alcatel Space, 31037 Toulouse cedex, France.

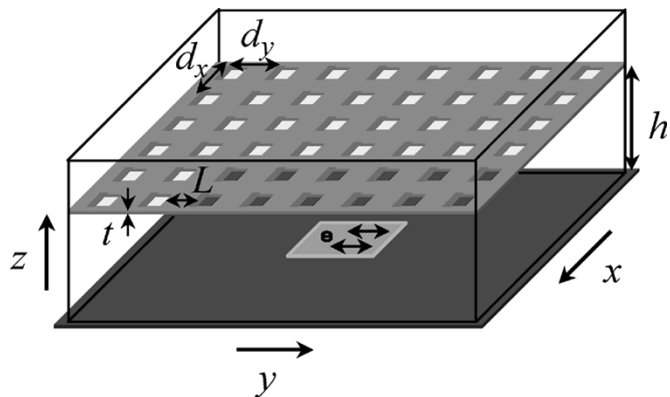

Fig. 1. Schematic representation of the antenna based on a Fabry–Perot cavity, the black lines delimit the volume occupied by the foam. For the prototype $L = 3.06$ mm, $t = 0.14$ mm, $d_x = d_y = 5.8$ mm, and $h = 9$ mm.

systems for missiles [7]. An exhaustive source about the theory, design and practical applications of the cavity-type antennas can be found in [8]. More recently, it has also been proposed to design cavity antennas with nonuniform mirrors to obtain very low sidelobes [9].

In this paper, we report the design of a source that uses a Fabry–Perot resonance with a cavity made of a ground plane and we use a single metallic grid as reflector. The structure is designed for the *Ku*-band (12–18 GHz).

First, we describe the actual prototype of the antenna. Then, we present the 3-D modeling which allowed us to optimize the parameters of the structure in order to obtain a high directivity at the suitable frequency. Finally, experimental results are shown, and a good agreement with the modeling is obtained. The realized antenna has a directivity of about 600 and presents a very low cross-polarization level.

II. DESCRIPTION OF THE STRUCTURE

The antenna is a parallelepipedal flat structure with a square base of 23 cm side (11λ side at 14.3 GHz) and a thickness of about 1 cm. Note that the lateral size of the actual antenna has not been optimized since our goal was not to obtain large surface efficiency, thus it can probably be reduced without important change in the obtained directivity. The cavity is bounded by a copper ground plane and a copper grid (Fig. 1): the ground plane acts as a perfect mirror, and the grid acts as a partially reflecting mirror.

The feeding device is a square patch with 8.6 mm width and placed 1.84 mm above the ground plane. It is fed by a coaxial cable coming from the ground plane. The feeding point of the patch is off-center along the y -axis in order to have the currents predominantly along this axis (arrows in Fig. 1) and the emitted electric field mainly polarized linearly in the yOz plane (E plane).

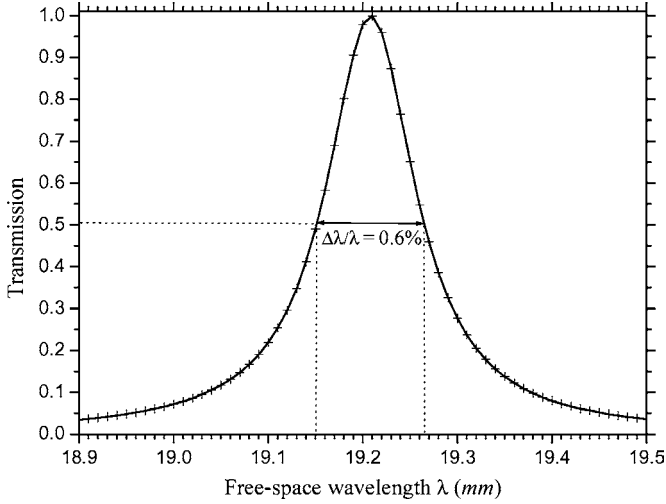

Fig. 2. Transmission of the cavity with respect to the wavelength, for normal incidence. The electric field is linearly polarized along the x -axis.

The grid is a bi-periodic array with 5.8 mm periods of crossed copper strips, which are 0.14 mm thick (along the z -axis) and 3.06 mm large. This array is made of 40×40 elementary cells. The cavity is filled with a foam whose permittivity is close to 1 ($\epsilon = 1.07$ at 14 GHz) that ensures the spacing between the grid and the ground plane. The thickness of the foam is $h = 9$ mm.

III. MODELING OF THE STRUCTURE

A 3-D simulation code was developed to calculate the electrical field emitted by such a metallic structure. This code is based on the method of moments using a thin wire approximation [10]. The ground plane is taken into account using image theory. Thus we study a symmetric cavity made of two grids with the thickness $e = 2h$. The mirrors are modeled as a bi-periodic array of crossed wires, the development of a fast bi-periodic Green's function [11] reduces the model discretization to only a single cell of the grating. Note that the actual grids are made of thin copper plates, so that the cross section of the strips is rectangular. In order to model the strips with a sufficient accuracy with our code, we replace each strip by a mesh made of 15 parallel perfectly conducting wires. The diameter of the wires is equal to the thickness of the copper strips (equal to 0.14 mm due to available copper sheets thickness).

The parameters of the meshes are optimized with the 3-D code to obtain a high directivity at a frequency around 14 GHz. The optimization is done in two steps: first, the optimum propagation properties of the cavity are determined by considering only the transmission of two grids without the patch. The reason is that the beam width of the antenna is directly linked with the angular selectivity of the structure illuminated by a plane wave under the incidence θ [12]. It means that the choice of the parameters of the antenna (first section) can be achieved thanks to the modeling of the structure when the cavity is excited by a plane wave. This simplifies the computations. Secondly, the antenna is simulated and the directivity and cross polarization are estimated.

Fig. 2 shows the transmission as a function of the wavelength under normal incidence. The wavelength giving the maximum

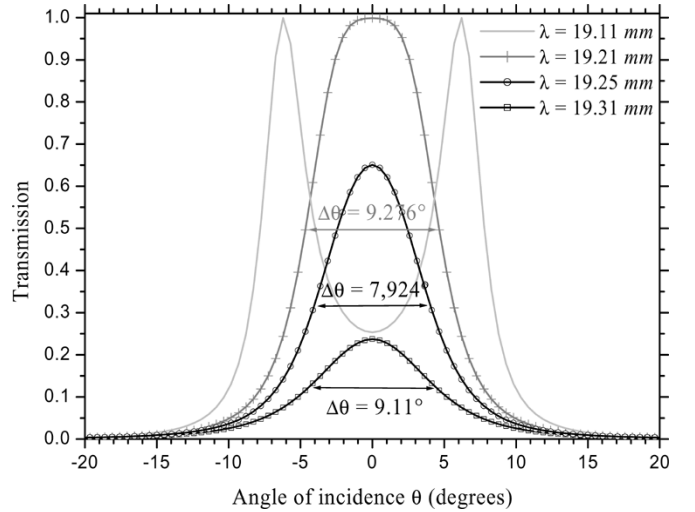

Fig. 3. Transmission of the cavity with respect to the incidence angle for different wavelengths. The incident electric field is perpendicular to the plane of incidence.

of transmission is $\lambda_r = 19.21$ mm, and the transmission-bandwidth is equal to 0.6%. However, only wavelengths slightly larger than λ_r must be considered. This is shown in Fig. 3: for $\lambda < \lambda_r$, the transmission maximum is not along the direction $\theta = 0$ (normal of the structure), but along the direction defined by $\theta = \arccos(\lambda/\lambda_r)$. As a consequence the expected emission diagram for the antenna is not a lobe centred around the normal but a conical radiation pattern. Hence, for $\lambda < \lambda_r$ the antenna will not have the required properties in terms of directivity. For $\lambda \geq \lambda_r$, the maximum of transmission corresponds to $\theta = 0$, thus, it is expected that the antenna will emit a main lobe focussed around the normal of the structure. Moreover, the best angular selectivity is obtained for $\lambda_b = 19.25$ mm and not for λ_r , consequently the maximum directivity of the antenna will be expected for λ_b and not for λ_r .

In order to model the antenna excited by the patch, we assume that the incident field on the bi-periodic grid is the field radiated by the patch in vacuum. This field is expressed as a superposition of plane waves whose amplitudes are obtained using a bidimensional fast Fourier transform (FFT) [13]. The drawback of this procedure is that the number of grating problems to solve is equal to the number of propagating plane waves obtained from the FFT. Nevertheless, we are able to run our code on a personal computer. Note that due to the image theory, the source is composed by the actual one (patch) and its image.

Fig. 4 shows the far-field radiation patterns for the patch without the grid (but with the ground plane). Obviously, we get a broad pattern as usual for this kind of antennas. The asymmetry in the E-plane (i.e., plane $x = 0$) is due to the position of the feeding point on the patch. When the patch is covered with the bi-periodic grid, we observe (Fig. 5) that the emission is concentrated in a narrow lobe. The emitted field is quasilinearly polarized and the maximum level of cross-polarization is about -30 dB. Fig. 6 shows the behavior of the antenna when the wavelength is varying. As previously, we observe a typical behavior for such resonators: putting $\lambda_r = 19.21$ mm, when $\lambda < \lambda_r$, the maximum of emission is not along the normal to the antenna, and when $\lambda > \lambda_r$, we can get a narrower lobe than

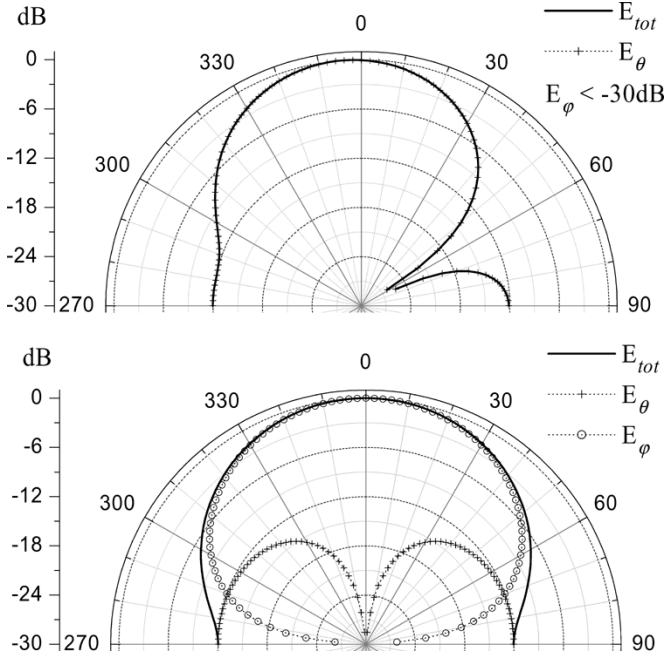

Fig. 4. Radiation patterns (normalized dB scale) of the patch without the grid in the E plane and the H plane. In the E plane, the E_φ component is not visible since it is much less than -30 dB.

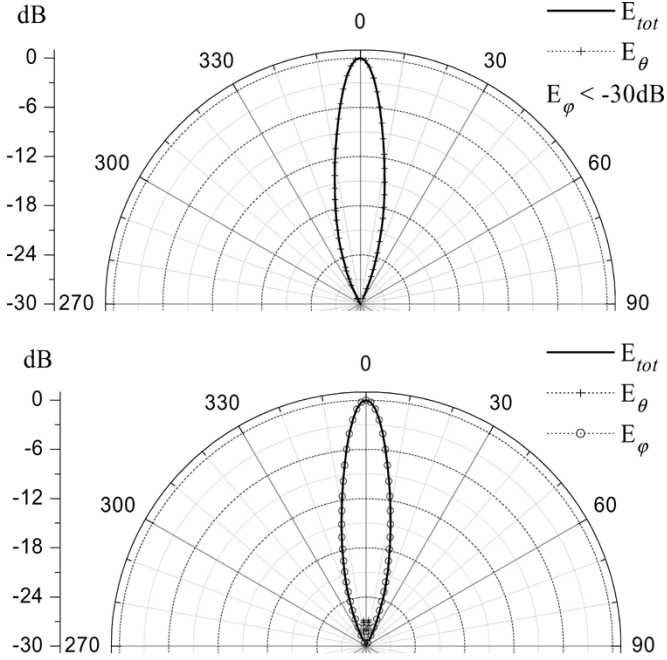

Fig. 5. Radiation patterns (normalized dB scale) of the antenna in the E plane and the H plane. In the E plane, the E_φ component is not visible since it is much less than -30 dB.

for λ_r . The narrowest lobe is obtained for $\lambda_b = 19.25$ mm. The highest theoretical value of the antenna directivity is 715 at $f = 15.6$ GHz (see Fig. 7).

IV. EXPERIMENTAL STUDY

The prototype of the antenna has already been depicted in Section II. The measurements have been made in an anechoic chamber whose dimensions are 14.5 m long, 6.20 m wide

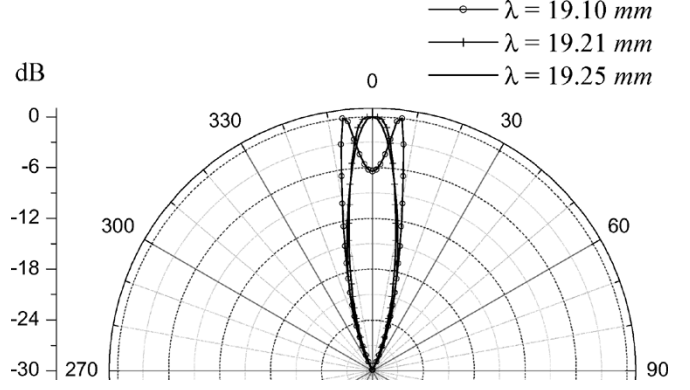

Fig. 6. Radiation patterns (normalized dB scale) of the antenna for different values of the wavelength.

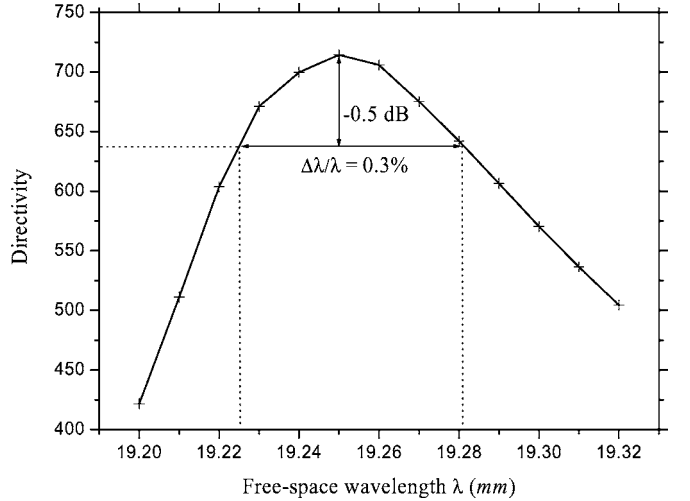

Fig. 7. Directivity deduced from the computed radiation patterns with respect to the wavelength: the bandwidth is about 0.3%.

and 6.20 m high. The available frequency range can go from 300 MHz to 26.5 GHz. A large variety of experimental configurations can be studied, thanks to four mechanical positioners. The radiation pattern has been measured at a distance of about 2 m and it has been checked that the radiation pattern is identical at a distance of 10.5 m.

The radiation patterns for three different wavelengths are shown in Fig. 8 for both the E-plane and the H-plane. A qualitative agreement is obtained in the behavior of the antenna. The resonance wavelength λ_r is slightly below the wavelength corresponding to the maximal directivity $\lambda_b = 20.26$ mm ($f = 14.80$ GHz). For lower values of the wavelength, several lobes are observed. Moreover we have also a good quantitative agreement: the experimental value of the wavelength λ_b is measured to be 20.26 mm while the theoretical value is 19.25 mm (5% of difference). These slight discrepancies are attributed to two factors. First, we do not know exactly the permittivity of the foam. Second, the foam thickness h is not perfectly constant and equal to 9 mm. The obtained discrepancies are consistent with the tolerance given by the manufacturer of the foam (thickness tolerance equal to 0.5 mm).

The E-plane radiation pattern in Fig. 8 exhibits an asymmetry that is not present in the theoretical model. We attribute this to the excitation point of the feeding patch and to the tolerance in

V. CONCLUSION

We have presented a numerical and experimental study of a Fabry–Perot cavity antenna and a good agreement has been obtained. High directivities have been obtained both theoretically and experimentally (resp. 715 at $f = 15.6$ GHz and about 600 at $f = 14.8$ GHz). Beside the small thickness and the single feeding device, the weight of our prototype of the antenna is low, thus it could be interesting for spatial applications.

The small value of bandwidth should be increased by considering aperiodic grids. This could also open new opportunities for high surface efficiency antennas. Finally, the use of a high impedance surface as ground plane should be considered. This might improve the performances, specially it might reduce the thickness of the antenna.

REFERENCES

- [1] M. Thèvenot, C. Cheype, A. Reinex, and B. Jecko, "Directive photonic-bandgap antennas," *IEEE Trans. Microw. Theory Tech.*, vol. 47, no. 11, pp. 2115–2121, Nov. 1999.
- [2] C. Cheype, C. Serier, M. Thèvenot, T. Monédière, A. Reinex, and B. Jecko, "An electromagnetic bandgap resonator antenna," *IEEE Trans. Antennas Propag.*, vol. 50, no. 9, pp. 1285–1290, Sep. 2002.
- [3] B. Temelkuran, M. Bayindir, E. Ozbay, R. Biswas, M. Sigalas, G. Tuttle, and K. Ho, "Photonic crystal-based resonant antenna with a very high directivity," *J. Appl. Phys.*, vol. 87, no. 1, pp. 603–605, Jan. 2000.
- [4] E. Ozbay, B. Temelkuran, and M. Bayindir, "Microwave applications of photonic crystals," *Progress Electromagn. Res. PIER 41*, pp. 185–209, 2003.
- [5] S. Enoch, G. Tayeb, P. Sabouroux, N. Guérin, and P. Vincent, "A metamaterial for directive emission," *Phys. Rev. Lett.*, vol. 89, no. 21, pp. 213 902-1–213 902-4, Nov. 2002.
- [6] P. J. Klass, "Helicopter stabilized by microwave beam," *Aviation Week and Space Technol.*, vol. 79, pp. 85–89, 1968.
- [7] E. C. Belee, R. C. Breithaupt, D. L. Godwin, and S. H. Walker, "Image element antenna array for a monopulse tracking system for a missile," U.S. Patent 3 990 078, Nov. 2, 1976.
- [8] A. Kumar and H. D. Hristov, *Microwave Cavity Antennas*. New York: Artech House, 1989.
- [9] R. Sauleau, P. Coquet, T. Matsui, and J.-P. Daniel, "A new concept of focusing antennas using plane-parallel Fabry–Perot cavities with nonuniform mirrors," *IEEE Trans. Antennas Propag.*, vol. 51, no. 11, pp. 3171–3175, Nov. 2003.
- [10] G. Guida, D. Maystre, and G. Tayeb, "Electromagnetic modeling of three-dimensional metallic photonic crystals," *J. Electromagn. Waves Applicat.*, vol. 12, no. 9, pp. 1153–1179, 1998.
- [11] N. Guérin, S. Enoch, and G. Tayeb, "Combined method for the computation of the doubly periodic Green's function," *J. Electromagn. Waves Applicat.*, vol. 15, no. 2, pp. 205–221, Feb. 2001.
- [12] A. Feresidis and J. Vardaxoglou, "High gain planar antenna using optimized partially reflective surfaces," *Proc. Inst. Elect. Eng. Microwaves, Antennas and Propagation*, vol. 148, no. 6, pp. 345–350, Dec. 2001.
- [13] E. Brigham, *The Fast Fourier Transform*. Englewood Cliffs, NJ: Prentice-Hall, 1974.

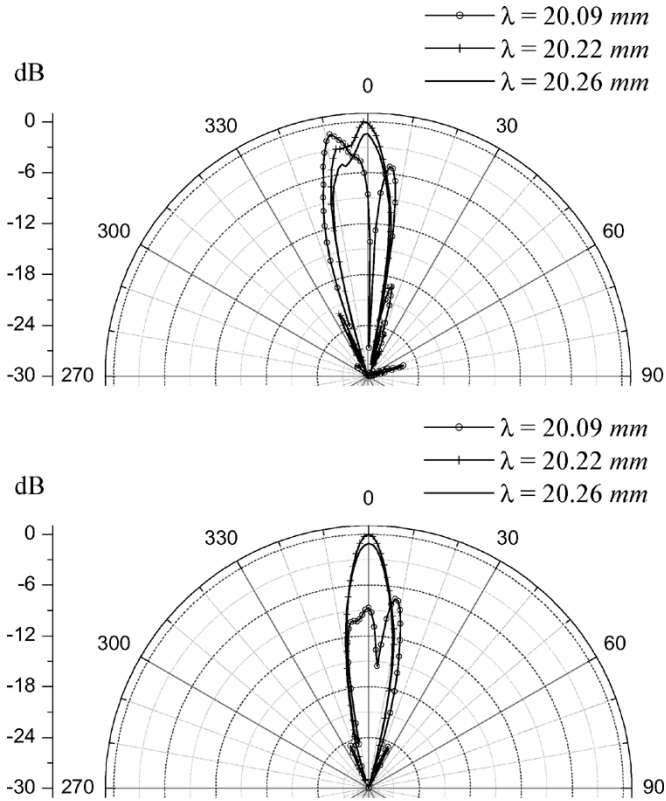

Fig. 8. Experimental radiation patterns (normalized decibels scale) of the antenna in the E plane (top) and the H plane (bottom). The radiation patterns have been normalized with respect to the maximum of emission for the three wavelengths.



Fig. 9. Experimental directivity of the antenna.

the realization of the antenna. This asymmetry induces a lower value for the directivity than expected, but it is still about 600. The very low level of the side lobes should also be noted. Fig. 9 shows the measured directivity as a function of the wavelength. As predicted by our theory we can find a passband for the directivity of about 0.3%. Note that, although the design of the structure has not been optimized to obtain an impedance matching, we have measured a value of about -5 dB for the S_{11} coefficient for the frequency corresponding to the maximum of directivity.