



HAL
open science

Realization of a 5 and 10 MHz High Performance Isolation Distribution Amplifier for short term frequency stability measurements of frequency sources

Patrice Salzenstein, Franck Lardet-Vieudrin

► **To cite this version:**

Patrice Salzenstein, Franck Lardet-Vieudrin. Realization of a 5 and 10 MHz High Performance Isolation Distribution Amplifier for short term frequency stability measurements of frequency sources. 19th European Frequency and Time Forum, Besançon, France. March 2005, 2005, France. pp.405-407. hal-00022855

HAL Id: hal-00022855

<https://hal.science/hal-00022855>

Submitted on 14 Apr 2006

HAL is a multi-disciplinary open access archive for the deposit and dissemination of scientific research documents, whether they are published or not. The documents may come from teaching and research institutions in France or abroad, or from public or private research centers.

L'archive ouverte pluridisciplinaire **HAL**, est destinée au dépôt et à la diffusion de documents scientifiques de niveau recherche, publiés ou non, émanant des établissements d'enseignement et de recherche français ou étrangers, des laboratoires publics ou privés.

REALIZATION OF A 5 AND 10 MHZ HIGH PERFORMANCE ISOLATION DISTRIBUTION AMPLIFIER FOR SHORT TERM FREQUENCY STABILITY MEASUREMENTS OF FREQUENCY SOURCES

P. Salzenstein and F. Lardet-Vieudrin

FEMTO-ST Institute, Department LPMO, CNRS UMR 6174

LNE associate laboratory No 2.13

32 avenue de l'Observatoire, 25044 Besançon Cedex

Phone: +33 (0)3 81 85 39 99, Fax: +33 (0)3 81 85 39 98, e-mail : patrice.salzenstein@lpmo.edu

ABSTRACT

Our Laboratoire National d'Essai (LNE) associate laboratory is accredited to deliver calibration certificates in the short term domain. For spectral density of phase noise and short term frequency stability measurements, it is necessary to have the best reference source signals. However, the noise of the distribution amplifier has to be the weakest possible in order to keep the lowest noise floor. In order to deliver references signals, we achieve a high performances distribution amplifier. In terms of Allan variance, performance of the realized four channels distribution amplifier is respectively better than $\sigma_y(\tau = 1s) = 1,4 \cdot 10^{-14}$ and $7,3 \cdot 10^{-15}$ at 5 and 10 MHz. The intrinsic spectral density of phase noise is then better than $S\phi(1\text{Hz}) = -141,4 \text{ dB} \cdot \text{rad}^2/\text{Hz}$ at 5 MHz and $-141 \text{ dB} \cdot \text{rad}^2/\text{Hz}$ at 10 MHz with a $1/f$ slope.

KEYWORDS

Distribution amplifier, short term frequency stability, spectral density of phase noise

INTRODUCTION

Any laboratory needs the Allan variance parameter in order to characterize its standards in terms of short term frequency stability for an integration time (τ) typically in the 0.1 s - 100 s range. Of course it is necessary to have the best references.

However, if we use 5 MHz and 10 MHz distribution amplifiers with the lowest phase noise floor, the performances of the reference standard are not limited by the distribution amplifier. For an integration time of 1 s, the frequency stability of the distribution amplifier has to be better than the best available quartz references which present typically $6 \cdot 10^{-14}$ frequency stability.

1. DISTRIBUTION AMPLIFIER DESIGN AND REALIZATION

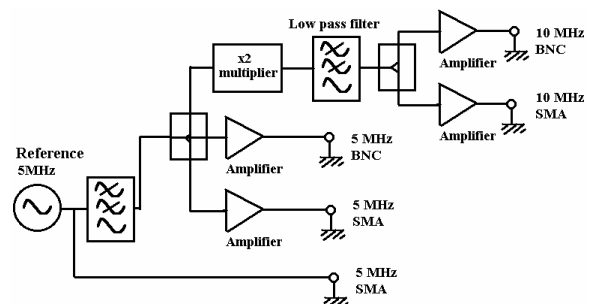

Fig. 1. Electric schematic of the 5 and 10 MHz distribution amplifier

Figure 1 describes the electric schematic of the distribution amplifier. The distribution amplifier performances have been previously evaluated through a *SPICE* simulation. At 5 MHz, the isolation is expected to be equal to -107.9 dBc whereas phase of the signal is much closed to -180° . We also observe a good output power signal flatness for both 5 and 10 MHz frequencies. Our purpose consists in optimizing the performances of this device in order to integrate it with the best available commercial oscillators. Moreover this distribution amplifier is able to deliver two 5 MHz outputs and two 10 MHz outputs.

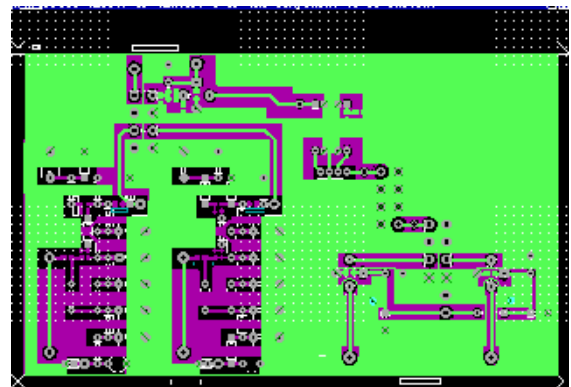

Fig. 2. Lay out of the distribution amplifier

In order to deliver the 10 MHz signals, on one arm, we placed an amplifier and a x2 multiplier based on a hybrid junction. We connected the two 10 MHz outputs after the amplifiers and a power splitter. Between the different output channels, the distribution amplifier to be realized has to reject the signals as good as possible. In the table I, we present the rejection of the harmonic signals. A ‘4643A’ *Hewlett-Packard* synthesizer was connected to the input of the distribution amplifier delivering 7 dBm.

TABLE I
LEVEL OF THE HARMONICS FOR A 7 dBm 5 MHz INPUT SIGNAL

Frequency (MHz)	OUTPUT (dBc)
10	-41
20	-56
30	-63
40	-71
50	-91

For an improvement of the performances, we added a filter before the input of the distribution amplifier. We obtained the following results: -41 dBc, -76 dBc, -91 dBc respectively for the 10 MHz, 20 MHz, 30 MHz harmonics at the 5 MHz output.

2. DISTRIBUTION AMPLIFIER PERFORMANCES

Realization of the distribution amplifier allows us to provide several outputs distributed at 5 and 10 MHz. As the reference standard we can possibly use an ultra-stable 5 MHz Quartz Voltage Controlled Crystal Oscillator (VCXO). The distribution amplifier contains x2 multipliers developed in our laboratory. The realized distribution amplifier is shown on the figure 3.

Using a ‘3048’ *Hewlett-Packard* phase noise measurement bench, the spectral density of phase noise characterizing the distribution amplifier has been measured. To achieve such measurement we rejected an *Oscilloquartz OSA 8607* 5 MHz Swiss oscillator known as an ultra-stable source. Typically such quartz oscillators present an Allan variance $\sigma_y(\tau = 1s) = 8.10^{-14}$. As it was mentioned above, the distribution amplifier has to present a better frequency stability performance in order to avoid limitations in the performances for such reference. Applying this experiment, the distributed signal on the 5 MHz and 10 MHz outputs are able to keep the performances of the reference in terms of frequency

stability. According the equivalence formula of the frequency Flicker noise, we deduce from the phase noise obtained in the spectral domain, the corresponding Allan variance in the time domain. Then these results have been compared with those obtained by measuring the Allan variance using an time interval analyzer TSC 5110A *Timing Solutions*.

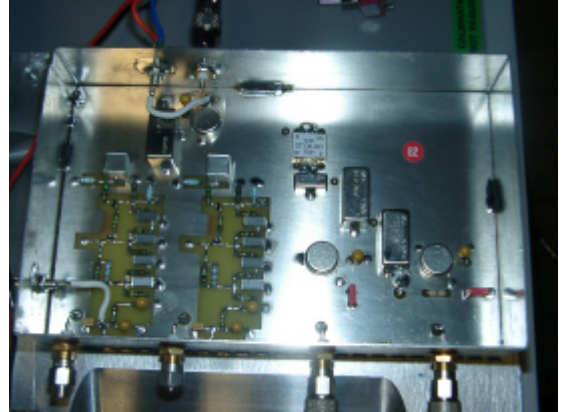

Fig. 3. 5 and 10 MHz distribution amplifier

First of all we measured the spectral density of phase noise of the VCXO on the phase noise measurement bench. We obtained -127 dB.rad²/Hz at 1 Hz from the carrier at 5 MHz. Then we measured the Allan variance on the time interval analyzer as $8.8.10^{-14}$.

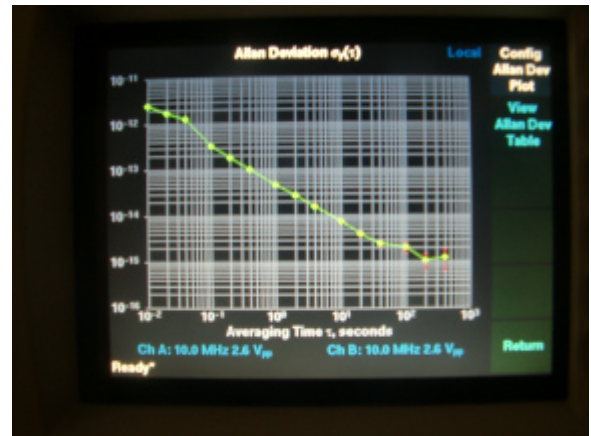

Fig. 4. Distribution amplifier measured Allan variance at 10 MHz on the time interval analyzer

Our results show a rejection of the oscillator noise, through the distribution amplifier. Actually, connecting two outputs of the distribution amplifier on the time interval analyzer, measured Allan variances are respectively equal to $4.8.10^{-14}$ and $2.3.10^{-14}$ at 5 MHz and 10 MHz. Moreover, the obtained Allan variances $\sigma_y(\tau)$ exactly corresponds to the instrument floor given by the manufacturer, *i.e.*, 5.10^{-14} and $2.5.10^{-14}$ respectively at 5 MHz and 10

MHz. In our case, the measure of the Allan variance was immediately computed by the system which counts frequencies. However it is limited by the performances of the bench. Phase noise measurement principle is presented on figure 5.

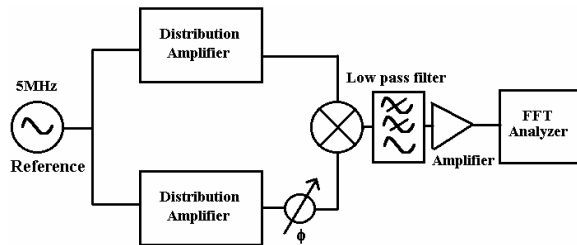

Fig. 5. Phase noise measurement principle

Then we deduced the performances of the distribution amplifier by analyzing the results of the phase noise measurement as presented on the figures 6 and 7. $S_{\phi}(1\text{Hz}) = -141.4 \text{ dB}\cdot\text{rad}^2/\text{Hz}$ at 5 MHz and $-141 \text{ dB}\cdot\text{rad}^2/\text{Hz}$ at 10 MHz with a $1/f$ slope. It was obtained by measuring the phase noise of two similar outputs of the distribution amplifier.

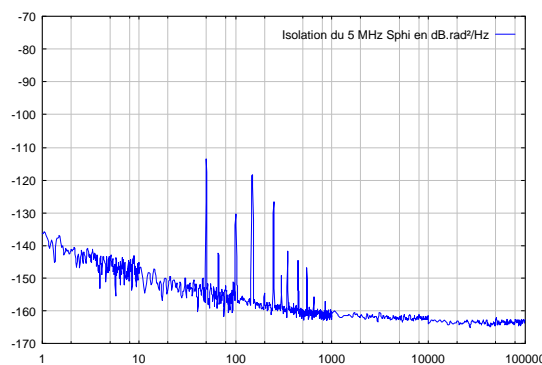

Fig. 6. Phase noise of 5 MHz distribution amplifier measured on the ‘3048’ bench

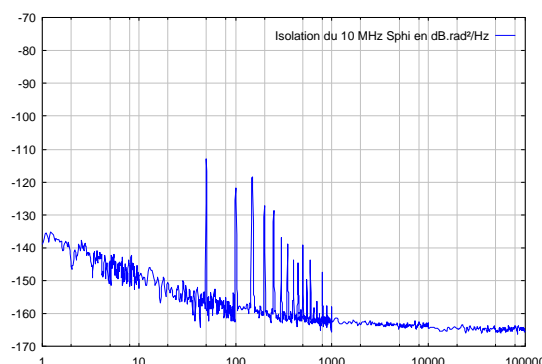

Fig. 7. Phase noise of the 10 MHz distribution amplifier measured on the ‘3048’ bench

We deduced the value considering that the two output have identical contribution to the noise. For a $1/f$

slope in the spectral domain, we use the following relation [1] that allows to deduce $\sigma_y(\tau)$ versus the spectral density of phase noise :

$$\sigma_y(\tau)^2 = h_1/(4\pi^2 \cdot \tau^2) + [9/2 + 3 \text{Ln}(2\pi F_h \tau) - \text{Ln}2]$$

where h_1 is the coefficient of the slope at 1Hz, τ the integration time, F_h cutoff frequency of the noise.

This equation allows us to estimate the frequency stability in terms of Allan variance, $\sigma_y(\tau) = 1,39 \cdot 10^{-14}$ at 1s for the 5 MHz signal, and $\sigma_y(\tau) = 7,29 \cdot 10^{-15}$ at 1s for 10 MHz.

SUMMARY

The distribution amplifier realized in our laboratory presents efficient performances. At 5 MHz and 10 MHz, we obtain better than $\sigma_y(\tau) = 1,4 \cdot 10^{-14}$ and $7,3 \cdot 10^{-15}$ respectively, that corresponds to phase noise floor better than $S_{\phi}(1\text{Hz}) = -141,4 \text{ dB}\cdot\text{rad}^2/\text{Hz}$ at 5 MHz and $-141 \text{ dB}\cdot\text{rad}^2/\text{Hz}$ at 10 MHz with a $1/f$ slope. These results are closed to the state-of-the-art NIST results [2].

REFERENCES

- [1] C. Audoin, M. Y. Bernard, R. Besson, J. J. Gagnepain, J. Gros Lambert M. Grandveaud, J.C. Naud, M. Olivier et J. Rutman, La mesure de la fréquence des oscillateurs, CHRONOS, Collection technique et scientifique des télécommunications, MASSON, 1991, pp. 86-89
- [2] C. W. Nelson, F. L. Walls, M. Sicarrdi, A. DeMarchi, A new 5 and 10 MHz high isolation distribution amplifier, IEEE Frequency Control Symposium, Boston, USA, 1-3 june 1994, pp. 567-571