



HAL
open science

EMI estimation for DC/AC hard switching converter using Wiener filter

Piotr Musznicki, Jean-Luc Schanen, Pierre Granjon, Piotr Chrzan

► To cite this version:

Piotr Musznicki, Jean-Luc Schanen, Pierre Granjon, Piotr Chrzan. EMI estimation for DC/AC hard switching converter using Wiener filter. 12th IEEE International Conference on Power Electronics and Motion Control (PEMC 2006), 2006, Portoroz, Slovenia. hal-00021547v1

HAL Id: hal-00021547

<https://hal.science/hal-00021547v1>

Submitted on 28 Mar 2006 (v1), last revised 24 May 2006 (v2)

HAL is a multi-disciplinary open access archive for the deposit and dissemination of scientific research documents, whether they are published or not. The documents may come from teaching and research institutions in France or abroad, or from public or private research centers.

L'archive ouverte pluridisciplinaire **HAL**, est destinée au dépôt et à la diffusion de documents scientifiques de niveau recherche, publiés ou non, émanant des établissements d'enseignement et de recherche français ou étrangers, des laboratoires publics ou privés.

EMI estimation for DC/AC hard switching converter using Wiener filter

Piotr Musznicki*, Jean-Luc Schanen[†], Pierre Granjon[‡], Piotr J. Chrzan*

*Politechnika Gdańska, Wydział Electrotechniki i Automatyki KEiME,

ul Sobieskiego 7, 80-216 Gdansk, pmusz@ely.pg.gda.pl

[†]Laboratoire d'Electrotechnique de Grenoble,

UMR 5529 INPG/UJF – CNRS, ENSIEG BP 46 - 38402 Saint-Martin-d'Hères Cedex, jean-luc.schanen@leg.ensieg.inpg.fr

[‡]Laboratoire des Images et des Signaux,

INPG, BP46, 38402 St Martin d'Hères, pierre.granjon@lis.inpg.fr

Abstract—This paper describes how the use of a specific signal processing method can help estimating and understanding the Electromagnetic Interference (EMI) generation of a switched mode power supply. It provides equivalent system between each independent disturbance source and the actual EMI signal. To identify this system, the *Wiener filtering* method is applied. The voltage source inverter switching states are redefined in the new way. Transfer function between each source of disturbance and disturbance is derived. Using this approach, the tool for fast EMI estimation and prediction is given.

I. INTRODUCTION

It has been well recognized that switching phenomena in power electronics converters are at the origin of EMI generation. The reduction of this emission to meet the international standards necessitates better understanding of EMI generation and propagation process. Several authors have tried to investigate this aspect, using various experiments and/or simulations:

- simulations of whole circuit with many simplification in parasitic calculation [1], [2], [3],
- estimation with simply schema including only the most important components [7],[9].

In many papers, in order to forecast perturbation authors use only one transfer function between switch and the line impedance stabilization network (LISN) voltage [7], [10] what is large simplification and in some cases can gives incorrect results. In this paper the new technique of fast EMI predicting method, which allows a fast and more accurate estimation of the EMI emission effects of a power electronic application, is presented. Starting from digital signal processing basis, and aims to determine the contribution to perturbations level, due to switch turn on and turn off. This digital signal processing method is based on powerful Wiener filtering approach [4], which links the source of disturbances and noise measured on LISN.

In this way, EMI behavior of power electronic inverter in the range of conducted perturbation frequency is represented by the system, which contains transfer functions between semiconductor devices and perturbations. This allows to quantify the electromagnetic disturbance of

each switch (MOSFET, IGBT, diode), to estimate the propagation path of this disturbance at each time and also find the role of the disturbance source on the global EMI generation and propagation.

II. SPECIFYING INVERTER STATES

Perturbation from power electronic converters are generated during semiconductors turn on or turn off . The fast changing voltage on one of circuit elements is the reason for perturbation that appears and can be registered on the LISN. Standardize LISN is typically used for perturbation measurements generated in power electronic applications. The level and waveforms of perturbations depend not only on voltage (dv/dt) and current (di/dt) rise or fall time, but also propagation path has influence on it. Parasitics of all components can not be neglect, including parasitic capacitances and inductances of semiconductors and passive components, inductance of connection and conducting tracks and also capacitances to the ground.

In this method, the following assumption have been adopted:

- perturbation is the result of commutation of only one of switch, but level and waveform of perturbations strongly depend on state of residual semiconductors,
- transistors in parallel branches can not be switch in exactly the same time, what is quite rare in modern power electronic applications.

The perturbation pathes can be different owing to various parasitics which take a part in propagation. The waveform during commutation of first transistor, when neighboring switch is open, is not the same with closed neighboring switch, because values of parasitic capacitances and propagation path are different. The states of all semiconductor devices have influence on perturbation level. So, it can be concluded that the level of perturbation generated during commutation of one switch is strongly depended on states of all inverter switches.

Therefore the transfer function between source of perturbation and perturbation registered on the LISN is depended on all circuit parameters and state of inverter. It can be also noticed that values of all components are

time invariant during typical inverter operation, but only inverter state is changing.

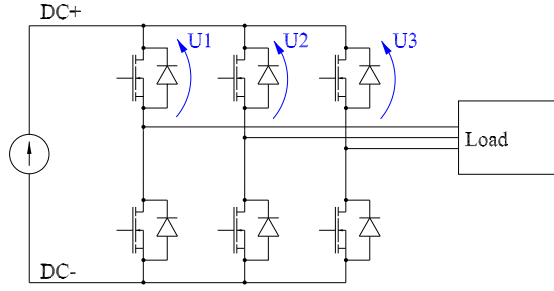

Fig. 1. Voltages used to inverter state definition.

Normally, 8 states of three phase bridge inverter can be defined in accordance with voltage space vector which is produced on the output of converter. However, this approach is not useful for EMI analyzes, because it is impossible to find which semiconductor device is a source of disturbances. In this paper, we defined new method of states determination based on voltages between one of busbar (DC+ or DC-) and midpoints of three parallel inverter leg (fig. 1). These voltages can be easily obtained by computer simulations and they are available for measurement in a large majority of real applications. The proposed approach allows to define 12 states and determinate of 12 transfer function linking voltages across the switches and 50Ω LISN resistor, to forecast perturbation waveforms.

When commutation happens in first leg (transistor or diode is turn on or turn off), the other semiconductor devices are on (low voltage) or off (high voltage). Regarding only U_2 and U_3 level, four different inverter state can be defined for one switch commutation ($dU_1/dt \neq 0$).

TABLE I
DC/AC HARD SWITCHING CONVERTER STATES DEFINITION FOR U_1 CHANGE.

state	U_1	U_2	U_3
1	change	high	high
2	—	high	low
3	—	low	high
4	—	low	low

Analogously, next states are defined for commutations in remaining legs, when U_2 and U_3 are changing (table II). To conclude for accurate forecasting of EMI perturbations generated in hard switching inverter, the 12 states should be distinguished for different propagation paths. Moreover, as perturbations spread in different way, when the switch is turn on and turn off. It provides that total number of states should be doubled, what finally leads to the 24 states.

This method can be used to reconstruct inverter perturbation waveforms, for all kind of modulation. There

TABLE II
DC/AC HARD SWITCHING CONVERTER STATES DEFINITION FOR U_2 AND U_3 CHANGE.

state	U_1	U_2	U_3
5	high	change	high
6	high	—	low
7	low	—	high
8	high	—	low
9	high	high	change
10	high	low	—
11	low	high	—
12	high	low	—

is no need to check, which semiconductor - transistor or diode - actually conduct the current in chosen inverter leg. Furthermore, dead time phenomena is taken into account.

III. WIENER FILTER IN EMI PREDICTING - THEORY

The main assumptions of *Wiener filtering* theory are as follows:

- the system represented by one *Wiener filter* is linear and time-invariant,
- noise from other sources is not correlated with the main signals.

In order to find transfer function of the system, at least two signals are needed: input signal (source of disturbances) and output signal (disturbances measured).

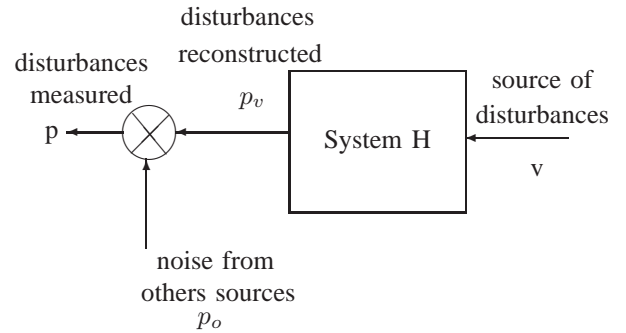

Fig. 2. Wiener filter theory.

It is known that signals from source (v) and disturbances measured (p) are correlated; moreover there is no correlation between signal from source and others noises. In the frequency domain, the *Wiener filter* output $P_v(j\omega)$ is the product of the input signal $V(j\omega)$ and the filter frequency response $H(j\omega)$:

$$P_V(j\omega) = H(j\omega)V(j\omega) \quad (1)$$

It can be proved that transfer function of the system could be obtained using the power spectrum of $v(\tau)$ (equation 3), and the cross-power spectrum of $v(\tau)$ and $p(\tau)$ respectively (equation 4). The least mean square error Wiener filter in the frequency domain is given as:

$$H(j\omega) = \frac{S_{vp}(j\omega)}{S_{vv}(j\omega)} \quad (2)$$

where:

$$S_{vv}(j\omega) = E[V(j\omega)V^*(j\omega)] \quad (3)$$

$$S_{vp}(j\omega) = E[P(j\omega)V^*(j\omega)] \quad (4)$$

Link between input and output signals can be also obtain in time domain by defining impulse response of the system $H(\tau)$ and convolution of $v(t)$ and $p(t)$. In order to forecast EMI disturbances in DC/AC hard switching converter using *Wiener filtering* method, 24 transfer functions should be calculated (fig. 3) for turn on and turn off for each of 12 inverter states (Table I and II)

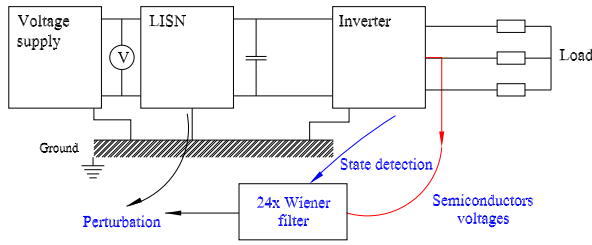

Fig. 3. Wiener filters and inverter

IV. VALIDATION OF WIENER FILTER METHOD

In order to validate the *Wiener filter* EMI estimation for hard switching inverter, data from accurate simulation has been used. The simulations have been performed with the aid of circuit simulator *Saber*®. The simulated schema contains all circuit component models and connections including parasitic inductances and capacitances, using the same approach as in previous work for DC/DC boost converter [2]. The switches and LISN voltages waveform have shapes reflecting real application. These signals are sufficient to prove correct operation of *Wiener filter* and that seems to work properly using measured data from real hard switching inverter.

In order to apply the *Wiener filtering* method, the new software has been built in *Matlab*® environment. The input signals are the inverter switch voltages U_1 , U_2 and U_3 from figure 1. The result of disturbances reconstruction is presented on figure 4.

It can be noticed that signals obtained with *Wiener filter* are almost the same like the real ones. In this case, the normalized estimation error is 3.5 %. The inaccuracy can be explained by perturbations not correlated with the input voltages, coming from another sources like load or others circuit components. In many digital signal processing algorithms, not sufficient number of samples can be a problem. In few situation DC/AC converter can stay in

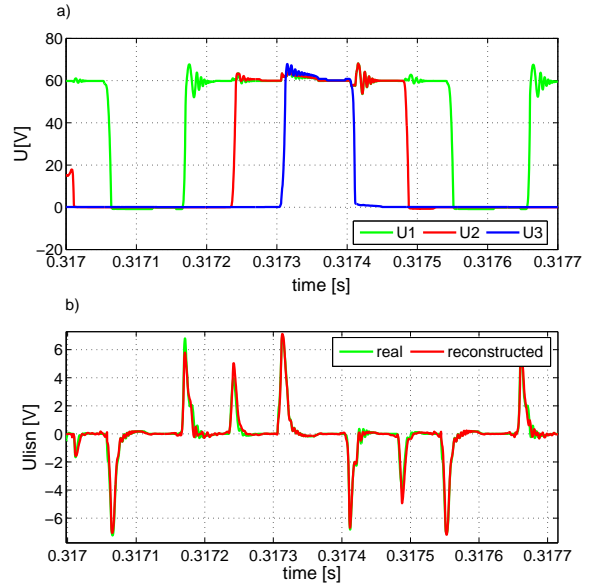

Fig. 4. Semiconductors and LISN voltage waveforms

some states for a short time and it cause low number of samples for these blocks.

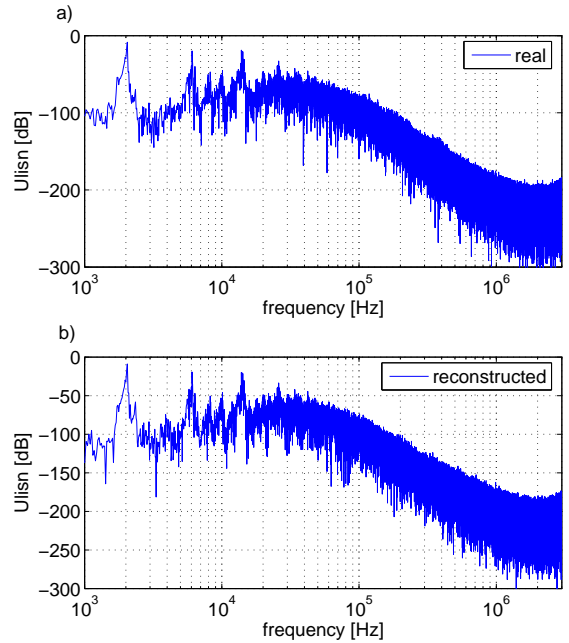

Fig. 5. Spectra of the LISN voltage a) simulation b) Wiener filter estimation

Saber® simulations have been effected with variable calculating step, producing non-regular number of samples per estimation period. Using data from measurement as an input signals, suitable number of samples should be assured in measurement equipment. Inappropriate Wiener filtering results can be observe on spectra, specially in high frequencies range. Comparative results of the EMI simulation and estimation in the frequency domain are

shown in figure 5. In high frequencies range above 20 MHz, is indicated approximate estimation error of 2%. In this case reconstruction of perturbations is quite precise, excepting this number samples discrepancy. In comparison with "typical" simulations, which need lots of computing time, powerful simulators and fast computer, *Wiener filtering* method is more effectiveness and can be realizable in short time.

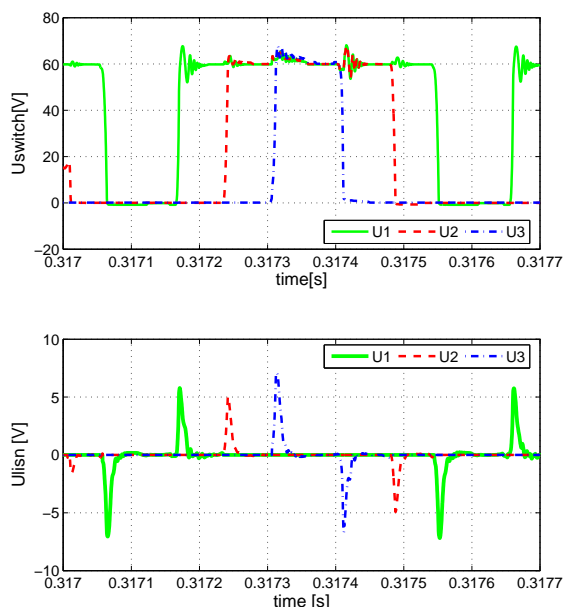

Fig. 6. Perturbations source identification

The identification of source disturbances can be done directly with this method: each part of perturbation waveform can be linked with the corresponding inverter switch commutation voltage (fig. 6). It allows to separate perturbation generated by each particular switch. This knowledge is useful to optimization of geometrical layout and reductions of EMI emissions.

The main objective that the level of perturbations depend on inverter states, we try to prove on figure 7. Considering transfer functions of *Wiener filter*, of only one switch (U_1), are different for 4 inverter states (table I). The shape of transfer function depend on propagation path and participation of all parasitics components. In spite of similar envelopes, the waveforms are completely different. On figure 7 it is also shown the different resonance frequencies which induce amplification of electromagnetic perturbations in some particular frequency bands.

Accurate EMI analysis for hard switching inverters should include all semiconductor states. However sometimes, the number of states can be smaller than proposed in this paper, because of existing symmetry in real power electronic applications.

Once the set of the transfer functions are known, it is possible to change the shape of source waveforms (voltages or current of semiconductors), to check how it influences the perturbations shape and level.

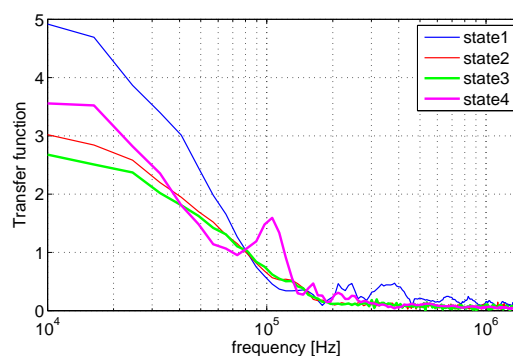

Fig. 7. Transfer functions for different states of inverter (table I p1-4)

V. CONCLUSION

Wiener filtering method allows to estimate with sufficient accuracy EMI conducted emission in power electronics converters. Moreover for EMI estimation, in hard switching inverter it is necessary to use several filters, because the level and waveform of perturbations strongly depend on system state. In this paper, method based on 24 states is presented, that allows to reconstruct voltage registered on the LISN. The analysis confirm that propagation path and participation of inverter components are different for different state of inverter. Identification of source disturbances allows to link voltages on switches with perturbation, which commutation is the reason of this perturbation. It is also possible to derive transfer function (impulse response in time domain) relating the cause and disturbances, that allows better understanding of EMI behavior of DC/AC hard switching inverter including propagation phenomena. Moreover, this technique can be useful for predicting EMI with different command laws, without any real implantation or long simulation.

REFERENCES

- [1] F.Costa, E.Laboure, F.Forest, S.Lefebvre „*Quantification and minimization of conducted interferences generated in hard switching and zero current switching cell*”, APEC'94, 13-17 Feb 94.
- [2] P.Musznicki, J.L.Schanen, B.Allard, P.J.Chrzan „*Accurate modeling of layout parasitic to forecast EMI emitted from a DC-DC converter*”, PESC 04, Aachen, Germany.
- [3] L Rossetto, G.Spiazzi, P Tenti „*Boost PFC with 100 Hz switching frequency providing output voltage stabilization and compliance with EMC standards*”, IEEE trans on IAS, Vol 36 n° 1, Jan-Feb 2000
- [4] B. Widrow et al., „*Adaptive noise cancelling: principle and applications*”, IEEE Proceedings, Vol 63, Dec. 1975, pp. 1692-1716.
- [5] B.Revol, J.Roudet, J.L.Schanen, P.Loizelet „*EMI study of a three phase inverter-Fed Motor Drives*”, IAS 04, Seattle, October 2004
- [6] J.C.Cr ebier, J.Roudet, J.L.Schanen, „*EMI analysis of single phase PFC boost rectifier in the frequency domain*”, Revue Internationale de G enie Electrique, Vol2 n° 2 1999, pp 215-241.
- [7] J.L.Schanen, L.Jourdan, J.Roudet „*Layout optimization to reduce EMI of a SMPS*”, Pesc 2002, Cairns, Queensland, Australia.
- [8] S. V. Vaseghi „*Advance digital signal processing and noise reduction*” 2000 John Wiley & Sons Ltd
- [9] P. Musznicki, J.L. Schanen, P. Granjon. P.J. Chrzan „*Better understanding EMI generation of power converters*” PESC 2005 June 2005, Recife, Brazil
- [10] M. Cacciato, A. Consoli, G. Scarcella, S. De Caro, A. Testa „*High Frequency Modeling of DC/AC Converters*” EPE 2005 September 2005 Dresden Germany