



HAL
open science

Reiterated homogenization of a cavitation problem in thin films mechanics

Sébastien Martin

► **To cite this version:**

Sébastien Martin. Reiterated homogenization of a cavitation problem in thin films mechanics. 2006. ⟨hal-00020180⟩

HAL Id: hal-00020180

<https://hal.science/hal-00020180v1>

Preprint submitted on 7 Mar 2006

HAL is a multi-disciplinary open access archive for the deposit and dissemination of scientific research documents, whether they are published or not. The documents may come from teaching and research institutions in France or abroad, or from public or private research centers.

L'archive ouverte pluridisciplinaire **HAL**, est destinée au dépôt et à la diffusion de documents scientifiques de niveau recherche, publiés ou non, émanant des établissements d'enseignement et de recherche français ou étrangers, des laboratoires publics ou privés.



HAL Authorization

REITERATED HOMOGENIZATION OF A CAVITATION PROBLEM IN THIN FILMS MECHANICS*

S. MARTIN¹

Abstract. This paper deals with the coupling of two major problems in lubrication theory: cavitation phenomena and roughness of the surfaces in relative motion: cavitation is defined as the rupture of the continuous film due to the formation of air bubbles, leading to the presence of a liquid-gas mixture. For this, the Elrod-Adams model (which is a pressure-saturation model) is classically used to describe the behavior of a viscous cavitated flow in the lubrication framework. However, in practical situations, the surfaces of the devices are rough, due to manufacturing processes which induce defaults. Thus, we study the behavior of the solution, when highly oscillating roughness effects on the rigid surfaces occur. In particular, we deal with the reiterated homogenization of this elliptic-hyperbolic problem, using periodic unfolding methods. We define a homogenized problem in the most general case, pointing out the fact that it leads to a unusual form (when compared to the initial one). We also state that, under some assumptions on the roughness patterns, the difficulties vanish, leading to a well-posed homogenized problem. A numerical simulation evidences the behavior of the solution: although the pressure tends to a smooth one, the saturation oscillations are not damped. This does not prevent from defining an equivalent homogenized saturation but only points out the anisotropic effects on the saturation function in cavitated areas.

Résumé. On s'intéresse au couplage de deux problèmes majeurs en théorie de la lubrification: d'une part, les phénomènes de cavitation et, d'autre part, les rugosités des surfaces qui définissent le mécanisme : la cavitation correspond à la rupture du film mince lubrifié, en raison de la formation de bulles de gaz, ce qui conduit à considérer la présence d'un mélange liquide-gaz dans certaines zones de l'écoulement. Pour cela, le modèle d'Elrod-Adams (qui est un modèle en pression-saturation) est très largement utilisé en mécanique afin de décrire l'écoulement entre deux surfaces proches en mouvement relatif, lorsque la cavitation intervient. En pratique, les surfaces sont rugueuses, en raison des procédés de fabrication qui induisent, volontairement ou non, des défauts de surfaces. Nous nous intéressons donc au comportement de la solution lorsque ces effets de rugosités sont importants. En particulier, on s'intéresse à l'homogénéisation réitérée du problème elliptique-hyperbolique (modèle d'Elrod-Adams), en utilisant la méthode d'éclatement périodique. Nous définissons un problème homogénéisé dans le cas général, en soulignant le fait qu'il possède une structure inhabituelle (par rapport au problème initial). Nous montrons également que, sous des hypothèses supplémentaires sur les rugosités, ces difficultés disparaissent : le problème homogénéisé est alors bien posé. Par ailleurs, des tests numériques illustrent le comportement de la solution : alors que la pression converge vers une pression régulière, les oscillations de la saturation ne sont pas amorties. Ceci ne nous empêche pas de définir une saturation homogénéisée mais souligne les effets d'anisotropie qui interviennent dans le couplage micro- macro- au niveau de la saturation et des zones cavitées.

* *The author is very grateful to D. Cioranescu, for fruitful discussions on periodic unfolding methods, and would like to thank also G. Bayada and C. Vázquez for many reasons.*

¹ INSA de Lyon / ICJ, CNRS-UMR 5208, 21 av. Jean Capelle, 69621 Villeurbanne cedex, France. sebastien.martin@insa-lyon.fr

INTRODUCTION

The Reynolds equation has been used for a long time to describe the behavior of a viscous flow between two close surfaces in relative motion (see [27] for historical references). The transition of the Stokes equation to the Reynolds equation has been proved by Bayada and Chambat in [8]. In dimensionless coordinates, it can be written as

$$\operatorname{div}(h^3 \nabla p) = \frac{\partial}{\partial x_1}(h),$$

where p is the pressure distribution, and h the gap between the two surfaces (h is assumed to be a regular positive function). Nevertheless, this modelling does not take into account cavitation phenomena: cavitation is defined as the rupture of the continuous film due to the formation of gas bubbles and makes the Reynolds equation no longer valid in the cavitation area. In order to make it possible, we use the Elrod-Adams model, which introduces the hypothesis that the cavitation region is a liquid-gas mixture and an additional unknown θ (the saturation of liquid in the mixture) (see [14, 16, 17, 19]). The model still relies on the Reynolds equation:

$$\operatorname{div}(h^3 \nabla p) = \frac{\partial}{\partial x_1}(\theta h), \quad (1)$$

$$p \geq 0, \quad \theta \in H(p), \quad (2)$$

where H denotes the Heaviside graph. Here, the vapor pressure has been taken to 0. In particular, we may find that a free boundary separates two different areas:

- ▷ in the saturated regions, $p > 0$, $\theta = 1$. In particular, the classical Reynolds equation is recovered.
- ▷ in cavitated regions, $p = 0$, $0 \leq \theta \leq 1$, corresponding to partial lubrication.

Thus, θ describes the local ratio of the liquid phase between the two surfaces. This model is widely used in tribology and appears to give satisfactory results with respect to mechanical experiments. Its interest also relies on the fact that it is a mass-preserving model, unlike some others such as the variational inequalities model.

The effects of the surface roughness on the behavior of a thin film flow has long been the subject of intensive studies, which have gained an increasing attention from 1960 since it was thought to be an explanation for the unexpected load support in bearings. The goal of the so-called homogenization process is to consider an equivalent average problem (with smooth coefficients) whose solution can be computed easily: indeed, the introduction of small parameters, for the description of the roughness patterns, leads to heavy computational costs which can be avoided by considering the asymptotic problem. The effect of periodic roughness on the behavior of hydrodynamic magnitudes has been treated in numerous works depending on the lubrication regimes: let us mention the works of Patir and Cheng [26] for the linear case (without cavitation), Jai [20] for compressible thin films flows, Bayada and Faure [10] for a cavitated flow using a variational inequalities model. Some of these theoretical studies include numerical examples which show how significant pressure perturbations appear, due to the presence of surface asperities. So far, in the framework of cavitation regimes, this homogenization procedure had not been used with the more realistic Elrod-Adams model until recently [11, 12] (for both hydrodynamic and elastohydrodynamic regimes). It has appeared that anisotropic effects have to be taken into account in the coefficients of the so-called homogenized equation, but also in the description of the macroscopic saturation function.

However, in all these works, the roughness patterns were modelled by only one typical (periodic) pattern, corresponding to one type of defaults. This assumption is reasonable for many mechanical applications, but it lacks relevance in other situations: indeed, manufacturing processes may lead to different defaults, characterized by different average sizes and periods. Another fact is to consider that the roughness patterns may be introduced in a voluntary way, the motivation for this being related to shape optimization of the surfaces, load experiments and control of the friction. Thus, it is the purpose of this paper to focus on the influence of the roughness effects in the framework of reiterated homogenization dealing with a realistic model of cavitated thin films flow: in particular, we take into account patterns modelled by two different scales (namely ε and ε^2). This

leads to coupling effects between the microscopic and macroscopic scales ε^2 , ε and 1.

The paper is organized as follows:

- Section 1 is devoted to the mathematical formulation of the lubrication problem: we briefly present the Elrod-Adams problem and related mathematical results.
- Section 2 is a preliminary section which briefly describes the periodic unfolding technique.
- Section 3 deals with the homogenization process: we first establish the micro- macro- coupling equations and state an uncomplete form of the homogenized problem: anisotropic phenomena on the saturation appear. Then, in order to complete the homogenized problem, we introduce additional assumptions that lead us to consider particular but realistic cases: considering a separation of the micro- variables on the gaps allows us to completely solve the difficulties.
- Section 4 presents a numerical simulation which illustrates the main results of the previous section.

1. MATHEMATICAL FRAMEWORK FOR THE CAVITATION PROBLEM

Let us present the mathematical formulation of the cavitation problem and related results: we consider a rectangular domain $\Omega =]-l_1, l_1[\times]-l_2, l_2[$; Γ_\star denotes the boundary $\{-l_1\} \times]-l_2, l_2[$ and $\Gamma = \partial\Omega \setminus \Gamma_\star$ (see FIG.1). This configuration is related to a specific type of boundary conditions:

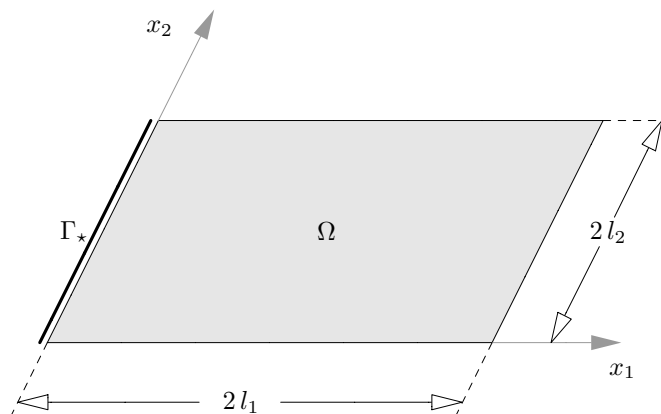

FIGURE 1. Domain

$$p = 0 \quad \text{on } \Gamma, \quad (3)$$

$$\theta h - h^3 \frac{\partial p}{\partial x_1} = Q \quad \text{on } \Gamma_\star. \quad (4)$$

Here, Q denotes the input flow, which may be classically normalized as

$$Q = \theta_\star \frac{1}{2l_2} \int_{-l_2}^{l_2} h(-l_1, \cdot),$$

with $\theta_\star \in [0, 1]$. However, the study may be easily generalized to other types of boundary conditions. Equations (1)–(4) may be analyzed with the following weak formulation:

$$(\mathcal{P}_\theta) \begin{cases} \text{Find } (p, \theta) \in V \times L^\infty(\Omega) \text{ such that:} \\ \int_\Omega h^3 \nabla p \nabla \phi = \int_\Omega \theta h \frac{\partial \phi}{\partial x_1} + \int_{\Gamma_\star} Q \phi, \quad \forall \phi \in V \\ p \geq 0, \quad \theta \in H(p), \quad \text{a.e.,} \end{cases}$$

where the functional space V is defined as $V = \{v \in H^1(\Omega), v|_\Gamma = 0\}$.

Existence and uniqueness of the solution for problem (\mathcal{P}_θ) have been studied by many authors, for various configurations depending on the shape of the gap or boundary conditions [4–7, 24, 29]. However, we have:

Theorem 1.1 (Existence and uniqueness). *Problem (\mathcal{P}_θ) admits a unique solution.*

Proof. Complete details of the proof may be found in [4, 24] for different boundary conditions. The full result is also stated in [29] when the gap only depends on x_1 . However, the result is still valid without any geometrical assumption.

- Existence of a solution is based on the analysis of a penalized version of the problem. Defining $H_\eta(z) = (z/\eta) \mathbf{1}_{[0, \eta]} + \mathbf{1}_{[\eta, +\infty[}$ (which mimics the Heaviside graph), we consider:

$$(\mathcal{P}_\eta) \begin{cases} \text{Find } p_\eta \in V, \text{ such that:} \\ \int_\Omega h^3 \nabla p_\eta \nabla \phi = \int_\Omega H_\eta(p_\eta) h \frac{\partial \phi}{\partial x_1} + \int_{\Gamma_\star} Q \phi, \quad \forall \phi \in V \\ p_\eta \geq 0, \quad \text{a.e.} \end{cases}$$

It can be proved (see the previous references) that (\mathcal{P}_η) admits a unique solution. Existence of a solution for problem (\mathcal{P}_θ) is obtained by passing to the limit on the penalization parameter η .

- Uniqueness of the solution is based on the doubling variable method, adapted from the one developed by Kruřkov [21]. It allows to state a comparison result: *For $i \in \{1, 2\}$, let (p_i, θ_i) be a solution of (\mathcal{P}_θ) corresponding to a boundary datum Q_i on Γ_\star . If $Q_1 \leq Q_2$, then $p_1 \leq p_2$.* This ensures the uniqueness of the pressure. As a consequence, uniqueness of the saturation is straightforward. \square

Our main purpose will focus on the behavior of the solution when the gap h is highly oscillating, due to roughness patterns on the rigid surfaces. Thus, in the next section, we briefly present a mathematical technique which is adapted to the asymptotic analysis of nonlinear problems. Then, it will apply to the description of the roughness effects on the thin film flow.

2. PRELIMINARY: PERIODIC UNFOLDING METHOD AND REITERATED HOMOGENIZATION

The periodic unfolding method has been introduced by Cioranescu, Damlamian and Griso [15]. It combines a dilatation technique and averaging approximations, reducing the asymptotic analysis to the study of weak convergences in appropriate spaces. This mathematical tool, which applies to multiscale problems in a very simple way, has strong links with the multiscale convergence technique which was introduced by Nguetseng [25], and further developed by Allaire [1], Lukkassen, Nguetseng and Wall [22].

Let Ω be an open bounded set in \mathbb{R}^d , $d \in \mathbb{N}^\star$, and let $Y =]0, 1[^d$ denote the reference cell (eventually, Z will also denote the reference cell). Then, for any $x \in \mathbb{R}^d$, $[x]_Y \in \mathbb{Z}^d$ denotes the unique element such that $x - [x]_Y$ belongs to Y .

Definition 2.1. Let $\tilde{\Omega}_n = \Omega \times Y^n$, $n \in \mathbb{N}$, with $\tilde{\Omega}_0 = \Omega$. The unfolding operator

$$\mathcal{T}_\varepsilon : \begin{array}{ccc} L^2(\tilde{\Omega}_n) & \rightarrow & L^2(\tilde{\Omega}_{n+1}) \\ w & \rightarrow & \mathcal{T}_\varepsilon(w) \end{array}$$

modifies any function $w \in L^2(\tilde{\Omega}_n)$, extended by 0 outside $\tilde{\Omega}_n$, as follows:

- if $n = 0$, $\mathcal{T}_\varepsilon(w)(x, y) = w\left(\varepsilon \left[\frac{x}{\varepsilon}\right]_Y + \varepsilon y\right)$,
- if $n \geq 1$, $\mathcal{T}_\varepsilon(w)(x, y^{(1)}, \dots, y^{(n+1)}) = w\left(x, y^{(1)}, \dots, y^{(n-1)}, \left[\frac{y^{(n)}}{\varepsilon}\right]_Y + \varepsilon y^{(n+1)}\right)$.

This definition leads, in a natural way, to reiterated unfolding operators (of any order $k \in \mathbb{N}^*$)

$$\mathcal{T}_{\delta_k \circ \delta_{k-1} \circ \dots \circ \delta_1} : L^2(\tilde{\Omega}_n) \rightarrow L^2(\tilde{\Omega}_{n+k}),$$

defined by

$$\mathcal{T}_{\delta_k \circ \delta_{k-1} \circ \dots \circ \delta_1} = \mathcal{T}_{\delta_k} \circ \mathcal{T}_{\delta_{k-1}} \circ \dots \circ \mathcal{T}_{\delta_1}.$$

Example 2.2. Let us consider some function $f \in L^2(\Omega; C_{\sharp}^1(Y)^2)$ and let us define $f_{\delta\varepsilon}$ by:

$$f_{\delta\varepsilon}(x) = f\left(x, \frac{x}{\varepsilon}, \frac{x}{\delta\varepsilon}\right).$$

Then, we may observe that:

- The unfolding operator $\mathcal{T}_\varepsilon : L^2(\Omega) \rightarrow L^2(\Omega \times Y)$ does not see the oscillations at scale $\delta\varepsilon$: indeed,

$$\mathcal{T}_\varepsilon(f_{\delta\varepsilon})(x, y) = f\left(x, y, \frac{y}{\delta}\right),$$

which does not outline the oscillating periods induced by the parameter δ .

- The reiterated unfolding operator $\mathcal{T}_{\delta \circ \varepsilon} : L^2(\Omega) \rightarrow L^2(\Omega \times Y \times Z)$ allows to capture the oscillatory effects at both scales ε and $\delta\varepsilon$: indeed,

$$\mathcal{T}_{\delta \circ \varepsilon}(f_{\delta\varepsilon})(x, y, z) = f_{\delta\varepsilon}\left(\varepsilon \left[\frac{x}{\varepsilon}\right]_Y + \varepsilon \delta \left[\frac{y}{\varepsilon}\right]_Z + \varepsilon \delta z\right) = f(x, y, z),$$

leading to an effective (but artificial) separation of the scale effects.

Proposition 2.3 (Cioranescu, Damlamian, Griso [15]).

- (i) Let u_ε be a bounded sequence in $L^2(\Omega)$. Then, there exists $u_0 \in L^2(\Omega \times Y)$ such that, up to a subsequence,

$$\mathcal{T}_\varepsilon(u_\varepsilon) \rightharpoonup u_0, \quad \text{in } L^2(\Omega).$$

- (ii) Let u_ε be a bounded sequence in $H^1(\Omega)$, which weakly converges to a limit $u_0 \in H^1(\Omega)$. Then, $\mathcal{T}_{\varepsilon \circ \dots \circ \varepsilon}$ denoting the reiterated unfolding operator of order $k \in \mathbb{N}^*$, one has, up to subsequences:

$$\mathcal{T}_{\varepsilon \circ \dots \circ \varepsilon}(u_\varepsilon) \rightarrow u_0, \quad \text{in } L^2(\tilde{\Omega}_k),$$

and there exists functions $u_i \in L^2(\tilde{\Omega}_{i-1}; H_{\sharp}^1(Y)/\mathbb{R})$ ($i \in \{1, \dots, k\}$), such that

$$\mathcal{T}_{\varepsilon \circ \dots \circ \varepsilon}(\nabla u_\varepsilon) \rightharpoonup \nabla u_0 + \sum_{i=1}^k \nabla_{y^{(i)}} u_i, \quad \text{in } L^2(\tilde{\Omega}_k).$$

Proposition 2.4 (Cioranescu, Damlamian, Griso [15]). One has the following integration formulas

$$\int_{\tilde{\Omega}_n} w = \int_{\tilde{\Omega}_{n+1}} \mathcal{T}_{\delta_1}(w) = \dots = \int_{\tilde{\Omega}_{n+k}} \mathcal{T}_{\delta_k \circ \dots \circ \delta_1}(w), \quad \forall w \in L^1(\tilde{\Omega}_n).$$

Now, in the next section, we apply the periodic unfolding technique to the lubrication problem.

3. REITERATED HOMOGENIZATION OF THE PROBLEM

Now let us introduce the roughness patterns. The effective gap is now described by a nominal regular thickness to which one must add the roughness defaults around the average gap. Thus, we consider that the effective gap is described by:

$$h_\varepsilon(x) = h\left(x, \frac{x}{\varepsilon}, \frac{x}{\varepsilon^2}\right), \quad (5)$$

where $h \in L^\infty(\Omega, C_{\sharp}^1([0, 1]^2))$ satisfies the additional assumption:

$$\exists \underline{h}, \bar{h}, \quad 0 < \underline{h} \leq h_\varepsilon \leq \bar{h}.$$

This assumption leads to consider two roughness scales ε and ε^2 . Although the coupling of the micro- macro- scales has been investigated in [12] in the case of one single roughness scale, the definition of the gap given by Equation (5) leads to another difficulty, which relies on the coupling of micro- macro- scales but also micro- micro- scales. However, the corresponding initial problem should be read as:

$$(\mathcal{P}_\theta^\varepsilon) \begin{cases} \text{Find } (p_\varepsilon, \theta_\varepsilon) \in V \times L^\infty(\Omega) \text{ such that:} \\ \int_\Omega h_\varepsilon^3 \nabla p_\varepsilon \nabla \phi = \int_\Omega \theta_\varepsilon h_\varepsilon \frac{\partial \phi}{\partial x_1} + \int_{\Gamma_\star} Q \phi, \quad \forall \phi \in V \\ p_\varepsilon \geq 0, \quad \theta_\varepsilon \in H(p_\varepsilon), \quad \text{a.e.} \end{cases}$$

Our goal is to describe the asymptotic behavior of $(p_\varepsilon, \theta_\varepsilon)$. For this, we study the convergence of the solution and determine some tractable homogenized equations satisfied by the limit functions, by means of the periodic unfolding method.

3.1. Micro- macro- decomposition

Proposition 3.1. *There exists $(p_0, p_1, p_2) \in V \times L^2(\Omega; H_{\sharp}^1(Y)/\mathbb{R}) \times L^2(\Omega \times Y; H_{\sharp}^1(Z)/\mathbb{R})$ and $\theta_0 \in L^2(\Omega \times Y \times Z)$ such that, up to a subsequence, the following convergences hold in $L^2(\Omega \times Y \times Z)$:*

$$\begin{aligned} \bullet \quad \mathcal{T}_{\varepsilon \circ \varepsilon}(p_\varepsilon) &\rightharpoonup p_0 \\ \bullet \quad \mathcal{T}_{\varepsilon \circ \varepsilon}(\nabla p_\varepsilon) &\rightharpoonup \nabla p_0 + \nabla_y p_1 + \nabla_z p_2 \\ \bullet \quad \mathcal{T}_{\varepsilon \circ \varepsilon}(\theta_\varepsilon) &\rightharpoonup \theta_0 \end{aligned}$$

Proof. It can be easily stated that p_ε (resp. θ_ε) is bounded in $H^1(\Omega)$ (resp. $L^2(\Omega)$). Then, by Proposition 2.3, the convergence results are straightforward. \square

Proposition 3.2. *$p_0 \geq 0$ and $\theta_0 \in H(p_0)$ a.e.*

Proof. In the case of non-reiterated homogenization of the problem (i.e. when the gap h does not depend on the variable z), this has been stated in [11, 12], using the two-scale convergence technique or the periodic unfolding method. However, it can be extended to reiterated homogenization:

• *1st step* - As $p_\varepsilon \geq 0$, $0 \leq \theta_\varepsilon \leq 1$ a.e. and using the definition of the unfolding operator, on has: $\mathcal{T}_\varepsilon(p_\varepsilon) \geq 0$ and $0 \leq \mathcal{T}_\varepsilon(\theta_\varepsilon) \leq 1$ a.e. Using the convergences stated in Proposition 3.1, we obtain, at the limit, the same bounds:

$$p_0(x) \geq 0, \quad 0 \leq \theta_0(x, y, z) \leq 1, \quad \text{for a.e. } (x, y, z) \in \Omega \times Y \times Z.$$

• *2nd step* - Applying the unfolding operator to each side of the equality $p_\varepsilon(1 - \theta_\varepsilon) = 0$ and passing to the limit, we get: $p_0(1 - \theta_0) = 0$ in $L^1(\Omega \times Y \times Z)$. As $p_0 \geq 0$ and $(1 - \theta_0) \geq 0$ a.e., we get:

$$p_0(x) \left(1 - \theta_0(x, y, z)\right) = 0, \quad \text{for a.e. } (x, y, z) \in \Omega \times Y \times Z.$$

Thus, the proof is concluded. \square

Lemma 3.3. *The limit functions satisfy the following micro- macro- decomposition:*

- *Macroscopic equation:*

$$\int_{\Omega} \overline{h^3 (\nabla p_0 + \nabla_y p_1 + \nabla_z p_2)}^{Z \times Y} \nabla \phi = \int_{\Omega} \overline{\theta_0 h}^{Z \times Y} \frac{\partial \phi}{\partial x_1} + \int_{\Gamma_*} Q \phi, \quad \forall \phi \in V \quad (6)$$

- *Microscopic equation at scale ε : for a.e. $x \in \Omega$,*

$$\int_Y \overline{h^3 (\nabla p_0 + \nabla_y p_1 + \nabla_z p_2)}^Z \nabla \psi = \int_Y \overline{\theta_0 h}^Z \frac{\partial \psi}{\partial y_1}, \quad \forall \psi \in H_{\#}^1(Y) \quad (7)$$

- *Microscopic equation at scale ε^2 : for a.e. $(x, y) \in \Omega \times Y$,*

$$\int_Z h^3 (\nabla p_0 + \nabla_y p_1 + \nabla_z p_2) \nabla \varphi = \int_Z \theta_0 h \frac{\partial \varphi}{\partial z_1}, \quad \forall \varphi \in H_{\#}^1(Z) \quad (8)$$

Here, $\overline{\cdot}^Y$ (resp. $\overline{\cdot}^Z$) denotes the average operator on Y (resp. Z) with respect to y (resp. z).

Proof. In the formulation of $\mathcal{P}_{\theta}^{\varepsilon}$, let us consider a test function Φ defined by

$$\Phi(x) = \phi^{(0)}(x) + \varepsilon \phi^{(1)}(x) \psi^{(1)}\left(\frac{x}{\varepsilon}\right) + \varepsilon^2 \phi^{(2)}(x) \psi^{(2)}\left(\frac{x}{\varepsilon}\right) \varphi^{(2)}\left(\frac{x}{\varepsilon^2}\right),$$

with $\phi^{(0)} \in V$, $\phi^{(i)} \in \mathcal{D}(\Omega)$, $\psi^{(i)} \in H_{\#}^1(Y)$ ($i \in \{1, 2\}$), $\varphi^{(2)} \in H_{\#}^1(Z)$.

Then, using the integration formula (see Proposition 2.4) and passing to the limit on ε leads to the micro-macro- decomposition. \square

Now, the goal is to get the homogenized equations, i.e. only macroscopic equations describing the scale effects on the average flow. The general method relies on the possibility to solve local problems describing the coupling effects at the different scales. For this, we first introduce the local problems, whose structure will be justified in the proof of Lemma 3.7:

Definition 3.4 (Local problems at scale ε^2).

Find $\mathcal{V}^{(i)}$ ($i = 1, 2$), α^* , α^0 in $L^2(\Omega \times Y; H_{\#}^1(Z)/\mathbb{R})$, such that, for a.e. $(x, y) \in \Omega \times Y$:

$$\int_Z h^3 \nabla_z \mathcal{V}^{(i)} \nabla_z \varphi = \int_Z h^3 \frac{\partial \varphi}{\partial z_i}, \quad \forall \varphi \in H_{\#}^1(Z) \quad (i = 1, 2) \quad (9)$$

$$\int_Z h^3 \nabla_z \alpha^* \nabla_z \varphi = \int_Z h \frac{\partial \varphi}{\partial z_1}, \quad \forall \varphi \in H_{\#}^1(Z) \quad (10)$$

$$\int_Z h^3 \nabla_z \alpha^0 \nabla_z \varphi = \int_Z \theta_0 h \frac{\partial \varphi}{\partial z_1}, \quad \forall \varphi \in H_{\#}^1(Z) \quad (11)$$

Definition 3.5 (Local problems at scale ε). Let us first define the following coefficients:

$$\mathcal{H}^{(3)} = \overline{h^3 (I - \nabla_z \mathcal{V})}^Z \quad \text{with } \mathcal{V} = \begin{pmatrix} \mathcal{V}^{(1)} \\ \mathcal{V}^{(2)} \end{pmatrix}, \quad \mathcal{H}^0 = \overline{\begin{pmatrix} \theta_0 h \\ 0 \end{pmatrix} - h^3 \nabla_z \alpha^0}^Z, \quad \mathcal{H}^* = \overline{\begin{pmatrix} h \\ 0 \end{pmatrix} - h^3 \nabla_z \alpha^*}^Z.$$

Find $\mathcal{W}^{(i)}$ ($i = 1, 2$), β^* , β^0 in $L^2(\Omega; H_{\sharp}^1(Y)/\mathbb{R})$, such that, for a.e. $x \in \Omega$:

$$\int_Y \mathcal{H}^{(3)} \cdot \nabla_y \mathcal{W}^{(i)} \nabla_y \psi = \sum_{k=1}^2 \int_Y \mathcal{H}_{ki}^{(3)} \frac{\partial \psi}{\partial y_k}, \quad \forall \psi \in H_{\sharp}^1(Y) \quad (i = 1, 2) \quad (12)$$

$$\int_Y \mathcal{H}^{(3)} \cdot \nabla_y \beta^* \nabla_y \psi = \int_Y \mathcal{H}^* \nabla_y \psi, \quad \forall \psi \in H_{\sharp}^1(Y) \quad (13)$$

$$\int_Y \mathcal{H}^{(3)} \cdot \nabla_y \beta^0 \nabla_y \psi = \int_Y \mathcal{H}^0 \nabla_y \psi, \quad \forall \psi \in H_{\sharp}^1(Y) \quad (14)$$

In a natural way, \mathcal{W} will denote $\begin{pmatrix} \mathcal{W}^{(1)} \\ \mathcal{W}^{(2)} \end{pmatrix}$.

Remark 3.6. Let us notice that each local problem admits a unique solution.

Lemma 3.7 (Partial result in the general case). *The main unknowns $(p_0, \theta_0) \in V \times L^\infty(\Omega \times Y \times Z)$ of the limit problem satisfy the following equations*

$$\begin{cases} \int_{\Omega} \mathcal{A} \cdot \nabla p_0 \nabla \phi = \int_{\Omega} \mathcal{B}^0 \nabla \phi + \int_{\Gamma_*} Q \phi, & \forall \phi \in V, \\ p_0 \geq 0, \quad \theta_0 \in H(p_0) & \text{a.e.}, \end{cases}$$

with $\mathcal{A} = h^3 \overline{(I - \nabla_y \mathcal{W}) (I - \nabla_z \mathcal{V})}^{Z \times Y}$ and $\mathcal{B}^0 = \overline{\begin{pmatrix} \theta_0 h \\ 0 \end{pmatrix} - h^3 \nabla_z \alpha^0 - h^3 (I - \nabla_z \mathcal{V}) \cdot \nabla_y \beta^0}^{Z \times Y}$.

Remark 3.8. The proposed result is partial in the sense that it describes the coupling effects of both microscopic and macroscopic functions (p_0 and θ_0), instead of purely macroscopic functions (p_0 and a macroscopic saturation function for instance). Still, as a first step, it allows to understand the structure of the limit problem.

Proof. The analysis first deals with the description of the interaction between the scale effects of order ε^2 , on the one hand, and the scale effects of orders ε and 1, on the other hand. From Equation (8) and Definition 3.4 of the local problems and related solutions, we have:

$$p_2 = -\mathcal{V} (\nabla p_0 + \nabla_y p_1) + \alpha^0, \quad \text{in } L^2(\Omega \times Y; H_{\sharp}^1(Z)/\mathbb{R}), \quad (15)$$

which describes the coupling of the different scales at the lowest scale ε .

Then, we deal with the description of the interaction between the scales of orders ε and 1 (still taking into account the scale effects of order ε^2). For this, we put Equation (15) into Equation (7) which leads, in a very natural way, to consider the local problems and related solutions described in Definition 3.5. Moreover, we obtain:

$$p_1 = -\mathcal{W} \nabla p_0 + \beta^0, \quad \text{in } L^2(\Omega; H_{\sharp}^1(Y)/\mathbb{R}). \quad (16)$$

The last step describes the interaction of the scale effects of order ε^2 and ε at the macroscopic level (scale of order 1). For this, we put Equations (15) and (16) into Equation (6), which concludes the proof. \square

Theorem 3.9 (Homogenized problem). *One possible definition of the homogenized problem is:*

$$(\mathcal{P}_{\theta}^*) \begin{cases} \text{Find } (p_0, \Theta_1, \Theta_2) \in V \times L^\infty(\Omega) \times L^\infty(\Omega) \text{ such that:} \\ \int_{\Omega} \mathcal{A} \cdot \nabla p_0 \nabla \phi = \int_{\Omega} \Theta_i \mathcal{B}_i^* \frac{\partial \phi}{\partial x_i} + \int_{\Gamma_*} Q \phi, & \forall \phi \in V, \\ p_0 \geq 0, \quad p_0 (1 - \Theta_i) = 0, \quad (i = 1, 2), & \text{a.e.}, \end{cases}$$

where \mathcal{A} is defined in Lemma 3.7 and $\mathcal{B}^* = \overline{\begin{pmatrix} h \\ 0 \end{pmatrix} - h^3 \nabla_z \alpha^* - h^3 (I - \nabla_z \mathcal{V}) \cdot \nabla_y \beta^*}^{Z \times Y}$.

Proof. The result is a corollary of Lemma 3.7, in which the coefficients of the right-hand side have been renormalized as follows: $\Theta_i = \mathcal{B}_i^0 / \mathcal{B}_i^*$ ($i \in \{1, 2\}$). \square

Remark 3.10. The homogenized lubrication problem can be considered as a generalized Reynolds-type problem with two saturation functions Θ_i ($i = 1, 2$). Let us notice that if there is no cavitation phenomena (i.e. $p_0 > 0$) then $\Theta_i = 1$: thus, we get the classical homogenized Reynolds equation (without cavitation). But several aspects remain hard to describe:

- (a) The homogenized problem leads us to consider two different saturation functions, since an extra term has to be added (in the x_2 direction of the flow) when comparing the homogenized problem to the initial problem.
- (b) Another point is to consider the fact that the property $0 \leq \Theta_i \leq 1$ is missing, i.e. we cannot guarantee that homogenized cavitation parameters are smaller than 1 in cavitation areas !
- (c) Algorithms are known to solve the smooth problem (see for instance the papers by Alt [3], Bayada, Chambat and Vázquez [9], Marini and Pietra [23]). But how to solve the homogenized problem numerically ? How to treat the two different saturation functions?

Thus, it appears that the homogenized problem (\mathcal{P}_θ^*) deals with saturation functions which lack physical properties in cavitated areas. However, we show that it also admits a class of solutions which have some physical sense:

Theorem 3.11. *The homogenized problem (\mathcal{P}_θ^*) admits at least one solution (p_0, Θ, Θ) with $\Theta \in H(p_0)$ a.e.*

Proof. Consider the penalized version of the problem (which has been defined in the proof of Theorem 1.1), with oscillating coefficients, i.e. the gap being defined by Equation (5):

$$(\mathcal{P}_\eta) \left\{ \begin{array}{l} \text{Find } p_\varepsilon^\eta \in V, \text{ such that:} \\ \int_\Omega h_\varepsilon^3 \nabla p_\varepsilon^\eta \nabla \phi = \int_\Omega H_\eta(p_\varepsilon^\eta) h_\varepsilon \frac{\partial \phi}{\partial x_1} + \int_{\Gamma_\star} Q \phi, \quad \forall \phi \in V \\ p_\varepsilon^\eta \geq 0, \quad \text{a.e.} \end{array} \right.$$

The homogenization of this penalized problem leads us to the following asymptotic problem (for complete details, see [12] in which the study is done when h does not depend on z ; however, the generalization to reiterated homogenization studies is straightforward):

$$(\mathcal{P}_\eta^*) \left\{ \begin{array}{l} \text{Find } p_0^\eta \in V \text{ such that:} \\ \int_\Omega \mathcal{A} \cdot \nabla p_0^\eta \nabla \phi = \int_\Omega H_\eta(p_0^\eta) \mathcal{B}^* \nabla \phi + \int_{\Gamma_\star} Q \phi, \quad \forall \phi \in V, \\ p_0^\eta \geq 0, \quad \text{a.e.} \end{array} \right.$$

The proof is concluded by passing to the limit on η (see the method which has been detailed in [12] and may be easily extended to the reiterated homogenization study). \square

Remark 3.12. The difficulties that we have mentioned may be easily related to the ones which have been presented in [2, 28] in the framework of the dam problem (whose mathematical structure is very near to the one of the lubrication problem). On the one hand, the right-hand side of the homogenized problem \mathcal{B}^0 leads to anisotropic effects on the saturation (see Lemma 3.7 and Theorem 3.9), which lack physical evidence. On the other hand, we have been able to build an isotropic solution to this problem, with physical properties on the saturation. Thus, we are led to the following remarks:

- A naive way to understand these phenomena would be to identify the (possibly unique) isotropic saturation Θ to the weak limit of θ_ε , denoted θ^* and defined by

$$\theta^* = \overline{\theta_0}^{Z \times Y}.$$

But this approach is not relevant: it can be proved that \mathcal{B}^0 differs from $\theta^* \mathcal{B}^*$ except in the saturated regions.

- If (p_0, Θ, Θ) denotes an isotropic solution of the homogenized problem, one can not, in general, have the convergence of θ_ε to Θ (see the counter-example of Alt and Rodrigues [28] for the dam problem, which can be adapted to the lubrication problem), and the question of how to relate \mathcal{B}^0 (which highly depends on θ_0) with $\Theta \mathcal{B}^*$ is not clear.

In fact, we will see, in the following subsection, how it is possible to solve all the mentioned difficulties, under some additional assumptions on the roughness patterns.

3.2. Particular cases

Here, we state that under some assumptions on the roughness patterns, the difficulties vanish: the homogenized problem is well-posed from both mathematical and physical points of view.

Definition 3.13. Let us denote $h_{[ij]}(x, y, z) := h(x, y_i, z_j)$, i.e. $h_{[ij]}$ only depends on x, y_i and z_j ($i, j \in \{1, 2\}$).

Theorem 3.14. *If h can be identified to a function $h_{[ij]}$, then the homogenized problem is:*

$$(\mathcal{P}_\theta^*) \begin{cases} \text{Find } (p_0, \Theta) \in V \times L^\infty(\Omega) \text{ such that:} \\ \int_\Omega \begin{pmatrix} \mathcal{A}_1 & 0 \\ 0 & \mathcal{A}_2 \end{pmatrix} \cdot \nabla p_0 \nabla \phi = \int_\Omega \Theta \mathcal{B}_1^* \frac{\partial \phi}{\partial x_1} + \int_{\Gamma_*} Q \phi, \quad \forall \phi \in V, \\ p_0 \geq 0, \quad \Theta \in H(p_0), \quad \text{a.e.,} \end{cases}$$

the homogenized coefficients being given by TABLE 1). The link between the micro- saturation θ_0 and the macro- (homogenized) saturation Θ is also provided by TABLE 1). Moreover, (\mathcal{P}_θ^*) admits a unique solution.

	$h := h_{[11]}$	$h := h_{[12]}$	$h := h_{[21]}$	$h := h_{[22]}$
\mathcal{A}_1	$\left(\overline{\left(\overline{h^{-3Z}} \right)^Y} \right)^{-1}$	$\left(\overline{\left(\overline{h^{3Z}} \right)^{-1Y}} \right)^{-1}$	$\overline{\left(\overline{h^{-3Z}} \right)^{-1Y}}$	$\overline{\left(\overline{h^{3Z}} \right)^Y}$
\mathcal{A}_2	$\overline{\left(\overline{h^{3Z}} \right)^Y}$	$\overline{\left(\overline{h^{-3Z}} \right)^{-1Y}}$	$\left(\overline{\left(\overline{h^{3Z}} \right)^{-1Y}} \right)^{-1}$	$\left(\overline{\left(\overline{h^{-3Z}} \right)^Y} \right)^{-1}$
\mathcal{B}_1^*	$\frac{\overline{\left(\overline{h^{-2Z}} \right)^{-2Y}}}{\overline{\left(\overline{h^{-3Z}} \right)^{-3Y}}}$	$\frac{\overline{\left(\overline{h^Z} \right)^{-2Y}}}{\overline{\left(\overline{h^Z} \right)^{-3Y}}}$	$\overline{\left(\overline{h^{-2Z}} \right)^Y}$	$\overline{\left(\overline{h^Z} \right)^Y}$
Θ	$\frac{\overline{\left(\overline{\left(\frac{\theta_0}{h^2} \right)^Z \left(\overline{h^{-3Z}} \right)^2} \right)^Y}}{\overline{\left(\overline{h^{-2Z}} \right)^{-2Y}}}$	$\frac{\overline{\left(\overline{\theta_0 h^Z \left(\overline{h^Z} \right)^{-3}} \right)^Y}}{\overline{\left(\overline{h^Z} \right)^{-2Y}}$	$\frac{\overline{\left(\overline{\left(\frac{\theta_0}{h^2} \right)^Z \frac{1}{\overline{h^{-3Z}}} \right)^Y}}{\overline{\left(\overline{h^{-2Z}} \right)^Y}}$	$\frac{\overline{\left(\overline{\theta_0 h^Z} \right)^Y}}{\overline{\left(\overline{h^Z} \right)^Y}}$

TABLE 1. Homogenized coefficients (Part 1) and link between the micro- macro- saturations

Proof. Assumptions on the roughness patterns leads to some particular anisotropy of the scale effects. It allows to solve explicitly the local problems by means of integration. The computations of the coefficients are led following the method used in [12] (with a gap h which does not depend on z), adapted to the reiterated homogenization process. \square

Remark 3.15. A primal "naive" attempt for the determination of the homogenized problem would be to find a set of equations satisfied by the weak limit of $(p_\varepsilon, \theta_\varepsilon)$, namely

$$\left(p_0, \overline{\theta_0}^{Z \times Y} \right).$$

Interestingly, the weak limit of the pressure does appear in the homogenized problem, but the macroscopic homogenized saturation Θ is an anisotropic average of θ_0 , weighted by the roughness effects at different scales and directions.

Remark 3.16. It is interesting to notice that the assumption on the roughness patterns allows us to avoid all the difficulties that we could not overcome in the most general case (see Remark 3.10). In particular, there is one single saturation function with values in $[0, 1]$ and the homogenized problem can be numerically solved using algorithms adapted to the smooth problem.

Remark 3.17. Actually, Theorem 3.14 may be generalized in the following sense: if h may be written as

$$h := h_{[11]} h_{[22]} \quad \text{or} \quad h := h_{[21]} h_{[12]},$$

then, the structure of the homogenized problem is still provided by Theorem 3.14. In that case, the coefficients \mathcal{A}_i and \mathcal{B}_1^* are given by the product of the corresponding coefficients of TABLE 1 (unlike the link between the micro- macro- saturations, which is *not* provided by the product of the corresponding functions). More precisely, we have the following coefficients:

	$h := h_{[11]} h_{[22]}$	$h := h_{[12]} h_{[21]}$
\mathcal{A}_1	$\left(\overline{\left(\overline{h_{[11]}^{-3} Z} \right)^Y} \right)^{-1} \overline{\left(\overline{h_{[22]}^3 Z} \right)^Y}$	$\left(\overline{\left(\overline{h_{[12]}^3 Z} \right)^{-1Y}} \right)^{-1} \overline{\left(\overline{h_{[21]}^{-3} Z} \right)^{-1Y}}$
\mathcal{A}_2	$\overline{\left(\overline{h_{[11]}^3 Z} \right)^Y} \left(\overline{\left(\overline{h_{[22]}^{-3} Z} \right)^Y} \right)^{-1}$	$\overline{\left(\overline{h_{[12]}^{-3} Z} \right)^{-1Y}} \left(\overline{\left(\overline{h_{[21]}^3 Z} \right)^{-1Y}} \right)^{-1}$
\mathcal{B}_1^*	$\frac{\overline{\left(\overline{h_{[11]}^{-2} Z} \right)^{-2Y}}}{\overline{\left(\overline{h_{[11]}^{-3} Z} \right)^{-3Y}} \overline{\left(\overline{h_{[22]} Z} \right)^Y}}$	$\frac{\overline{\left(\overline{h_{[12]} Z} \right)^{-2Y}} \overline{\left(\overline{h_{[21]}^{-2} Z} \right)^Y}}{\overline{\left(\overline{h_{[12]} Z} \right)^{-3Y}} \overline{\left(\overline{h_{[21]}^{-3} Z} \right)^Y}}$

TABLE 2. Homogenized coefficients (Part 2)

Notice that existence and uniqueness of the solution still holds for the corresponding homogenized problem. The link between the micro- saturation θ_0 and the macro- (homogenized) saturation Θ may be determined as well; still, it is even more complicated than in TABLE 1 and, therefore, is voluntarily omitted.

4. A NUMERICAL SIMULATION

In this section, the numerical simulation of a hydrodynamic contact is performed to illustrate the theoretical results of convergence stated in the previous section. For this, we use the Bermudez-Moreno algorithm coupled to a characteristics method, the combination of these numerical techniques being proved to be rigorous and efficient (see [9,13]). In particular, the basic principles of the algorithm (and related proofs of convergence) may be found in [9] for the lubrication problem.

We address the numerical simulation of dimensionless journal bearing contacts so that, for a domain $\Omega =]0, 1[\times]0, 1[$, problem $(\mathcal{P}_\theta^\varepsilon)$ is considered. The datum h_ε is given by:

$$h_\varepsilon(x) = 1 + \rho \cos(2\pi x_1) + 0.35(1 - \rho) \sin\left(2\pi \frac{x_1}{\varepsilon^2}\right) + 0.35(1 - \rho) \sin\left(2\pi \frac{x_2}{\varepsilon}\right),$$

where ρ denotes the average eccentricity of the device. Additionally, the input flow Q has been taken to

$$Q = \theta_\star (1 + \rho),$$

where θ_\star denotes the saturation at the supply groove. In the numerical tests, the following values have been considered:

$$\rho = 0.5 \quad \text{and} \quad \theta_\star = 0.375.$$

Notice that the corresponding gap h only depends on the variables x , y_2 and z_1 . As a consequence, it can be identified to some function $h_{[12]}$ (see Definition 3.13), which falls into the scope of Theorem 3.14. Corresponding homogenized coefficients are provided by TABLE1 and may be easily computed.

Although numerical tests have been performed for different spatial meshes in order to control the convergence of the method, we just present the results corresponding to a mesh size 900×100 . Computations have been made for different values of ε (namely $1/4$, $1/6$, $1/8$) and for the corresponding homogenized case. The computer results illustrate the convergences stated in previous sections:

- FIG.2–4 present the pressure (left) and saturation (right) distribution in different cases:
 - ▷ FIG.2: $\varepsilon = 1/4$,
 - ▷ FIG.3: $\varepsilon = 1/6$,
 - ▷ FIG.4: homogenized case.

In particular, oscillatory effects induced by the roughness patterns may be easily observed.

- As the introduction of the oscillating gap h_ε leads to oscillatory effects in both transverse and longitudinal directions, we study some particular curves at different sections in order to observe the oscillations:
 - ▷ FIG.5 and 6 (resp. FIG.7 and 8) correspond to pressure (saturation) plots at $x_2^0 = 0.5$ (mid-section containing the homogenized peak pressure, for geometrical reasons). We show the convergence of the pressure to the homogenized (smooth) one, as ε tends to 0. Unlike the behavior of the pressure, the behavior of the saturation is more complicated: oscillations are not damped, thus illustrating the weak convergence of the saturation. However, this does not prevent us from defining an equivalent homogenized saturation.
 - ▷ FIG.9 and 10 correspond to pressure plots at $x_1^0 = 0.4118$ (section containing the homogenized peak pressure). The convergence of the pressure to the homogenized (smooth) one is also illustrated. Corresponding saturation curves are omitted (since no cavitation appears in this section).
- FIG.11 and 12 correspond to the homogenized solution (pressure and saturation) in the whole domain.

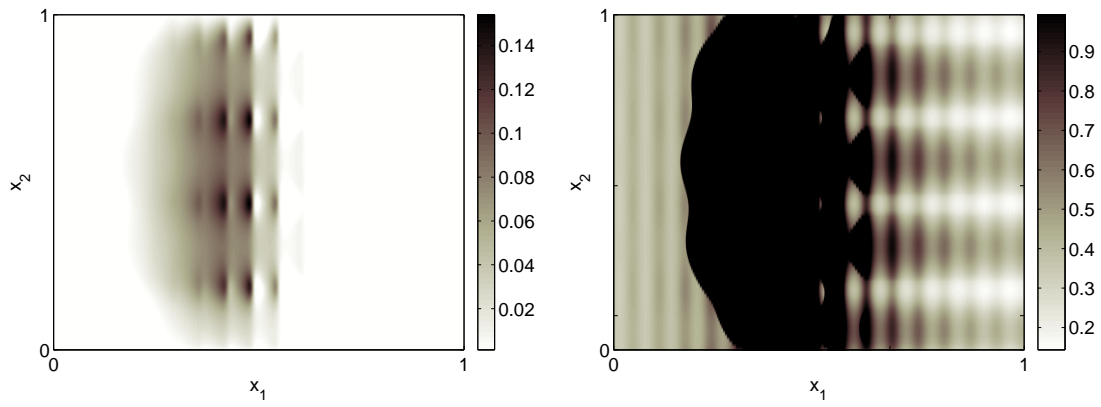

FIGURE 2. Pressure (l) and saturation (r) in the whole domain for $\varepsilon = 1/4$

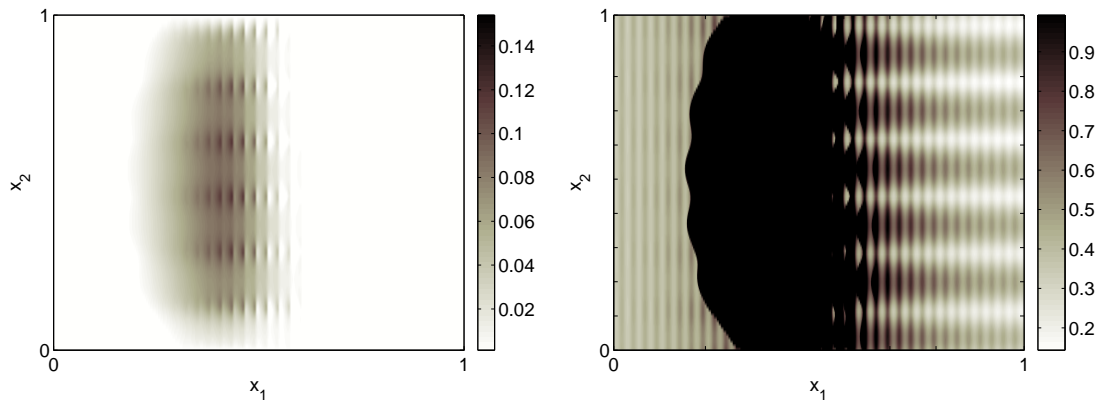

FIGURE 3. Pressure (l) and saturation (r) in the whole domain for $\varepsilon = 1/6$

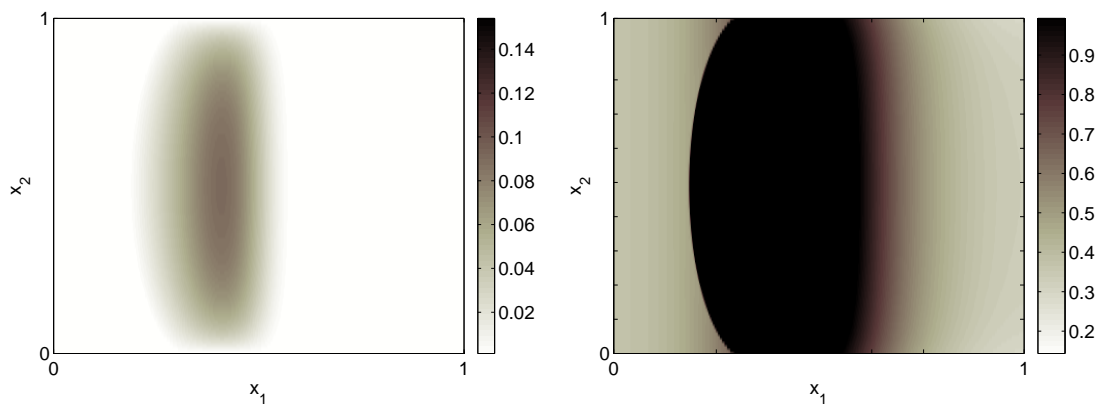
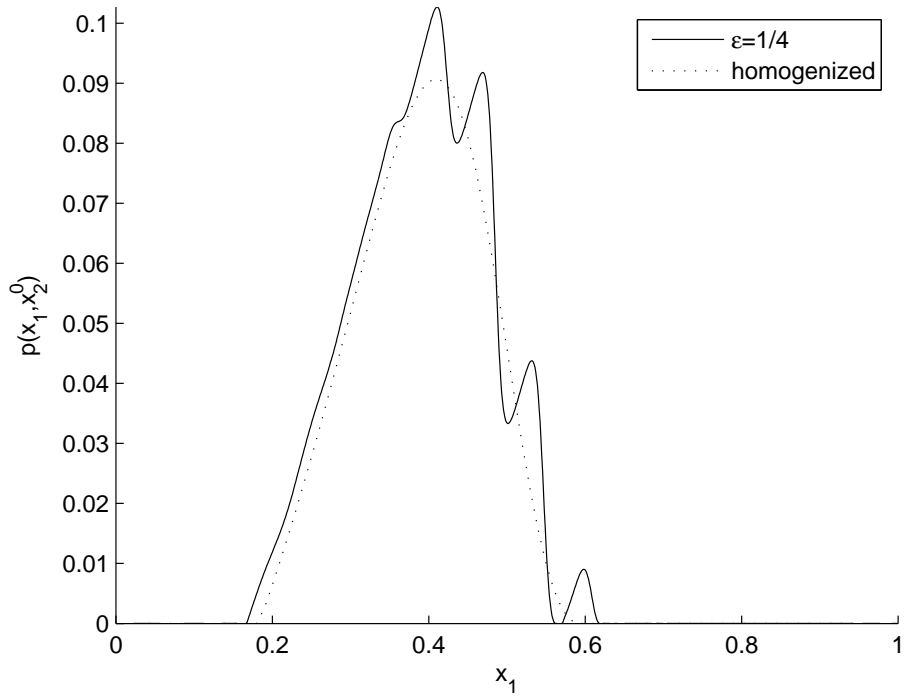
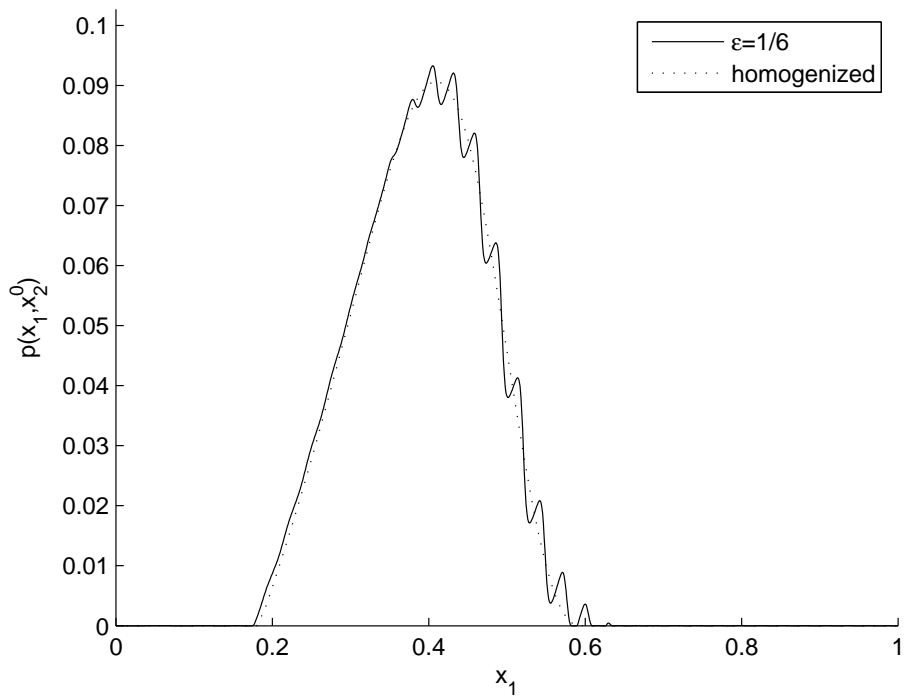

FIGURE 4. Homogenized pressure (l) and saturation (r) in the whole domain

FIGURE 5. Pressure distribution at fixed $x_2^0 = 0.5$ FIGURE 6. Pressure distribution at fixed $x_2^0 = 0.5$

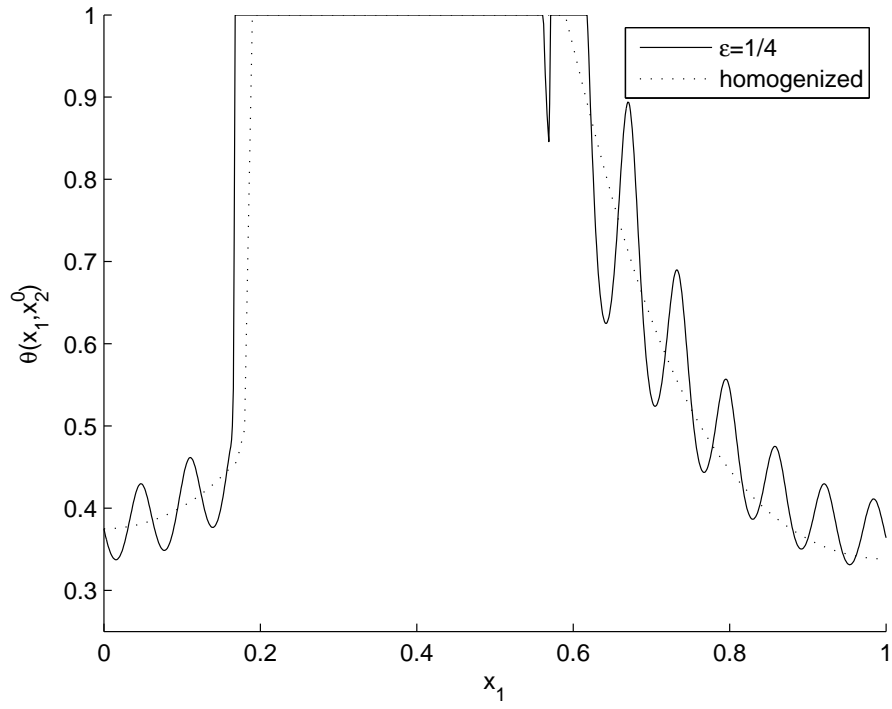

FIGURE 7. Pressure distribution at fixed $x_2^0 = 0.5$

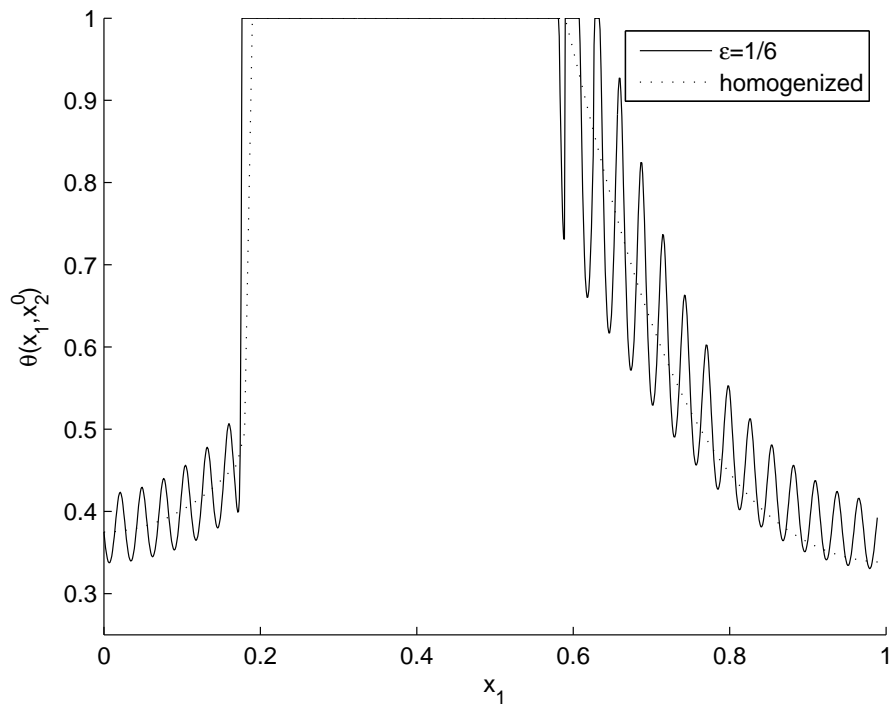

FIGURE 8. Saturation distribution at fixed $x_2^0 = 0.5$

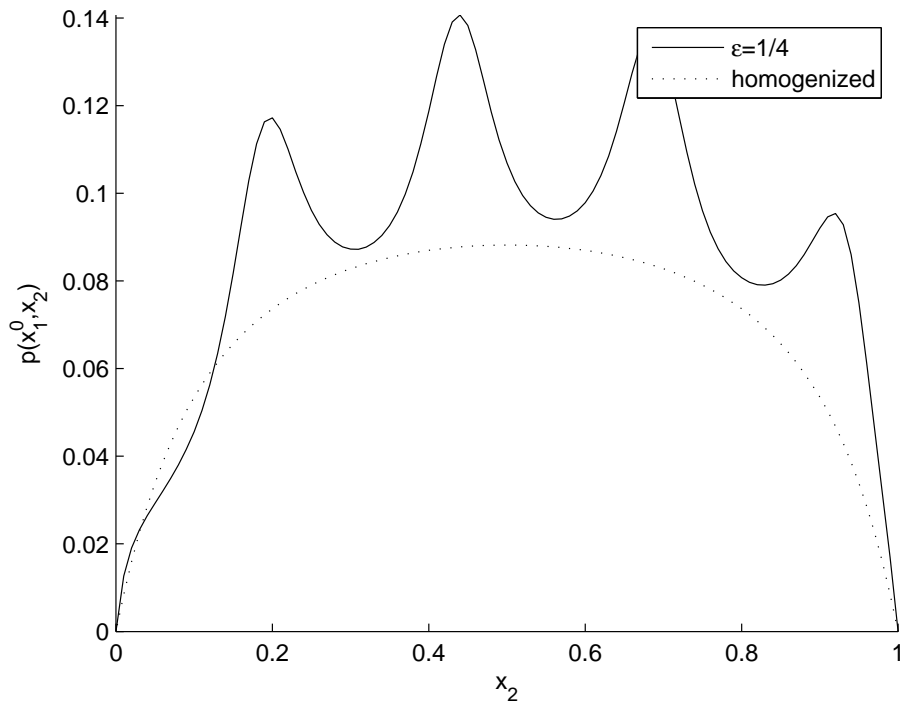

FIGURE 9. Saturation distribution at fixed $x_1^0 = 0.4118$

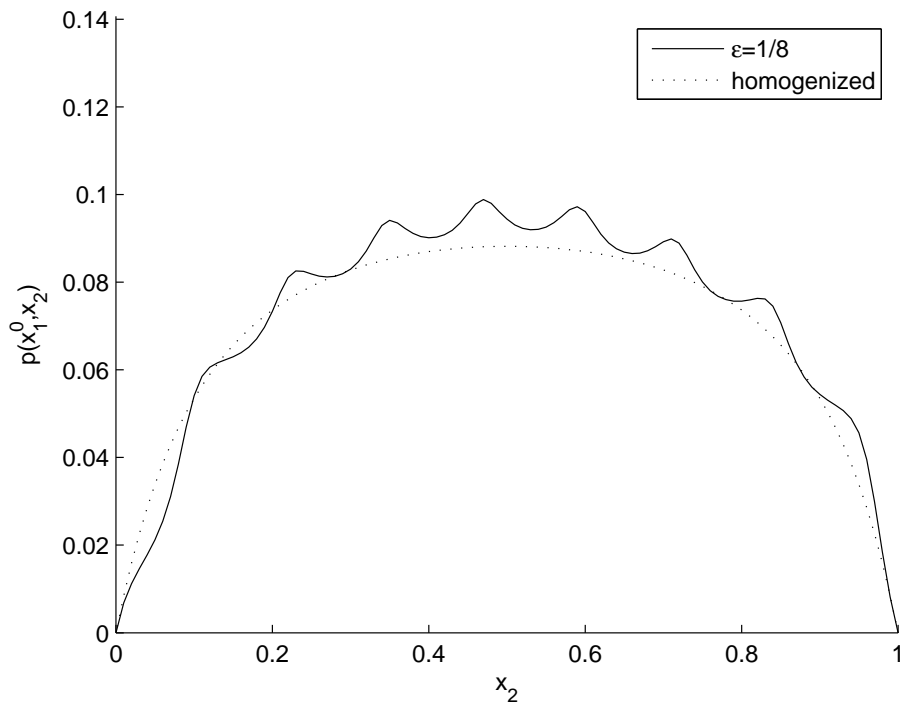

FIGURE 10. Saturation distribution at fixed $x_1^0 = 0.4118$

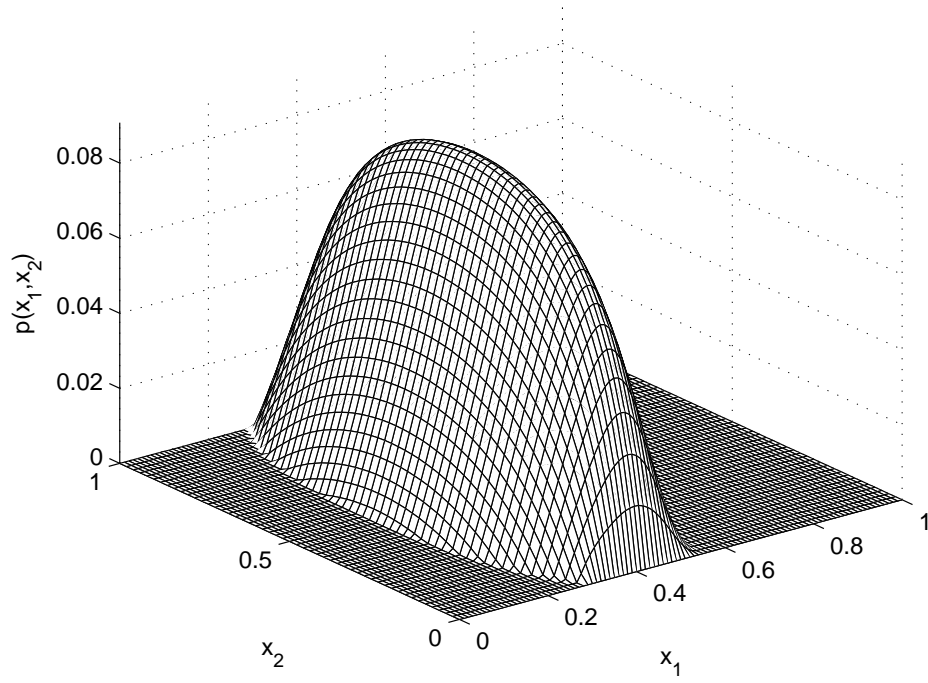

FIGURE 11. Homogenized pressure distribution in the whole domain

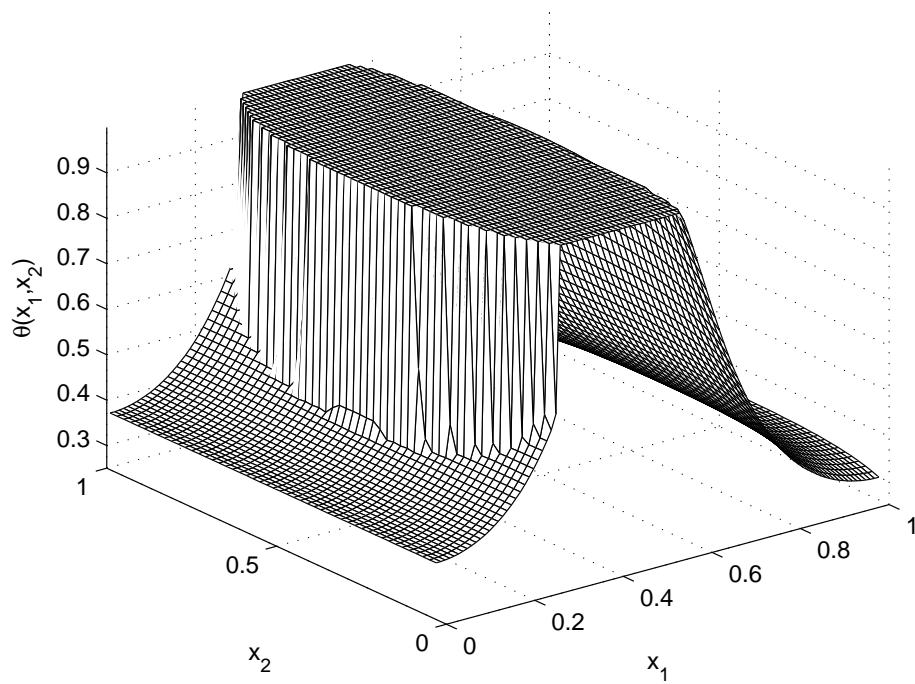

FIGURE 12. Homogenized saturation distribution in the whole domain

CONCLUSION

The asymptotic analysis which has been presented here, in the hydrodynamic framework, generalizes some results presented in [12]. In the same way, it can be rigorously extended to the reiterated homogenization of elastohydrodynamic problems in lubrication theory. Actually, elastohydrodynamic lubrication (EHL) occurs between point or line contact, so all the loading is concentrated over a small contact area. Typical applications are rolling element bearings, most gears, and cams and tappets [18]. The concentrated contact results in high peak pressures of 1-2 GPa between the surfaces. This is too high to be supported by a normal hydrodynamic film, and application of simple hydrodynamic theory predicts negligible oil film thickness. Firstly, elastic flattening of the contacting surfaces occurs. Secondly, the high pressure greatly increases the viscosity of the lubricant in the contact. Elastohydrodynamic lubrication is consequently analyzed using a combination of Reynolds equation, elasticity theory (the Hertz equation) and a lubricant viscosity-pressure equation. The set of equations to be considered is the following one:

$$\operatorname{div}\left(h[p]^3 e^{-\alpha p} \nabla p\right) = \frac{\partial}{\partial x_1}(\theta h[p]), \quad (17)$$

$$p \geq 0, \quad \theta \in H(p), \quad (18)$$

in which three nonlinearities appear and need to be explained further:

- *cavitation phenomena*, which are taken into account by using the Elrod-Adams model;
- *elastic deformation of the surfaces*, which is taken into account as follows: the effective gap, $h[p]$, contains a rigid contribution h_r and an elastic one

$$h[p] = h_r + \int_{\Omega} k(\cdot, z) p(z) dz, \quad \text{with } k(x, z) = \begin{cases} \log\left(\frac{2l_1 - z_1}{x_1 - z_1}\right), & \text{for line contacts,} \\ \frac{1}{\sqrt{(x_1 - z_1)^2 + (x_2 - z_2)^2}}, & \text{for point contacts,} \end{cases}$$

which leads to a nonlocal problem;

- *piezoviscosity of the fluid*, which is modelled by the Barus law: this modifies the left-hand side of the generalized Reynolds equation through the introduction of the term $e^{-\alpha p}$, $\alpha > 0$ denoting the piezoviscosity parameter.

As in the hydrodynamic case, a rigorous asymptotic analysis with complete and explicit computations can be led when h_r is highly oscillating with roughness scales of order ε and ε^2 , thus generalizing the results presented in [11].

REFERENCES

- [1] G. ALLAIRE, *Homogenization and two-scale convergence*, SIAM J. Math. Anal., 23 (1992), pp. 1482–1518.
- [2] H. W. ALT, *Strömungen durch inhomogene poröse Medien mit freiem Rand*, J. Reine Angew. Math., 305 (1979), pp. 89–115.
- [3] ———, *Numerical solution of steady-state porous flow free boundary problems*, Numer. Math., 36 (1980/81), pp. 73–98.
- [4] S. J. ALVAREZ AND J. CARRILLO, *A free boundary problem in theory of lubrication*, Comm. Partial Differential Equations, 19 (1994), pp. 1743–1761.
- [5] S. J. ALVAREZ AND R. OUJJA, *On the uniqueness of the solution of an evolution free boundary problem in theory of lubrication*, Nonlinear Anal., 54 (2003), pp. 845–872.
- [6] G. BAYADA AND M. CHAMBAT, *Analysis of a free boundary problem in partial lubrication*, Quart. Appl. Math., 40 (1982/83), pp. 369–375.
- [7] ———, *Existence and uniqueness for a lubrication problem with nonregular conditions on the free boundary*, Boll. Un. Mat. Ital. B (6), 3 (1984), pp. 543–557.
- [8] ———, *The transition between the Stokes equations and the Reynolds equation: a mathematical proof*, Appl. Math. Optim., 14 (1986), pp. 73–93.
- [9] G. BAYADA, M. CHAMBAT, AND C. VÁZQUEZ, *Characteristics method for the formulation and computation of a free boundary cavitation problem*, J. Comput. Appl. Math., 98 (1998), pp. 191–212.

- [10] G. BAYADA AND J.-B. FAURE, *A double-scale analysis approach of the Reynolds roughness. Comments and application to the journal bearing*, ASME J. Tribol., 111 (1989), pp. 323–330.
- [11] G. BAYADA, S. MARTIN, AND C. VÁZQUEZ, *Homogenization of a nonlocal elastohydrodynamic lubrication problem: a new free boundary model*, Math. Mod. Meth. Appl. Sci., 15 (2005), pp. 1923–1956.
- [12] ———, *Two-scale homogenization of a hydrodynamic Elrod-Adams model*, Asymptot. Anal., 44 (2005), pp. 75–110.
- [13] A. BERMÚDEZ AND J. DURANY, *La méthode des caractéristiques pour les problèmes de convection-diffusion stationnaires*, RAIRO Modél. Math. Anal. Numér., 21 (1987), pp. 7–26.
- [14] G. CAPRIZ AND G. CIMATTI, *Partial lubrication of full cylindrical bearings*, ASME J. Lubrication Technol., 105 (1983), pp. 84–89.
- [15] D. CIORANESCU, A. DAMLAMIAN, AND G. GRISO, *Periodic unfolding and homogenization*, C. R. Math. Acad. Sci. Paris, 335 (2002), pp. 99–104.
- [16] J. COYNE AND H. G. ELROD, *Conditions for the rupture of a lubricating film, Part 1*, ASME J. Lubrication Technol., 92 (1970), pp. 451–456.
- [17] ———, *Conditions for the rupture of a lubricating film, Part 2*, ASME J. Lubrication Technol., 93 (1971), pp. 156–167.
- [18] D. DOWSON AND G. R. HIGGINSON, *Elastohydrodynamic lubrication*, Pergamon Press, Oxford, Great Britain, 1977.
- [19] H. G. ELROD AND M. L. ADAMS, *A computer program for cavitation*, Cavitation and related phenomena in lubrication - Proceedings - Mech. Eng. Publ. Ltd, (1975), pp. 37–42.
- [20] M. JAI, *Homogenization and two-scale convergence of the compressible Reynolds lubrication equation modelling the flying characteristics of a rough magnetic head over a rough rigid-disk surface*, RAIRO Modél. Math. Anal. Numér., 29 (1995), pp. 199–233.
- [21] S. N. KRŪŽKOV, *First order quasilinear equations with several independent variables*, Mat. Sb. (N.S.), 81 (123) (1970), pp. 228–255.
- [22] D. LUKKASSEN, G. NGUETSENG, AND P. WALL, *Two-scale convergence*, Int. J. Pure Appl. Math., 2 (2002), pp. 35–86.
- [23] L. D. MARINI AND P. PIETRA, *Fixed-point algorithms for stationary flow in porous media*, Comput. Methods Appl. Mech. Engrg., 56 (1986), pp. 17–45.
- [24] S. MARTIN, *Contribution à la modélisation de phénomènes de frontière libre en mécanique des films minces*, Thèse de doctorat de l'Institut National des Sciences Appliquées de Lyon, (2005).
- [25] G. NGUETSENG, *A general convergence result for a functional related to the theory of homogenization*, SIAM J. Math. Anal., 20 (1989), pp. 608–623.
- [26] N. PATIR AND H. S. CHENG, *An average flow model for determining effects of three-dimensional roughness on partial hydrodynamic lubrication*, ASME J. Lubrication Technol., 100 (1978), pp. 12–17.
- [27] O. REYNOLDS, *On the theory of lubrication and its application to Mr Beauchamp tower's experiments, including an experimental determination of the viscosity of olive oil*, Phil. Trans. Roy. Soc., A 117 (1886), pp. 157–234.
- [28] J.-F. RODRIGUES, *Some remarks on the homogenization of the dam problem*, Manuscripta Math., 46 (1984), pp. 65–82.
- [29] C. VÁZQUEZ, *Existence and uniqueness of solution for a lubrication problem with cavitation in a journal bearing with axial supply*, Adv. Math. Sci. Appl., 4 (1994), pp. 313–331.