



HAL
open science

On extremal permutations avoiding $\omega_N = N \ N-1 \ \dots \ 1$

Joël Yann Fourré, Daniel Krob, Jean-Christophe Novelli

► **To cite this version:**

Joël Yann Fourré, Daniel Krob, Jean-Christophe Novelli. On extremal permutations avoiding $\omega_N = N \ N-1 \ \dots \ 1$. European Journal of Combinatorics, 1999, 20, pp.773-787. hal-00018543

HAL Id: hal-00018543

<https://hal.science/hal-00018543>

Submitted on 4 Feb 2006

HAL is a multi-disciplinary open access archive for the deposit and dissemination of scientific research documents, whether they are published or not. The documents may come from teaching and research institutions in France or abroad, or from public or private research centers.

L'archive ouverte pluridisciplinaire **HAL**, est destinée au dépôt et à la diffusion de documents scientifiques de niveau recherche, publiés ou non, émanant des établissements d'enseignement et de recherche français ou étrangers, des laboratoires publics ou privés.

On extremal permutations avoiding $\omega_N = N N-1 \dots 1$

J.-Y. Fourré*, D. Krob*, J.-C. Novelli*

Dedicated to the memory of Marcel–Paul Schützenberger

Résumé

Cet article présente une étude des permutations qui évitent le motif de la permutation maximale $\omega_N = N N-1 \dots 1$. Après avoir donné les définitions classiques, nous montrons que l'ensemble de ces permutations est un idéal pour l'ordre de Bruhat faible et faisons alors l'étude de ses éléments maximaux. Nous exhibons alors un algorithme pour calculer ces éléments et nous montrons que ceux-ci peuvent être obtenus à partir d'un automate. Nous terminons en donnant des estimations asymptotiques de leur nombre.

Abstract

This paper presents a study of permutations avoiding the pattern $\omega_N = N N-1 \dots 1$. After having recalled the basic definitions, we prove that this set of permutations is an ideal for the weak Bruhat order and begin the study of its maximal elements. We then present an algorithm that generates these elements and find out that they can be obtained from an automaton. We finally give some asymptotics about their number.

1 Introduction

An important literature is devoted to the study of permutations that avoid a given pattern or a given family of patterns (see for instance [1, 2, 3, 4, 11, 19]). They are indeed involved in several kinds of contexts such as pattern matching (see [5]), sorting problems (see [13, 20, 8]) or Schubert polynomials (see [16]). However, even if a lot of work was carried out on the study of these permutations, several interesting problems still remain open or unexplored. Many efforts have in particular been made to enumerate the permutations with the forbidden subsequence $\omega_N = N N-1 \dots 1$ which are related to pairs of standard Young tableaux having the same shape and height at most $N - 1$.

First, Regev (see [17]) obtained using non trivial methods an asymptotic estimate of the number of such permutations. Gessel (see [9]) obtained the exact formula in terms of Bessel functions some years ago and, more recently, published (see [10]) two bijective proofs of this result.

The initial motivation of this paper came from the fact that the permutations that avoid ω_N also appear in the context of quantum groups of type A . Let indeed V be a given \mathbb{C} -vector space of dimension N . There is then a variant of Jimbo's right action (see [12]) of the Hecke algebra

* LIAFA – Université Paris 7 – 2, place Jussieu – 75251 Paris Cedex 05 – France; *e-mails* : jyf@liafa.jussieu.fr (J.-Y. Fourré), dk@liafa.jussieu.fr (D. Krob), novelli@liafa.jussieu.fr (J.-C. Novelli). Corresponding author: J.-C. Novelli.

$H_n(q)$ on $V^{\otimes n}$ that was introduced in [6, 7] and used as a main tool in [14]. One can then show (see [15]) that the dimension of the image under this action of the Hecke algebra $H_n(q)$ in $\text{End}_{\mathbb{C}}(V^{\otimes n})$ is exactly equal to the number of permutations that avoid the pattern ω_{N+1} .

This paper can therefore be seen as an attempt to use some new ideas coming directly from this last algebraic context for studying permutations that avoid ω_N . It appears in particular that nobody took really into account the fact that this set of permutations was an ideal for the weak Bruhat order. Since an ideal is characterized by its extremal elements, we focused this paper on the study of these extremal permutations. We propose here in particular an algorithm for generating these permutations which relies on combinatorial properties of ribbons. Using this algorithm, we show that our extremal permutations can be encoded into a rational language whose minimal automaton has a nice hypercubic structure. The use of this automaton allows then us to give enumerative formulas for the extremal permutations that avoid ω_N .

Acknowledgements

The authors are very grateful to Mireille Bousquet-Mélou for all her helpful comments about this work.

2 Preliminaries

2.1 Permutations avoiding a pattern

We are interested in this paper in studying the set formed by all permutations of a given order n that avoid the pattern $\omega_N = NN-1 \dots 1$. Let us however first replace this problem in its general context.

Definition 2.1 *A permutation σ of \mathfrak{S}_n avoids the pattern π of \mathfrak{S}_k if and only if there is no subsequence $i_{\pi(1)} < i_{\pi(2)} < \dots < i_{\pi(k)}$ in $[1, n]$ such that $\sigma(i_1) < \sigma(i_2) < \dots < \sigma(i_k)$.*

It follows from Definition 2.1 that a permutation σ of \mathfrak{S}_n avoids ω_N iff there is no strictly increasing subsequence $i_1 < i_2 < \dots < i_N$ in $[1, n]$ such that $\sigma(i_1) > \sigma(i_2) > \dots > \sigma(i_N)$. In the sequel of this paper, we shall denote by $\Omega_{n,N}$ the set of permutations of \mathfrak{S}_n that avoid the pattern ω_N . Note that $\Omega_{n,N}$ is equal to \mathfrak{S}_n when $N - 1 \geq n$.

2.2 Compositions and ribbons

A composition of n is a sequence $I = (i_1, \dots, i_r)$ of strictly positive integers whose sum is equal to n . The length $\ell(I)$ of the composition I is then just the number r of integers involved in such a sequence. One represents usually a composition I by a ribbon diagram of shape I , *i.e.*, by a skew Ferrers diagram of ribbon shape I . The ribbon diagram associated with the composition $I = (3, 2, 1, 4)$ is for instance given below.

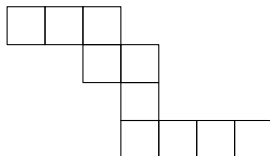

Let us now recall that the *descent set* of a permutation σ of \mathfrak{S}_n is the subset of $[1, n-1]$ denoted by $\mathcal{D}(\sigma)$ of all integers $i \in [1, n-1]$ such that $\sigma(i) > \sigma(i+1)$. One also associates with every composition $I = (i_1, \dots, i_r)$ of n the subset $D(I)$ of $[1, n-1]$ defined by $D(I) = \{i_1, i_1 + i_2, \dots, i_1 + \dots + i_{r-1}\}$. The *ribbon shape* of a permutation σ is then the unique composition $C(\sigma)$ of n such that $D(C(\sigma)) = \mathcal{D}(\sigma)$. The *ribbon diagram* associated with σ is then the filling from top to bottom and from left to right of the rows of $C(\sigma)$ reading σ as a word. We show below the ribbon diagram associated with the permutation 245316. Notice that $C(245316) = (3, 1, 2)$.

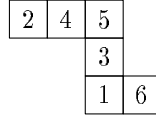

2.3 The weak Bruhat order

An *elementary transposition* is a permutation that exchanges two adjacent numbers i and $i+1$ and let the others unchanged. This permutation is denoted σ_i . A *reduced decomposition* of a permutation is a decomposition of this permutation as a minimal product of elementary transpositions. In the sequel, we use the same partial ordering on permutations, the *weak Bruhat order*: a permutation σ is said to be smaller than a permutation τ if and only if there exists two reduced decompositions of σ and τ such that the decomposition of σ is a factor of the decomposition of τ . We will then write $\sigma \leq \tau$. The product over the permutations is the classical one, so that if $\sigma = \sigma(1) \dots \sigma(n)$ and τ denotes $\sigma \dot{\sigma}_i$ we have

$$\tau = \sigma(1) \dots \sigma(i+1)\sigma(i) \dots \sigma(n)$$

3 The ideal of permutations avoiding ω_N

3.1 The ideal $\Omega_{n,N}$

In the sequel, we denote by $d_{n,N}$ the cardinality of $\Omega_{n,N}$, *i.e.*, the number of permutations of \mathfrak{S}_n avoiding ω_N . We first establish a simple property about $\Omega_{n,N}$.

Proposition 3.1 *The set $\Omega_{n,N}$ is a lower ideal of \mathfrak{S}_n for the weak Bruhat order.*

Proof – It suffices to observe that a permutation σ of \mathfrak{S}_n belongs to $\Omega_{n,N}$ if and only if σ does not have a reduced decomposition of the form

$$\sigma = \sigma_{i_1} \dots \sigma_{i_r} \omega \sigma_{i_{r+1}} \dots \sigma_{i_s}$$

where ω stands for an arbitrary reduced decomposition of ω_N . The proposition follows then immediately from this characterization of the elements of $\Omega_{n,N}$. ■

Notation 3.2 *We will denote by $E_{n,N}$ the set of the extremal elements of $\Omega_{n,N}$ for the weak Bruhat order.*

We now give a sort of converse of the previous proposition.

Proposition 3.3 *Let p be a permutation of length N different from ω_N . Then the set S of all permutations of \mathfrak{S}_n with $n \geq N$ avoiding the pattern p is not a lower ideal of \mathfrak{S}_n .*

Proof – First, notice that the permutation ω_n avoids the pattern p . Since ω_n is the greatest permutation for the weak Bruhat order, it is in particular greater than the permutation obtained by concatenating $(N+1) \dots n$ to p that does not avoid the pattern p . So S is not a lower ideal. ■

Note 3.4 Notice that when $n \leq N-1$, the maximal permutation is in $E_{n,N}$ so that $E_{n,N} = \{\omega_n\}$.

The next proposition establishes the first property about the set $E_{n,N}$ and allows us to derive a description of $\Omega_{n,N}$ in terms of the weak Bruhat order.

Proposition 3.5 *Let n and N be two non-zero integers such that $n \geq N$. Let σ be an element of \mathfrak{S}_n and let $r(\sigma)$ denote its associated ribbon diagram. The two following assertions are equivalent:*

1. σ is an element of $E_{n,N}$,
2. The two subsequences of σ formed respectively by the first and the last element of each row of $r(\sigma)$ are decreasing and the height of $r(\sigma)$ is $N-1$.

Proof – We are going to prove this result by double implication.

Let σ be an element of $E_{n,N}$. We first prove that the subsequence of σ formed by the first element of each row of $r(\sigma)$ is decreasing. Since we will use further this result, it is written as a lemma.

Lemma 3.6 *Let σ be an element of $E_{n,N}$ and let $r(\sigma)$ be its associated ribbon diagram. The subsequence of σ formed by the first element of each row of $r(\sigma)$ is decreasing.*

Proof of the lemma — Let us indeed assume that it is not the case. There exists then two integers $a < d$ such that one has the following situation in $r(\sigma)$.

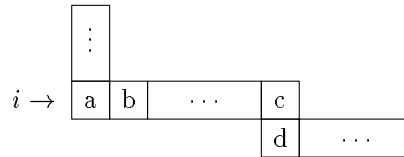

Hence, one has $a < d < c$. There exist therefore two consecutive elements $x < y$ of row i such that $x < d < y$. By extremality of σ , the permutation obtained from σ by exchanging x and y has a decreasing subsequence $(a_i)_{1 \leq i \leq N}$ of length N . This subsequence must clearly contain both x and y . Hence there exists an integer $i \in [1, N-1]$ such that $a_i = y$ and $a_{i+1} = x$. Note that one has $a_{i+2} < x < d$. Hence the subsequence

$$a_1 > \dots > a_{i-1} > y > d > a_{i+2} > \dots > a_N$$

is then also clearly decreasing, but can be extracted from σ which is not possible since σ belongs to $\Omega_{n,N}$. This contradiction proves the lemma. ■

One can prove in the same way that the subsequence formed by the last element of each row of $r(\sigma)$ is decreasing. To prove the first implication of Proposition 3.5, it remains to show that the height of $r(\sigma)$ is $N-1$.

Thanks to Lemma 3.6 and since σ belongs to $\Omega_{n,N}$, $r(\sigma)$ is at most $N-1$. Let us show that $r(\sigma)$ is at least $N-1$. Since $n \geq N$, σ is different from ω_n that does not belong to $\Omega_{n,N}$. Hence there exists an integer $i \in [1, n-1]$ such that $\sigma(i) < \sigma(i+1)$. As σ is extremal, the permutation

$$\sigma \sigma_i = \sigma(1) \dots \sigma(i-1) \sigma(i+1) \sigma(i) \sigma(i+2) \dots \sigma(n)$$

does not belong to $\Omega_{n,N}$ and hence must contain a decreasing subsequence of length greater than or equal to N . Thus σ must contain a decreasing subsequence of length greater than or equal to $N-1$.

Since σ belongs to $\Omega_{n,N}$, we deduce that σ contains a decreasing subsequence of length $N-1$ and hence that the height of $r(\sigma)$ is at least $N-1$.

Conversely, let σ be a permutation satisfying the conditions of Assertion 2. Since the height of $r(\sigma)$ is $N-1$, σ has no decreasing sequence of length N , so that σ belongs to $\Omega_{n,N}$.

Let us now show that σ is an extremal element of $\Omega_{n,N}$. For this purpose, let us consider a permutation τ which is an immediate successor of σ in the weak Bruhat order. Such a permutation is obtained by permuting two consecutive elements $x < y$ belonging to the same row of $r(\sigma)$ (say row k). Let us denote by $(a_i)_{1 \leq i \leq N-1}$ (resp. $(b_i)_{1 \leq i \leq N-1}$) the sequence of the first (resp. last) element of each row. The sequence $a_i \dots a_{k-1}, y, x, b_{k+1} \dots b_{N-1}$ is then a decreasing subsequence of τ of length N . Hence τ does not belong to $\Omega_{n,N}$. So, σ is an element of $E_{n,N}$. ■

4 Generation of the elements of $E_{n,N}$

From now on, we will always assume that $n \geq N-1$. The purpose of this subsection is to present an algorithm generating all the elements of $E_{n,N}$. The first algorithm takes as input a permutation $\sigma \in \mathfrak{S}_n$ with $N-2$ descents and returns as the output a permutation $\tau \in \mathfrak{S}_{n+1}$ with $N-2$ descents too.

Algorithm 4.1

INPUT: A permutation σ with $N-2$ descents and an integer $k \in [1, N-1]$.

OUTPUT: A permutation τ .

1. Set the ribbon diagram $r(\sigma)$ associated with σ and compute its shape (i_1, \dots, i_{N-1}) .
2. Form the composition $J := (i_1, \dots, i_{k-1}, i_k + 1, i_{k+1}, \dots, i_{N-1})$.
3. Fill the ribbon diagram r_J of ribbon shape J according to the following rules:
 - Rule 1: If n denotes the length of σ , put $n+1$ at the end of the first row of r_J .
 - Rule 2: Move each last element of the first $k-1$ rows to the end of the row just below it;
 - Rule 3: Fill the beginning of each row of r_J with the elements of the corresponding row of $r(\sigma)$;
4. Form the permutation τ by reading from left to right and from top to bottom the rows of r_J .

The next algorithm sends a set $E_{n,N}$ on a new set of permutations. Theorem 4.6, to follow, will establish that this set actually is $E_{n+1,N}$.

Algorithm 4.2

INPUT: A set $E_{n,N}$, with $n \geq N - 1$.
 OUTPUT: A set $S_{n+1,N}$ of permutations.

1. Set $S_{n+1,N} = \emptyset$.
2. For every $\sigma \in E_{n,N}$, for every $k \in [1, N - 1]$,
 - (a) Compute the permutation τ obtained by applying Algorithm 4.1 to (σ, k) ;
 - (b) If the sequence formed by the first element of each row of the ribbon diagram associated with τ is decreasing, add τ to $S_{n+1,N}$.

Note 4.3 Algorithm 4.2 can be interpreted as the construction of a graph where there is an edge labeled k from σ to τ if τ is output from Algorithm 4.1 applied to (σ, k) . We will see when studying the converse algorithm that this graph is in fact a tree.

Note 4.4 One can use the previous result to design a parallel algorithm generating all permutations of $\Omega_{n,N}$.

Example 4.5 In Figure 1, we give a part of the two first levels of the graph built by the previous algorithm when $N = 5$. The deleted permutations correspond to the permutations such that the first elements of each row of their ribbon diagram do not form a decreasing sequence.

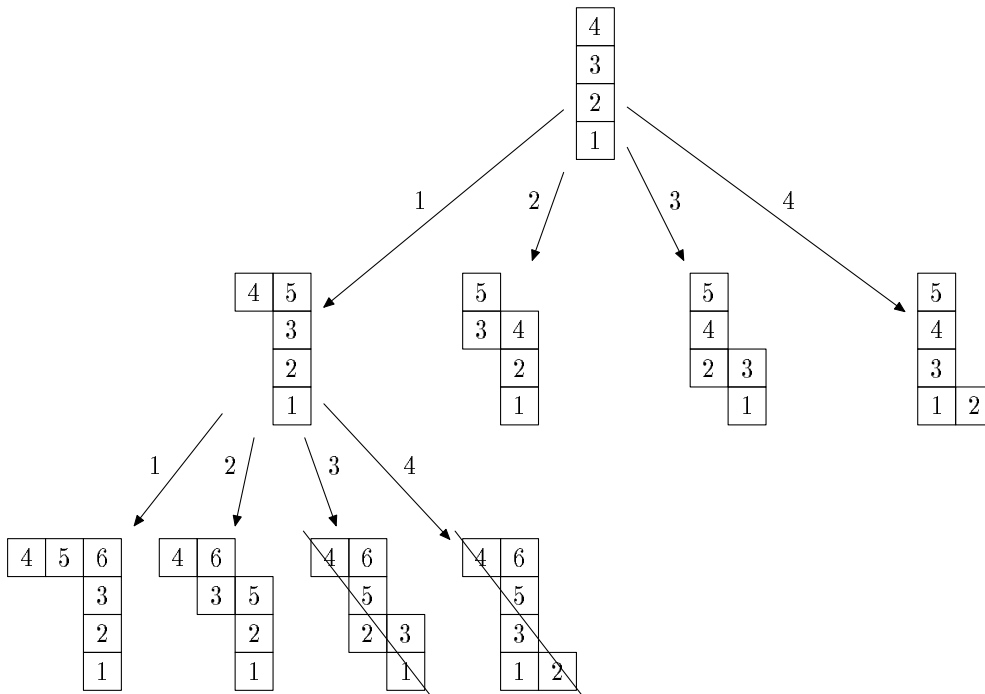

Figure 1: The beginning of the graph generated by Algorithm 4.2.

We can now give the following important result.

Theorem 4.6 Algorithm 4.2 sends $E_{n,N}$ to $E_{n+1,N}$.

Proof – By construction, all the elements of $S_{n+1,N}$ satisfy the conditions of Proposition 3.5. Thus, $S_{n+1,N}$ is a subset of $E_{n+1,N}$. Conversely, we only need to show that every element of $E_{n+1,N}$ can be obtained by Algorithm 4.1 from an element of $E_{n,N}$, and an integer $k \in [1, N-1]$.

The next algorithm sends an element σ of $E_{n,N}$ on a permutation and an integer. We will prove further that applying Algorithm 4.1 to this permutation and this integer, one obtains σ .

Algorithm 4.7

INPUT: An element σ of $E_{n,N}$, with $n \geq N$.

OUTPUT: A permutation τ and an integer $k \in [1, N-1]$.

1. Set the ribbon diagram $r(\sigma)$ associated with σ .
2. Let k be the smallest integer such that the k -th row of $r(\sigma)$ contains at least two elements, and such that the last-but-one element of the k -th row is greater than the last element of the $(k+1)$ -th row. If such an integer k does not exist, put $k = N-1$.

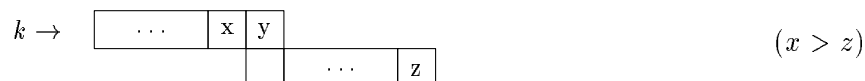

3. For every $i \in [2, k]$, replace the last element of the $(i-1)$ -th row of $r(\sigma)$ by the last one of the i -th row.
4. Delete the last cell of the k -th row of $r(\sigma)$.
5. Glue together in the unique possible way the two ribbon diagrams obtained after the previous step to obtain a ribbon diagram of height $N-1$.
6. The permutation τ is obtained by reading from top to bottom and from left to right the rows of the ribbon diagram obtained in Step 5 and the algorithm outputs (τ, k) .

Let us first prove that this algorithm is correct, *i.e.*, that the k -th row always contains at least two cells. As $n \geq N$, $r(\sigma)$ contains at least a row with at least two cells. As the sequence of the first letter of each row of the ribbon diagram $r(\sigma)$ is decreasing, if a row with more than one cell is followed by a row with exactly one cell, there will exist an integer k satisfying the condition of Step 2 of Algorithm 4.7. This implies in particular that the $(N-1)$ -th row of the diagram contains at least two cells when k is set to $N-1$.

It is easy to see that the ribbon diagram obtained by the previous algorithm defines an element of $E_{n-1,N}$: its height is equal to $N-1$ and the two sequences formed by the first and last elements of each row are clearly decreasing. Notice also that executing Steps 3 to 5 of Algorithm 4.7 with another value k' of k does not output an element of $E_{n-1,N}$: if $k' < k$, the sequence formed by the last elements of each row of the obtained ribbon is not decreasing; if $k' > k$, the permutation output has strictly more than $N-1$ descents. This shows that the pair built by the previous algorithm is the unique predecessor of σ in Algorithm 4.2. Hence the graph built by Algorithm 4.2 is in fact a tree. ■

5 Enumeration of $E_{n,N}$

In the previous section, we described an algorithm for generating the elements of $E_{n,N}$. In this section, we use this algorithm to enumerate them and obtain asymptotic equivalents. First, one

can see that there is a natural language on the alphabet $A_N = [1, N-1]$ associated with the infinite tree built by Algorithm 4.2. As there is a unique path in this tree going from the root to a given element σ of $E_{n,N}$, we associate with σ the word $w(\sigma)$ obtained by reading the successive labels of the edges of the path. For example, the permutations 456321 and 463521 (in $E_{6,5}$) are respectively encoded by the words (1, 1) and (1, 2) (see Figure 1).

Let us denote by L_N the language

$$L_N = \{w(\sigma), \sigma \in E_{n,N}, n \geq N-1\}.$$

In order to compute the generating series of its length distribution, we must look for the conditions on the integer k that allows us to obtain an element of $E_{n,N}$ when applying Algorithm 4.1 to (σ, k) . First, let us give some new definitions that will be useful in the sequel.

Definition 5.1 *Let σ be an element of $E_{n,N}$ and $r(\sigma)$ its associated ribbon diagram. We define $X(\sigma)$ as the subset of $[1, N-1]$ consisting in the indices of the rows of $r(\sigma)$ that have more than one cell. Let $a(\sigma)$ be the smallest element of $X(\sigma)$ and let $b(\sigma)$ be the largest integer such that $[a(\sigma), b(\sigma)] \subset X(\sigma)$. Finally, let $A(\sigma)$ be the interval $[1, b(\sigma) + 1] \cap [1, N-1]$.*

Let us give a complete example of the previous definition. Let σ be 968574231 ($N = 7$). Then $X(\sigma) = \{2, 3, 5\}$ and $A(\sigma) = [1, 4]$ as one can see in Figure 2.

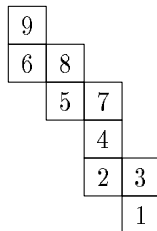

Figure 2: The ribbon diagram of 968574231.

We do not give the proof of the following lemma since it is very technical and we will not use it in the sequel.

Lemma 5.2 *Let σ be an element of $E_{n,N}$, let k be an integer and let τ denote the output of Algorithm 4.1 applied to (σ, τ) . The two following assertions are equivalent:*

1. τ belongs to $E_{n+1,N}$;
2. k belongs to $A(\sigma)$.

Let us now define an automaton related to the language L_N . The main idea for building this automaton comes from the previous lemma: indeed, assuming that a permutation σ belongs to $E_{n,N}$, it is sufficient to know $X(\sigma)$ to compute the set of all the integers k such that the output of Algorithm 4.1 applied to (σ, k) is an element τ of $E_{n+1,N}$. Notice in particular that if τ belongs to $E_{n+1,N}$, $X(\tau) = X(\sigma) \cup \{k\}$. The construction of the automaton relies on these transitions.

Definition 5.3 *Let \mathcal{A}_N be the following automaton:*

- The alphabet is $\{1, 2, \dots, N-1\}$.

- The states are the subsets of $[1, N-1]$.
- The transitions are defined as follows: if S and T are two subsets of $[1, N-1]$, there is an arrow labeled $k \in [1, N-1]$ that goes from S to T iff
 1. $T = S \cup \{k\}$;
 2. $S \cap [1, k-1] = [i, k-1]$, for some $i \in [1, k]$.
- The initial state is the empty set and all states are terminal.

Notice that with the previous definition of the transitions, this allows $S \cap [1, k-1]$ to be empty. The next theorem establishes the connection between \mathcal{A}_N and L_N .

Theorem 5.4 *The language recognized by the automaton \mathcal{A}_N is L_N .*

Proof – Using Lemma 5.2, one can easily prove by induction on the length of σ that if σ is an element of $E_{n,N}$, $X(\sigma)$ is the ending state of the automaton when reading the word $w(\sigma)$. Hence, all the words of L_N are recognized by the automaton \mathcal{A}_N .

Conversely, let $v = uk$ (with $k \in [1, N-1]$) be a word recognized by \mathcal{A}_N . By induction, we can assume that there exists $\sigma \in E_{n,N}$ such that u equals $w(\sigma)$. According to the previous result, the automaton \mathcal{A}_N ends in the state $X(\sigma)$ when reading u . By definition of the transitions of \mathcal{A}_N , one must have $X(\sigma) \cap [1, k-1] = [i, k-1]$ for some $i \in [1, k]$. It implies then that $k-1$ is smaller than $b(\sigma)$ and hence that the permutation associated with v belongs to $E_{n,N}$ according to Lemma 5.2. ■

Figure 3 shows the automaton \mathcal{A}_4 .

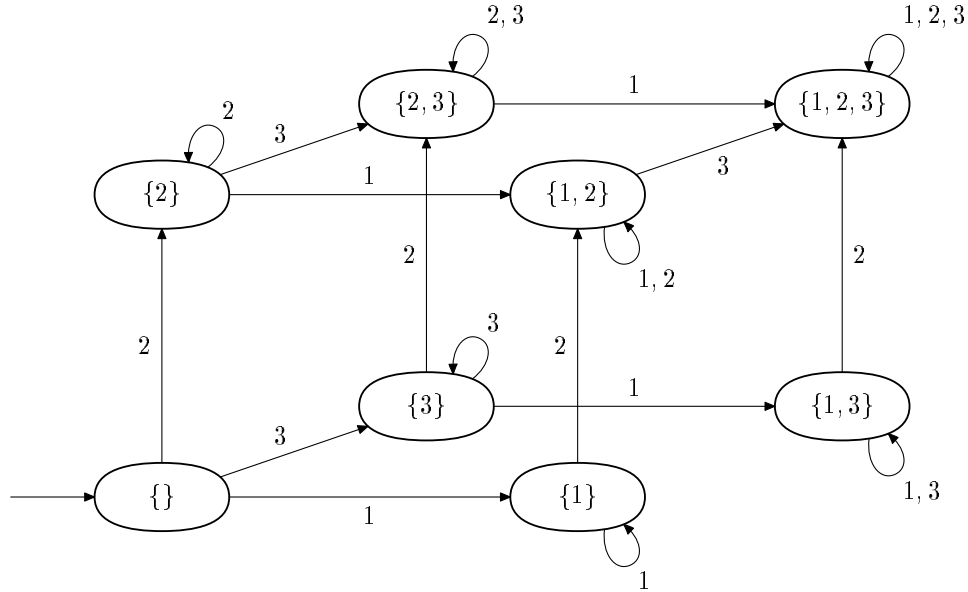

Figure 3: The automaton \mathcal{A}_4 .

Note 5.5 One can remark that the automaton \mathcal{A}_N is obtained as follows: take two exact copies of \mathcal{A}_{N-1} , add the element $N-1$ to all states of the second copy and add arrows labeled by $N-1$ from a state S to $S \cup \{N-1\}$ if S satisfies $S = \emptyset$ or $S = \{N-1\}$ or $N-2 \in S$. Notice that this property can be used to recursively build \mathcal{A}_N .

One can associate with every language L defined on some alphabet A the Poincaré series defined by

$$\mathcal{D}_L = \sum_{n \geq 0} |L \cap A^n| t^n.$$

This series is also called the series of length distribution associated with the language L . We recall that the series \mathcal{D}_L is rational when L is a rational language.

Theorem 5.6 *For every $N \geq 1$, there exists a polynomial $P_N(t) \in \mathbb{Z}[t]$ such that:*

$$\mathcal{D}_{L_N} = \frac{P_N(t)}{(1 - (N - 1)t) \prod_{i=1}^{N-3} (1 - it)^{\lfloor \frac{N}{i+1} \rfloor}}.$$

We just give an idea of the proof: one has first to establish that all the poles of \mathcal{D}_{L_N} are of the form $\{\frac{1}{i}, i \in [1, N - 1]\}$. This can be achieved by partitioning the language \mathcal{D}_{L_N} into a finite number of smaller languages which series are of the previous form. Then, looking carefully to their series, one can prove that the power of a given pole i is bounded by $\lfloor N/i + 1 \rfloor$. To conclude to the theorem, it then suffices to prove that $N - 2$ is not a pole of \mathcal{D}_{L_N} . This is achieved by reducing the automaton.

Corollary 5.7 *Let us denote by $e_{n,N}$ the cardinality of $E_{n,N}$.*

$$e_{n,N} \underset{n \rightarrow +\infty}{\sim} C(N - 1)^n.$$

Based on numerical evidences, we however conjecture a finer formula for the equivalent of $e_{n,N}$.

Conjecture 5.8 *We conjecture that*

$$e_{n,N} = \frac{(N - 1)^{n-2}}{((N - 2)!)^2} + \frac{(N - 3)^{n-3}}{((N - 4)!)^2 \times (N - 4)} + O((N - 4)^n).$$

One can compare this result to the asymptotics of $d_{n,N}$ found by Regev (see [17]).

Corollary 5.9 *One has:*

$$d_{n,N} \underset{n \rightarrow +\infty}{\sim} A(N) \sqrt{n}^{N-2} \left(\frac{1}{n}\right)^{\frac{(N-2)(N+1)}{2}} (N - 1)^{2n},$$

where $A(N)$ only depends on N .

References

- [1] BARCUCCI E., DEL LUNGO A., LANINI S., MACRI M., PINZANI R., *The inversion number of some permutations with forbidden subsequences*, Proc. of SOCA'96, Tianjin, 21-32, 1996.
- [2] BARCUCCI E., DEL LUNGO A., PERGOLA E., *Permutations with one forbidden subsequence of increasing length*, [in FPSAC'97, C. Krattenthaler, Ed.], 49-60, 1997.

- [3] BONA M., *Permutations avoiding certain patterns: the case of length 4 and some generalizations*, [in FPSAC'96, D. Stanton, Ed.], 47-58, 1996.
- [4] BONA M., *P-recursiveness for pattern avoidance*, [in FPSAC'97, C. Krattenthaler, Ed.], 107-118, 1997.
- [5] BOSE P., BUSS J.F., LUBIW A., *Pattern matching for permutations*, Lect. Notes in Comput. Sci., **709**, 200-209, 1993.
- [6] DIPPER R., DONKIN S., *Quantum GL_n* , Proc. London Math. Soc., **63**, 165–211, 1991.
- [7] DUCHAMP G., KROB D., LASCoux A., LECLERC B., SCHARF T., THIBON J.Y., *Euler-Poincaré characteristic and polynomial representations of Iwahori-Hecke algebras*, Publ. RIMS, Kyoto Univ., **31**, 179–201, 1995.
- [8] DULUCQ S., GIRE S., WEST J., *Permutations à motifs exclus et cartes planaires non séparables*, Discrete Math, **153**, 85-103, 1996.
- [9] GESSEL I.M., *Symmetric functions and P-recursiveness*, J. of Comb. Th. (Series A), **53**, 257–285, 1990.
- [10] GESSEL I.M., WEINSTEIN J., WILF H.S., *Lattice Walks in Z^d and Permutations with No Long Ascending Subsequences*, Electronic J. of Combinatorics, Vol. 5(1), R2, 1998.
- [11] GUIBERT O., *Combinatoire des permutations à motifs exclus en liaison avec mots, cartes planaires et Tableaux de Young*, PhD Thesis, Univ. Bordeaux 1, 1995.
- [12] JIMBO M., *A q -Analogue of $U_q(\mathcal{G}l(N+1))$, Hecke Algebra, and the Yang-Baxter Equation*, Let. in Math. Phys., **11**, 247–252, 1986.
- [13] KNUTH D.E., *The art of computer science – Volume 1 : Fundamental algorithms*, Addison Wesley, 1968.
- [14] KROB D., THIBON J.Y., *Noncommutative symmetric functions IV: Quantum linear groups and Hecke algebras at $q = 0$* , J. of Alg. Comb., **6**, (4), 339-376, 1997.
- [15] KROB D., THIBON J.Y., *Noncommutative symmetric functions V: A crystalizable version of $U_q(\mathcal{G}l_N)$* , LITP Technical Report, 1996.
- [16] MACDONALD I.G., *Notes on Schubert polynomials*, Public. LACIM, **6**, Montréal, 1991.
- [17] REGEV A., *Associated values for degree associated with strips of Young diagrams*, Adv. in Math., **41**, 115-136, 1981.
- [18] SCHENSTED C., *Longest increasing and decreasing subsequences*, Canad. J. Math., **13**, 178–191, 1961
- [19] SCHMIDT F., SIMION R., *Restricted permutations*, Eur. J. of Comb., **6**, 383–406, 1985.
- [20] WEST J., *Permutations with restricted subsequences and stack-sortable permutations*, PhD Thesis, MIT, 1990.
- [21] WEST J., *Generating trees and forbidden subsequences*, [in FPSAC'94, Dimacs], 441–450, 1994.