



**HAL**  
open science

## Height-arrow Model

Dominique Rossin, Arnaud Dartois

► **To cite this version:**

Dominique Rossin, Arnaud Dartois. Height-arrow Model. FPSAC-SFCA 04, 2004, Vancouver, Canada. hal-00015563

**HAL Id: hal-00015563**

**<https://hal.science/hal-00015563>**

Submitted on 9 Dec 2005

**HAL** is a multi-disciplinary open access archive for the deposit and dissemination of scientific research documents, whether they are published or not. The documents may come from teaching and research institutions in France or abroad, or from public or private research centers.

L'archive ouverte pluridisciplinaire **HAL**, est destinée au dépôt et à la diffusion de documents scientifiques de niveau recherche, publiés ou non, émanant des établissements d'enseignement et de recherche français ou étrangers, des laboratoires publics ou privés.

## Height Arrow Model

Arnaud Dartois and Dominique Rossin

**ABSTRACT.** We study in this article the characteristics of the so-called Height-Arrow Model (HAM), introduced by physicists as an extension of the Abelian Sandpile Model and the Eulerian Walker. We show that recurrent configurations of this model form an Abelian group and that classical algorithms such as the recurrence criterion or the burning algorithm for the ASM could be extended to the HAM.

**RÉSUMÉ.** Dans cet article nous étudions le modèle dit hauteur-orientation introduit par des physiciens comme une généralisation du modèle du Tas de Sable Abélien et du Marcheur Eulérien. Nous montrons que les configurations récurrentes du système forment un groupe Abélien dont le cardinal est lié aux arbres couvrants du graphe sous-jacent. De plus, nous généralisons quelques algorithmes classiques connus pour le modèle du Tas de Sable Abélien comme le critère de récurrence ou l'algorithme de mise à feu.

### Introduction

Bak, Tang and Wiesenfeld [BTW87] introduced in 1987 a simple model based on a cellular automaton which depicted the critical behaviour of self-organized systems. This model has been extensively studied by physicists [DM91], [DRSV95], and combinatorists [Big99], [Big96], [CR00], [CGB02].

This system presents two different aspects:

- A dynamical approach. Starting from a given configuration, we let the system evolve and the series of configurations it reaches under the action of the evolution rules describes its dynamic.
- The second aspect was pointed out by Dhar, Ruelle, Sen and Verma [DRSV95]. The space of recurrent configurations -i.e. those which can appear after a long evolution of the system- is an Abelian group.

The Eulerian Walkers Model (EWM) was introduced by Priezzhev, Dhar and al. in [PDDK02]. This model shares with the Abelian Sandpile Model (ASM) the Abelian group property. Both models involve a rooted map  $G$ , where some particles (also called grains or walkers sometimes) could be put on every vertex except the sink. Then the system evolves according to a toppling rule. At the end of [PDDK02] a general model is proposed which generalizes EWM and ASM. This paper is a detailed analysis of this model called Height Arrow Model (HAM).

In the first part we give basic definitions of the model and the underlying structure of combinatorial map. Then, we study the configurations of the system and show that some of them, called recurrent ones, are closely related to the recurrent of the ASM. In the last part we study the group associated to each of the different model and point out correlations between them.

---

1991 *Mathematics Subject Classification.* Primary 05C90, 05C45; Secondary 68R05.

*Key words and phrases.* sandpile, eulerian walker.

## 1. Definition of the model

**1.1. Configurations of the HAM.** The HAM is usually described with respect to an order for the edges around a vertex. Hence, the natural structure to define the HAM is a combinatorial map. This is the embedding of a graph on a surface.

DEFINITION 1.1. A *combinatorial map* on a (finite) set  $B$  is a pair of permutations  $(\sigma, \alpha)$  of  $B$  such that:

- (1)  $\alpha$  is a fixed-point free involution,
- (2) the group  $\langle \sigma, \alpha \rangle$  generated by the two permutations is transitive.

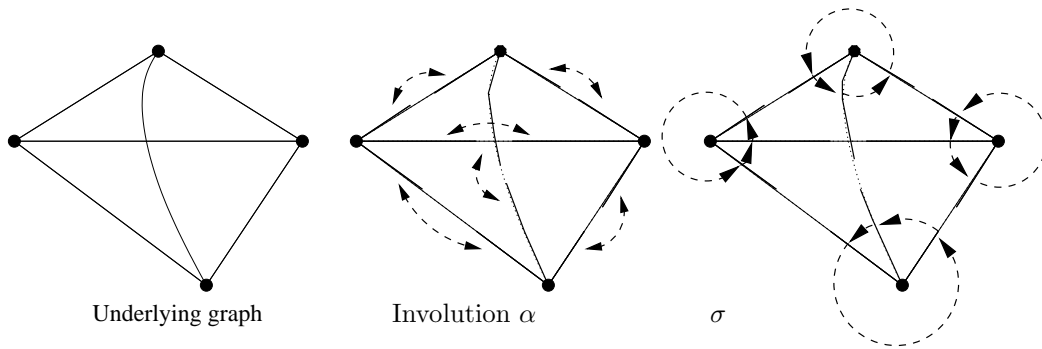

FIGURE 1. A combinatorial map  $(\sigma, \alpha)$

The elements of  $B$  are called the *half-edges* (also called *brins*). The cycles of  $\sigma$  are the *vertices* and those of  $\alpha$  are the *edges*. The pair of partitions  $(V, E)$  of  $B$  induced by the vertices and the edges constitutes the *underlying graph* of the map. In particular  $|B| = 2|E|$ . Property (2) implies that the underlying graph of a combinatorial map is connected. We say that a combinatorial map is *simple* if its underlying graph is simple i.e., it contains neither parallel edges nor loops. For more details on maps, see [CM92].

Such a map can be seen as a graph where the edges around each vertex are ordered.

A  $\tau$ -map is a pair  $\mathcal{M}^\tau = (\mathcal{M}, \tau)$  where  $\mathcal{M}$  is a combinatorial map and  $\tau \in \mathbb{N}^V$  a vector of integers such that  $\tau_i$  is an attribute of vertex  $i$  satisfying  $0 \leq \tau_i \leq d_i$ , where  $d_i$  is the degree of vertex  $i$  (the size of the orbit of  $\sigma$  for half-edges adjacent to  $i$ ). A  $\tau_q$ -map is a  $\tau$ -map where a vertex  $q$  is distinguished and verifies  $\tau_q = d_q$ . This vertex will be called the *sink*.

DEFINITION 1.2. Given a  $\tau_q$ -map, a *configuration* of the HAM is a pair  $u = (h, \omega)$  where:

$$\forall i \neq q, \begin{cases} h(i) \in \mathbb{Z} \\ w(i) \text{ is an half-edge adjacent to } i \end{cases}$$

The application  $h$  is called the height configuration of  $u$  and  $\omega$  the arrow configuration or orientation of  $u$ .

For example, figure 2 shows a configuration on a  $\tau_q$ -map. The attribute  $\tau$  is represented by integers outside each vertex. Height  $h$  is represented by integers inside vertices and  $\omega$  by an arrow going out each vertex.

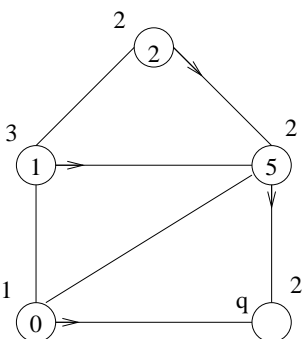

FIGURE 2. A  $\tau_q$ -map and a configuration on it

A configuration is *stable* if  $h(i) < \tau_i$  for all vertices  $i$  except  $q$ . Otherwise, it is called *unstable*. In this case, as in figure 2, a vertex can topple. In this example vertices with height 2 and 5 are unstable and can topple.

**Toppling rule** If a vertex  $i$  is unstable then repeat  $\tau_i$  times the following operations:

- (1) change the arrow from  $\omega(i)$  to  $\sigma(\omega(i))$ ,
- (2) send a grain along the new arrow  $\omega(i)$  towards half-edge  $\alpha(\omega(i))$  till the next vertex  $j$ .  
Then,  $h(i) \leftarrow h(i) - 1$  and  $h(j) \leftarrow h(j) + 1$ .

In this process we say that half-edges  $\sigma(\omega(i)), \sigma^2(\omega(i)), \dots, \sigma^{\tau_i}(\omega(i))$  are *visited*.

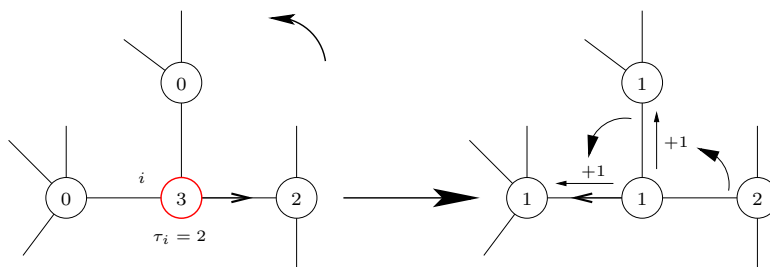

FIGURE 3. Toppling rule

We retrieve the Eulerian Walker Model when  $\tau_i = 1$  for every vertex and the Abelian Sandpile Model when  $\tau_i = d_i$ .

**1.2. Relaxation of a configuration.** Let  $u$  be a configuration such that vertex  $i$  is unstable, and let  $u'$  be the configuration obtained from  $u$  by toppling vertex  $i$ . We will note by  $u \xrightarrow{i} u'$  this toppling operation, and more generally by  $u \xrightarrow{s} u'$  if  $u'$  is obtained from  $u$  by the sequence  $s$  of topplings.

**DEFINITION 1.3.** If  $u$  is an unstable configuration of the HAM on a  $\tau_q$ -map  $\mathcal{M}_q^\tau$  then we call *relaxation* of the configuration  $u$  every sequence  $s$  of topplings that transforms  $u$  into a stable configuration  $u'$ .

The relaxation process is not unique. In fact in an unstable configuration, more than one vertex could be unstable. Thus, the choice of the vertex which will topple at a time step leads to several relaxations. As mentioned in the article of Priezzhev, Dhar and al. [PDDK02], the topplings could



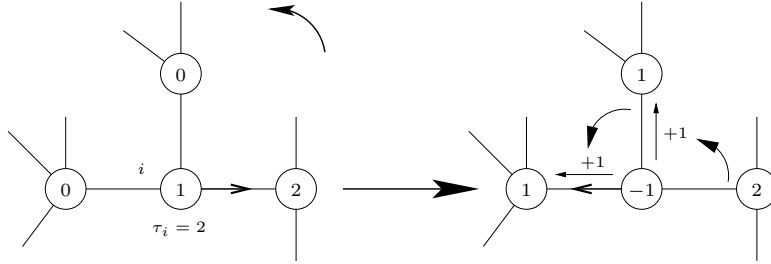

FIGURE 5. Example of a forced toppling of a stable vertex

## 2. Recurrent configurations of the HAM

### 2.1. Recurrent configurations.

DEFINITION 2.1. Let  $\mathcal{C}_\omega$  be the following Markov chain:

- $(0, \omega)$  is the initial state.
- A transition is made of two steps:
  - Addition of a grain which increases the height by one on a random vertex.
  - Relaxation of the configuration.

We will denote by  $E_\omega$  the set of recurrent configurations (states) of  $\mathcal{C}_\omega$  and by  $\mathcal{E}$  the set of all recurrent configurations for all possible starting orientations.

Note that the initial state of the Markov chain is  $(0, \omega)$ . If we choose any other initial height configuration  $h$ , then the recurrent configurations associated to the Markov chain would have remained  $E_\omega$ . Indeed the stable configuration obtained after relaxation of  $(\text{Max}(h, 0), \omega)$  belongs to both Markov chains.

**2.2. Extended recurrence criterion.** In the model, for each vertex  $i$ , a natural quantity depending on  $\tau_i$  and  $d_i$  is meaningful: the *multiplicity factor*. The multiplicity factor  $\lambda_i$  is defined for each vertex  $i$  by:

$$\lambda_i = \frac{\text{lcm}(\tau_i, d_i)}{d_i} = \frac{\tau_i}{\text{gcd}(\tau_i, d_i)}$$

Then the multiplicity factor of the map is defined as  $\lambda = \text{lcm}_{i \in V} \{\lambda_i\}$ .

The factor  $\lambda_i$  corresponds for each vertex to the smallest number of times any half-edge adjacent to  $i$  is visited in order to return in the same arrow state by toppling operations. In figure 6,  $\tau_i = 2$  for the considered vertex. We must topple this vertex at least 5 times in order to return to the same orientation state. During these topplings each adjacent half-edge has been visited twice.

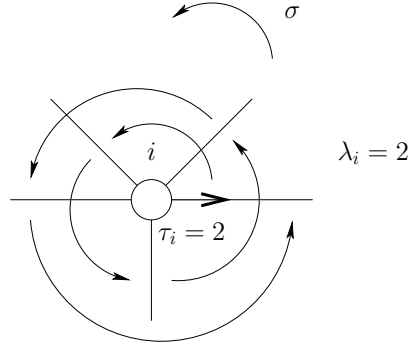

FIGURE 6. Graphical interpretation of the multiplicity factor of a vertex

LEMMA 2.2. *Let  $u = (h, \omega)$  be a configuration of the system. Let  $s = s_1 s_2 \dots s_k$  be a series of topplings of any vertices (sink included) starting from  $u$  such that after performing toppling  $s_k$ , the system returns in configuration  $u$ . Then, in this process, each half-edge of the map is visited  $m\lambda$  times with  $m \in \mathbb{N}$ .*

PROOF. Notice that when a vertex topples, its first edge is visited, then its second one and so on, so that no edge could be visited twice before all the other ones are visited once.

Then, as the orientation of a vertex  $i$  is the same between the beginning and the end of the process, this means that each half-edge adjacent to  $i$  is visited the same number of times  $m_i \lambda_i$ .

Suppose now that there exist  $i, j$  such that  $i \neq j$  and  $m_i \lambda_i \neq m_j \lambda_j$ . Let  $i_0$  be a strict minimum for  $m_i \lambda_i$ ; there is no  $j$  such that  $m_j \lambda_j < m_{i_0} \lambda_{i_0}$  and there exists vertex  $j$  adjacent to vertex  $i_0$  such that  $m_j \lambda_j > m_{i_0} \lambda_{i_0}$ . This vertex received  $\sum_{i \text{ adjacent to } i_0} m_i \lambda_i$  grains but sends  $d_{i_0} m_{i_0}$  grains. So it topples strictly less grains than it receives which contradicts the conservation law of grains. Finally, all  $m_i \lambda_i$  are equal and so  $m_i \lambda_i = m\lambda$ .  $\square$

THEOREM 2.3. *Let  $\mathcal{M}_q^\tau$  be a  $\tau_q$ -map. Let  $u$  be a stable configuration. Suppose that we topple  $k$  times the sink and that the relaxation of this new configuration is  $u$ . Then, the relaxation of the configuration obtained by toppling the sink  $\lambda$  times in  $u$  is  $u$ .*

PROOF. Since  $\tau_q = d_q$ , by preceding lemma,  $k = m\lambda$ . We must show that in fact taking  $m = 1$  is also possible.

Consider the following process:

Repeat  $m$  times the following two-steps operation:

- (1) Topple the sink  $\lambda$  times.
- (2) Relax the new configuration.

At the end of the process, the resulting configuration is  $u$  because of the confluence of the relaxation.

In this process we look at the series of half-edges  $s^i, 1 \leq i \leq m$  which appear in (a), (b) of the time step  $i$ . Suppose that one half-edge appears strictly more than  $\lambda$  times. Take the first one that does so. Then, it means that the corresponding vertex  $i$  received strictly more than  $\lambda d_i$  grains. Hence it received strictly more than  $\lambda$  grains along at least one half-edge. This contradicts the fact that we take the first half-edge which appears twice. Therefore each half-edge appears at most  $\lambda$  times. As at the end of the  $m^{\text{th}}$  series, every half-edge appears  $m\lambda$  times, each half-edge appears exactly  $\lambda$  times in each series  $s^i$ . Hence it is easy to check that if every half-edge appears  $\lambda$  times, the configuration obtained is the same.  $\square$

From this theorem we can now generalize Dhar's criterion [Dha90] for characterizing recurrent configurations.

**THEOREM 2.4.** *[Extended recurrence criterion] A configuration  $u$  is recurrent if and only if when toppling  $\lambda$  times the sink in  $u$ , the relaxation of the new configuration gives  $u$ .*

**PROOF.** The proof is very straightforward.

First we can show that if there is a recurrent configuration that verifies the conditions of Theorem 2.3, then any recurrent configuration of the same orbit verifies them. Now, let consider the process of toppling the sink and relaxing. If we repeat this process starting from a recurrent configuration, we eventually find a recurrent configuration of the same orbit that verifies the condition of Theorem 2.3. Hence, any recurrent configuration satisfies the criterion.

The reciprocity is immediate by definition of recurrence. □

### 3. HAM group of recurrent configurations

**3.1. Arrow equivalent configurations.** We now classify the recurrent configurations into different classes. This classification comes from the following observations:

- In the Abelian Sandpile Model, the orientations are irrelevant. In fact  $\tau_i = d_i$  for each vertex. Thus, when you topple a vertex, the arrow makes one turn and return in the same position.
- In the Eulerian Walker problem, heights are irrelevant as they are all equal to 0 ( $\tau_i = 1$  for all vertices).

For the HAM model, we try to separate the influence and the correlation between height and orientations.

**DEFINITION 3.1.** Let  $\omega_1$  and  $\omega_2$  be two different orientations. We say that  $\omega_1$  is equivalent to  $\omega_2$  and we write  $\omega_1 \sim_o \omega_2$  if and only if  $E_{\omega_1} = E_{\omega_2}$ .

By extension, we say that two configurations  $u_1 = (h_1, \omega_1)$ ,  $u_2 = (h_2, \omega_2)$  are arrow equivalent and we write  $u_1 \sim_o u_2$  if  $\omega_1 \sim_o \omega_2$ . Note that  $\sim_o$  is an equivalence relation.

**LEMMA 3.2.** *Two configurations  $u_1 = (h_1, \omega_1)$  and  $u_2 = (h_2, \omega_2)$  are arrow equivalent on a  $\tau_q$ -map  $\mathcal{M}_q^\tau$  if and only if:*

$$\forall i \neq q, \exists k_i \in \mathbb{N}, \omega_{1,i} = \sigma^{k_i \tau_i}(\omega_{2,i})$$

**PROOF.** If  $u_1$  and  $u_2$  are arrow equivalent, we can get from  $u_1$  and  $u_2$  a common configuration by additions of grains and toppling operations. When adding a grain, the orientations stay the same and when toppling a vertex  $i$ , the orientation rotates by  $\sigma^{\tau_i}$ . Thus  $\omega_1$  and  $\omega_2$  respect the above property (see figure 7).

Conversly, if two configurations  $u_1$  and  $u_2$  satisfy the above property, then the stable configuration of  $(k\tau, \omega_2)$  obviously belongs to the Markov chain initiated by  $(0, \omega_2)$ , but also by the one initiated by  $(0, \omega_1)$ . Hence  $u_1$  and  $u_2$  are arrow equivalent. □

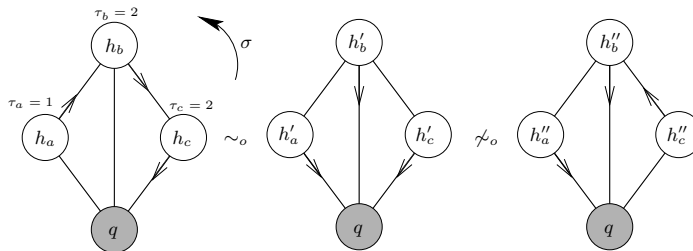

FIGURE 7. Example of arrow equivalent configurations



**3.2. HAM Abelian group.** In this part, we show how the Abelian Sandpile Group can be generalized in this new model.

DEFINITION 3.3. For all vertices  $i \neq q$ , we define the set of operators  $a_i$  as the addition of a grain on vertex  $i$  followed by the relaxation.

Those operations form obviously a semigroup acting on any class of arrow equivalent configurations.

LEMMA 3.4. *The operators commute:*

$$\forall i, j \neq q, [a_i, a_j] = 0$$

PROOF. This comes from the confluence property of topplings. If there are two different unstable vertices at a given time, then you can make the topplings in any order and the resulting stable configurations are the same.  $\square$

THEOREM 3.5. *Let  $\omega$  be an orientation, the operators  $\{a_i\}_{i \neq q}$  form an Abelian group called HAM group acting on  $E_\omega$ . We have the following relations:*

$$\forall i, a_i^{\lambda_i d_i} = \prod_{\{i,j\} \in E} a_j^{\lambda_i}$$

PROOF. By Theorem 2.4 and the extended recurrence criterion, it is clear that  $a_i$  is invertible when acting on  $E_\omega$ .

If  $\Delta$  is the Laplacian matrix of the graph  $(V, E)$  associated to the map, then:

$$\forall i \neq q, \prod_{j \neq q} a_j^{\lambda_i \Delta_{i,j}} = I \quad [r_i].$$

Moreover, any relations between operators can be expressed in terms of  $r_i$ . Each one corresponds to the toppling of a vertex.  $\square$

Now, we study the repartition of the recurrent configurations between classes  $E_\omega$ . Thus, we define the graph  $W$  to be the directed graph where:

- Vertices are recurrent configurations.
- Edges are the application of operator  $a_i$  or  $a_i^{-1}$ .

LEMMA 3.6. *The graph  $W$  is the graph whose connected components are the equivalence classes of the relation  $\sim_o$  restricted to  $\mathcal{E}$ .*

The above lemma is the direct consequence of the following one.

LEMMA 3.7. *Let  $u$  and  $u'$  two recurrent configurations. They are connected within  $W$  (i.e., there is a sequence of  $a_i$ 's, such that  $(\prod_{i \in \mathcal{I}} a_i)u = u'$ ) if and only if there is an orientation  $\omega$  such that  $u$  and  $u'$  are in  $E_\omega$ .*

PROOF. Since  $\mathcal{G} = \langle a_i, r_i \rangle$  is a group acting on  $\mathcal{E}$ , the connected components of  $W$  are the same as the ones of the graph obtained from  $W$  by deleting the edges  $a_i^{-1}$ . Hence we restrict ourselves to this graph.

Since  $u$  is recurrent, there is an orientation  $\omega$  such that  $u$  is in  $E_\omega$ .

Suppose that  $u$  and  $u'$  are connected within  $W$ . Then we can write  $u' = (\prod_{i \in \mathcal{I}} a_i)u$ . Hence  $u'$  can be obtained by beginning the Markov chain by the configuration  $(0, \omega)$  i.e.,  $u' \in E_\omega$ .

Suppose that both  $u$  and  $u'$  are in  $E_\omega$ . Then they are recurrent in the Markov chain beginning by  $(0, \omega)$ . Thus, there is a vector  $g$  such that when we add  $g_i$  grains to each vertex  $i$  of configuration  $u$  and relax, we get  $u'$ . It means that  $(\prod_i a_i^{g_i})u = u'$  i.e.,  $u$  is connected to  $u'$  in  $W$ . By invertibility, we get the fact that  $u'$  is connected to  $u$  in  $W$ .  $\square$

**THEOREM 3.8.** *Let  $\omega$  be an orientation. Then the recurrent configurations in  $E_\omega$  are equiprobable.*

**PROOF.** The transition matrix of the associated Markov chain is irreducible by Lemma 3.6. Hence there exists a unique stationary probability. Since the equiprobability is obviously valid, it is the solution.  $\square$

**Eulerian Walker :** In the Eulerian Walker,  $\tau_i = 1$  for all vertices. Thus there is only one possible height function which is 0 everywhere. In this case, there is only one equivalence class -one connected component in  $W$ - for  $\sim_\omega$ .

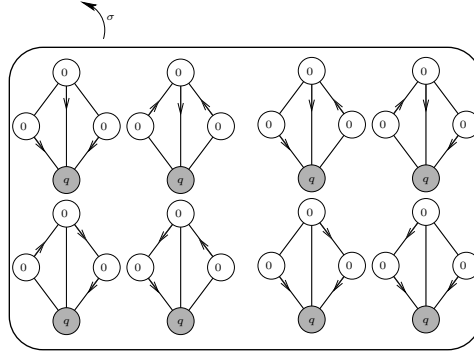

FIGURE 8. Equivalence classes for  $\sim_\omega$  in the EWM.

**Abelian Sandpile Model (ASM) :** In the ASM,  $\tau_i = d_i$  for all vertices. Thus all configurations in a class have the same orientations for the vertices.

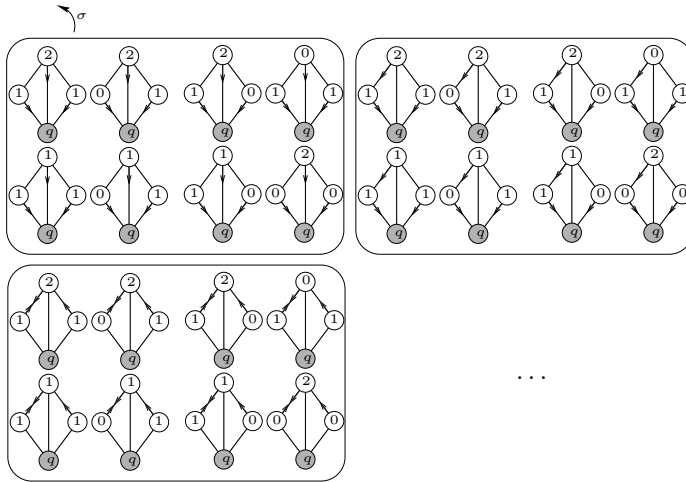

FIGURE 9. Equivalence classes of  $\sim_\omega$  for the ASM.

Notice that all classes have equal cardinality. We denote by  $\Delta$  the Laplacian matrix of the underlying graph, and by  $\Delta^q$  its  $q$ -minor, i.e. where row and column  $q$  are removed.

**PROPOSITION 3.9.** The HAM group  $\mathcal{G} = \langle a_i; r_i \rangle$  is the one associated to the matrix  $(\lambda_i \Delta_i^q)_i$  with  $i \neq q$ . Then  $|E_\omega| = |\mathcal{G}| = (\prod_i \lambda_i) |\det(\Delta^q)|$ . The number of spanning trees of the underlying graph is  $|\det(\Delta^q)|$ .

Moreover,  $|\mathcal{E}| = \xi |\mathcal{G}|$  where  $\xi = \prod_{i \neq q} \gcd(\tau_i, d_i)$  i.e.  $|\mathcal{E}| = (\prod_i d_i) |\det(\Delta^q)| = \xi |\mathcal{G}|$ .

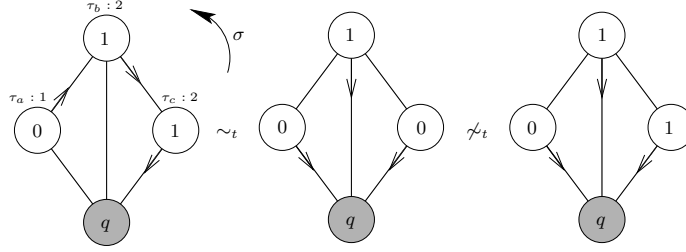

FIGURE 10. The last configuration is not toppling equivalent with the two others, but obviously arrow equivalent with them.

PROOF. From the above remarks,  $(\lambda_i \Delta_i^q)_i$  with  $i \neq q$  is the matrix of the group  $\mathcal{G}$ . Hence  $|\mathcal{G}| = \det(\lambda_i \Delta_i^q), i \neq q$ , and we get the result by multilinearity of the determinant.

We can also directly guess that every  $E_\omega$  have the same cardinality because such a set is the result of the action of a group on a configuration.

The fact that  $|\det(\Delta^q)|$  is the number of spanning trees of the underlying graph comes from the matrix-tree theorem [WVL92].

□

#### 4. Extended properties

We saw in the last section an equivalence relation among configurations. The relation helps us to determine the cardinality of the set of recurrent configurations. We now define some other relations in order to build a natural addition on recurrent configurations like in the ASM. In the ASM, the anti-toppling of a vertex is equivalent to the toppling of all the other vertices. In the HAM, this relation is sometimes false. When  $\lambda \neq 1$  the behaviour of the HAM differs from the ASM. Thus, we introduce two different equivalence relations, the first one  $\sim_t$  which is the ASM equivalence and the second one  $\sim_q$  where the factor  $\lambda$  is relevant.

##### 4.1. Toppling equivalence $\sim_t$ .

DEFINITION 4.1. Let  $u = (h, \omega)$  and  $u' = (h', \omega')$  be two configurations. We say that  $u$  and  $u'$  are toppling equivalent, and we note  $u \sim_t u'$  if and only if  $u$  can be obtained from  $u'$  by a sequence of (forced) topplings and anti-topplings of any vertex.

As we mentioned above, this relation is finer than  $\sim_o$ . It corresponds to the classical equivalence relation on the Abelian Sandpile Model. In the ASM, there is only one recurrent configuration in each equivalence class.

In the following this result is extended to the HAM.

PROPOSITION 4.2.  $\sim_t$  is an equivalence relation on the set of all configurations. Moreover,  $\sim_t \implies \sim_o$ .

PROOF. The fact that  $\sim_t$  is transitive, reflexive and symmetric is obvious. From Definition 4.1, if  $u \sim_t u'$ , then:

$$\exists k, \forall i, \omega_i = \sigma^{k_i \tau_i}(\omega'_i).$$

In particular it means that  $\omega \sim_o \omega'$  i.e.,  $u \sim_o u'$ . □

A direct corollary of Theorem 2.4 is the following proposition:

PROPOSITION 4.3. The equivalence classes of  $\sim_t$  have same cardinality  $\lambda$ .

Thus we can define a finer (if  $\lambda > 1$ ) equivalence relation:

DEFINITION 4.4. Let  $u = (h, \omega)$  and  $u' = (h', \omega')$  be two configurations. We say that  $u$  and  $u'$  are *sink equivalent*, and we note  $u \sim_q u'$  if and only if  $u$  can be obtained from  $u'$  by a sequence of (forced) topplings and anti-topplings of any vertex except  $q$ .

This relation is more restrictive than  $\sim_t$ . If  $\omega$  is an orientation of a  $\tau_q$ -map then we denote by  $\mathcal{P}^q(u)$  the equivalence class of  $u$  for  $\sim_q$ .

PROPOSITION 4.5.

$$\sim_q \implies \sim_t \implies \sim_o$$

We also have the converse relation for inclusion of equivalence classes.

Moreover,  $\lambda = 1 \iff \sim_q = \sim_t$

PROOF. The first inclusions are straightforward from the definition of equivalence relations.

The second point is a corollary of the following fact: toppling  $\lambda$  times the sink  $q$  is rigorously equivalent to anti-toppling  $\frac{\lambda d_i}{\tau_i}$  times vertex  $i$  for all vertices  $i$  except  $q$ . Since there do not exist  $k < \lambda$  such that toppling  $k$  times the sink is equivalent to toppling other vertices,  $\sim_t$  and  $\sim_q$  correspond to the same equivalence relation if and only if  $\lambda = 1$ .

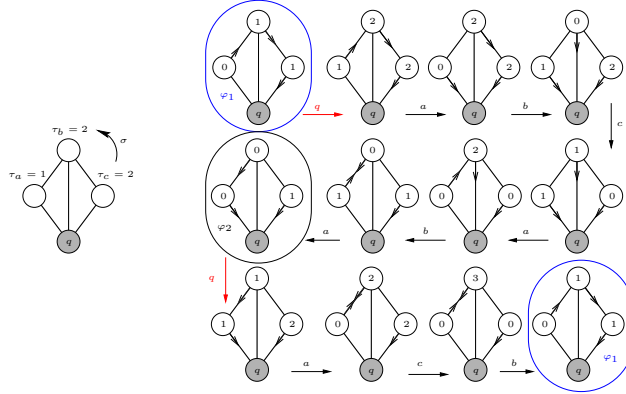

FIGURE 11. Non equivalence between  $\sim_t$  and  $\sim_q$ .

□

If  $u$  and  $u'$  are two configurations. Then they are sink equivalent if and only if  $u$  can be obtained from  $u'$  by a sequence of topplings of any vertices with the restriction that the sink  $q$  is toppled  $k\lambda$  times for some integer  $k$ .

The proof is quite straightforward. From Theorem 2.4, we can express the anti-toppling of any vertex  $i$  in term of topplings of vertices. If every vertex topples  $d_i \lambda / \tau_i$  times except vertex  $i$  that topples  $d_i \lambda / \tau_i - 1$  times, then it is as if the vertex  $i$  anti-topples. Hence if  $u \sim_q u'$ ,  $u$  can be obtained from  $u'$  by a sequence of topplings of vertices with the restriction that the sink  $q$  can only topples a number of times multiple of  $\lambda$ .

This last remark proves that there is only one recurrent configuration in each equivalence class of  $\sim_q$ .

PROPOSITION 4.6.

$$|E_\omega / \sim_q| = |E_\omega|$$

From these remarks on  $\sim_q$  arises a natural order on configurations noted  $\succ_q$ .

DEFINITION 4.7. Let  $u$  and  $u'$  be two configurations. We say that  $u \succ_q u'$  if  $u'$  could be obtained from  $u$  with a series of (forced) topplings of vertices ( $\neq q$ ).

This order is a partial order on the infinite set of configurations of the HAM. Moreover, any class  $\mathcal{P}^q(u)$  is an infinite distributive lattice for this order. If we denote by  $u_1, \dots, u_\lambda$  the  $\lambda$  distinct recurrent configurations of a class for  $\sim_t$ , then each one belongs to a different class for  $\sim_q$ . We go from one class to the other by toppling  $q$  (cf figure 12).

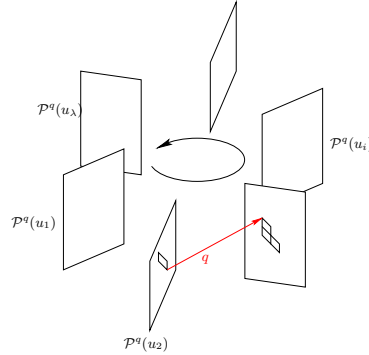

FIGURE 12. A class of  $\sim_t$  splits into  $\lambda$  classes  $\mathcal{P}^q(u)$  of  $\sim_q$ .

**4.2. Extended burning algorithm.**

**THEOREM 4.8.** *Let  $u$  be a configuration. Then there exists a unique recurrent configuration  $u'$  sink-equivalent to  $u$ . This configuration is the fixed point of the following process:*

- (1) *Topple  $\lambda$  times the sink in  $u$ .*
- (2) *Relax the configuration obtained.*

*We call this process extended burning algorithm (see figure 13).*

*Moreover if  $u$  is non-negative then the number of iterations of the previous process is bounded by a characteristic factor of  $\mathcal{M}_q^+$ .*

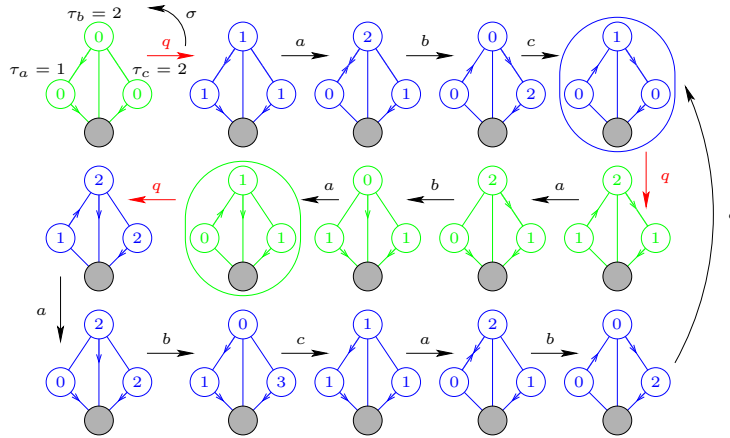

FIGURE 13. Extended burning algorithm

**4.3. Addition.** We now define an addition for recurrent configurations. The main problem between HAM and ASM is that the orientations could be different between two recurrent configurations.

So let  $\omega$  be an orientation. We call  $\omega$ -representation of the configuration  $u = (h, \omega_1)$  the configuration  $u' = (h', \omega)$  obtained from  $u$  by anti-toppling each vertex  $i$  the smallest number of times to obtain the same orientation as  $\omega$ . If  $u = (h, \omega)$  and  $u' = (h', \omega)$  are two recurrent configurations. Their  $\omega$ -addition is the relaxation of the configuration  $(h + h', \omega)$ .

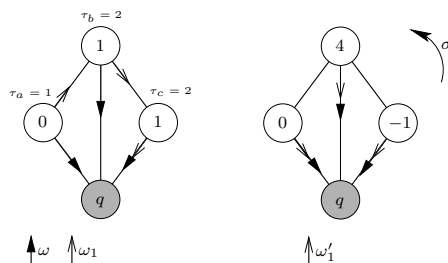

FIGURE 14.  $\omega$ -representation

DEFINITION 4.9. Let  $u, u'$  be two recurrent configurations of  $E_\omega$ . We define the  $\omega$ -addition  $u \oplus_\omega u'$  of the two configurations as the recurrent configuration sink-equivalent to the sum of the  $\omega$ -representation of  $u$  and  $u'$ .

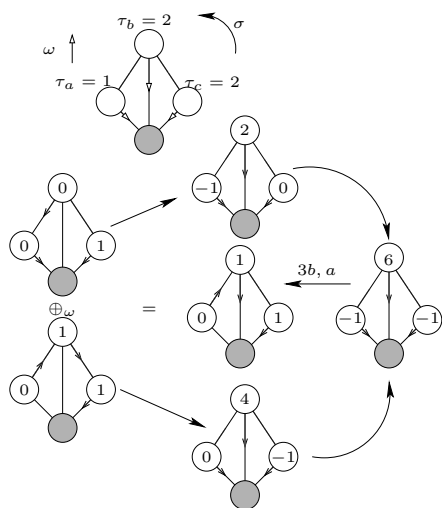

FIGURE 15. Example of addition

Note that this definition is coherent because there exists a unique recurrent configuration sink-equivalent to a configuration. For example, the identity of  $(E_\omega, \oplus_\omega)$  is the unique recurrent configuration sink-equivalent to  $(0, \omega)$  which can be obtained by the extended burning algorithm.

### 5. Conclusion

In this article we make an extensive study of the so-called Height Arrow Model. We show how the classical results of the Eulerian Walker and of the Abelian Sandpile Model could be generalized. Moreover, we find the cardinality of the set of recurrent configurations of the HAM but the proofs are analytic. It is possible to generalize the bijections between recurrent configurations and spanning trees as those found by Dhar.

### References

- [Big96] N. L. Biggs, *Chip-firing on distance-regular graphs*, Tech. Report LSE-CDAM-96-11, CDAM Research Report Series (1996).
- [Big99] ———, *Chip-firing and the critical group of a graph*, Journal of Algebraic Combinatorics **9** (1999), no. 1, 25–45.
- [BTW87] P. Bak, C. Tang, and K. Wiesenfeld, *Self-organized criticality: an explanation of  $1/f$  noise*, Phys. Rev. Lett. **59** (1987).
- [CGB02] S. Corteel and D. Gouyou-Beauchamps, *Enumeration of sand piles*, Discr. Math. **256** (2002), no. 3, 625–643.
- [CM92] R. Cori and A. Machi, *Maps, hypermaps and their automorphisms: a survey, i*, Expo. Math. **10** (1992), 403–427.
- [CR00] R. Cori and D. Rossin, *On the sandpile group of dual graphs*, European J. Combin. **21** (2000), no. 4, 447–459.
- [Dha90] D. Dhar, *Self-organized critical state of sandpile automaton models*, Physical Review Letters **64** (1990), 1613–1616.
- [DM91] D. Dhar and S. N. Majumdar, *Height correlations in the abelian sandpile model*, Journal of Physics A **24** (1991), 357–362.
- [DRSV95] D. Dhar, P. Ruelle, S. Sen, and D. Verma, *Algebraic aspects of abelian sandpile models*, Journal of Physics A **28** (1995), 805–831.
- [PDDK02] V B Priezzhev, D. Dhar, A Dhar, and S Krishnamurthy, *Eulerians walkers as a model of self-organized criticality*, Arxiv (2002).
- [WVL92] R.M. Wilson and J.H. Van Lindt, *A course in combinatorics*, Cambridge University Press, 1992, 449-460.

LIX, ECOLE POLYTECHNIQUE, ROUTE DE SACLAY, 91128 PALAISEAU CEDEX FRANCE  
*E-mail address:* `dartois@lix.polytechnique.fr`

LIAFA, UNIVERSITÉ PARIS 7, 2, PLACE JUSSIEU, CASE 7014, 75251 PARIS CEDEX  
*E-mail address:* `rossin@liafa.jussieu.fr`