



HAL
open science

Analysis of a Multiaxial Test on a C/C Composite by Using Digital Image Correlation and a Damage Model

Jean-Noël Périé, Sylvain Calloch, Christophe Cluzel, François Hild

► **To cite this version:**

Jean-Noël Périé, Sylvain Calloch, Christophe Cluzel, François Hild. Analysis of a Multiaxial Test on a C/C Composite by Using Digital Image Correlation and a Damage Model. *Experimental Mechanics*, 2002, 42 (3), pp.318-328. 10.1007/BF02410989 . hal-00013792

HAL Id: hal-00013792

<https://hal.science/hal-00013792>

Submitted on 17 Nov 2005

HAL is a multi-disciplinary open access archive for the deposit and dissemination of scientific research documents, whether they are published or not. The documents may come from teaching and research institutions in France or abroad, or from public or private research centers.

L'archive ouverte pluridisciplinaire **HAL**, est destinée au dépôt et à la diffusion de documents scientifiques de niveau recherche, publiés ou non, émanant des établissements d'enseignement et de recherche français ou étrangers, des laboratoires publics ou privés.

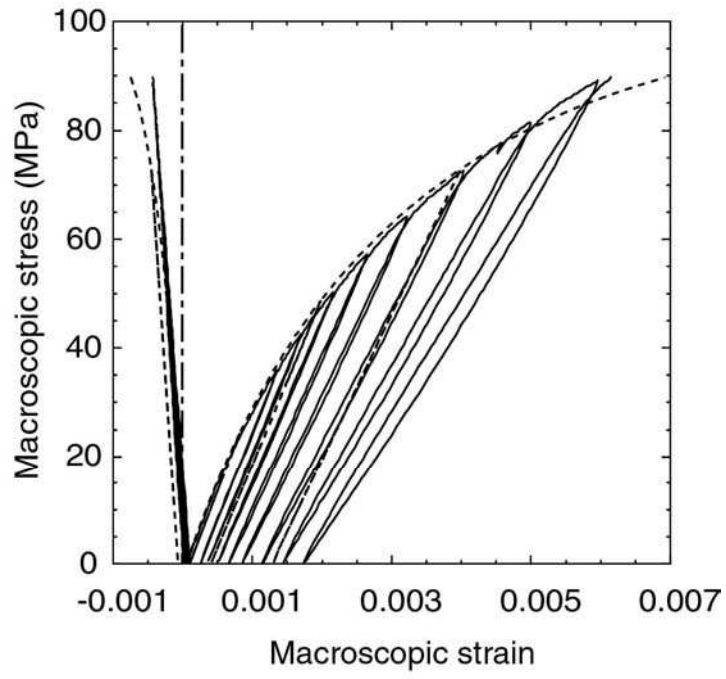

-a-

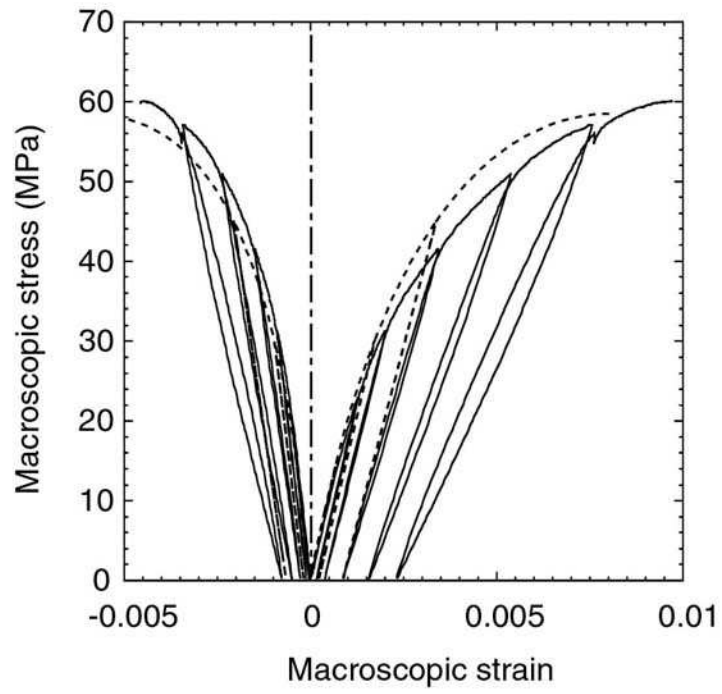

-b-

Figure 7



-a-

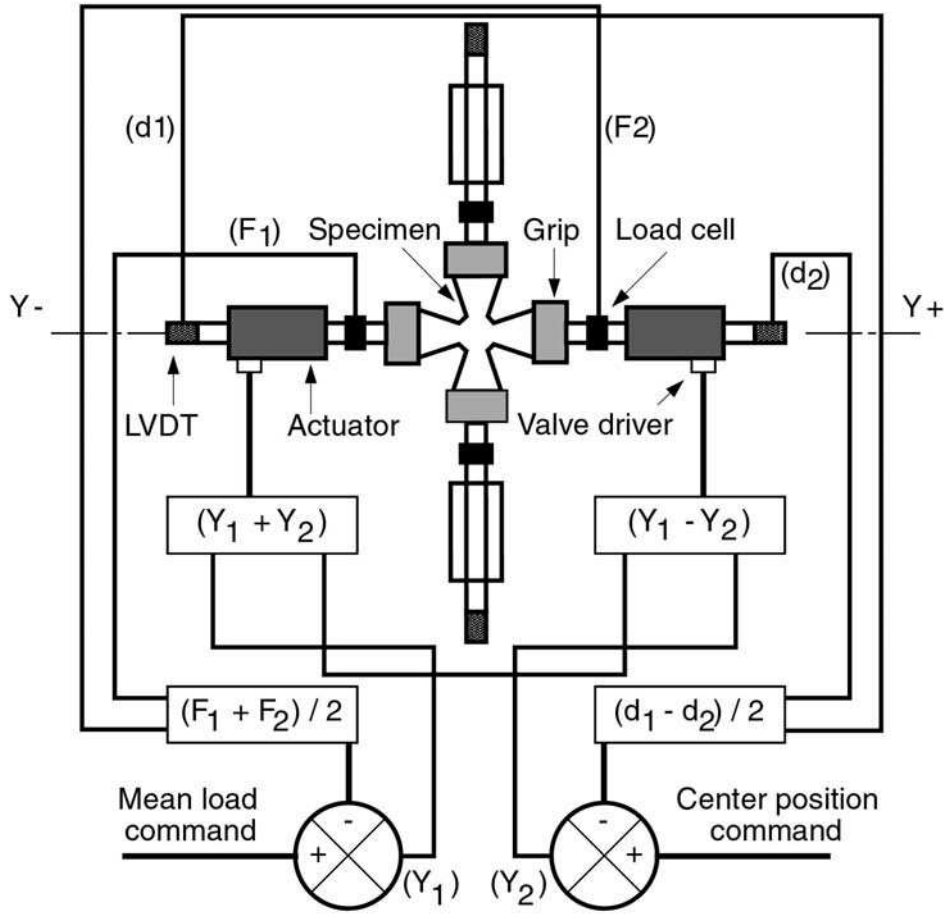

-b-

Figure 8

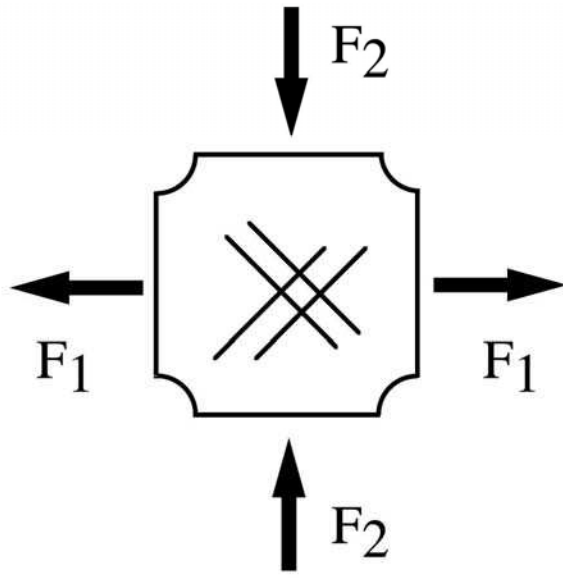

-a-

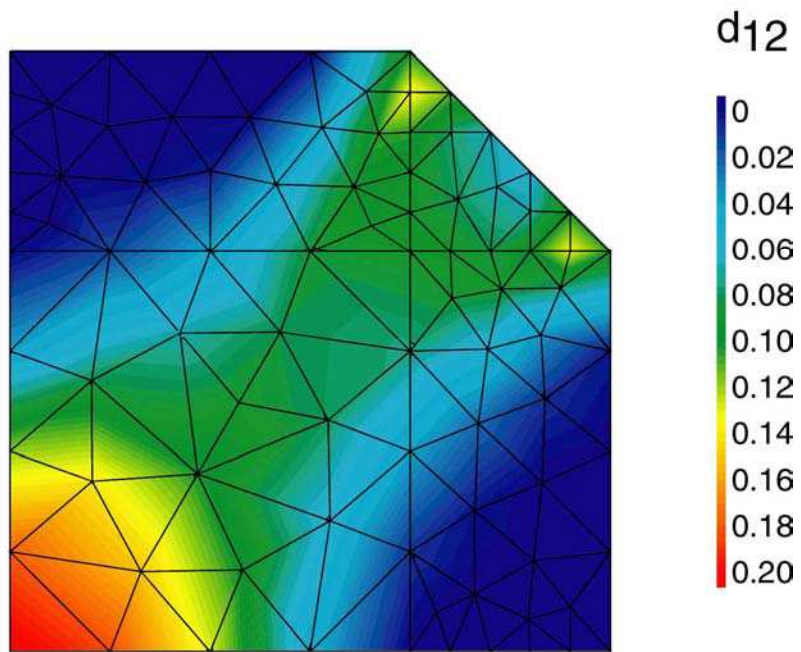

-b-

Figure 9

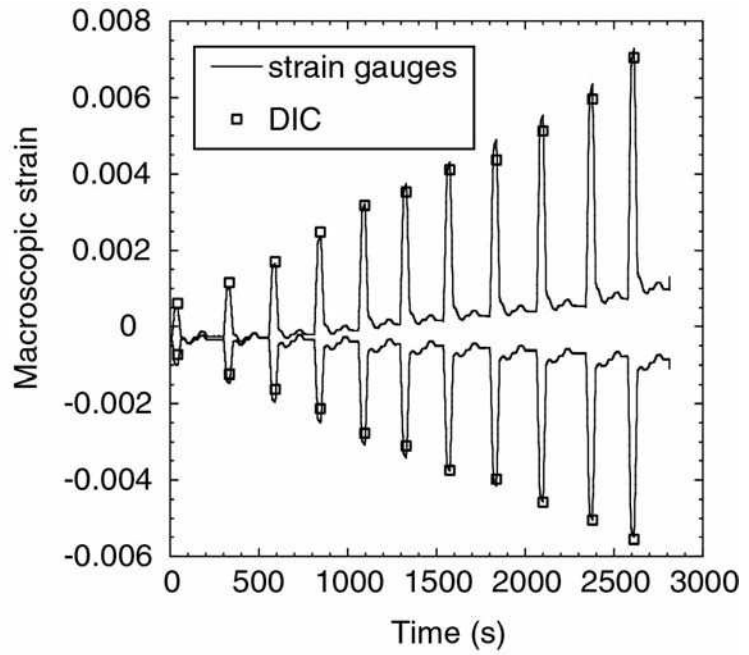
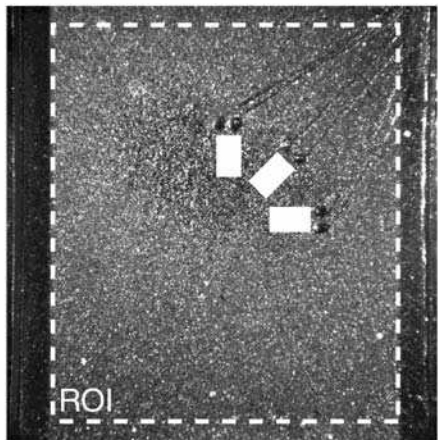

-a-

-b-

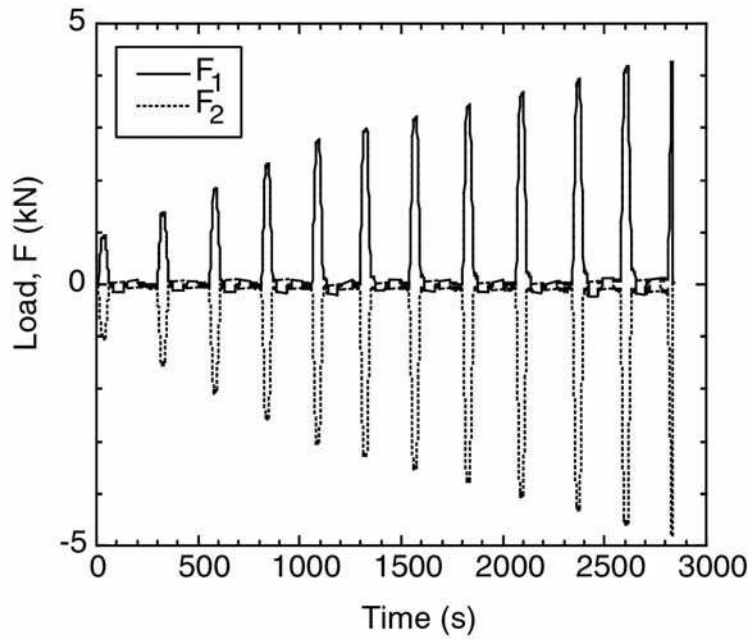

-c-

Figure 10

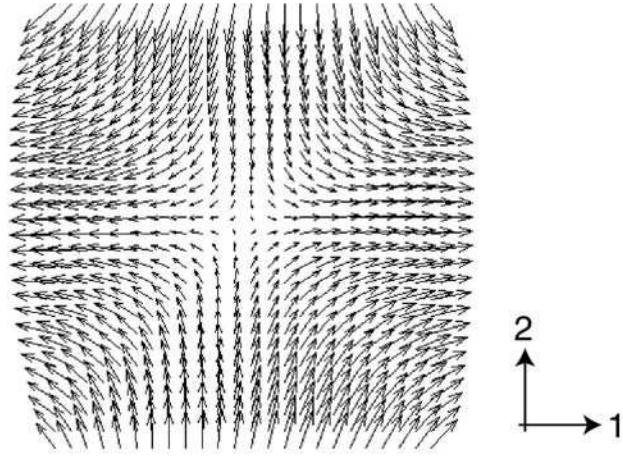

-a-

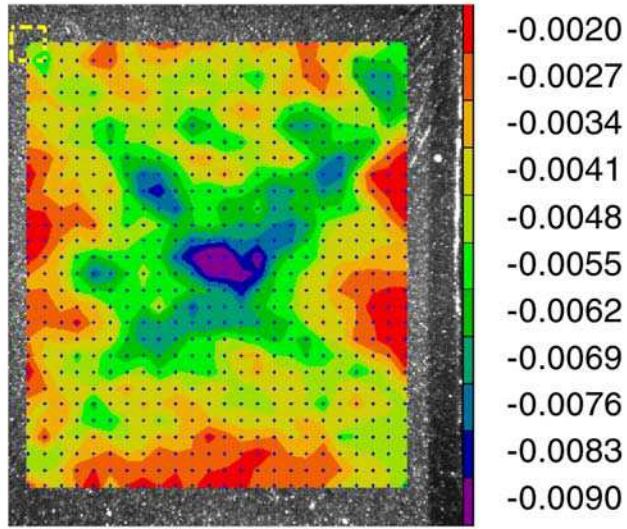

-b-

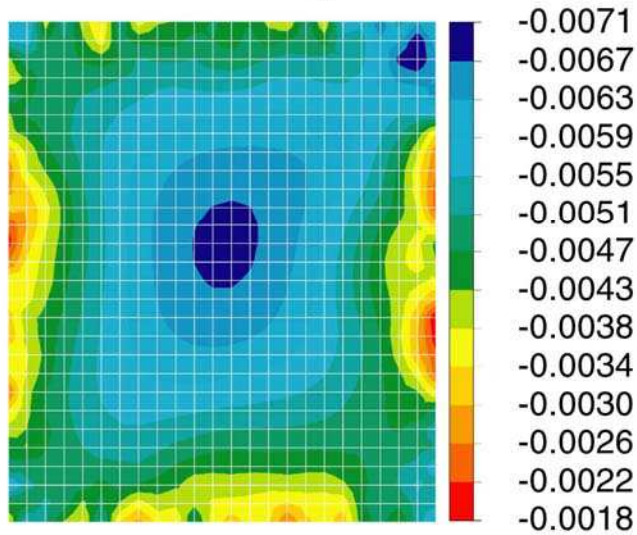

-c-

Figure 11

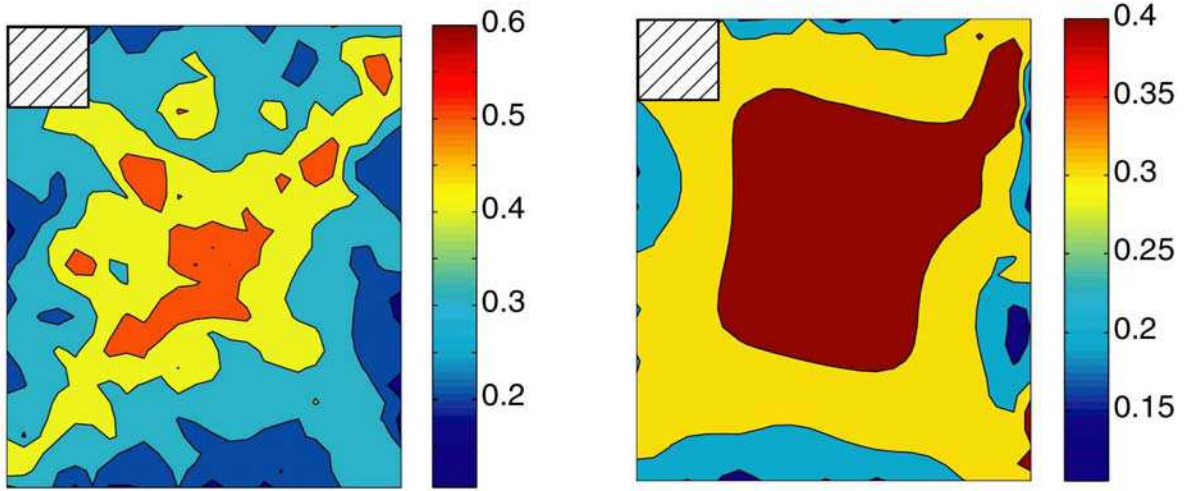
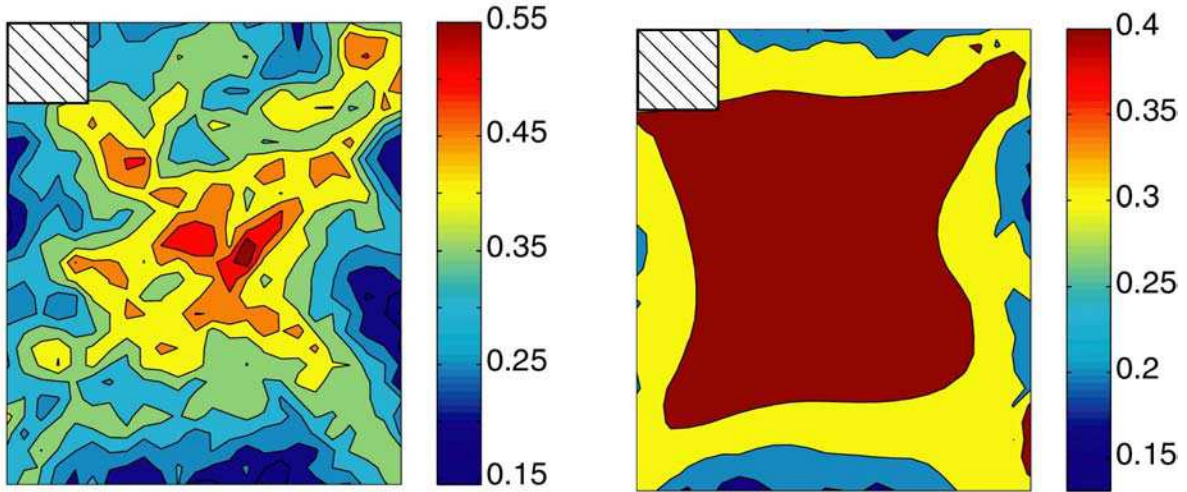

-a-

-b-

Figure 12

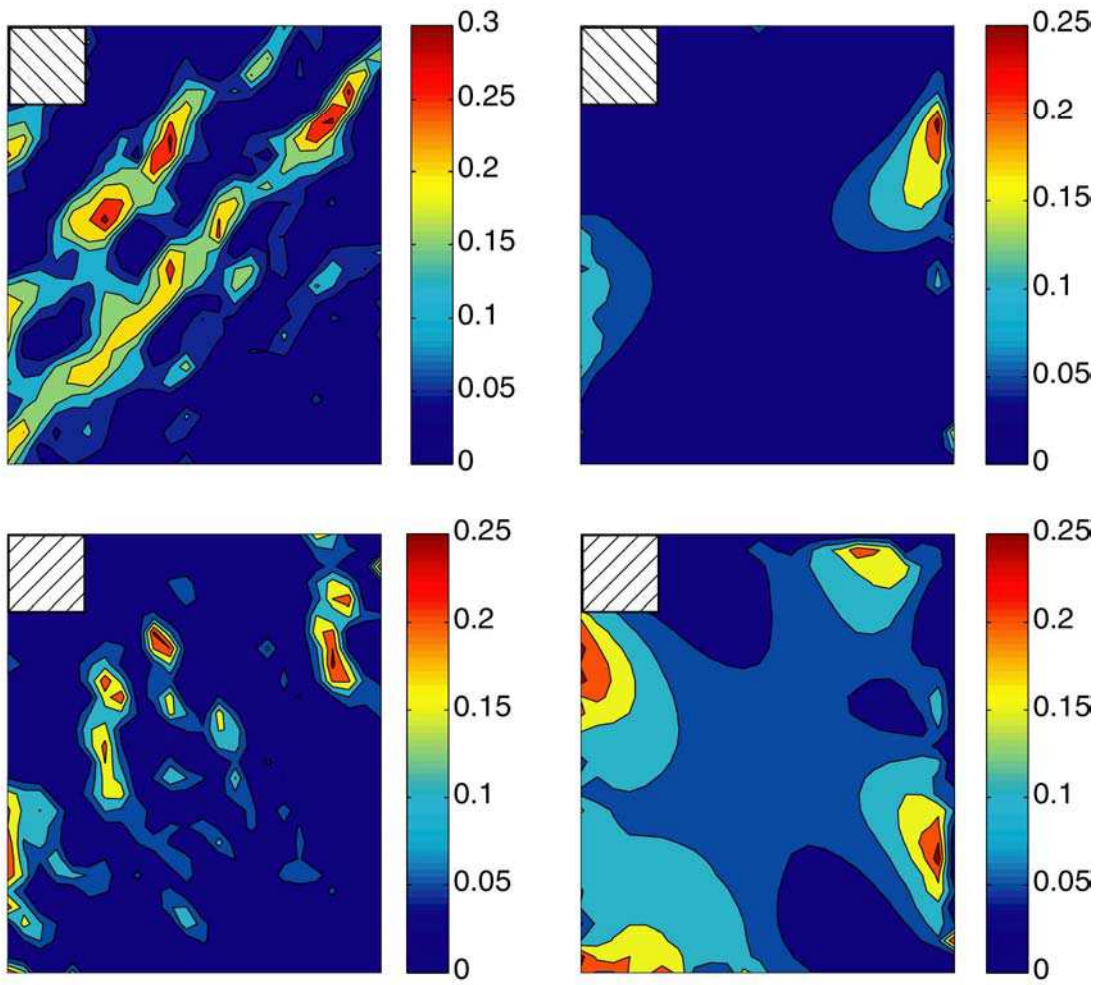

-a-

-b-

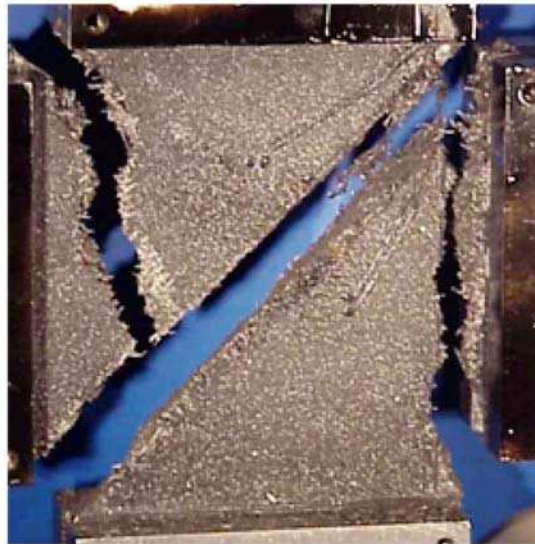

-c-

Figure 13

TABLE CAPTION

Table 1: Material parameters of the damage model at room temperature for a C/C composite.

Table 1

E_1^0	E_2^0	G_{12}^0	ν_{12}^0	b	Y_0	Y_c	Y_{01}	Y_{c1}
52 GPa	16.7 GPa	6.9 GPa	0.35	0.41	6.2 kPa	0.59 MPa	4.1 kPa	1.64 MPa

a_{11}	a_{12}	a_{22}	γ	β	R_0
1	1.5	1	0.52	1480	7 MPa
