



HAL
open science

Mathematical Theory of the Wigner-Weisskopf Atom

Vojkan Jaksic, Eugene Kritchevski, Claude-Alain Pillet

► **To cite this version:**

Vojkan Jaksic, Eugene Kritchevski, Claude-Alain Pillet. Mathematical Theory of the Wigner-Weisskopf Atom. J. Dereziński, H. Siedentop. Large Coulomb Systems, Springer/Lecture Notes in Physics 695, pp.145-215, 2006, Lecture Notes in Physics 695, <10.1007/b11607427>. <hal-00009011>

HAL Id: hal-00009011

<https://hal.science/hal-00009011v1>

Submitted on 30 Oct 2007

HAL is a multi-disciplinary open access archive for the deposit and dissemination of scientific research documents, whether they are published or not. The documents may come from teaching and research institutions in France or abroad, or from public or private research centers.

L'archive ouverte pluridisciplinaire HAL, est destinée au dépôt et à la diffusion de documents scientifiques de niveau recherche, publiés ou non, émanant des établissements d'enseignement et de recherche français ou étrangers, des laboratoires publics ou privés.



HAL Authorization

Mathematical Theory of the Wigner-Weisskopf Atom

V. Jakšić¹, E. Kritchevski¹, and C.-A. Pillet²

¹ Department of Mathematics and Statistics
McGill University
805 Sherbrooke Street West
Montreal, QC, H3A 2K6, Canada

² CPT-CNRS, UMR 6207
Université de Toulon, B.P. 20132
F-83957 La Garde Cedex, France

1	Introduction	2
2	Non-perturbative theory	4
2.1	Basic facts	6
2.2	Aronszajn-Donoghue theorem	9
2.3	The spectral theorem	10
2.4	Scattering theory	12
2.5	Spectral averaging	15
2.6	Simon-Wolff theorems	16
2.7	Fixing ω	16
2.8	Examples	20
2.9	Digression: the semi-circle law	24
3	The perturbative theory	25
3.1	The Radiating Wigner-Weisskopf atom	25
3.2	Perturbation theory of embedded eigenvalue	27
3.3	Complex deformations	31
3.4	Weak coupling limit	37
3.5	Examples	40
4	Fermionic quantization	46
4.1	Basic notions of fermionic quantization	46
4.2	Fermionic quantization of the WWA	47
4.3	Spectral theory	48
4.4	Scattering theory	49
5	Quantum statistical mechanics of the SEBB model	49
5.1	Quasi-free states	49
5.2	Non-equilibrium stationary states	50

5.3	Non-equilibrium thermodynamics	52
5.4	The effect of eigenvalues	55
5.5	Thermodynamics in the non-perturbative regime	58
5.6	Properties of the fluxes	59
5.7	Examples	61
	References	66

1 Introduction

In these lectures we shall study an "atom", \mathcal{S} , described by finitely many energy levels, coupled to a "radiation field", \mathcal{R} , described by another set (typically continuum) of energy levels. More precisely, assume that \mathcal{S} and \mathcal{R} are described, respectively, by the Hilbert spaces $\mathfrak{h}_{\mathcal{S}}$, $\mathfrak{h}_{\mathcal{R}}$ and the Hamiltonians $h_{\mathcal{S}}$, $h_{\mathcal{R}}$. Let $\mathfrak{h} = \mathfrak{h}_{\mathcal{S}} \oplus \mathfrak{h}_{\mathcal{R}}$ and $h_0 = h_{\mathcal{S}} \oplus h_{\mathcal{R}}$. If v is a self-adjoint operator on \mathfrak{h} describing the coupling between \mathcal{S} and \mathcal{R} , then the Hamiltonian we shall study is $h_{\lambda} \equiv h_0 + \lambda v$, where $\lambda \in \mathbb{R}$ is a coupling constant.

For reasons of space we shall restrict ourselves here to the case where \mathcal{S} is a single energy level, *i.e.*, we shall assume that $\mathfrak{h}_{\mathcal{S}} \equiv \mathbb{C}$ and that $h_{\mathcal{S}} \equiv \omega$ is the operator of multiplication by a real number ω . The multilevel case will be considered in the continuation of these lecture notes [JP3]. We will keep $\mathfrak{h}_{\mathcal{R}}$ and $h_{\mathcal{R}}$ general and we will assume that the interaction has the form $v = w + w^*$, where $w : \mathbb{C} \rightarrow \mathfrak{h}_{\mathcal{R}}$ is a linear map.

With a slight abuse of notation, in the sequel we will drop \oplus whenever the meaning is clear within the context. Hence, we will write α for $\alpha \oplus 0$, g for $0 \oplus g$, *etc.* If $w(1) = f$, then $w = (1|\cdot)f$ and $v = (1|\cdot)f + (f|\cdot)1$.

In physics literature, a Hamiltonian of the form

$$h_{\lambda} = h_0 + \lambda((1|\cdot)f + (f|\cdot)1), \quad (1)$$

with $\lambda \in \mathbb{R}$ is sometimes called *Wigner-Weisskopf atom* (abbreviated WWA) and we will adopt that name. Operators of the type (1) are also often called *Friedrichs Hamiltonians* [Fr]. The WWA is a toy model invented to illuminate various aspects of quantum physics; see [AJPP1, AM, Ar, BR2, CDG, Da1, Da4, DK, Fr, FGP, He, Maa, Mes, PSS].

Our study of the WWA naturally splits into several parts. Non-perturbative and perturbative spectral analysis are discussed respectively in Sections 2 and 3. The fermionic second quantization of WWA is discussed in Sections 4 and 5.

In Section 2 we place no restrictions on $h_{\mathcal{R}}$ and we obtain qualitative information on the spectrum of h_{λ} which is valid either for all or for Lebesgue a.e. $\lambda \in \mathbb{R}$. Our analysis is based on the spectral theory of rank one perturbations [Ja, Si1]. The theory discussed in this section naturally applies to the cases where \mathcal{R} describes a quasi-periodic or a random structure, or the coupling constant λ is large.

Quantitative information about the WWA can be obtained only in the perturbative regime and under suitable regularity assumptions. In Section 3.2 we assume that the

spectrum of $h_{\mathcal{R}}$ is purely absolutely continuous, and we study spectral properties of h_{λ} for small, non-zero λ . The main subject of Section 3.2 is the perturbation theory of embedded eigenvalues and related topics (complex resonances, radiative life-time, spectral deformations, weak coupling limit). Although the material covered in this section is very well known, our exposition is not traditional and we hope that the reader will learn something new. The reader may benefit by reading this section in parallel with Complement C_{III} in [CDG].

The second quantizations of the WWA lead to the simplest non-trivial examples of open systems in quantum statistical mechanics. We shall call the fermionic second quantization of the WWA the *Simple Electronic Black Box* (SEBB) model. The SEBB model in the perturbative regime has been studied in the recent lecture notes [AJPP1]. In Sections 4 and 5 we extend the analysis and results of [AJPP1] to the non-perturbative regime. For additional information about the Electronic Black Box models we refer the reader to [AJPP2].

Assume that $\mathfrak{h}_{\mathcal{R}}$ is a *real* Hilbert space and consider the WWA (1) over the real Hilbert space $\mathbb{R} \oplus \mathfrak{h}_{\mathcal{R}}$. The bosonic second quantization of the wave equation $\partial_t^2 \psi_t + h_{\lambda} \psi_t = 0$ (see Section 6.3 in [BSZ] and the lectures [DeB, Der1] in this volume) leads to the so called *FC (fully coupled) quantum oscillator model*. This model has been extensively discussed in the literature. The well-known references in the mathematics literature are [Ar, Da1, FKM]. For references in the physics literature the reader may consult [Br, LW]. One may use the results of these lecture notes to completely describe spectral theory, scattering theory, and statistical mechanics of the FC quantum oscillator model. For reasons of space we shall not discuss this topic here (see [JP3]).

These lecture notes are on a somewhat higher technical level than the recent lecture notes of the first and the third author [AJPP1, Ja, Pi]. The first two sections can be read as a continuation (i.e. the final section) of the lecture notes [Ja]. In these two sections we have assumed that the reader is familiar with elementary aspects of spectral theory and harmonic analysis discussed in [Ja]. Alternatively, all the prerequisites can be found in [Ka, Koo, RS1, RS2, RS3, RS4, Ru]. In Section 2 we have assumed that the reader is familiar with basic results of the rank one perturbation theory [Ja, Si1]. In Sections 4 and 5 we have assumed that the reader is familiar with basic notions of quantum statistical mechanics [BR1, BR2, BSZ, Ha]. The reader with no previous exposure to open quantum systems would benefit by reading the last two sections in parallel with [AJPP1].

The notation used in these notes is standard except that we denote the spectrum of a self-adjoint operator A by $\text{sp}(A)$. The set of eigenvalues, the absolutely continuous, the pure point and the singular continuous spectrum of A are denoted respectively by $\text{sp}_p(A)$, $\text{sp}_{ac}(A)$, $\text{sp}_{pp}(A)$, and $\text{sp}_{sc}(A)$. The singular spectrum of A is $\text{sp}_{\text{sing}}(A) = \text{sp}_{pp}(A) \cup \text{sp}_{sc}(A)$. The spectral subspaces associated to the absolutely continuous, the pure point, and the singular continuous spectrum of A are denoted by $\mathfrak{h}_{ac}(A)$, $\mathfrak{h}_{pp}(A)$, and $\mathfrak{h}_{sc}(A)$. The projections on these spectral subspaces are denoted by $\mathbf{1}_{ac}(A)$, $\mathbf{1}_{pp}(A)$, and $\mathbf{1}_{sc}(A)$.

Acknowledgment. These notes are based on the lectures the first author gave in the Summer School "Large Coulomb Systems—QED", held in Nordfjordeid, August

11—18 2003. V.J. is grateful to Jan Dereziński and Heinz Siedentop for the invitation to speak and for their hospitality. The research of V.J. was partly supported by NSERC. The research of E.K. was supported by an FCAR scholarship. We are grateful to S. De Bièvre and J. Dereziński for enlightening remarks on an earlier version of these lecture notes.

2 Non-perturbative theory

Let ν be a positive Borel measure on \mathbb{R} . We denote by ν_{ac} , ν_{pp} , and ν_{sc} the absolutely continuous, the pure point and the singular continuous part of ν w.r.t. the Lebesgue measure. The singular part of ν is $\nu_{sing} = \nu_{pp} + \nu_{sc}$. We adopt the definition of a complex Borel measure given in [Ja, Ru]. In particular, any complex Borel measure on \mathbb{R} is finite.

Let ν be a complex Borel measure or a positive measure such that

$$\int_{\mathbb{R}} \frac{d\nu(t)}{1 + |t|} < \infty.$$

The Borel transform of ν is the analytic function

$$F_{\nu}(z) \equiv \int_{\mathbb{R}} \frac{d\nu(t)}{t - z}, \quad z \in \mathbb{C} \setminus \mathbb{R}.$$

Let ν be a complex Borel measure or a positive measure such that

$$\int_{\mathbb{R}} \frac{d\nu(t)}{1 + t^2} < \infty. \quad (2)$$

The Poisson transform of ν is the harmonic function

$$P_{\nu}(x, y) \equiv y \int_{\mathbb{R}} \frac{d\nu(t)}{(x - t)^2 + y^2}, \quad x + iy \in \mathbb{C}_+,$$

where $\mathbb{C}_{\pm} \equiv \{z \in \mathbb{C} \mid \pm \operatorname{Im} z > 0\}$.

The Borel transform of a positive Borel measure is a Herglotz function, *i.e.*, an analytic function on \mathbb{C}_+ with positive imaginary part. In this case

$$P_{\nu}(x, y) = \operatorname{Im} F_{\nu}(x + iy),$$

is a positive harmonic function. The G -function of ν is defined by

$$G_{\nu}(x) \equiv \int_{\mathbb{R}} \frac{d\nu(t)}{(x - t)^2} = \lim_{y \downarrow 0} \frac{P_{\nu}(x, y)}{y}, \quad x \in \mathbb{R}.$$

We remark that G_{ν} is an everywhere defined function on \mathbb{R} with values in $[0, \infty]$. Note also that if $G_{\nu}(x) < \infty$, then $\lim_{y \downarrow 0} \operatorname{Im} F_{\nu}(x + iy) = 0$.

If $h(z)$ is analytic in the half-plane \mathbb{C}_{\pm} , we set

$$h(x \pm i0) \equiv \lim_{y \downarrow 0} h(x \pm iy),$$

whenever the limit exist. In these lecture notes we will use a number of standard results concerning the boundary values $F_\nu(x \pm i0)$. The proofs of these results can be found in [Ja] or in any book on harmonic analysis. We note in particular that $F_\nu(x \pm i0)$ exist and is finite for Lebesgue a.e. $x \in \mathbb{R}$. If ν is real-valued and non-vanishing, then for any $a \in \mathbb{C}$ the sets $\{x \in \mathbb{R} \mid F_\nu(x \pm i0) = a\}$ have zero Lebesgue measure.

Let ν be a positive Borel measure. For later reference, we describe some elementary properties of its Borel transform. First, the Cauchy-Schwartz inequality yields that for $y > 0$

$$\nu(\mathbb{R}) \operatorname{Im} F_\nu(x + iy) \geq y |F_\nu(x + iy)|^2. \quad (3)$$

The dominated convergence theorem yields

$$\lim_{y \rightarrow \infty} y \operatorname{Im} F_\nu(iy) = \lim_{y \rightarrow \infty} y |F_\nu(iy)| = \nu(\mathbb{R}). \quad (4)$$

Assume in addition that $\nu(\mathbb{R}) = 1$. The monotone convergence theorem yields

$$\begin{aligned} & \lim_{y \rightarrow \infty} y^2 (y \operatorname{Im} F_\nu(iy) - y^2 |F_\nu(iy)|^2) \\ &= \lim_{y \rightarrow \infty} \frac{y^4}{2} \int_{\mathbb{R} \times \mathbb{R}} \left(\frac{1}{t^2 + y^2} + \frac{1}{s^2 + y^2} - \frac{2}{(t - iy)(s + iy)} \right) d\nu(t) d\nu(s) \\ &= \lim_{y \rightarrow \infty} \frac{1}{2} \int_{\mathbb{R} \times \mathbb{R}} \frac{y^2}{t^2 + y^2} \frac{y^2}{s^2 + y^2} (t - s)^2 d\nu(t) d\nu(s) \\ &= \frac{1}{2} \int_{\mathbb{R} \times \mathbb{R}} (t - s)^2 d\nu(t) d\nu(s). \end{aligned}$$

If ν has finite second moment, $\int_{\mathbb{R}} t^2 d\nu(t) < \infty$, then

$$\frac{1}{2} \int_{\mathbb{R} \times \mathbb{R}} (t - s)^2 d\nu(t) d\nu(s) = \int_{\mathbb{R}} t^2 d\nu(t) - \left(\int_{\mathbb{R}} t d\nu(t) \right)^2. \quad (5)$$

If $\int_{\mathbb{R}} t^2 d\nu(t) = \infty$, then it is easy to see that the both sides in (5) are also infinite. Combining this with Equ. (4) we obtain

$$\lim_{y \rightarrow \infty} \frac{y \operatorname{Im} F_\nu(iy) - y^2 |F_\nu(iy)|^2}{|F_\nu(iy)|^2} = \int_{\mathbb{R}} t^2 d\nu(t) - \left(\int_{\mathbb{R}} t d\nu(t) \right)^2, \quad (6)$$

where the right hand side is defined to be ∞ whenever $\int_{\mathbb{R}} t^2 d\nu(t) = \infty$.

In the sequel $|B|$ denotes the Lebesgue measure of a Borel set B and δ_y the delta-measure at $y \in \mathbb{R}$.

2.1 Basic facts

Let $\mathfrak{h}_{\mathcal{R},f} \subset \mathfrak{h}_{\mathcal{R}}$ be the cyclic space generated by $h_{\mathcal{R}}$ and f . We recall that $\mathfrak{h}_{\mathcal{R},f}$ is the closure of the linear span of the set of vectors $\{(h_{\mathcal{R}} - z)^{-1}f \mid z \in \mathbb{C} \setminus \mathbb{R}\}$. Since $(\mathbb{C} \oplus \mathfrak{h}_{\mathcal{R},f})^\perp$ is invariant under h_λ for all λ and

$$h_\lambda|_{(\mathbb{C} \oplus \mathfrak{h}_{\mathcal{R},f})^\perp} = h_{\mathcal{R}}|_{(\mathbb{C} \oplus \mathfrak{h}_{\mathcal{R},f})^\perp},$$

in this section without loss of generality we may assume that $\mathfrak{h}_{\mathcal{R},f} = \mathfrak{h}_{\mathcal{R}}$, namely that f is a cyclic vector for $h_{\mathcal{R}}$. We denote by $\mu_{\mathcal{R}}$ the spectral measure for $h_{\mathcal{R}}$ and f . By the spectral theorem, w.l.o.g. we may assume that

$$\mathfrak{h}_{\mathcal{R}} = L^2(\mathbb{R}, d\mu_{\mathcal{R}}),$$

that $h_{\mathcal{R}} \equiv x$ is the operator of multiplication by the variable x , and that $f(x) = 1$ for all $x \in \mathbb{R}$. We will write $F_{\mathcal{R}}$ for $F_{\mu_{\mathcal{R}}}$, etc.

As we shall see, in the non-perturbative theory of the WWA it is very natural to consider the Hamiltonian (1) as an operator-valued function of two real parameters λ and ω . Hence, in this section we will write

$$h_{\lambda,\omega} \equiv h_0 + \lambda v = \omega \oplus x + \lambda((f|\cdot)1 + (1|\cdot)f).$$

We start with some basic formulas. The relation

$$A^{-1} - B^{-1} = A^{-1}(B - A)B^{-1},$$

yields that

$$\begin{aligned} (h_{\lambda,\omega} - z)^{-1}1 &= (\omega - z)^{-1}1 - \lambda(\omega - z)^{-1}(h_{\lambda,\omega} - z)^{-1}f, \\ (h_{\lambda,\omega} - z)^{-1}f &= (h_{\mathcal{R}} - z)^{-1}f - \lambda(f|(h_{\mathcal{R}} - z)^{-1}f)(h_{\lambda,\omega} - z)^{-1}1. \end{aligned} \quad (7)$$

It follows that the cyclic subspace generated by $h_{\lambda,\omega}$ and the vectors $1, f$, is independent of λ and equal to \mathfrak{h} , and that for $\lambda \neq 0$, 1 is a cyclic vector for $h_{\lambda,\omega}$. We denote by $\mu^{\lambda,\omega}$ the spectral measure for $h_{\lambda,\omega}$ and 1 . The measure $\mu^{\lambda,\omega}$ contains full spectral information about $h_{\lambda,\omega}$ for $\lambda \neq 0$. We also denote by $F_{\lambda,\omega}$ and $G_{\lambda,\omega}$ the Borel transform and the G -function of $\mu^{\lambda,\omega}$. The formulas (7) yield

$$F_{\lambda,\omega}(z) = \frac{1}{\omega - z - \lambda^2 F_{\mathcal{R}}(z)}. \quad (8)$$

Since $F_{\lambda,\omega} = F_{-\lambda,\omega}$, the operators $h_{\lambda,\omega}$ and $h_{-\lambda,\omega}$ are unitarily equivalent.

According to the decomposition $\mathfrak{h} = \mathfrak{h}_S \oplus \mathfrak{h}_{\mathcal{R}}$ we can write the resolvent $r_{\lambda,\omega}(z) \equiv (h_{\lambda,\omega} - z)^{-1}$ in matrix form

$$r_{\lambda,\omega}(z) = \begin{bmatrix} r_{\lambda,\omega}^{SS}(z) & r_{\lambda,\omega}^{S\mathcal{R}}(z) \\ r_{\lambda,\omega}^{\mathcal{R}S}(z) & r_{\lambda,\omega}^{\mathcal{R}\mathcal{R}}(z) \end{bmatrix}.$$

A simple calculation leads to the following formulas for its matrix elements

$$\begin{aligned}
 r_{\lambda,\omega}^{\mathcal{S}\mathcal{S}}(z) &= F_{\lambda,\omega}(z), \\
 r_{\lambda,\omega}^{\mathcal{S}\mathcal{R}}(z) &= -\lambda F_{\lambda,\omega}(z)1(f|(h_{\mathcal{R}} - z)^{-1} \cdot), \\
 r_{\lambda,\omega}^{\mathcal{R}\mathcal{S}}(z) &= -\lambda F_{\lambda,\omega}(z)(h_{\mathcal{R}} - z)^{-1}f(1|\cdot), \\
 r_{\lambda,\omega}^{\mathcal{R}\mathcal{R}}(z) &= (h_{\mathcal{R}} - z)^{-1} + \lambda^2 F_{\lambda,\omega}(z)(h_{\mathcal{R}} - z)^{-1}f(f|(h_{\mathcal{R}} - z)^{-1} \cdot).
 \end{aligned} \tag{9}$$

Note that for $\lambda \neq 0$,

$$F_{\lambda,\omega}(z) = \frac{F_{\lambda,0}(z)}{1 + \omega F_{\lambda,0}(z)}.$$

This formula should not come as a surprise. For fixed $\lambda \neq 0$,

$$h_{\lambda,\omega} = h_{\lambda,0} + \omega(1|\cdot)1,$$

and since 1 is a cyclic vector for $h_{\lambda,\omega}$, we are in the usual framework of the rank one perturbation theory with ω as the perturbation parameter! This observation will allow us to naturally embed the spectral theory of $h_{\lambda,\omega}$ into the spectral theory of rank one perturbations.

By taking the imaginary part of Relation (8) we can relate the G -functions of $\mu_{\mathcal{R}}$ and $\mu^{\lambda,\omega}$ as

$$G_{\lambda,\omega}(x) = \frac{1 + \lambda^2 G_{\mathcal{R}}(x)}{|\omega - x - \lambda^2 F_{\mathcal{R}}(x + i0)|^2}, \tag{10}$$

whenever the boundary value $F_{\mathcal{R}}(x + i0)$ exists and the numerator and denominator of the right hand side are not both infinite.

It is important to note that, subject to a natural restriction, every rank one spectral problem can be put into the form $h_{\lambda,\omega}$ for a fixed $\lambda \neq 0$.

Proposition 1. *Let ν be a Borel probability measure on \mathbb{R} and $\lambda \neq 0$. Then the following statements are equivalent:*

1. *There exists a Borel probability measure $\mu_{\mathcal{R}}$ on \mathbb{R} such that the corresponding $\mu^{\lambda,0}$ is equal to ν .*
2. *$\int_{\mathbb{R}} t d\nu(t) = 0$ and $\int_{\mathbb{R}} t^2 d\nu(t) = \lambda^2$.*

Proof. (1) \Rightarrow (2) Assume that $\mu_{\mathcal{R}}$ exists. Then $h_{\lambda,0}1 = \lambda f$ and hence

$$\int_{\mathbb{R}} t d\nu(t) = (1, h_{\lambda,0}1) = 0,$$

and

$$\int_{\mathbb{R}} t^2 d\nu(t) = \|h_{\lambda,0}1\|^2 = \lambda^2.$$

(2) \Rightarrow (1) We need to find a probability measure $\mu_{\mathcal{R}}$ such that

$$F_{\mathcal{R}}(z) = \lambda^{-2} \left(-z - \frac{1}{F_{\nu}(z)} \right), \tag{11}$$

for all $z \in \mathbb{C}_+$. Set

$$H_\nu(z) \equiv -z - \frac{1}{F_\nu(z)}.$$

Equ. (3) yields that $\mathbb{C}_+ \ni z \mapsto \lambda^{-2} \operatorname{Im} H_\nu(z)$ is a non-negative harmonic function. Hence, by well-known results in harmonic analysis (see e.g. [Ja, Koo]), there exists a Borel measure $\mu_{\mathcal{R}}$ which satisfies (2) and a constant $C \geq 0$ such that

$$\lambda^{-2} \operatorname{Im} H_\nu(x + iy) = P_{\mathcal{R}}(x, y) + Cy, \quad (12)$$

for all $x + iy \in \mathbb{C}_+$. The dominated convergence theorem and (2) yield that

$$\lim_{y \rightarrow \infty} \frac{P_{\mathcal{R}}(0, y)}{y} = \lim_{y \rightarrow \infty} \int_{\mathbb{R}} \frac{d\mu_{\mathcal{R}}(t)}{t^2 + y^2} = 0.$$

Note that

$$y \operatorname{Im} H_\nu(iy) = \frac{y \operatorname{Im} F_\nu(iy) - y^2 |F_\nu(iy)|^2}{|F_\nu(iy)|^2}, \quad (13)$$

and so Equ. (6) yields

$$\lim_{y \rightarrow \infty} \frac{\operatorname{Im} H_\nu(iy)}{y} = 0.$$

Hence, (12) yields that $C = 0$ and that

$$F_{\mathcal{R}}(z) = \lambda^{-2} H_\nu(z) + C_1, \quad (14)$$

where C_1 is a real constant. From Equ. (4), (13) and (6) we get

$$\begin{aligned} \mu_{\mathcal{R}}(\mathbb{R}) &= \lim_{y \rightarrow \infty} y \operatorname{Im} F_{\mathcal{R}}(iy) \\ &= \lambda^{-2} \lim_{y \rightarrow \infty} y \operatorname{Im} H_\nu(iy) \\ &= \lambda^{-2} \left(\int_{\mathbb{R}} t^2 d\nu(t) - \left(\int_{\mathbb{R}} t d\nu(t) \right)^2 \right) = 1, \end{aligned}$$

and so $\mu_{\mathcal{R}}$ is probability measure. Since

$$\operatorname{Re} H_\nu(iy) = -\frac{\operatorname{Re} F_\nu(iy)}{|F_\nu(iy)|^2},$$

Equ. (14), (4) and the dominated convergence theorem yield that

$$\begin{aligned} \lambda^2 C_1 &= -\lim_{y \rightarrow \infty} \operatorname{Re} H_\nu(iy) \\ &= -\lim_{y \rightarrow \infty} y^2 \operatorname{Re} F_\nu(iy) \\ &= -\lim_{y \rightarrow \infty} \int_{\mathbb{R}} \frac{ty^2}{t^2 + y^2} d\nu(t) \\ &= -\int_{\mathbb{R}} t d\nu(t) = 0. \end{aligned}$$

Hence, $C_1 = 0$ and Equ. (11) holds. \square

2.2 Aronszajn-Donoghue theorem

For $\lambda \neq 0$ define

$$\begin{aligned} T_{\lambda,\omega} &\equiv \{x \in \mathbb{R} \mid G_{\mathcal{R}}(x) < \infty, x - \omega + \lambda^2 F_{\mathcal{R}}(x + i0) = 0\}, \\ S_{\lambda,\omega} &\equiv \{x \in \mathbb{R} \mid G_{\mathcal{R}}(x) = \infty, x - \omega + \lambda^2 F_{\mathcal{R}}(x + i0) = 0\}, \\ L &\equiv \{x \in \mathbb{R} \mid \operatorname{Im} F_{\mathcal{R}}(x + i0) > 0\}. \end{aligned} \quad (15)$$

Since the analytic function $\mathbb{C}_+ \ni z \mapsto z - \omega + \lambda^2 F_{\mathcal{R}}(z)$ is non-constant and has a positive imaginary part, by a well known result in harmonic analysis $|T_{\lambda,\omega}| = |S_{\lambda,\omega}| = 0$. Equ. (8) implies that, for $\omega \neq 0$, $x - \omega + \lambda^2 F_{\mathcal{R}}(x + i0) = 0$ is equivalent to $F_{\lambda,0}(x + i0) = -\omega^{-1}$. Moreover, if one of these conditions is satisfied, then Equ. (10) yields

$$\omega^2 G_{\lambda,0}(x) = 1 + \lambda^2 G_{\mathcal{R}}(x).$$

Therefore, if $\omega \neq 0$, then

$$\begin{aligned} T_{\lambda,\omega} &= \{x \in \mathbb{R} \mid G_{\lambda,0}(x) < \infty, F_{\lambda,0}(x + i0) = -\omega^{-1}\}, \\ S_{\lambda,\omega} &= \{x \in \mathbb{R} \mid G_{\lambda,0}(x) = \infty, F_{\lambda,0}(x + i0) = -\omega^{-1}\}. \end{aligned}$$

The well-known Aronszajn-Donoghue theorem in spectral theory of rank one perturbations (see [Ja, Si1]) translates to the following result concerning the WWA.

Theorem 1. *1. $T_{\lambda,\omega}$ is the set of eigenvalues of $h_{\lambda,\omega}$. Moreover,*

$$\mu_{\text{PP}}^{\lambda,\omega} = \sum_{x \in T_{\lambda,\omega}} \frac{1}{1 + \lambda^2 G_{\mathcal{R}}(x)} \delta_x. \quad (16)$$

If $\omega \neq 0$, then also

$$\mu_{\text{PP}}^{\lambda,\omega} = \sum_{x \in T_{\lambda,\omega}} \frac{1}{\omega^2 G_{\lambda,0}(x)} \delta_x.$$

2. ω is not an eigenvalue of $h_{\lambda,\omega}$ for all $\lambda \neq 0$.
3. $\mu_{\text{sc}}^{\lambda,\omega}$ is concentrated on $S_{\lambda,\omega}$.
4. For all λ, ω , the set L is an essential support of the absolutely continuous spectrum of $h_{\lambda,\omega}$. Moreover $\operatorname{sp}_{\text{ac}}(h_{\lambda,\omega}) = \operatorname{sp}_{\text{ac}}(h_{\mathcal{R}})$ and

$$d\mu_{\text{ac}}^{\lambda,\omega}(x) = \frac{1}{\pi} \operatorname{Im} F_{\lambda,\omega}(x + i0) dx.$$

5. For a given ω , $\{\mu_{\text{sing}}^{\lambda,\omega} \mid \lambda > 0\}$ is a family of mutually singular measures.
6. For a given $\lambda \neq 0$, $\{\mu_{\text{sing}}^{\lambda,\omega} \mid \omega \neq 0\}$ is a family of mutually singular measures.

2.3 The spectral theorem

In this subsection $\lambda \neq 0$ and ω are given real numbers. By the spectral theorem, there exists a unique unitary operator

$$U^{\lambda,\omega} : \mathfrak{h} \rightarrow L^2(\mathbb{R}, d\mu^{\lambda,\omega}), \quad (17)$$

such that $U^{\lambda,\omega} h_{\lambda,\omega} (U^{\lambda,\omega})^{-1}$ is the operator of multiplication by x on the Hilbert space $L^2(\mathbb{R}, d\mu^{\lambda,\omega})$ and $U^{\lambda,\omega} 1 = \mathbb{1}$, where $\mathbb{1}(x) = 1$ for all $x \in \mathbb{R}$. Moreover,

$$U^{\lambda,\omega} = U_{\text{ac}}^{\lambda,\omega} \oplus U_{\text{pp}}^{\lambda,\omega} \oplus U_{\text{sc}}^{\lambda,\omega},$$

where

$$U_{\text{ac}}^{\lambda,\omega} : \mathfrak{h}_{\text{ac}}(h_{\lambda,\omega}) \rightarrow L^2(\mathbb{R}, d\mu_{\text{ac}}^{\lambda,\omega}),$$

$$U_{\text{pp}}^{\lambda,\omega} : \mathfrak{h}_{\text{pp}}(h_{\lambda,\omega}) \rightarrow L^2(\mathbb{R}, d\mu_{\text{pp}}^{\lambda,\omega}),$$

$$U_{\text{sc}}^{\lambda,\omega} : \mathfrak{h}_{\text{sc}}(h_{\lambda,\omega}) \rightarrow L^2(\mathbb{R}, d\mu_{\text{sc}}^{\lambda,\omega}),$$

are unitary. In this subsection we will describe these unitary operators. We shall make repeated use of the following fact. Let μ be a positive Borel measure on \mathbb{R} . For any complex Borel measure ν on \mathbb{R} denote by $\nu = \nu_{\text{ac}} + \nu_{\text{sing}}$ the Lebesgue decomposition of ν into absolutely continuous and singular parts w.r.t. μ . The Radon-Nikodym derivative of ν_{ac} w.r.t. μ is given by

$$\lim_{y \downarrow 0} \frac{P_\nu(x, y)}{P_\mu(x, y)} = \frac{d\nu_{\text{ac}}}{d\mu}(x),$$

for μ -almost every x (see [Ja]). In particular, if μ is Lebesgue measure, then

$$\lim_{y \downarrow 0} P_\nu(x, y) = \pi \frac{d\nu_{\text{ac}}}{dx}(x), \quad (18)$$

for Lebesgue a.e. x . By Equ. (8),

$$\text{Im } F_{\lambda,\omega}(x + i0) = \lambda^2 |F_{\lambda,\omega}(x + i0)|^2 \text{Im } F_{\mathcal{R}}(x + i0), \quad (19)$$

and so (18) yields that

$$\frac{d\mu_{\text{ac}}^{\lambda,\omega}}{dx} = \lambda^2 |F_{\lambda,\omega}(x + i0)|^2 \frac{d\mu_{\mathcal{R},\text{ac}}}{dx}.$$

In particular, since $F_{\lambda,\omega}(x + i0) \neq 0$ for Lebesgue a.e. x , $\mu_{\mathcal{R},\text{ac}}$ and $\mu_{\text{ac}}^{\lambda,\omega}$ are equivalent measures.

Let $\phi = \alpha \oplus \varphi \in \mathfrak{h}$ and

$$M(z) \equiv \frac{1}{2i} \left[(1|(h_{\lambda,\omega} - z)^{-1}\phi) - (1|(h_{\lambda,\omega} - \bar{z})^{-1}\phi) \right], \quad z \in \mathbb{C}_+.$$

The formulas (7) and (9) yield that

$$(1|(h_{\lambda,\omega} - z)^{-1}\phi) = F_{\lambda,\omega}(z) \left(\alpha - \lambda(f|(h_{\mathcal{R}} - z)^{-1}\varphi) \right), \quad (20)$$

and so

$$\begin{aligned} M(z) &= \operatorname{Im} F_{\lambda,\omega}(z) \left(\alpha - \lambda(f|(h_{\mathcal{R}} - z)^{-1}\varphi) \right) \\ &\quad - \lambda F_{\lambda,\omega}(\bar{z}) \left(y(f|((h_{\mathcal{R}} - x)^2 + y^2)^{-1}\varphi) \right) \\ &= \operatorname{Im} F_{\lambda,\omega}(z) \left(\alpha - \lambda(f|(h_{\mathcal{R}} - z)^{-1}\varphi) \right) \\ &\quad - \lambda F_{\lambda,\omega}(\bar{z}) y \int_{\mathbb{R}} \frac{\overline{f(t)}\varphi(t)}{(t-x)^2 + y^2} d\mu_{\mathcal{R}}(t). \end{aligned}$$

This relation and (18) yield that for $\mu_{\mathcal{R},ac}$ -a.e. x ,

$$\begin{aligned} M(x+i0) &= \operatorname{Im} F_{\lambda,\omega}(x+i0) \left(\alpha - \lambda(f|(h_{\mathcal{R}} - x - i0)^{-1}\varphi) \right) \\ &\quad - \lambda F_{\lambda,\omega}(x-i0) \overline{f(x)}\varphi(x) \pi \frac{d\mu_{\mathcal{R},ac}}{dx}(x) \\ &= \operatorname{Im} F_{\lambda,\omega}(x+i0) \left(\alpha - \lambda(f|(h_{\mathcal{R}} - x - i0)^{-1}\varphi) \right) \\ &\quad - \lambda F_{\lambda,\omega}(x-i0) \overline{f(x)}\varphi(x) \operatorname{Im} F_{\mathcal{R}}(x+i0). \end{aligned} \quad (21)$$

On the other hand, computing $M(z)$ in the spectral representation (17) we get

$$M(z) = y \int_{\mathbb{R}} \frac{(U^{\lambda,\omega}\phi)(t)}{(t-x)^2 + y^2} d\mu^{\lambda,\omega}(t).$$

This relation and (18) yield that for $\mu_{ac}^{\lambda,\omega}$ -a.e. x ,

$$M(x+i0) = (U_{ac}^{\lambda,\omega}\phi)(x) \pi \frac{d\mu_{ac}^{\lambda,\omega}}{dx}(x) = (U_{ac}^{\lambda,\omega}\phi)(x) \operatorname{Im} F_{\lambda,\omega}(x+i0).$$

Since $\mu_{\mathcal{R},ac}$ and $\mu_{ac}^{\lambda,\omega}$ are equivalent measures, comparison with the expression (21) and use of Equ. (8) yield

Proposition 2. *Let $\phi = \alpha \oplus \varphi \in \mathfrak{h}$. Then*

$$(U_{ac}^{\lambda,\omega}\phi)(x) = \alpha - \lambda(f|(h_{\mathcal{R}} - x - i0)^{-1}\varphi) - \frac{\overline{f(x)}\varphi(x)}{\lambda F_{\lambda,\omega}(x+i0)}.$$

We now turn to the pure point part $U_{pp}^{\lambda,\omega}$. Recall that $T_{\lambda,\omega}$ is the set of eigenvalues of $h_{\lambda,\omega}$. Using the spectral representation (17), it is easy to prove that for $x \in T_{\lambda,\omega}$

$$\lim_{y \downarrow 0} \frac{(1|(h_{\lambda,\omega} - x - iy)^{-1}\phi)}{(1|(h_{\lambda,\omega} - x - iy)^{-1}1)} = \lim_{y \downarrow 0} \frac{F_{(U^{\lambda,\omega}\phi)\mu^{\lambda,\omega}}(x+iy)}{F_{\lambda,\omega}(x+iy)} = (U^{\lambda,\omega}\phi)(x). \quad (22)$$

The relations (20) and (22) yield that for $x \in T_{\lambda,\omega}$ the limit

$$H_\varphi(x + i0) \equiv \lim_{y \downarrow 0} (f|(h_{\mathcal{R}} - x - iy)^{-1}\varphi), \quad (23)$$

exists and that $(U^{\lambda,\omega}\phi)(x) = \alpha - \lambda H_\varphi(x + i0)$. Hence, we have:

Proposition 3. *Let $\phi = \alpha \oplus \varphi \in \mathfrak{h}$. Then for $x \in T_{\lambda,\omega}$,*

$$(U_{\text{pp}}^{\lambda,\omega}\phi)(x) = \alpha - \lambda H_\varphi(x + i0).$$

The assumption $x \in T_{\lambda,\omega}$ makes the proof of (22) easy. However, this formula holds in a much stronger form. It is a deep result of Poltoratskii [Po] (see also [Ja, JL]) that

$$\lim_{y \downarrow 0} \frac{(1|(h_{\lambda,\omega} - x - iy)^{-1}\phi)}{(1|(h_{\lambda,\omega} - x - iy)^{-1}1)} = (U^{\lambda,\omega}\phi)(x) \quad \text{for } \mu_{\text{sing}}^{\lambda,\omega} \text{ - a.e. } x. \quad (24)$$

Hence, the limit (23) exists and is finite for $\mu_{\text{sing}}^{\lambda,\omega}$ -a.e. x . Thus, we have:

Proposition 4. *Let $\phi = \alpha \oplus \varphi \in \mathfrak{h}$. Then,*

$$(U_{\text{sing}}^{\lambda,\omega}\phi)(x) = \alpha - \lambda H_\varphi(x + i0),$$

where $U_{\text{sing}}^{\lambda,\omega} = U_{\text{pp}}^{\lambda,\omega} \oplus U_{\text{sc}}^{\lambda,\omega}$.

2.4 Scattering theory

Recall that $h_{\mathcal{R}}$ is the operator of multiplication by the variable x on the space $L^2(\mathbb{R}, d\mu_{\mathcal{R}})$. $U^{\lambda,\omega}h_{\lambda,\omega}(U^{\lambda,\omega})^{-1}$ is the operator of multiplication by x on the space $L^2(\mathbb{R}, d\mu^{\lambda,\omega})$. Set

$$h_{\mathcal{R},\text{ac}} \equiv h_{\mathcal{R}}|_{\mathfrak{h}_{\text{ac}}(h_{\mathcal{R}})}, \quad h_{\lambda,\omega,\text{ac}} \equiv h_{\lambda,\omega}|_{\mathfrak{h}_{\text{ac}}(h_{\lambda,\omega})}.$$

Since $\mathfrak{h}_{\text{ac}}(h_{\mathcal{R}}) = L^2(\mathbb{R}, d\mu_{\mathcal{R},\text{ac}})$,

$$\mathfrak{h}_{\text{ac}}(h_{\lambda,\omega}) = (U_{\text{ac}}^{\lambda,\omega})^{-1}L^2(\mathbb{R}, d\mu_{\text{ac}}^{\lambda,\omega}),$$

and the measures $\mu_{\mathcal{R},\text{ac}}$ and $\mu_{\text{ac}}^{\lambda,\omega}$ are equivalent, the operators $h_{\mathcal{R},\text{ac}}$ and $h_{\lambda,\omega,\text{ac}}$ are unitarily equivalent. Using (18) and the chain rule one easily checks that the operator

$$(W^{\lambda,\omega}\phi)(x) = \sqrt{\frac{d\mu_{\text{ac}}^{\lambda,\omega}}{d\mu_{\mathcal{R},\text{ac}}}}(x) (U_{\text{ac}}^{\lambda,\omega}\phi)(x) = \sqrt{\frac{\text{Im } F_{\lambda,\omega}(x + i0)}{\text{Im } F_{\mathcal{R}}(x + i0)}} (U_{\text{ac}}^{\lambda,\omega}\phi)(x),$$

is an explicit unitary which takes $\mathfrak{h}_{\text{ac}}(h_{\lambda,\omega})$ onto $\mathfrak{h}_{\text{ac}}(h_{\mathcal{R}})$ and satisfies

$$W^{\lambda,\omega}h_{\lambda,\omega,\text{ac}} = h_{\mathcal{R},\text{ac}}W^{\lambda,\omega}.$$

There are however many unitaries $U : \mathfrak{h}_{\text{ac}}(h_{\lambda,\omega}) \rightarrow \mathfrak{h}_{\text{ac}}(h_{\mathcal{R}})$ with the intertwining property

$$U h_{\lambda,\omega,\text{ac}} = h_{\mathcal{R},\text{ac}} U. \quad (25)$$

Indeed, let $\varphi \in \mathfrak{h}_{\text{ac}}(h_{\mathcal{R}})$ be a normalized cyclic vector for $h_{\mathcal{R},\text{ac}}$. Then there is a unique unitary U such that (25) holds and

$$U \mathbf{1}_{\text{ac}}(h_{\lambda,\omega}) \mathbf{1} = c\varphi,$$

where $c = \|\mathbf{1}_{\text{ac}}(h_{\lambda,\omega}) \mathbf{1}\|$ is a normalization constant. On the other hand, any unitary with the property (25) is uniquely specified by its action on the vector $\mathbf{1}_{\text{ac}}(h_{\lambda,\omega}) \mathbf{1}$. Note that

$$(W^{\lambda,\omega} \mathbf{1}_{\text{ac}}(h_{\lambda}) \mathbf{1})(x) = \sqrt{\frac{\text{Im } F_{\lambda,\omega}(x+i0)}{\text{Im } F_{\mathcal{R}}(x+i0)}}.$$

In this subsection we describe a particular pair of unitaries, called wave operators, which satisfy (25).

Theorem 2. *1. The strong limits*

$$U_{\lambda,\omega}^{\pm} \equiv \text{s-}\lim_{t \rightarrow \pm\infty} e^{ith_{\lambda,\omega}} e^{-it h_0} \mathbf{1}_{\text{ac}}(h_0), \quad (26)$$

exist and $\text{Ran } U_{\lambda,\omega}^{\pm} = \mathfrak{h}_{\text{ac}}(h_{\lambda,\omega})$.

2. The strong limits

$$\Omega_{\lambda,\omega}^{\pm} \equiv \text{s-}\lim_{t \rightarrow \pm\infty} e^{it h_0} e^{-it h_{\lambda,\omega}} \mathbf{1}_{\text{ac}}(h_{\lambda,\omega}), \quad (27)$$

exist and $\text{Ran } \Omega_{\lambda,\omega}^{\pm} = \mathfrak{h}_{\text{ac}}(h_0)$.

3. The maps $U_{\lambda,\omega}^{\pm} : \mathfrak{h}_{\text{ac}}(h_0) \rightarrow \mathfrak{h}_{\text{ac}}(h_{\lambda,\omega})$ and $\Omega_{\lambda,\omega}^{\pm} : \mathfrak{h}_{\text{ac}}(h_{\lambda,\omega}) \rightarrow \mathfrak{h}_{\text{ac}}(h_0)$ are unitary. $U_{\lambda,\omega}^{\pm} \Omega_{\lambda,\omega}^{\pm} = \mathbf{1}_{\text{ac}}(h_{\lambda,\omega})$ and $\Omega_{\lambda,\omega}^{\pm} U_{\lambda,\omega}^{\pm} = \mathbf{1}_{\text{ac}}(h_0)$. Moreover, $\Omega_{\lambda,\omega}^{\pm}$ satisfies the intertwining relation (25).

4. The S -matrix $S \equiv \Omega_{\lambda,\omega}^+ U_{\lambda,\omega}^-$ is unitary on $\mathfrak{h}_{\text{ac}}(h_0)$ and commutes with $h_{0,\text{ac}}$.

This theorem is a basic result in scattering theory. The detailed proof can be found in [Ka, RS3].

The wave operators and the S -matrix can be described as follows.

Proposition 5. *Let $\phi = \alpha \oplus \varphi \in \mathfrak{h}$. Then*

$$(\Omega_{\lambda,\omega}^{\pm} \phi)(x) = \varphi(x) - \lambda f(x) F_{\lambda,\omega}(x \pm i0) (\alpha - \lambda(f|(h_{\mathcal{R}} - x \mp i0)^{-1} \varphi)). \quad (28)$$

Moreover, for any $\psi \in \mathfrak{h}_{\text{ac}}(h_0)$ one has $(S\psi)(x) = S(x)\psi(x)$ with

$$S(x) = 1 + 2\pi i \lambda^2 F_{\lambda,\omega}(x+i0) |f(x)|^2 \frac{d\mu_{\mathcal{R},\text{ac}}}{dx}(x). \quad (29)$$

Remark. The assumption that f is a cyclic vector for $h_{\mathcal{R}}$ is not needed in Theorem 2 and Proposition 5.

Proof. We deal only with $\Omega_{\lambda,\omega}^+$. The case of $\Omega_{\lambda,\omega}^-$ is completely similar. The formula for $U_{\lambda,\omega}^\pm$ follows from the formula for $\Omega_{\lambda,\omega}^\pm$ by duality (use Theorem 2). Given these formulas, it is easy to compute the S -matrix.

Let $\psi \in \mathfrak{h}_{\text{ac}}(h_0) = \mathfrak{h}_{\text{ac}}(h_{\mathcal{R}})$. We start with the identity

$$(\psi|e^{ith_0}e^{-ith_{\lambda,\omega}}\phi) = (\psi|\phi) - i\lambda \int_0^t (\psi|e^{ish_0}f)(1|e^{-ish_{\lambda,\omega}}\phi) ds. \quad (30)$$

Note that $(\psi|\phi) = (\psi|\varphi)$, $(\psi|e^{ish_0}f) = (\psi|e^{ish_{\mathcal{R}}}f)$, and that

$$\begin{aligned} \lim_{t \rightarrow \infty} (\psi|e^{ith_0}e^{-ith_{\lambda,\omega}}\phi) &= \lim_{t \rightarrow \infty} (e^{ith_{\lambda,\omega}}e^{-ith_0}\psi|\phi) \\ &= (U_{\lambda,\omega}^+\psi|\phi) \\ &= (\psi|\Omega_{\lambda,\omega}^+\phi). \end{aligned}$$

Hence, by the Abel theorem,

$$(\psi|\Omega_{\lambda,\omega}^+\phi) = (\psi|\varphi) - \lim_{y \downarrow 0} i\lambda L(y), \quad (31)$$

where

$$L(y) = \int_0^\infty e^{-ys} (\psi|e^{ish_0}f)(1|e^{-ish_{\lambda,\omega}}\phi) ds.$$

Now,

$$\begin{aligned} L(y) &= \int_0^\infty e^{-ys} (\psi|e^{ish_0}f)(1|e^{-ish_{\lambda,\omega}}\phi) ds \\ &= \int_{\mathbb{R}} \overline{\psi(x)} f(x) \left[\int_0^\infty (1|e^{is(x+iy-h_{\lambda,\omega})}\phi) ds \right] d\mu_{\mathcal{R},\text{ac}}(x) \\ &= -i \int_{\mathbb{R}} \overline{\psi(x)} f(x) (1|(h_{\lambda,\omega} - x - iy)^{-1}\phi) d\mu_{\mathcal{R},\text{ac}}(x) \\ &= -i \int_{\mathbb{R}} \overline{\psi(x)} f(x) g_y(x) d\mu_{\mathcal{R},\text{ac}}(x), \end{aligned} \quad (32)$$

where

$$g_y(x) \equiv (1|(h_{\lambda,\omega} - x - iy)^{-1}\phi).$$

Recall that for Lebesgue a.e. x ,

$$g_y(x) \rightarrow g(x) \equiv (1|(h_{\lambda,\omega} - x - i0)^{-1}\phi), \quad (33)$$

as $y \downarrow 0$. By the Egoroff theorem (see e.g. Problem 16 in Chapter 3 of [Ru], or any book on measure theory), for any $n > 0$ there exists a measurable set $R_n \subset \mathbb{R}$ such that $|\mathbb{R} \setminus R_n| < 1/n$ and $g_y \rightarrow g$ uniformly on R_n . The set

$$\bigcup_{n>0} \{\psi \in L^2(\mathbb{R}, d\mu_{\mathcal{R},\text{ac}}) \mid \text{supp } \psi \subset R_n\},$$

is clearly dense in $\mathfrak{h}_{\text{ac}}(h_{\mathcal{R}})$. For any ψ in this set the uniform convergence $g_y \rightarrow g$ on $\text{supp } \psi$ implies that there exists a constant C_ψ such that

$$|\overline{\psi} f(g_y - g)| \leq C_\psi |\overline{\psi} f| \in L^1(\mathbb{R}, d\mu_{\mathcal{R}, \text{ac}}).$$

This estimate and the dominated convergence theorem yield that

$$\lim_{y \downarrow 0} \int_{\mathbb{R}} \overline{\psi} f(g_y - g) d\mu_{\mathcal{R}, \text{ac}} = 0.$$

On the other hand, Equ. (31) and (32) yield that the limit

$$\lim_{y \downarrow 0} \int_{\mathbb{R}} \overline{\psi} f g_y d\mu_{\mathcal{R}},$$

exists, and so the relation

$$(\psi | \Omega_{\lambda, \omega}^+ \phi) = (\psi | \varphi) - \lambda \int_{\mathbb{R}} \overline{\psi(x)} f(x) (1 | (h_{\lambda, \omega} - x - i0)^{-1} \phi) d\mu_{\mathcal{R}, \text{ac}}(x),$$

holds for a dense set of vectors ψ . Hence,

$$(\Omega_{\lambda, \omega}^+ \phi)(x) = \varphi(x) - \lambda f(x) (1 | (h_{\lambda, \omega} - x - i0)^{-1} \phi),$$

and the formula (20) completes the proof. \square

2.5 Spectral averaging

We will freely use the standard measurability results concerning the measure-valued function $(\lambda, \omega) \mapsto \mu^{\lambda, \omega}$. The reader not familiar with these facts may consult [CFKS, CL, Ja].

Let $\lambda \neq 0$ and

$$\overline{\mu}^\lambda(B) = \int_{\mathbb{R}} \mu^{\lambda, \omega}(B) d\omega,$$

where $B \subset \mathbb{R}$ is a Borel set. Obviously, $\overline{\mu}^\lambda$ is a Borel measure on \mathbb{R} . The following (somewhat surprising) result is often called *spectral averaging*.

Proposition 6. *The measure $\overline{\mu}^\lambda$ is equal to the Lebesgue measure and for all $g \in L^1(\mathbb{R}, dx)$,*

$$\int_{\mathbb{R}} g(x) dx = \int_{\mathbb{R}} \left[\int_{\mathbb{R}} g(x) d\mu^{\lambda, \omega}(x) \right] d\omega.$$

The proof of this proposition is elementary and can be found in [Ja, Si1].

One can also average with respect to both parameters. It follows from Proposition 6 that the averaged measure

$$\overline{\mu}(B) = \frac{1}{\pi} \int_{\mathbb{R}^2} \frac{\mu^{\lambda, \omega}(B)}{1 + \lambda^2} d\lambda d\omega,$$

is also equal to the Lebesgue measure.

2.6 Simon-Wolff theorems

Recall that $x + \lambda^2 F_{\mathcal{R}}(x + i0)$ and $F_{\lambda,0}(x + i0)$ are finite and non-vanishing for Lebesgue a.e. x . For $\lambda \neq 0$, Equ. (10) gives that for Lebesgue a.e. x ,

$$G_{\lambda,0}(x) = \frac{1 + \lambda^2 G_{\mathcal{R}}(x)}{|x + \lambda^2 F_{\mathcal{R}}(x + i0)|^2} = |F_{\lambda,0}(x + i0)|^2 (1 + \lambda^2 G_{\mathcal{R}}(x)).$$

These observations yield:

Lemma 1. *Let $B \subset \mathbb{R}$ be a Borel set and $\lambda \neq 0$. Then $G_{\mathcal{R}}(x) < \infty$ for Lebesgue a.e. $x \in B$ iff $G_{\lambda,0}(x) < \infty$ for Lebesgue a.e. $x \in B$.*

This lemma and the Simon-Wolff theorems in rank one perturbation theory (see [Ja, Si1, SW]) yield:

Theorem 3. *Let $B \subset \mathbb{R}$ be a Borel set. Then the following statements are equivalent:*

1. $G_{\mathcal{R}}(x) < \infty$ for Lebesgue a.e. $x \in B$.
2. For all $\lambda \neq 0$, $\mu_{\text{cont}}^{\lambda,\omega}(B) = 0$ for Lebesgue a.e. $\omega \in \mathbb{R}$. In particular, $\mu_{\text{cont}}^{\lambda,\omega}(B) = 0$ for Lebesgue a.e. $(\lambda, \omega) \in \mathbb{R}^2$.

Theorem 4. *Let $B \subset \mathbb{R}$ be a Borel set. Then the following statements are equivalent:*

1. $\text{Im } F_{\mathcal{R}}(x + i0) = 0$ and $G_{\mathcal{R}}(x) = \infty$ for Lebesgue a.e. $x \in B$.
2. For all $\lambda \neq 0$, $\mu_{\text{ac}}^{\lambda,\omega}(B) + \mu_{\text{pp}}^{\lambda,\omega}(B) = 0$ for Lebesgue a.e. $\omega \in \mathbb{R}$. In particular, $\mu_{\text{ac}}^{\lambda,\omega}(B) + \mu_{\text{pp}}^{\lambda,\omega}(B) = 0$ for Lebesgue a.e. $(\lambda, \omega) \in \mathbb{R}^2$.

Theorem 5. *Let $B \subset \mathbb{R}$ be a Borel set. Then the following statements are equivalent:*

1. $\text{Im } F_{\mathcal{R}}(x + i0) > 0$ for Lebesgue a.e. $x \in B$.
2. For all $\lambda \neq 0$, $\mu_{\text{sing}}^{\lambda,\omega}(B) = 0$ for Lebesgue a.e. $\omega \in \mathbb{R}$. In particular, $\mu_{\text{sing}}^{\lambda,\omega}(B) = 0$ for Lebesgue a.e. $(\lambda, \omega) \in \mathbb{R}^2$.

Note that while the Simon-Wolff theorems hold for a fixed λ and for a.e. ω , we cannot claim that they hold for a fixed ω and for a.e. λ —from Fubini's theorem we can deduce only that for a.e. ω the results hold for a.e. λ . This is somewhat annoying since in many applications for physical reasons it is natural to fix ω and vary λ . The next subsection deals with this issue.

2.7 Fixing ω

The results discussed in this subsection are not an immediate consequence of the standard results of rank one perturbation theory and for this reason we will provide complete proofs.

In this subsection ω is a fixed real number. Let

$$\bar{\mu}^{\omega}(B) = \int_{\mathbb{R}} \mu^{\lambda,\omega}(B) d\lambda,$$

where $B \subset \mathbb{R}$ is a Borel set. Obviously, $\bar{\mu}^\omega$ is a positive Borel measure on \mathbb{R} and for all Borel measurable $g \geq 0$,

$$\int_{\mathbb{R}} g(t) d\bar{\mu}^\omega(t) = \int_{\mathbb{R}} \left[\int_{\mathbb{R}} g(t) d\mu^{\lambda, \omega}(t) \right] d\lambda,$$

where both sides are allowed to be infinite.

We will study the measure $\bar{\mu}^\omega$ by examining the boundary behavior of its Poisson transform $P_\omega(x, y)$ as $y \downarrow 0$. In this subsection we set

$$h(z) \equiv (\omega - z)F_{\mathcal{R}}(z).$$

Lemma 2. For $z \in \mathbb{C}_+$,

$$P_\omega(z) = \frac{\pi}{\sqrt{2}} \frac{\sqrt{|h(z)| + \operatorname{Re} h(z)}}{|h(z)|}.$$

Proof. We start with

$$\begin{aligned} P_\omega(x, y) &= \int_{\mathbb{R}} \left[\int_{\mathbb{R}} \frac{y}{(t-x)^2 + y^2} d\mu^{\lambda, \omega}(t) \right] d\lambda \\ &= \operatorname{Im} \int_{\mathbb{R}} F_{\lambda, \omega}(x + iy) d\lambda. \end{aligned}$$

Equ. (8) and a simple residue calculation yield

$$\int_{\mathbb{R}} F_{\lambda, \omega}(x + iy) d\lambda = \frac{-\pi i}{F_{\mathcal{R}}(z) \sqrt{\frac{\omega - z}{F_{\mathcal{R}}(z)}}},$$

where the branch of the square root is chosen to be in \mathbb{C}_+ . An elementary calculation shows that

$$P_\omega(x, y) = \operatorname{Im} \frac{i\pi}{\sqrt{h(x + iy)}},$$

where the branch of the square root is chosen to have positive real part, explicitly

$$\sqrt{w} \equiv \frac{1}{\sqrt{2}} \left(\sqrt{|w| + \operatorname{Re} w} + i \operatorname{sign}(\operatorname{Im} w) \sqrt{|w| - \operatorname{Re} w} \right). \quad (34)$$

This yields the statement. \square

Theorem 6. The measure $\bar{\mu}^\omega$ is absolutely continuous with respect to Lebesgue measure and

$$\frac{d\bar{\mu}^\omega}{dx}(x) = \frac{\sqrt{|h(x + i0)| + \operatorname{Re} h(x + i0)}}{\sqrt{2} |h(x + i0)|}. \quad (35)$$

The set

$$\mathcal{E} \equiv \{x \mid \operatorname{Im} F_{\mathcal{R}}(x + i0) > 0\} \cup \{x \mid (\omega - x)F_{\mathcal{R}}(x + i0) > 0\},$$

is an essential support for $\bar{\mu}^\omega$ and $\mu^{\lambda, \omega}$ is concentrated on \mathcal{E} for all $\lambda \neq 0$.

Proof. By Theorem 1, ω is not an eigenvalue of $h^{\lambda,\omega}$ for $\lambda \neq 0$. This implies that $\bar{\mu}^\omega(\{\omega\}) = 0$. By the theorem of de la Vallée Poussin (for detailed proof see e.g. [Ja]), $\bar{\mu}_{\text{sing}}^\omega$ is concentrated on the set

$$\{x \mid x \neq \omega \text{ and } \lim_{y \downarrow 0} P_\omega(x + iy) = \infty\}.$$

By Lemma 2, this set is contained in

$$\mathcal{S} \equiv \{x \mid \lim_{y \downarrow 0} F_{\mathcal{R}}(x + iy) = 0\}.$$

Since $\mathcal{S} \cap S_{\lambda,\omega} \subset \{\omega\}$, Theorem 1 implies that $\mu_{\text{sing}}^{\lambda,\omega}(\mathcal{S}) = 0$ for all $\lambda \neq 0$. Since $|\mathcal{S}| = 0$, $\mu_{\text{ac}}^{\lambda,\omega}(\mathcal{S}) = 0$ for all λ . We conclude that $\mu^{\lambda,\omega}(\mathcal{S}) = 0$ for all $\lambda \neq 0$, and so

$$\bar{\mu}^\omega(\mathcal{S}) = \int_{\mathbb{R}} \mu^{\lambda,\omega}(\mathcal{S}) d\lambda = 0.$$

Hence, $\bar{\mu}_{\text{sing}}^\omega = 0$. From Theorem 1 we now get

$$d\bar{\mu}^\omega(x) = d\bar{\mu}_{\text{ac}}^\omega(x) = \frac{1}{\pi} \text{Im } F_\omega(x + i0) dx,$$

and (35) follows from Lemma 2. The remaining statements are obvious. \square

We are now ready to state and prove the Simon-Wolff theorems for fixed ω .

Theorem 7. *Let $B \subset \mathbb{R}$ be a Borel set. Consider the following statements:*

1. $G_{\mathcal{R}}(x) < \infty$ for Lebesgue a.e. $x \in B$.
2. $\mu_{\text{cont}}^{\lambda,\omega}(B) = 0$ for Lebesgue a.e. $\lambda \in \mathbb{R}$.

Then (1) \Rightarrow (2). If $B \subset \mathcal{E}$, then also (2) \Rightarrow (1).

Proof. Let $A \equiv \{x \in B \mid G_{\mathcal{R}}(x) = \infty\} \cap \mathcal{E}$.

(1) \Rightarrow (2) By assumption, A has zero Lebesgue measure. Theorem 6 yields that $\bar{\mu}^\omega(A) = 0$. Since $G_{\mathcal{R}}(x) < \infty$ for Lebesgue a.e. $x \in B$, $\text{Im } F_{\mathcal{R}}(x + i0) = 0$ for Lebesgue a.e. $x \in B$. Hence, for all λ , $\text{Im } F_{\lambda,\omega}(x + i0) = 0$ for Lebesgue a.e. $x \in B$. By Theorem 1, $\mu_{\text{ac}}^{\lambda,\omega}(B) = 0$ and the measure $\mu_{\text{sc}}^{\lambda,\omega}|_B$ is concentrated on the set A for all $\lambda \neq 0$. Then,

$$\int_{\mathbb{R}} \mu_{\text{sc}}^{\lambda,\omega}(B) d\lambda = \int_{\mathbb{R}} \mu_{\text{sc}}^{\lambda,\omega}(A) d\lambda \leq \int_{\mathbb{R}} \mu^{\lambda,\omega}(A) d\lambda = \bar{\mu}^\omega(A) = 0.$$

Hence, $\mu_{\text{sc}}^{\lambda,\omega}(B) = 0$ for Lebesgue a.e. λ .

(2) \Rightarrow (1) Assume that the set A has positive Lebesgue measure. By Theorem 1, $\mu_{\text{pp}}^{\lambda,\omega}(A) = 0$ for all $\lambda \neq 0$, and

$$\int_{\mathbb{R}} \mu_{\text{cont}}^{\lambda,\omega}(A) d\lambda = \int_{\mathbb{R}} \mu^{\lambda,\omega}(A) d\lambda = \bar{\mu}^\omega(A) > 0.$$

Hence, for a set of λ 's of positive Lebesgue measure, $\mu_{\text{cont}}^{\lambda,\omega}(B) > 0$. \square

Theorem 8. Let $B \subset \mathbb{R}$ be a Borel set. Consider the following statements:

1. $\text{Im } F_{\mathcal{R}}(x + i0) = 0$ and $G_{\mathcal{R}}(x) = \infty$ for Lebesgue a.e. $x \in B$.
2. $\mu_{\text{ac}}^{\lambda, \omega}(B) + \mu_{\text{pp}}^{\lambda, \omega}(B) = 0$ for Lebesgue a.e. $\lambda \in \mathbb{R}$.

Then (1) \Rightarrow (2). If $B \subset \mathcal{E}$, then also (2) \Rightarrow (1).

Proof. Let $A \equiv \{x \in B \mid G_{\mathcal{R}}(x) < \infty\} \cap \mathcal{E}$.

(1) \Rightarrow (2) Since $\text{Im } F_{\mathcal{R}}(x + i0) = 0$ for Lebesgue a.e. $x \in B$, Theorem 1 implies that $\mu_{\text{ac}}^{\lambda, \omega}(B) = 0$ for all λ . By Theorems 1 and 6, for $\lambda \neq 0$, $\mu_{\text{pp}}^{\lambda, \omega}|_B$ is concentrated on the set A . Since A has Lebesgue measure zero,

$$\int_{\mathbb{R}} \mu_{\text{pp}}^{\lambda, \omega}(A) \, d\lambda \leq \bar{\mu}^{\omega}(A) = 0,$$

and so $\mu_{\text{pp}}^{\lambda, \omega}(B) = 0$ for Lebesgue a.e. λ .

(2) \Rightarrow (1) If $\text{Im } F_{\mathcal{R}}(x + i0) > 0$ for a set of $x \in B$ of positive Lebesgue measure, then, by Theorem 1, $\mu_{\text{ac}}^{\lambda, \omega}(B) > 0$ for all λ . Assume that $\text{Im } F_{\mathcal{R}}(x + i0) = 0$ for Lebesgue a.e. $x \in B$ and that A has positive Lebesgue measure. By Theorem 1, $\mu_{\text{cont}}^{\lambda, \omega}(A) = 0$ for all $\lambda \neq 0$ and since $A \subset \mathcal{E}$, Theorem 6 implies

$$\int_{\mathbb{R}} \mu_{\text{pp}}^{\lambda, \omega}(A) \, d\lambda = \int_{\mathbb{R}} \mu^{\lambda, \omega}(A) \, d\lambda = \bar{\mu}^{\omega}(A) > 0.$$

Thus, we must have that $\mu_{\text{pp}}^{\lambda, \omega}(B) > 0$ for a set of λ 's of positive Lebesgue measure. \square

Theorem 9. Let $B \subset \mathbb{R}$ be a Borel set. Consider the following statements:

1. $\text{Im } F_{\mathcal{R}}(x + i0) > 0$ for Lebesgue a.e. $x \in B$.
2. $\mu_{\text{sing}}^{\lambda, \omega}(B) = 0$ for Lebesgue a.e. $\lambda \in \mathbb{R}$.

Then (1) \Rightarrow (2). If $B \subset \mathcal{E}$, then also (2) \Rightarrow (1).

Proof. (1) \Rightarrow (2) By Theorem 1, for $\lambda \neq 0$ the measure $\mu_{\text{sing}}^{\lambda, \omega}|_B$ is concentrated on the set $A \equiv \{x \in B \mid \text{Im } F_{\mathcal{R}}(x + i0) = 0\} \cap \mathcal{E}$. By assumption, A has Lebesgue measure zero and

$$\int_{\mathbb{R}} \mu_{\text{sing}}^{\lambda, \omega}(A) \, d\lambda \leq \int_{\mathbb{R}} \mu^{\lambda, \omega}(A) \, d\lambda = \bar{\mu}^{\omega}(A) = 0.$$

Hence, for Lebesgue a.e. $\lambda \in \mathbb{R}$, $\mu_{\text{sing}}^{\lambda, \omega}(B) = 0$.

(2) \Rightarrow (1) Assume that $B \subset \mathcal{E}$ and that the set

$$A \equiv \{x \in B \mid \text{Im } F_{\mathcal{R}}(x + i0) = 0\},$$

has positive Lebesgue measure. By Theorem 1, $\mu_{\text{ac}}^{\lambda, \omega}(A) = 0$ for all λ , and

$$\int_{\mathbb{R}} \mu_{\text{sing}}^{\lambda, \omega}(A) \, d\lambda = \int_{\mathbb{R}} \mu^{\lambda, \omega}(A) \, d\lambda = \bar{\mu}^{\omega}(A) > 0.$$

Hence, for a set of λ 's of positive Lebesgue measure, $\mu_{\text{sing}}^{\lambda, \omega}(B) > 0$. \square

2.8 Examples

In all examples in this subsection $\mathfrak{h}_{\mathcal{R}} = L^2([a, b], d\mu_{\mathcal{R}})$ and $h_{\mathcal{R}}$ is the operator of multiplication by x . In Examples 1-9 $[a, b] = [0, 1]$. In Examples 1 and 2 we do not assume that f is a cyclic vector for $h_{\mathcal{R}}$.

Example 1. In this example we deal with the spectrum outside $]0, 1[$. Let

$$\Lambda_0 = \int_0^1 \frac{|f(x)|^2}{x} d\mu_{\mathcal{R}}(x), \quad \Lambda_1 = \int_0^1 \frac{|f(x)|^2}{x-1} d\mu_{\mathcal{R}}(x).$$

Obviously, $\Lambda_0 \in]0, \infty]$ and $\Lambda_1 \in [-\infty, 0[$. If $\lambda^2 > \omega/\Lambda_0$, then $h_{\lambda, \omega}$ has a unique eigenvalue $e < 0$ which satisfies

$$\omega - e - \lambda^2 \int_0^1 \frac{|f(x)|^2}{x-e} d\mu_{\mathcal{R}}(x) = 0. \quad (36)$$

If $\lambda^2 < \omega/\Lambda_0$, then $h_{\lambda, \omega}$ has no eigenvalue in $] -\infty, 0[$. 0 is an eigenvalue of $h_{\lambda, \omega}$ iff $\lambda^2 = \omega/\Lambda_0$ and $\int_0^1 |f(x)|^2 x^{-2} d\mu_{\mathcal{R}}(x) < \infty$. Similarly, if

$$(\omega - 1)/\Lambda_1 < \lambda^2,$$

then $h_{\lambda, \omega}$ has a unique eigenvalue $e > 1$ which satisfies (36), and if

$$(\omega - 1)/\Lambda_1 > \lambda^2,$$

then $h_{\lambda, \omega}$ has no eigenvalue in $]1, \infty[$. 1 is an eigenvalue of $h_{\lambda, \omega}$ iff

$$(\omega - 1)/\Lambda_1 = \lambda^2,$$

and $\int_0^1 |f(x)|^2 (x-1)^{-2} d\mu_{\mathcal{R}}(x) < \infty$.

Example 2. Let $d\mu_{\mathcal{R}}(x) \equiv dx|_{[0, 1]}$, let f be a continuous function on $]0, 1[$, and let

$$\mathcal{S} = \{x \in]0, 1[\mid f(x) \neq 0\}.$$

The set \mathcal{S} is open in $]0, 1[$, and the cyclic space generated by $h_{\mathcal{R}}$ and f is $L^2(\mathcal{S}, dx)$. The spectrum of

$$h_{\lambda, \omega}|_{(\mathbb{C} \oplus L^2(\mathcal{S}, dx))^\perp},$$

is purely absolutely continuous and equal to $[0, 1] \setminus \mathcal{S}$. Since for $x \in \mathcal{S}$, $\lim_{y \downarrow 0} \text{Im } F_{\mathcal{R}}(x+iy) = \pi |f(x)|^2 > 0$, the spectrum of $h_{\lambda, \omega}$ in \mathcal{S} is purely absolutely continuous for all $\lambda \neq 0$. Hence, if

$$\mathcal{S} = \bigcup_n]a_n, b_n[,$$

is the decomposition of \mathcal{S} into connected components, then the singular spectrum of $h_{\lambda, \omega}$ inside $[0, 1]$ is concentrated on the set $\cup_n \{a_n, b_n\}$. In particular, $h_{\lambda, \omega}$ has no singular continuous spectrum. A point $e \in \cup_n \{a_n, b_n\}$ is an eigenvalue of $h_{\lambda, \omega}$ iff

$$\int_0^1 \frac{|f(x)|^2}{(x-e)^2} dx < \infty \quad \text{and} \quad \omega - e - \lambda^2 \int_0^1 \frac{|f(x)|^2}{x-e} dx = 0. \quad (37)$$

Given ω , for each e for which the first condition holds there are precisely two λ 's such that e is an eigenvalue of $h_{\lambda,\omega}$. Hence, given ω , the set of λ 's for which $h_{\lambda,\omega}$ has eigenvalues in $]0, 1[$ is countable. Similarly, given λ , the set of ω 's for which $h_{\lambda,\omega}$ has eigenvalues in $]0, 1[$ is countable.

Let

$$Z \equiv \{x \in [0, 1] \mid f(x) = 0\},$$

and $\mathfrak{g} \equiv \sup_{x \in Z} G_{\mathcal{R}}(x)$. By (16), the number of eigenvalues of $h_{\lambda,\omega}$ is bounded by $1 + \lambda^2 \mathfrak{g}$. Hence, if $\mathfrak{g} < \infty$, then $h_{\lambda,\omega}$ can have at most finitely many eigenvalues. If, for example, f is δ -Hölder continuous, *i.e.*,

$$|f(x) - f(y)| \leq C|x - y|^\delta,$$

for all $x, y \in [0, 1]$ and some $\delta > 1/2$, then

$$\begin{aligned} \mathfrak{g} &= \sup_{x \in Z} \int_0^1 \frac{|f(t)|^2}{(t-x)^2} dt = \sup_{x \in Z} \int_0^1 \frac{|f(t) - f(x)|^2}{(t-x)^2} dt \\ &\leq \sup_{x \in Z} \int_0^1 \frac{C}{(t-x)^{2(1-\delta)}} dt < \infty, \end{aligned}$$

and $h_{\lambda,\omega}$ has at most finitely many eigenvalues. On the other hand, given $\lambda \neq 0$, ω , and a finite sequence $E \equiv \{e_1, \dots, e_n\} \subset]0, 1[$, one can construct a C^∞ function f with bounded derivatives such that E is precisely the set of eigenvalues of $h_{\lambda,\omega}$ in $]0, 1[$.

More generally, let $E \equiv \{e_n\} \subset]0, 1[$ be a discrete set. (By discrete we mean that for all n , $\inf_{j \neq n} |e_n - e_j| > 0$ — the accumulation points of E are not in E .) Let $\lambda \neq 0$ and ω be given and assume that ω is not an accumulation point of E . Then there is a C^∞ function f such that E is precisely the set of eigenvalues of $h_{\lambda,\omega}$ in $]0, 1[$. Of course, in this case $f'(x)$ cannot be bounded. The construction of a such f is somewhat lengthy and can be found in [Kr].

In the remaining examples we take $f \equiv 1$. The next two examples are based on [How].

Example 3. Let $\mu_{\mathcal{R}}$ be a pure point measure with atoms $\mu_{\mathcal{R}}(x_n) = a_n$. Then

$$G_{\mathcal{R}}(x) = \sum_{n=1}^{\infty} \frac{a_n}{(x - x_n)^2}.$$

If $\sum_n \sqrt{a_n} < \infty$, then $G_{\mathcal{R}}(x) < \infty$ for Lebesgue a.e. $x \in [0, 1]$ (see Theorem 3.1 in [How]). Hence, by Simon-Wolff theorems 3 and 7, for a fixed $\lambda \neq 0$ and Lebesgue a.e. ω , and for a fixed ω and Lebesgue a.e. λ , $h_{\lambda,\omega}$ has only a pure point spectrum. On the other hand, for a fixed $\lambda \neq 0$, there is a dense G_δ set of $\omega \in \mathbb{R}$ such that the spectrum of $h_{\lambda,\omega}$ on $]0, 1[$ is purely singular continuous [Gor, DMS].

Example 4 (continuation). Assume that $x_n = x_n(w)$ are independent random variables uniformly distributed on $[0, 1]$. We keep the a_n 's deterministic and assume that $\sum \sqrt{a_n} = \infty$. Then, for a.e. w , $G_{\mathcal{R},w}(x) = \infty$ for Lebesgue a.e. $x \in [0, 1]$ (see Theorem 3.2 in [How]). Hence, by Simon-Wolff theorems 4 and 8, for a fixed $\lambda \neq 0$ and Lebesgue a.e. ω , and for a fixed ω and Lebesgue a.e. λ , the spectrum of $h_{\lambda,\omega}(w)$ on $[0, 1]$ is singular continuous with probability 1.

Example 5. Let ν be an arbitrary probability measure on $[0, 1]$. Let

$$d\mu_{\mathcal{R}}(x) = \frac{1}{2} (dx|_{[0,1]} + d\nu(x)).$$

Since for all $x \in]0, 1[$,

$$\liminf_{y \downarrow 0} \operatorname{Im} F_{\mathcal{R}}(x + iy) \geq \frac{\pi}{2},$$

the operator $h_{\lambda,\omega}$ has purely absolutely continuous spectrum on $[0, 1]$ for all $\lambda \neq 0$. In particular, the singular spectrum of ν disappears under the influence of the perturbation for all $\lambda \neq 0$.

Example 6. This example is due to Simon-Wolff [SW]. Let

$$\mu_n = 2^{-n} \sum_{j=1}^{2^n} \delta_{j2^{-n}},$$

and $\mu_{\mathcal{R}} = \sum_n a_n \mu_n$, where $a_n > 0$, $\sum_n a_n = 1$ and $\sum_n 2^n a_n = \infty$. The spectrum of $h_{0,\omega}$ is pure point and equal to $[0, 1] \cup \{\omega\}$. For any $x \in [0, 1]$ there is j_x such that $|j_x/2^n - x| \leq 2^{-n}$. Hence, for all n ,

$$\int_{\mathbb{R}} \frac{d\mu_n(t)}{(t-x)^2} \geq 2^n,$$

and $G_{\mathcal{R}}(x) = \infty$ for all $x \in [0, 1]$. We conclude that for all $\lambda \neq 0$ and all ω the spectrum of $h_{\lambda,\omega}$ on $[0, 1]$ is purely singular continuous.

Example 7. Let μ_C be the standard Cantor measure (see [RS1]). Set

$$\nu_{j,n}(A) \equiv \mu_C(A + j2^{-n}),$$

and

$$\mu_{\mathcal{R}} \equiv c \chi_{[0,1]} \sum_{n=1}^{\infty} n^{-2} \sum_{j=1}^{2^n} \nu_{j,n},$$

where c is the normalization constant. Then $G_{\mathcal{R}}(x) = \infty$ for all $x \in [0, 1]$ (see Example 5 in Section II.5 of [Si2]), and the spectrum of $h_{\lambda,\omega}$ on $[0, 1]$ is purely singular continuous for all λ, ω .

Example 8. The following example is due to del Rio and Simon [DS] (see also Example 7 in Section II.5 of [Si2]). Let $\{r_n\}$ be the set of rationals in $[0, 1]$, $a_n \equiv \min(3^{-n-1}, r_n, 1 - r_n)$, and $S \equiv \cup_n (r_n - a_n, r_n + a_n)$. The set S is dense in $[0, 1]$ and $|S| \leq 1/3$. Let $d\mu_{\mathcal{R}} = |S|^{-1} \chi_S dx$. The spectrum of $h_{\mathcal{R}}$ is purely absolutely continuous and equal to $[0, 1]$. The set S is the essential support of this absolutely continuous spectrum. Clearly, for all λ, ω , $\text{sp}_{\text{ac}}(h_{\lambda, \omega}) = [0, 1]$. By Theorem 5, for any fixed $\lambda \neq 0$, $h_{\lambda, \omega}$ will have some singular spectrum in $[0, 1] \setminus S$ for a set of ω 's of positive Lebesgue measure. It is not difficult to show that $G_{\mathcal{R}}(x) < \infty$ for Lebesgue a.e. $x \in [0, 1] \setminus S$. Hence, for a fixed λ , $h_{\lambda, \omega}$ will have no singular continuous spectrum for Lebesgue a.e. ω but it has some point spectrum in $[0, 1] \setminus S$ for a set of ω 's of positive Lebesgue measure.

For a given ω , $h_{\lambda, \omega}$ has no singular continuous spectrum for Lebesgue a.e. λ . Since the set S is symmetric with respect to the point $1/2$, we have that for all $z \in \mathbb{C}_{\pm}$, $\text{Re } F_{\mathcal{R}}(z) = -\text{Re } F_{\mathcal{R}}(-z + 1/2)$. Hence,

$$\text{Re } F_{\mathcal{R}}(x) = -\text{Re } F_{\mathcal{R}}(-x + 1/2), \quad (38)$$

and if $|\omega| \geq 1$, then the set

$$\{x \in [0, 1] \setminus S \mid (\omega - x)F_{\mathcal{R}}(x) > 0\}, \quad (39)$$

has positive Lebesgue measure. Theorem 9 yields that for a given $\omega \notin]0, 1[$, $h_{\lambda, \omega}$ will have some point spectrum in $[0, 1] \setminus S$ for a set of λ 's of positive Lebesgue measure. If $\omega \in]0, 1[$, the situation is more complex and depends on the choice of enumeration of the rationals. The enumeration can be always chosen in such a way that for all $0 < \epsilon < 1$, $|S \cap [0, \epsilon]| < \epsilon$. In this case for any given ω the set (39) has positive Lebesgue measure and $h_{\lambda, \omega}$ will have some singular continuous spectrum in $[0, 1] \setminus S$ for a set of λ 's of positive Lebesgue measure.

Example 9. This example is also due to del Rio and Simon [DS] (see also Example 8 in Section II.5 of [Si2]). Let

$$S_n = \bigcup_{j=1}^{2^n-1} \left] \frac{j}{2^n} - \frac{1}{4n^2 2^n}, \frac{j}{2^n} + \frac{1}{4n^2 2^n} \right[,$$

and $S = \cup_n S_n$. The set S is dense in $[0, 1]$ and $|S| < 1$. Let $d\mu_{\mathcal{R}} = |S|^{-1} \chi_S dx$. Then the absolutely continuous spectrum of $h_{\lambda, \omega}$ is equal to $[0, 1]$ for all λ, ω . One easily shows that $G_{\mathcal{R}}(x) = \infty$ on $[0, 1]$. Hence, for a fixed λ , $h_{\lambda, \omega}$ will have no point spectrum on $[0, 1]$ for Lebesgue a.e. ω but it has some singular continuous spectrum in $[0, 1] \setminus S$ for a set of ω 's of positive Lebesgue measure.

For a given ω , $h_{\lambda, \omega}$ will have no point spectrum inside $[0, 1]$ for Lebesgue a.e. λ . The set S is symmetric with respect to $1/2$ and (38) holds. Since for any $0 < \epsilon < 1$, $|S \cap [0, \epsilon]| < \epsilon$, for any given ω the set

$$\{x \in [0, 1] \setminus S \mid (\omega - x)F_{\mathcal{R}}(x) > 0\},$$

has positive Lebesgue measure. Hence, Theorem 9 yields that for a given ω , $h_{\lambda,\omega}$ will have some singular continuous spectrum in $[0, 1] \setminus S$ for a set of λ 's of positive Lebesgue measure.

Example 10. Proposition 1 and a theorem of del Rio and Simon [DS] yield that there exist a bounded interval $[a, b]$, a Borel probability measure $\mu_{\mathcal{R}}$ on $[a, b]$ and $\lambda_0 > 0$ such that:

1. $\text{sp}_{\text{ac}}(h_{\lambda,\omega}) = [a, b]$ for all λ, ω .
2. for a set of ω 's of positive Lebesgue measure, h_{ω,λ_0} has embedded point spectrum in $[a, b]$.
3. for a set of ω 's of positive Lebesgue measure, h_{ω,λ_0} has embedded singular continuous spectrum in $[a, b]$.

Example 11. Proposition 1 and a theorem of del Rio-Fuentes-Poltoratskii [DFP] yield that there exist a bounded interval $[a, b]$, a Borel probability measure $\mu_{\mathcal{R}}$ on $[a, b]$ and $\lambda_0 > 0$ such that:

1. $\text{sp}_{\text{ac}}(h_{\lambda,\omega}) = [a, b]$ for all λ, ω .
2. for all $\omega \in [0, 1]$, the spectrum of h_{ω,λ_0} is purely absolutely continuous.
3. for all $\omega \notin [0, 1]$, $[a, b] \subset \text{sp}_{\text{sing}}(h_{\omega,\lambda_0})$.

2.9 Digression: the semi-circle law

In the proof of Proposition 1 we have solved the equation (11) for $\mu_{\mathcal{R}}$. In this subsection we will find the fixed point of the equation (11). More precisely, we will find a finite Borel measure ν whose Borel transform satisfies the functional equation

$$H(z) = \frac{1}{-z - \lambda^2 H(z)},$$

or, equivalently

$$\lambda^2 H(z)^2 + zH(z) + 1 = 0. \quad (40)$$

The unique analytic solution of this equation is

$$H(z) = \frac{\sqrt{z^2 - 4\lambda^2} - z}{2\lambda^2},$$

a two-valued function which can be made single valued by cutting the complex plane along the line segment $[-2|\lambda|, 2|\lambda|]$. Only one branch has the Herglotz property $H(\mathbb{C}_+) \subset \mathbb{C}_+$. This branch is explicitly given by

$$H(z) = \frac{1}{|\lambda|} \frac{\xi - 1}{\xi + 1}, \quad \xi \equiv \sqrt{\frac{z - 2|\lambda|}{z + 2|\lambda|}},$$

where the branch of the square root is determined by $\text{Re } \xi > 0$ (the so-called principal branch). In particular, $H(x+iy) \sim iy^{-1}$ as $y \rightarrow +\infty$, and by a well known result

in harmonic analysis (see e.g. [Ja]) there exists a unique Borel probability measure ν such that $F_\nu(z) = H(z)$ for $z \in \mathbb{C}_+$. For all $x \in \mathbb{R}$,

$$\lim_{y \downarrow 0} \operatorname{Im} F_\nu(x + iy) = h_\lambda(x),$$

where

$$h_\lambda(x) = \begin{cases} \frac{\sqrt{4\lambda^2 - x^2}}{2\lambda^2} & \text{if } |x| \leq 2|\lambda|, \\ 0 & \text{if } |x| > 2|\lambda|. \end{cases}$$

We deduce that the measure ν is absolutely continuous w.r.t. Lebesgue measure and that

$$d\nu(x) = \pi^{-1} h_\lambda(x) dx.$$

Of course, ν is the celebrated Wigner semi-circle law which naturally arises in the study of the eigenvalue distribution of certain random matrices, see e.g. [Meh]. The result of this computation will be used in several places in the remaining part of our lectures.

3 The perturbative theory

3.1 The Radiating Wigner-Weisskopf atom

In this section we consider a specific class of WWA models which satisfy the following set of assumptions.

Assumption (A1) $\mathfrak{h}_{\mathcal{R}} = L^2(X, dx; \mathfrak{K})$, where $X = (e_-, e_+) \subset \mathbb{R}$ is an open (possibly infinite) interval and \mathfrak{K} is a separable Hilbert space. The Hamiltonian $h_{\mathcal{R}} \equiv x$ is the operator of multiplication by x .

Note that the spectrum of $h_{\mathcal{R}}$ is purely absolutely continuous and equal to \bar{X} . For notational simplicity in this section we do not assume that f is a cyclic vector for $h_{\mathcal{R}}$. This assumption is irrelevant for our purposes: since the cyclic space \mathfrak{h}_1 generated by h_λ and 1 is independent of λ for $\lambda \neq 0$, so is $\mathfrak{h}_1^\perp \subset \mathfrak{h}_{\mathcal{R}}$ and $h_\lambda|_{\mathfrak{h}_1^\perp} = h_{\mathcal{R}}|_{\mathfrak{h}_1^\perp}$ has purely absolutely continuous spectrum.

Assumption (A2) The function

$$g(t) = \int_X e^{-itx} \|f(x)\|_{\mathfrak{K}}^2 dx,$$

is in $L^1(\mathbb{R}, dt)$.

This assumption implies that $x \mapsto \|f(x)\|_{\mathfrak{K}}$ is a bounded continuous function on \bar{X} . Note also that for $\operatorname{Im} z > 0$,

$$F_{\mathcal{R}}(z) = \int_X \frac{\|f(x)\|_{\mathfrak{R}}^2}{x-z} dx = i \int_0^\infty e^{izs} g(s) ds.$$

Hence, $F_{\mathcal{R}}(z)$ is bounded and continuous on the closed half-plane $\overline{\mathbb{C}_+}$. In particular, the function $F_{\mathcal{R}}(x+i0)$ is bounded and continuous on \mathbb{R} . If in addition $t^n g(t) \in L^1(\mathbb{R}, dt)$ for some positive integer n , then $\|f(x)\|_{\mathfrak{R}}^2$ and $F_{\mathcal{R}}(x+i0)$ are n -times continuously differentiable with bounded derivatives.

Assumption (A3) $\omega \in X$ and $\|f(\omega)\|_{\mathfrak{R}} > 0$.

This assumption implies that the eigenvalue ω of h_0 is embedded in its absolutely continuous spectrum.

Until the end of this section we will assume that Assumptions (A1)-(A3) hold. We will call the WWA which satisfies (A1)-(A3) the Radiating Wigner-Weisskopf Atom (abbreviated RWWA).

In contrast to the previous section, until the end of the paper we will keep ω fixed and consider *only* λ as the perturbation parameter. In the sequel we drop the subscript ω and write F_λ for $F_{\lambda, \omega}$, etc.

Since $\|f(x)\|_{\mathfrak{R}}$ is a continuous function of x , the argument of Example 2 in Subsection 2.8 yields that h_λ has no singular continuous spectrum for all λ . However, h_λ may have eigenvalues (and, if $X \neq \mathbb{R}$, it will certainly have them for λ large enough). For λ small, however, the spectrum of h_λ is purely absolutely continuous.

Proposition 7. *There exists $\Lambda > 0$ such that, for $0 < |\lambda| < \Lambda$, the spectrum of h_λ is purely absolutely continuous and equal to \bar{X} .*

Proof. By Theorem 1, the singular spectrum of h_λ is concentrated on the set

$$S = \{x \in \mathbb{R} \mid \omega - x - \lambda^2 F_{\mathcal{R}}(x+i0) = 0\}.$$

Since $\text{Im } F_{\mathcal{R}}(\omega+i0) = \pi \|f(\omega)\|_{\mathfrak{R}}^2 > 0$, there is $\epsilon > 0$ such that

$$\text{Im } F_{\mathcal{R}}(x+i0) > 0,$$

for $|x - \omega| < \epsilon$. Let $m \equiv \max_{x \in \mathbb{R}} |F_{\mathcal{R}}(x+i0)|$ and $\Lambda \equiv (\epsilon/m)^{1/2}$. Then, for $|\lambda| < \Lambda$ and $x \notin [\omega - \epsilon, \omega + \epsilon]$, one has $|\omega - x| > \lambda^2 |F_{\mathcal{R}}(x+i0)|$. Hence, S is empty for $0 < |\lambda| < \Lambda$, and the spectrum of $h_\lambda|_{\mathfrak{h}_1}$ is purely absolutely continuous. \square

We finish this subsection with two examples.

Example 1. Assume that $\mathfrak{h}_{\mathcal{R}} = L^2(\mathbb{R}^d, d^d x)$ and let $h_{\mathcal{R}} = -\Delta$, where Δ is the usual Laplacian in \mathbb{R}^d . The Fourier transform

$$\tilde{\varphi}(k) = \frac{1}{(2\pi)^{d/2}} \int_{\mathbb{R}^d} e^{-ik \cdot x} \varphi(x) dx,$$

maps unitarily $L^2(\mathbb{R}^d, d^d x)$ onto $L^2(\mathbb{R}^d, d^d k)$ and the Hamiltonian $h_{\mathcal{R}}$ becomes multiplication by $|k|^2$. By passing to polar coordinates with $r = |k|$ we identify

$L^2(\mathbb{R}^d, d^d k)$ with $L^2(\mathbb{R}_+, r^{d-1} dr; \mathfrak{K})$, where $\mathfrak{K} = L^2(S^{d-1}, d\sigma)$, S^{d-1} is the unit sphere in \mathbb{R}^d , and $d\sigma$ is its surface measure. The operator $h_{\mathcal{R}}$ becomes multiplication by r^2 . Finally, the map

$$\varphi^\#(x) = 2^{-1/2} x^{\frac{d-2}{4}} \tilde{\varphi}(\sqrt{x}),$$

maps $L^2(\mathbb{R}^d, d^d x)$ unitarily onto $L^2(X, dx; \mathfrak{K})$ with $X = (0, \infty)$, and

$$(h_{\mathcal{R}}\varphi)^\#(x) = x\varphi^\#(x).$$

This representation of $\mathfrak{h}_{\mathcal{R}}$ and $h_{\mathcal{R}}$ (sometimes called the *spectral* or the *energy* representation) clearly satisfies (A1).

The function $f^\#$ satisfies (A2) iff the function $g(t) = (f|e^{-it h_{\mathcal{R}}} f)$ is in $L^1(\mathbb{R}, dt)$. If $f \in L^2(\mathbb{R}^d, d^d x)$ is compactly supported, then $g(t) = O(t^{-d/2})$, and so if $d \geq 3$, then (A2) holds for all compactly supported f . If $d = 1, 2$, then (A2) holds if f is in the domain of $|x|^2$ and its Fourier transform vanishes in a neighborhood of the origin. The proofs of these facts are simple and can be found in [BR2], Example 5.4.9.

Example 2. Let $\mathfrak{h}_{\mathcal{R}} = \ell^2(\mathbb{Z}_+)$, where $\mathbb{Z}_+ = \{1, 2, \dots\}$, and let

$$h_{\mathcal{R}} = \frac{1}{2} \sum_{n \in \mathbb{Z}_+} \left((\delta_n | \cdot) \delta_{n+1} + (\delta_{n+1} | \cdot) \delta_n \right),$$

where δ_n is the Kronecker delta function at $n \in \mathbb{Z}_+$. $h_{\mathcal{R}}$ is the usual discrete Laplacian on $\ell^2(\mathbb{Z}_+)$ with Dirichlet boundary condition. The Fourier-sine transform

$$\tilde{\varphi}(k) \equiv \sqrt{\frac{2}{\pi}} \sum_{n \in \mathbb{Z}_+} \varphi(n) \sin(kn),$$

maps $\ell^2(\mathbb{Z}_+)$ unitarily onto $L^2([0, \pi], dk)$ and the Hamiltonian $h_{\mathcal{R}}$ becomes multiplication by $\cos k$. Finally, the map

$$\varphi^\#(x) = (1 - x^2)^{-1/4} \tilde{\varphi}(\arccos x),$$

maps $\ell^2(\mathbb{Z}_+)$ unitarily onto $L^2(X, dx)$, where $X = (-1, 1)$ and

$$(h_{\mathcal{R}}\varphi)^\#(x) = x\varphi^\#(x).$$

If f has bounded support in \mathbb{Z}_+ , then $|f^\#(x)|^2 = (1 - x^2)^{1/2} P_f(x)$, where $P_f(x)$ is a polynomial in x . A simple stationary phase argument yields that $g(t) = O(|t|^{-3/2})$ and Assumption (A2) holds.

3.2 Perturbation theory of embedded eigenvalue

Until the end of this section A is the constant in Proposition 7.

Note that the operator $h_0 = \omega \oplus x$ has the eigenvalue ω embedded in the absolutely continuous spectrum of x . On the other hand, for $0 < |\lambda| < \Lambda$ the operator h_λ has no eigenvalue—the embedded eigenvalue has “dissolved” in the absolutely continuous spectrum under the influence of the perturbation. In this subsection we will analyze this phenomenon. At its heart are the concepts of *resonance* and *life-time* of an embedded eigenvalue which are of profound physical importance.

We set $D(\omega, r) \equiv \{z \in \mathbb{C} \mid |z - \omega| < r\}$. In addition to (A1)-(A3) we will need the following assumption.

Assumption (A4) There exists $\rho > 0$ such that the function

$$\mathbb{C}_+ \ni z \rightarrow F_{\mathcal{R}}(z),$$

has an analytic continuation across the interval $]\omega - \rho, \omega + \rho[$ to the region $\mathbb{C}_+ \cup D(\omega, \rho)$. We denote the extended function by $F_{\mathcal{R}}^+(z)$.

It is important to note that for $\text{Im } z < 0$, $F_{\mathcal{R}}^+(z)$ is *different* from $F_{\mathcal{R}}(z)$. This is obvious from the fact that

$$\text{Im } F_{\mathcal{R}}(x + i0) - \text{Im } F_{\mathcal{R}}(x - i0) = 2\pi \|f(x)\|_{\mathfrak{R}}^2 > 0,$$

near ω . In particular, if (A4) holds, then ρ must be such that $]\omega - \rho, \omega + \rho[\subset X$.

Until the end of this subsection we will assume that Assumptions (A1)-(A4) hold.

Theorem 10. 1. The function $F_\lambda(z) = (1|(h_\lambda - z)^{-1}1)$ has a meromorphic continuation from \mathbb{C}_+ to the region $\mathbb{C}_+ \cup D(\omega, \rho)$. We denote this continuation by $F_\lambda^+(z)$.

2. Let $0 < \rho' < \rho$ be given. Then there is $\Lambda' > 0$ such that for $|\lambda| < \Lambda'$ the only singularity of $F_\lambda^+(z)$ in $D(\omega, \rho')$ is a simple pole at $\omega(\lambda)$. The function $\lambda \mapsto \omega(\lambda)$ is analytic for $|\lambda| < \Lambda'$ and

$$\omega(\lambda) = \omega + a_2 \lambda^2 + O(\lambda^4),$$

where $a_2 \equiv -F_{\mathcal{R}}(\omega + i0)$. In particular, $\text{Im } a_2 = -\pi \|f(\omega)\|_{\mathfrak{R}}^2 < 0$.

Proof. Part (1) is simple—Assumption A4 and Equ. (8) yield that

$$F_\lambda^+(z) = \frac{1}{\omega - z - \lambda^2 F_{\mathcal{R}}^+(z)},$$

is the meromorphic continuation of $\mathbb{C}_+ \ni z \mapsto F_\lambda(z)$ to $\mathbb{C}_+ \cup D(\omega, \rho)$.

For a given ρ' , choose $\Lambda' > 0$ such that

$$\rho' > |\Lambda'|^2 \sup_{|z|=\rho'} |F_{\mathcal{R}}^+(z)|.$$

By Rouché’s theorem, there is an $\epsilon > 0$ such that for $|\lambda| < \Lambda'$ the function $\omega - z - \lambda^2 F_{\mathcal{R}}^+(z)$ has a unique simple zero $\omega(\lambda)$ inside $D(\omega, \rho' + \epsilon)$ such that $|\omega(\lambda) - \omega| <$

$\rho' - \epsilon$. This yields that $F_\lambda^+(z)$ is analytic in $\mathbb{C}_+ \cup D(\omega, \rho' + \epsilon)$ except for a simple pole at $\omega(\lambda)$. The function

$$P(\lambda) \equiv \oint_{|\omega-z|=\rho'} z F_\lambda^+(z) dz = \sum_{n=0}^{\infty} \lambda^{2n} \oint_{|\omega-z|=\rho'} z \left(\frac{F_{\mathcal{R}}^+(z)}{\omega-z} \right)^n \frac{dz}{\omega-z},$$

is analytic for $|\lambda| < \Lambda'$. Similarly, the function

$$Q(\lambda) \equiv \oint_{|\omega-z|=\rho'} F_\lambda^+(z) dz = \sum_{n=0}^{\infty} \lambda^{2n} \oint_{|\omega-z|=\rho'} \left(\frac{F_{\mathcal{R}}^+(z)}{\omega-z} \right)^n \frac{dz}{\omega-z}, \quad (41)$$

is analytic and non-zero for $|\lambda| < \Lambda'$. Since

$$\omega(\lambda) = \frac{P(\lambda)}{Q(\lambda)},$$

we see that $\omega(\lambda)$ is analytic for $|\lambda| < \Lambda$ with the power series expansion

$$\omega(\lambda) = \sum_{n=0}^{\infty} \lambda^{2n} a_{2n}.$$

Obviously, $a_0 = \omega$ and

$$a_2 = -\frac{1}{2\pi i} \oint_{|\omega-z|=\rho'} \frac{F_{\mathcal{R}}^+(z)}{z-\omega} dz = -F_{\mathcal{R}}^+(\omega) = -F_{\mathcal{R}}(\omega + i0).$$

The same formula can be obtained by implicit differentiation of

$$\omega - \omega(\lambda) - \lambda^2 F_{\mathcal{R}}^+(\omega(\lambda)) = 0,$$

at $\lambda = 0$. \square

Theorem 10 explains the mechanism of "dissolving" of the embedded eigenvalue ω . The embedded eigenvalue ω has moved from the real axis to a point $\omega(\lambda)$ on the second (improperly called "unphysical") Riemann sheet of the function $F_\lambda(z)$. There it remains the singularity of the analytically continued resolvent matrix element $(1|(h_\lambda - z)^{-1}1)$, see Figure 1.

We now turn to the physically important concept of the life-time of the embedded eigenvalue.

Theorem 11. *There exists $\Lambda'' > 0$ such that for $|\lambda| < \Lambda''$ and all $t \geq 0$*

$$(1|e^{-it h_\lambda} 1) = e^{-it\omega(\lambda)} + O(\lambda^2).$$

Proof. By Theorem 7 the spectrum of h_λ is purely absolutely continuous for $0 < |\lambda| < \Lambda$. Hence, by Theorem 1,

$$d\mu^\lambda(x) = d\mu_{\text{ac}}^\lambda(x) = \frac{1}{\pi} \text{Im} F_\lambda(x + i0) dx = \frac{1}{\pi} \text{Im} F_\lambda^+(x) dx.$$

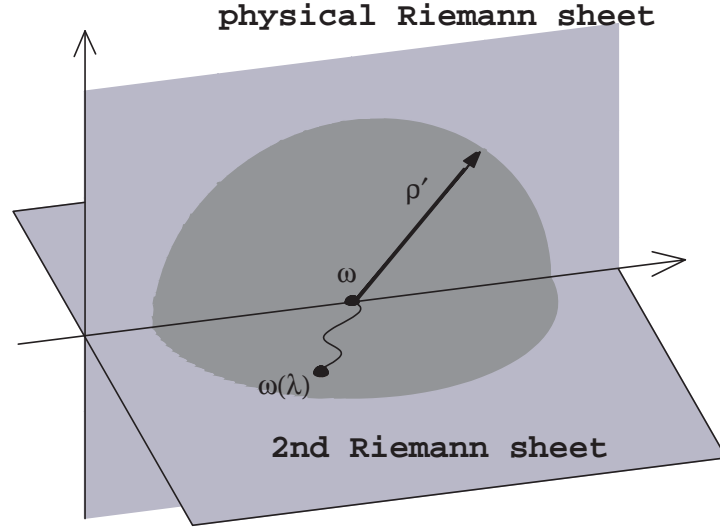

Fig. 1. The resonance pole $\omega(\lambda)$.

Let A' and ρ' be the constants in Theorem 10, $A'' \equiv \min(A', A)$, and suppose that $0 < |\lambda| < A''$. We split the integral representation

$$(1|e^{-ith_\lambda 1}) = \int_X e^{-itx} d\mu^\lambda(x), \quad (42)$$

into three parts as

$$\int_{e_-}^{\omega-\rho'} + \int_{\omega-\rho'}^{\omega+\rho'} + \int_{\omega+\rho'}^{e_+}.$$

Equ. (8) yields

$$\text{Im } F_\lambda^+(x) = \lambda^2 \frac{\text{Im } F_{\mathcal{R}}^+(x)}{|\omega - x - \lambda^2 F_{\mathcal{R}}^+(x)|^2},$$

and so the first and the third term can be estimated as $O(\lambda^2)$. The second term can be written as

$$I(t) \equiv \frac{1}{2\pi i} \int_{\omega-\rho'}^{\omega+\rho'} e^{-itx} \left(F_\lambda^+(x) - \overline{F_\lambda^+(x)} \right) dx.$$

The function $z \mapsto \overline{F_\lambda^+(\bar{z})}$ is meromorphic in an open set containing $D(\omega, \rho)$ with only singularity at $\omega(\lambda)$. We thus have

$$I(t) = -R(\lambda) e^{-it\omega(\lambda)} + \int_\gamma e^{-itz} \left(F_\lambda^+(z) - \overline{F_\lambda^+(\bar{z})} \right) dz,$$

where the half-circle $\gamma = \{z \mid |z - \omega| = \rho', \text{Im } z \leq 0\}$ is positively oriented and

$$R(\lambda) = \operatorname{Res}_{z=\omega(\lambda)} F_\lambda^+(z).$$

By Equ. (41), $R(\lambda) = Q(\lambda)/2\pi i$ is analytic for $|\lambda| < A''$ and

$$R(\lambda) = -1 + O(\lambda^2).$$

Equ. (8) yields that for $z \in \gamma$

$$F_\lambda^+(z) = \frac{1}{\omega - z} + O(\lambda^2).$$

Since ω is real, this estimate yields

$$F_\lambda^+(z) - \overline{F_\lambda^+(\bar{z})} = O(\lambda^2).$$

Combining the estimates we derive the statement. \square

If a quantum mechanical system, described by the Hilbert space \mathfrak{h} and the Hamiltonian h_λ , is initially in a pure state described by the vector 1 , then

$$P(t) = |(1|e^{-it h_\lambda} 1)|^2,$$

is the probability that the system will be in the same state at time t . Since the spectrum of h_λ is purely absolutely continuous, by the Riemann-Lebesgue lemma $\lim_{t \rightarrow \infty} P(t) = 0$. On physical grounds one often expects more, namely an approximate relation

$$P(t) \sim e^{-t\Gamma(\lambda)}, \quad (43)$$

where $\Gamma(\lambda)$ is the so-called radiative life-time of the state 1 . The strict exponential decay $P(t) = O(e^{-at})$ is possible only if $X = \mathbb{R}$. Since in a typical physical situation $X \neq \mathbb{R}$, the relation (43) is expected to hold on an intermediate time scale (for times which are not "too long" or "too short"). Theorem 11 is a mathematically rigorous version of these heuristic claims and $\Gamma(\lambda) = -2 \operatorname{Im} \omega(\lambda)$. The computation of the radiative life-time is of paramount importance in quantum mechanics and the reader may consult standard references [CDG, He, Mes] for additional information.

3.3 Complex deformations

In this subsection we will discuss Assumption (A4) and the perturbation theory of the embedded eigenvalue in some specific situations.

Example 1. In this example we consider the case $X =]0, \infty[$.

Let $0 < \delta < \pi/2$ and $\mathcal{A}(\delta) = \{z \in \mathbb{C} \mid \operatorname{Re} z > 0, |\operatorname{Arg} z| < \delta\}$. We denote by $H_d^2(\delta)$ the class of all functions $f : X \rightarrow \mathfrak{K}$ which have an analytic continuation to the sector $\mathcal{A}(\delta)$ such that

$$\|f\|_\delta^2 = \sup_{|\theta| < \delta} \int_X \|f(e^{i\theta} x)\|_{\mathfrak{K}}^2 dx < \infty.$$

The class $H_d^2(\delta)$ is a Hilbert space. The functions in $H_d^2(\delta)$ are sometimes called *dilation analytic*.

Proposition 8. *Assume that $f \in H_{\mathbb{d}}^2(\delta)$. Then Assumption (A4) holds in the following stronger form:*

1. *The function $F_{\mathcal{R}}(z)$ has an analytic continuation to the region $\mathbb{C}_+ \cup \mathcal{A}(\delta)$. We denote the extended function by $F_{\mathcal{R}}^+(z)$.*
2. *For $0 < \delta' < \delta$ and $\epsilon > 0$ one has*

$$\sup_{|z| > \epsilon, z \in \mathcal{A}(\delta')} |F_{\mathcal{R}}^+(z)| < \infty.$$

Proof. The proposition follows from the representation

$$F_{\mathcal{R}}(z) = \int_X \frac{\|f(x)\|_{\mathfrak{K}}^2}{x-z} dx = e^{i\theta} \int_X \frac{(f(e^{-i\theta}x)|f(e^{i\theta}x))_{\mathfrak{K}}}{e^{i\theta}x-z} dx, \quad (44)$$

which holds for $\text{Im } z > 0$ and $-\delta < \theta \leq 0$. This representation can be proven as follows.

Let $\gamma(\theta)$ be the half-line $e^{i\theta}\mathbb{R}_+$. We wish to prove that for $\text{Im } z > 0$

$$\int_X \frac{\|f(x)\|_{\mathfrak{K}}^2}{x-z} dx = \int_{\gamma(\theta)} \frac{(f(\bar{w})|f(w))_{\mathfrak{K}}}{w-z} dw.$$

To justify the interchange of the line of integration, it suffices to show that

$$\lim_{n \rightarrow \infty} r_n \int_{\theta}^0 \frac{|(f(r_n e^{-i\varphi})|f(r_n e^{i\varphi}))_{\mathfrak{K}}|}{|r_n e^{i\varphi} - z|} d\varphi = 0,$$

along some sequence $r_n \rightarrow \infty$. This fact follows from the estimate

$$\int_X \left[\int_{\theta}^0 \frac{x |(f(e^{-i\varphi}x)|f(e^{i\varphi}x))_{\mathfrak{K}}|}{|e^{i\varphi}x - z|} d\varphi \right] dx \leq C_z \|f\|_{\delta}^2.$$

□

Until the end of this example we assume that $f \in H_{\mathbb{d}}^2(\delta)$ and that Assumption (A2) holds (this is the case, for example, if $f' \in H_{\mathbb{d}}^2(\delta)$ and $f(0) = 0$). Then, Theorems 10 and 11 hold in the following stronger forms.

Theorem 12. *1. The function*

$$F_{\lambda}(z) = (1|(h_{\lambda} - z)^{-1}1),$$

has a meromorphic continuation from \mathbb{C}_+ to the region $\mathbb{C}_+ \cup \mathcal{A}(\delta)$. We denote this continuation by $F_{\lambda}^+(z)$.

2. *Let $0 < \delta' < \delta$ be given. Then there is $\Lambda' > 0$ such that for $|\lambda| < \Lambda'$ the only singularity of $F_{\lambda}^+(z)$ in $\mathcal{A}(\delta')$ is a simple pole at $\omega(\lambda)$. The function $\lambda \mapsto \omega(\lambda)$ is analytic for $|\lambda| < \Lambda'$ and*

$$\omega(\lambda) = \omega + \lambda^2 a_2 + O(\lambda^4),$$

where $a_2 = -F_{\mathcal{R}}(\omega + i0)$. In particular, $\text{Im } a_2 = -\pi \|f(\omega)\|_{\mathfrak{K}}^2 < 0$.

Theorem 13. *There exists $A'' > 0$ such that for $|\lambda| < A''$ and all $t \geq 0$,*

$$(1|e^{-ith\lambda}1) = e^{-it\omega(\lambda)} + O(\lambda^2 t^{-1}).$$

The proof of Theorem 13 starts with the identity

$$(1|e^{-ith\lambda}1) = \lambda^2 \int_X e^{-itx} \|f(x)\|_{\mathfrak{R}}^2 |F_\lambda^+(x)|^2 dx.$$

Given $0 < \delta' < \delta$ one can find A'' such that for $|\lambda| < A''$

$$(1|e^{-ith\lambda}1) = e^{-it\omega(\lambda)} + \lambda^2 \int_{e^{-i\delta'}\mathbb{R}_+} e^{-itw} (f(\bar{w})|f(w))_{\mathfrak{R}} \overline{F_\lambda^+(\bar{w})} F_\lambda^+(w) dw, \quad (45)$$

and the integral on the right is easily estimated by $O(t^{-1})$. We leave the details of the proof as an exercise for the reader.

Example 2. We will use the structure of the previous example to illustrate the complex deformation method in study of resonances. In this example we assume that $f \in H_d^2(\delta)$.

We define a group $\{u(\theta) \mid \theta \in \mathbb{R}\}$ of unitaries on \mathfrak{h} by

$$u(\theta) : \alpha \oplus f(x) \mapsto \alpha \oplus e^{\theta/2} f(e^\theta x).$$

Note that $h_{\mathcal{R}}(\theta) \equiv u(-\theta)h_{\mathcal{R}}u(\theta)$ is the operator of multiplication by $e^{-\theta}x$. Set $h_0(\theta) = \omega \oplus h_{\mathcal{R}}(\theta)$, $f_\theta(x) = u(-\theta)f(x)u(\theta) = f(e^{-\theta}x)$, and

$$h_\lambda(\theta) = h_0(\theta) + \lambda((1|\cdot)f_\theta + (f_\theta|\cdot)1).$$

Clearly, $h_\lambda(\theta) = u(-\theta)h_\lambda u(\theta)$.

We set $S(\delta) \equiv \{z \mid |\operatorname{Im} z| < \delta\}$ and note that the operator $h_0(\theta)$ and the function f_θ are defined for all $\theta \in S(\delta)$. We define $h_\lambda(\theta)$ for $\lambda \in \mathbb{C}$ and $\theta \in S(\delta)$ by

$$h_\lambda(\theta) = h_0(\theta) + \lambda((1|\cdot)f_\theta + (f_\theta|\cdot)1).$$

The operators $h_\lambda(\theta)$ are called dilated Hamiltonians. The basic properties of this family of operators are:

1. $\operatorname{Dom}(h_\lambda(\theta))$ is independent of λ and θ and equal to $\operatorname{Dom}(h_0)$.
2. For all $\phi \in \operatorname{Dom}(h_0)$ the function $\mathbb{C} \times S(\delta) \ni (\lambda, \theta) \mapsto h_\lambda(\theta)\phi$ is analytic in each variable separately.

A family of operators which satisfy (1) and (2) is called an *analytic family of type A* in each variable separately.

3. If $\operatorname{Im} \theta = \operatorname{Im} \theta'$, then the operators $h_\lambda(\theta)$ and $h_\lambda(\theta')$ are unitarily equivalent, namely

$$h_0(\theta') = u(-(\theta' - \theta))h_0(\theta)u(\theta' - \theta).$$

4. $\operatorname{sp}_{\text{ess}}(h_0(\theta)) = e^{-\theta}\mathbb{R}_+$ and $\operatorname{sp}_{\text{disc}}(h_0(\theta)) = \{\omega\}$, see Figure 2.

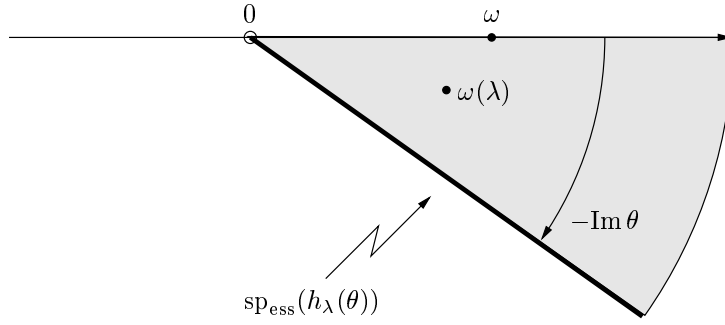

Fig. 2. The spectrum of the dilated Hamiltonian $h_\lambda(\theta)$.

The important aspect of (4) is that while ω is an embedded eigenvalue of h_0 , it is an isolated eigenvalue of $h_0(\theta)$ as soon as $\text{Im } \theta < 0$. Hence, if $\text{Im } \theta < 0$, then the regular perturbation theory can be applied to the isolated eigenvalue ω . Clearly, for all λ , $\text{sp}_{\text{ess}}(h_\lambda(\theta)) = \text{sp}(h_0(\theta))$ and one easily shows that for λ small enough $\text{sp}_{\text{disc}}(h_\lambda(\theta)) = \{\tilde{\omega}(\lambda)\}$ (see Figure 2). Moreover, if $0 < \rho < \min\{\omega, \omega \tan \theta\}$, then for sufficiently small λ ,

$$\tilde{\omega}(\lambda) = \frac{\oint_{|z-\omega|=\rho} z(1|(h_\lambda(\theta) - z)^{-1}1) dz}{\oint_{|z-\omega|=\rho} (1|(h_\lambda(\theta) - z)^{-1}1) dz}.$$

The reader should not be surprised that the eigenvalue $\tilde{\omega}(\lambda)$ is precisely the pole $\omega(\lambda)$ of $F_\lambda^+(z)$ discussed in Theorem 10 (in particular, $\tilde{\omega}(\lambda)$ is independent of θ). To clarify this connection, note that $u(\theta)1 = 1$. Thus, for real θ and $\text{Im } z > 0$,

$$F_\lambda(z) = (1|(h_\lambda - z)^{-1}1) = (1|(h_\lambda(\theta) - z)^{-1}1).$$

On the other hand, the function $\mathbb{R} \ni \theta \mapsto (1|h_\lambda(\theta) - z)^{-1}1$ has an analytic continuation to the strip $-\delta < \text{Im } \theta < \text{Im } z$. This analytic continuation is a constant function, and so

$$F_\lambda^+(z) = (1|h_\lambda(\theta) - z)^{-1}1),$$

for $-\delta < \text{Im } \theta < 0$ and $z \in \mathbb{C}_+ \cup \mathcal{A}(|\text{Im } \theta|)$. This yields that $\omega(\lambda) = \tilde{\omega}(\lambda)$.

The above set of ideas plays a very important role in mathematical physics. For additional information and historical perspective we refer the reader to [AC, BC, CFKS, Der2, Si2, RS4].

Example 3. In this example we consider the case $X = \mathbb{R}$.

Let $\delta > 0$. We denote by $H_t^2(\delta)$ the class of all functions $f : X \rightarrow \mathfrak{K}$ which have an analytic continuation to the strip $S(\delta)$ such that

$$\|f\|_\delta^2 \equiv \sup_{|\theta| < \delta} \int_X \|f(x + i\theta)\|_{\mathfrak{K}}^2 dx < \infty.$$

The class $H_t^2(\delta)$ is a Hilbert space. The functions in $H_t^2(\delta)$ are sometimes called *translation analytic*.

Proposition 9. *Assume that $f \in H_t^2(\delta)$. Then the function $F_{\mathcal{R}}(z)$ has an analytic continuation to the half-plane $\{z \in \mathbb{C} \mid \text{Im } z > -\delta\}$.*

The proposition follows from the relation

$$F_{\mathcal{R}}(z) = \int_X \frac{\|f(x)\|_{\mathbb{R}}^2}{x-z} dx = \int_X \frac{(f(x-i\theta)|f(x+i\theta))_{\mathbb{R}}}{x+i\theta-z} dx, \quad (46)$$

which holds for $\text{Im } z > 0$ and $-\delta < \theta \leq 0$. The proof of (46) is similar to the proof of (44).

Until the end of this example we will assume that $f \in H_t^2(\delta)$. A change of the line of integration yields that the function

$$g(t) = \int_{\mathbb{R}} e^{-itx} \|f(x)\|_{\mathbb{R}}^2 dx,$$

satisfies the estimate $|g(t)| \leq e^{-\delta|t|} \|f\|_{\delta}^2$, and so Assumption (A2) holds. Moreover, Theorems 10 and 11 hold in the following stronger forms.

Theorem 14. *1. The function*

$$F_{\lambda}(z) = (1|(h_{\lambda} - z)^{-1}1),$$

has a meromorphic continuation from \mathbb{C}_+ to the half-plane

$$\{z \in \mathbb{C} \mid \text{Im } z > -\delta\}.$$

We denote this continuation by $F_{\lambda}^+(z)$.

2. Let $0 < \delta' < \delta$ be given. Then there is $\Lambda' > 0$ such that for $|\lambda| < \Lambda'$ the only singularity of $F_{\lambda}^+(z)$ in $\{z \in \mathbb{C} \mid \text{Im } z > -\delta'\}$ is a simple pole at $\omega(\lambda)$. $\omega(\lambda)$ is analytic for $|\lambda| < \Lambda'$ and

$$\omega(\lambda) = \omega + \lambda^2 a_2 + O(\lambda^4),$$

where $a_2 = -F_{\mathcal{R}}(\omega + i0)$. In particular, $\text{Im } a_2 = -\pi \|f(\omega)\|_{\mathbb{R}}^2 < 0$.

Theorem 15. *Let $0 < \delta' < \delta$ be given. Then there exists $\Lambda'' > 0$ such that for $|\lambda| < \Lambda''$ and all $t \geq 0$*

$$(1|e^{-ith_{\lambda}}1) = e^{-it\omega(\lambda)} + O(\lambda^2 e^{-\delta't}).$$

In this example the survival probability has strict exponential decay.

We would like to mention two well-known models in mathematical physics for which analogs of Theorems 14 and 15 holds. The first model is the Stark Hamiltonian which describes charged quantum particle moving under the influence of a

constant electric field [Her]. The second model is the spin-boson system at positive temperature [JP1, JP2].

In the translation analytic case, one can repeat the discussion of the previous example with the analytic family of operators

$$h_\lambda(\theta) = \omega \oplus (x + \theta) + \lambda \left((1|\cdot) f_\theta + (f_\theta|\cdot) 1 \right),$$

where $f_\theta(x) \equiv f(x + \theta)$ (see Figure 3). Note that in this case

$$\text{sp}_{\text{ess}}(h_\lambda(\theta)) = \text{sp}_{\text{ess}}(h_0(\theta)) = \mathbb{R} + i \text{Im } \theta.$$

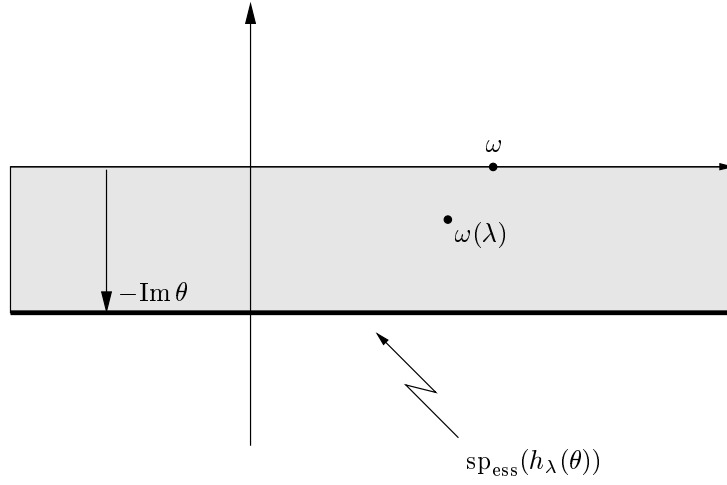

Fig. 3. The spectrum of the translated Hamiltonian $h_\lambda(\theta)$.

Example 4. Let us consider the model described in Example 2 of Subsection 3.1 where $f \in \ell^2(\mathbb{Z}_+)$ has bounded support. In this case $X =]-1, 1[$ and

$$F_{\mathcal{R}}(z) = \int_{-1}^1 \frac{\sqrt{1-x^2}}{x-z} P_f(x) dx, \quad (47)$$

where $P_f(x)$ is a polynomial in x . Since the integrand is analytic in the cut plane $\mathbb{C} \setminus \{x \in \mathbb{R} \mid |x| \geq 1\}$, we can deform the path of integration to any curve γ joining -1 to 1 and lying entirely in the lower half-plane (see Figure 4). This shows that the function $F_{\mathcal{R}}(z)$ has an analytic continuation from \mathbb{C}_+ to the entire cut plane $\mathbb{C} \setminus \{x \in \mathbb{R} \mid |x| \geq 1\}$. Assumption (A4) holds in this case.

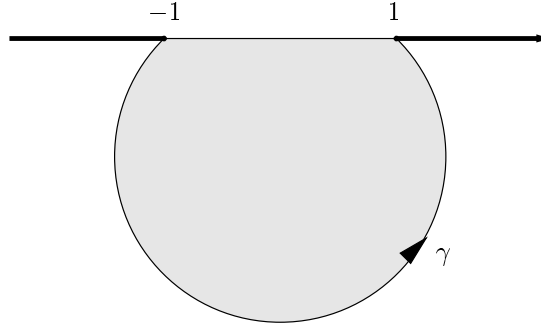

Fig. 4. Deforming the integration contour in Equ. (47).

3.4 Weak coupling limit

The first computation of the radiative life-time in quantum mechanics goes back to the seminal papers of Dirac [Di] and Wigner and Weisskopf [WW]. Consider the survival probability $P(t)$ and assume that $P(t) \sim e^{-t\Gamma(\lambda)}$ where $\Gamma(\lambda) = \lambda^2\Gamma_2 + O(\lambda^3)$ for λ small. To compute the first non-trivial coefficient Γ_2 , Dirac devised a computational scheme called time-dependent perturbation theory. Dirac's formula for Γ_2 was called *Golden Rule* in Fermi's lectures [Fer], and since then this formula is known as *Fermi's Golden Rule*.

One possible mathematically rigorous approach to time-dependent perturbation theory is the so-called weak coupling (or Van Hove) limit. The idea is to study $P(t/\lambda^2)$ as $\lambda \rightarrow 0$. Under very general conditions one can prove that

$$\lim_{\lambda \rightarrow 0} P(t/\lambda^2) = e^{-t\Gamma_2},$$

and that Γ_2 is given by Dirac's formula (see [Da2, Da3]).

In this section we will discuss the weak coupling limit for the RWWA. We will prove:

Theorem 16. *Suppose that Assumptions (A1)-(A3) hold. Then*

$$\lim_{\lambda \rightarrow 0} \left| (1|e^{-ith_\lambda/\lambda^2} 1) - e^{-it\omega/\lambda^2} e^{itF_{\mathcal{R}}(\omega+i0)} \right| = 0,$$

for any $t \geq 0$. In particular,

$$\lim_{\lambda \rightarrow 0} |(1|e^{-ith_\lambda/\lambda^2} 1)|^2 = e^{-2\pi\|f(\omega)\|_{\mathbb{R}}^2 t}.$$

Remark. If in addition Assumption (A4) holds, then Theorem 16 is an immediate consequence of Theorem 11. The point is that the leading contribution to the life-time can be rigorously derived under much weaker regularity assumptions.

Lemma 3. *Suppose that Assumptions (A1)-(A3) hold. Let u be a bounded continuous function on \overline{X} . Then*

$$\lim_{\lambda \rightarrow 0} \left| \lambda^2 \int_X e^{-itx/\lambda^2} u(x) |F_\lambda(x + i0)|^2 dx - \frac{u(\omega)}{\|f(\omega)\|_{\mathfrak{R}}^2} e^{-it(\omega/\lambda^2 - F_{\mathcal{R}}(\omega + i0))} \right| = 0,$$

for any $t \geq 0$.

Proof. We set $h_\omega(x) \equiv |\omega - x - \lambda^2 F_{\mathcal{R}}(\omega + i0)|^{-2}$ and

$$I_\lambda(t) \equiv \lambda^2 \int_X e^{-itx/\lambda^2} u(x) |F_\lambda(x + i0)|^2 dx.$$

We write $u(x) |F_\lambda(x + i0)|^2$ as

$$u(\omega) h_\omega(x) + (u(x) - u(\omega)) h_\omega(x) + u(x) (|F_\lambda(x + i0)|^2 - h_\omega(x)),$$

and decompose $I_\lambda(t)$ into three corresponding pieces $I_{k,\lambda}(t)$. The first piece is

$$I_{1,\lambda}(t) = \lambda^2 u(\omega) \int_{e_-}^{e_+} \frac{e^{-itx/\lambda^2}}{(\omega - x - \lambda^2 \operatorname{Re} F_{\mathcal{R}}(\omega + i0))^2 + (\lambda^2 \operatorname{Im} F_{\mathcal{R}}(\omega + i0))^2} dx.$$

The change of variable

$$y = \frac{x - \omega + \lambda^2 \operatorname{Re} F_{\mathcal{R}}(\omega + i0)}{\lambda^2 \operatorname{Im} F_{\mathcal{R}}(\omega + i0)},$$

and the relation $\operatorname{Im} F_{\mathcal{R}}(\omega + i0) = \pi \|f(\omega)\|_{\mathfrak{R}}^2$ yield that

$$I_{1,\lambda}(t) = e^{-it(\omega/\lambda^2 - \operatorname{Re} F_{\mathcal{R}}(\omega + i0))} \frac{u(\omega)}{\|f(\omega)\|_{\mathfrak{R}}^2} \frac{1}{\pi} \int_{e_-(\lambda)}^{e_+(\lambda)} \frac{e^{-it \operatorname{Im} F_{\mathcal{R}}(\omega + i0) y}}{y^2 + 1} dy,$$

where

$$e_\pm(\lambda) \equiv \lambda^{-2} \frac{e_\pm - \omega}{\pi \|f(\omega)\|_{\mathfrak{R}}^2} + \frac{\operatorname{Re} F_{\mathcal{R}}(\omega + i0)}{\pi \|f(\omega)\|_{\mathfrak{R}}^2} \rightarrow \pm\infty,$$

as $\lambda \downarrow 0$. From the formula

$$\frac{1}{\pi} \int_{-\infty}^{\infty} \frac{e^{-it \operatorname{Im} F_{\mathcal{R}}(\omega + i0) y}}{y^2 + 1} dy = e^{-t \operatorname{Im} F_{\mathcal{R}}(\omega + i0)},$$

we obtain that

$$I_{1,\lambda}(t) = \frac{u(\omega)}{\|f(\omega)\|_{\mathfrak{R}}^2} e^{-it(\omega/\lambda^2 - F_{\mathcal{R}}(\omega + i0))} (1 + o(1)), \quad (48)$$

as $\lambda \downarrow 0$.

Using the boundedness and continuity properties of u and h_ω , one easily shows that the second and the third piece can be estimated as

$$\begin{aligned} |I_{2,\lambda}(t)| &\leq \lambda^2 \int_X |u(x) - u(\omega)| h_\omega(x) dx, \\ |I_{3,\lambda}(t)| &\leq \lambda^2 \int_X |u(x)| \left| |F_\lambda(x + i0)|^2 - h_\omega(x) \right| dx. \end{aligned}$$

Hence, they vanish as $\lambda \downarrow 0$, and the result follows from Equ. (48). \square

Proof of Theorem 16. Let Λ be as in Proposition 7. Recall that for $0 < |\lambda| < \Lambda$ the spectrum of h_λ is purely absolutely continuous. Hence, for λ small,

$$\begin{aligned} (1|e^{-ith_\lambda/\lambda^2}1) &= \frac{1}{\pi} \int_X e^{-itx/\lambda^2} \operatorname{Im} F_\lambda(x + i0) dx \\ &= \frac{1}{\pi} \int_X e^{-itx/\lambda^2} |F_\lambda(x + i0)|^2 \operatorname{Im} F_{\mathcal{R}}(x + i0) dx \\ &= \lambda^2 \int_X e^{-itx/\lambda^2} \|f(x)\|_{\mathbb{R}}^2 |F_\lambda(x + i0)|^2 dx, \end{aligned}$$

where we used Equ. (19). This formula and Lemma 3 yield Theorem 16. \square

The next result we wish to discuss concerns the weak coupling limit for the form of the emitted wave. Let $p_{\mathcal{R}}$ be the orthogonal projection on the subspace $\mathfrak{h}_{\mathcal{R}}$ of \mathfrak{h} .

Theorem 17. For any $g \in C_0(\mathbb{R})$,

$$\lim_{\lambda \downarrow 0} (p_{\mathcal{R}} e^{-ith_\lambda/\lambda^2} 1 | g(h_{\mathcal{R}}) p_{\mathcal{R}} e^{-ith_\lambda/\lambda^2} 1) = g(\omega) \left(1 - e^{-2\pi \|f(\omega)\|_{\mathbb{R}}^2 t} \right). \quad (49)$$

Proof. Using the decomposition

$$\begin{aligned} p_{\mathcal{R}} g(h_{\mathcal{R}}) p_{\mathcal{R}} &= (p_{\mathcal{R}} g(h_{\mathcal{R}}) p_{\mathcal{R}} - g(h_0)) + (g(h_0) - g(h_\lambda)) + g(h_\lambda) \\ &= -g(\omega)(1|\cdot)1 + (g(h_0) - g(h_\lambda)) + g(h_\lambda), \end{aligned}$$

we can rewrite $(p_{\mathcal{R}} e^{-ith_\lambda/\lambda^2} 1 | g(h_{\mathcal{R}}) p_{\mathcal{R}} e^{-ith_\lambda/\lambda^2} 1)$ as a sum of three pieces. The first piece is equal to

$$-g(\omega) |(1|e^{-ith_\lambda/\lambda^2}1)|^2 = -g(\omega) e^{-2\pi \|f(\omega)\|_{\mathbb{R}}^2 t}. \quad (50)$$

Since $\lambda \mapsto h_\lambda$ is continuous in the norm resolvent sense, we have

$$\lim_{\lambda \rightarrow 0} \|g(h_\lambda) - g(h_0)\| = 0,$$

and the second piece can be estimated

$$(e^{-ith_\lambda/\lambda^2} 1 | (g(h_0) - g(h_\lambda)) e^{-ith_\lambda/\lambda^2} 1) = o(1), \quad (51)$$

as $\lambda \downarrow 0$. The third piece satisfies

$$\begin{aligned} (e^{-ith_\lambda/\lambda^2} 1 | g(h_\lambda) e^{-ith_\lambda/\lambda^2} 1) &= (1|g(h_\lambda)1) \\ &= (1|g(h_0)1) + (1|(g(h_\lambda) - g(h_0))1) \\ &= g(\omega) + o(1), \end{aligned} \quad (52)$$

as $\lambda \downarrow 0$. Equ. (50), (51) and (52) yield the statement. \square

Needless to say, Theorems 16 and 17 can be also derived from the general theory of weak coupling limit developed in [Da2, Da3]. For additional information about the weak coupling limit we refer the reader to [Da2, Da3, Der3, FGP, Haa, VH].

3.5 Examples

In this subsection we describe the meromorphic continuation of

$$F_\lambda(z) = (1|(h_\lambda - z)^{-1}1),$$

across $\text{sp}_{\text{ac}}(h_\lambda)$ in some specific examples which allow for explicit computations. Since $F_\lambda(z) = F_{-\lambda}(z)$, we need to consider only $\lambda \geq 0$.

Example 1. Let $X =]0, \infty[$ and

$$f(x) \equiv \pi^{-1/2}(2x)^{1/4}(1+x^2)^{-1/2}.$$

Note that $f \in H_{\text{d}}^2(\delta)$ for $0 < \delta < \pi/2$ and so f is dilation analytic. In this specific example, however, one can evaluate $F_{\mathcal{R}}(z)$ directly and describe the full Riemann surface of $F_\lambda(z)$, thus going far beyond the results of Theorem 12.

For $z \in \mathbb{C} \setminus [0, \infty)$ we set $w \equiv \sqrt{-z}$, where the branch is chosen so that $\text{Re } w > 0$. Then $iw \in \mathbb{C}_+$ and the integral

$$F_{\mathcal{R}}(z) = \frac{1}{\pi} \int_0^\infty \frac{\sqrt{2t}}{1+t^2} \frac{dt}{t-z} = \frac{\sqrt{2}}{\pi} \int_{-\infty}^\infty \frac{t^2}{1+t^4} \frac{dt}{t^2+w^2},$$

is easily evaluated by closing the integration path in the upper half-plane and using the residue method. We get

$$F_{\mathcal{R}}(z) = \frac{1}{w^2 + \sqrt{2}w + 1}.$$

Thus $F_{\mathcal{R}}$ is a meromorphic function of w with two simple poles at $w = e^{\pm 3i\pi/4}$. It follows that $F_{\mathcal{R}}(z)$ is meromorphic on the two-sheeted Riemann surface of $\sqrt{-z}$. On the first (physical) sheet, where $\text{Re } w > 0$, it is of course analytic. On the second sheet, where $\text{Re } w < 0$, it has two simple poles at $z = \pm i$.

In term of the uniformizing variable w , we have

$$F_\lambda(z) = \frac{w^2 + \sqrt{2}w + 1}{(w^2 + \omega)(w^2 + \sqrt{2}w + 1) - \lambda^2}.$$

For $\lambda > 0$, this meromorphic function has 4 poles. These poles are analytic functions of λ except at the collision points. For λ small, the poles form two conjugate pairs, one near $\pm i\sqrt{\omega}$, the other near $e^{\pm 3i\pi/4}$. Both pairs are on the second sheet. For λ large, a pair of conjugated poles goes to infinity along the asymptote $\text{Re } w = -\sqrt{2}/4$. A pair of real poles goes to $\pm\infty$. In particular, one of them enters the first sheet at $\lambda = \sqrt{\omega}$ and h_λ has one negative eigenvalue for $\lambda > \sqrt{\omega}$. Since

$$G_{\mathcal{R}}(x) = \frac{1}{\pi} \int_0^\infty \frac{\sqrt{2}}{1+t^2} \frac{dt}{(t-x)^2},$$

is finite for $x < 0$ and infinite for $x \geq 0$, 0 is not an eigenvalue of h_λ for $\lambda = \sqrt{\omega}$, but a zero energy resonance. Note that the image of the asymptote $\text{Re } w = -\sqrt{2}/4$

on the second sheet is the parabola $\{z = x + iy \mid x = 2y^2 - 1/8\}$. Thus, as $\lambda \rightarrow \infty$, the poles of $F_\lambda(z)$ move away from the spectrum. This means that there are no resonances in the large coupling limit.

The qualitative trajectories of the poles (as functions of λ for fixed values of ω) are plotted in Figure 5.

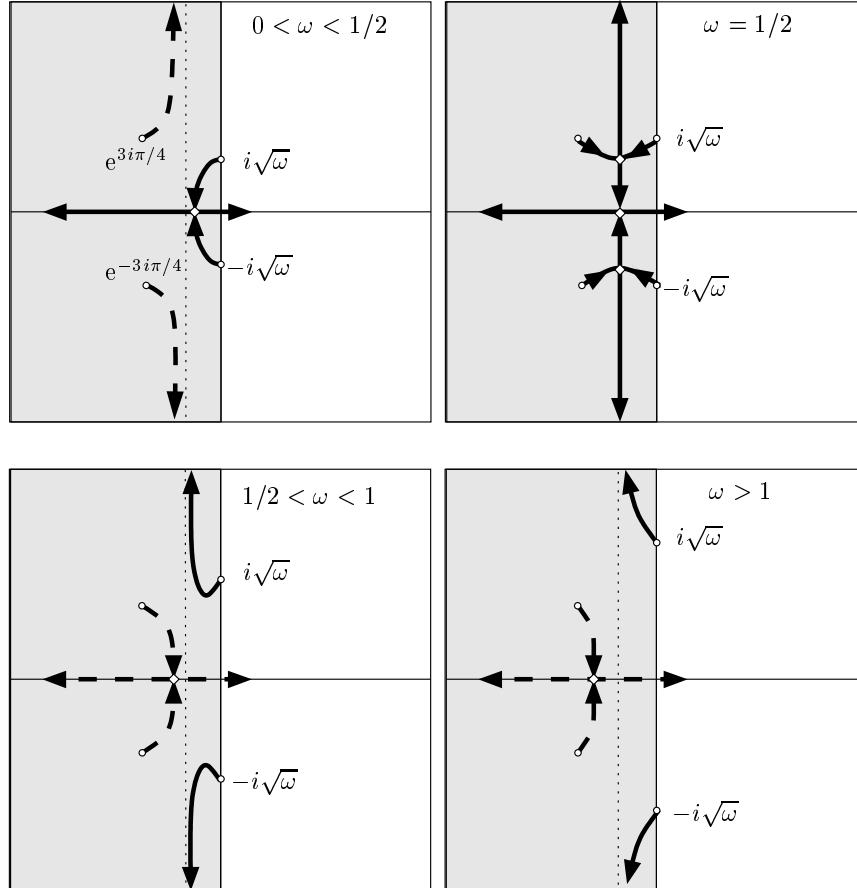

Fig. 5. Trajectories of the poles of $F_\lambda(z)$ in w -space for various values of ω in Example 1. Notice the simultaneous collision of the two pairs of conjugate poles when $\omega = \lambda = 1/2$. The second Riemann sheet is shaded.

Example 2. Let $X = \mathbb{R}$ and

$$f(x) \equiv \pi^{-1/2}(1 + x^2)^{-1/2}.$$

Since $f \in H_t^2(\delta)$ for $0 < \delta < 1$, the function f is translation analytic. Here again we can compute explicitly $F_{\mathcal{R}}(z)$. For $z \in \mathbb{C}_+$, a simple residue calculation leads to

$$F_{\mathcal{R}}(z) = \frac{1}{\pi} \int_{-\infty}^{\infty} \frac{1}{1+t^2} \frac{dt}{t-z} = -\frac{1}{z+i}.$$

Hence,

$$F_{\lambda}(z) = \frac{z+i}{\lambda^2 - (z+i)(z-\omega)},$$

has a meromorphic continuation across the real axis to the entire complex plane. It has two poles given by the two branches of

$$\omega(\lambda) = \frac{\omega - i + \sqrt{(\omega + i)^2 + 4\lambda^2}}{2},$$

which are analytic except at the collision point $\omega = 0, \lambda = 1/2$. For small λ , one of these poles is near ω and the other is near $-i$. Since

$$\omega(\lambda) = -\frac{i}{2} + \left(\frac{\omega}{2} \pm \lambda\right) + O(1/\lambda),$$

as $\lambda \rightarrow \infty, h_{\lambda}$ has no large coupling resonances. The resonance curve $\omega(\lambda)$ is plotted in Figure 6.

Clearly, $\text{sp}(h_{\lambda}) = \mathbb{R}$ for all ω and λ . Note that for all $x \in \mathbb{R}, G_{\mathcal{R}}(x) = \infty$ and

$$\text{Im } F_{\lambda}(x+i0) = \frac{\lambda^2}{(x-\omega)^2 + (\lambda^2 - x(x-\omega))^2}.$$

Hence, the operator h_{λ} has purely absolutely continuous spectrum for all ω and all $\lambda \neq 0$.

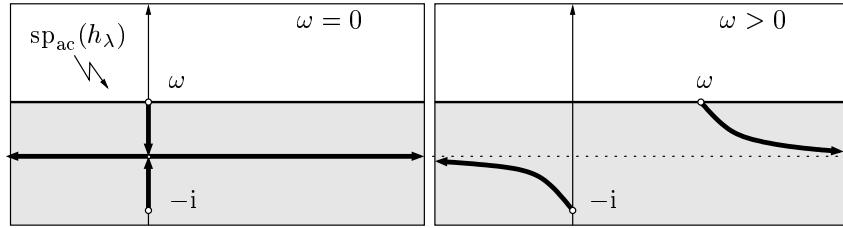

Fig. 6. The poles of $F_{\lambda}(z)$ for Example 2.

Example 3. Let $X =]-1, 1[$ and

$$f(x) \equiv \sqrt{\frac{2}{\pi}} (1-x^2)^{1/4}.$$

(Recall Example 2 in Subsection 3.1 and Example 4 in Subsection 3.3 – $\mathfrak{h}_{\mathcal{R}}$ and $h_{\mathcal{R}}$ are $\ell^2(\mathbb{Z}_+)$ and the discrete Laplacian in the energy representation and $f = \delta_1^{\#}$.) In Subsection 2.9 we have shown that for $z \in \mathbb{C} \setminus [-1, 1]$,

$$F_{\mathcal{R}}(z) = \frac{2}{\pi} \int_{-1}^1 \frac{\sqrt{1-t^2}}{t-z} dt = 2 \frac{\xi-1}{\xi+1}, \quad (53)$$

where

$$\xi = \sqrt{\frac{z-1}{z+1}}.$$

The principal branch of the square root $\operatorname{Re} \xi > 0$ corresponds to the first (physical)

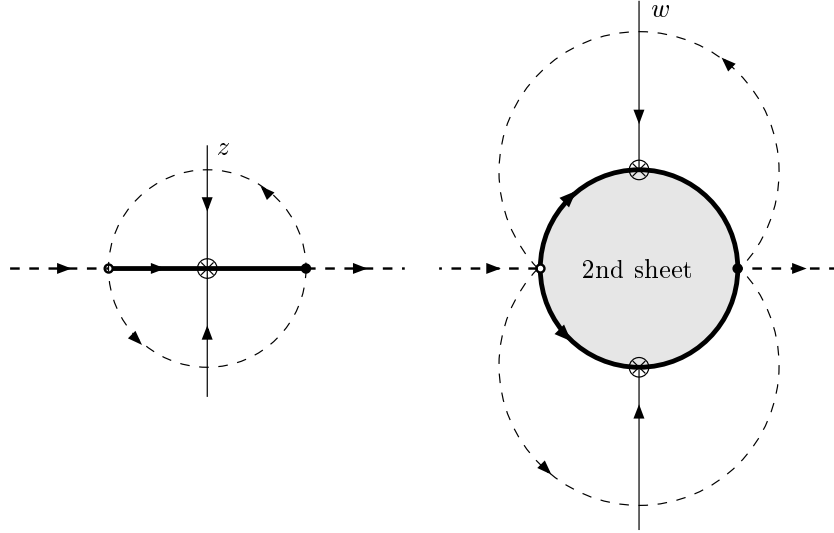

Fig. 7. Mapping the cut plane $\mathbb{C} \setminus [-1, 1]$ to the exterior of the unit disk

sheet of the Riemann surface R of $F_{\mathcal{R}}(z)$. The branch $\operatorname{Re} \xi < 0$ corresponds to the second sheet of R . In particular,

$$F_{\mathcal{R}}(x + i0) = 2(-x + i\sqrt{1-x^2}).$$

For an obvious reason we will call this particular RWWA the semi-circle model. To discuss the analytic structure of the Borel transform $F_{\lambda}(z)$, it is convenient to introduce the uniformizing variable

$$w \equiv -\frac{2}{F_{\mathcal{R}}(z)} = \frac{1+\xi}{1-\xi},$$

which maps the Riemann surface R to $\mathbb{C} \setminus \{0\}$. Note that the first sheet of R is mapped on the exterior of the unit disk and that the second sheet is mapped on the punctured disk $\{z \in \mathbb{C} \mid 0 < |z| < 1\}$ (see Figure 7). The inverse of this map is

$$z = \frac{1}{2} \left(w + \frac{1}{w} \right).$$

For $z \in \mathbb{C} \setminus [-1, 1]$ the function $F_\lambda(z)$ is given by

$$F_\lambda(z) = \frac{-2w}{w^2 - 2\omega w + 1 - 4\lambda^2},$$

and thus has a meromorphic continuation to the entire Riemann surface R . The resonance poles in the w -plane are computed by solving

$$w^2 - 2\omega w + 1 - 4\lambda^2 = 0,$$

and are given by the two-valued analytic function

$$w = \omega + \sqrt{4\lambda^2 + \omega^2 - 1}.$$

We will describe the motion of the poles in the case $\omega \geq 0$ (the case $\omega \leq 0$ is completely symmetric). For $0 < \lambda < \sqrt{1 - \omega^2}/2$ there are two conjugate poles on the second sheet which, in the w -plane, move towards the point ω on a vertical line. After their collision at $\lambda = \sqrt{1 - \omega^2}/2$, they turn into a pair of real poles moving towards $\pm\infty$ (see Figure 8). The pole moving to the right reaches $w = 1$ at $\lambda = \sqrt{(1 - \omega)/2}$ and enters the first sheet of R . We conclude that h_λ has a positive eigenvalue

$$\omega_+(\lambda) = \frac{1}{2} \left(\omega + \sqrt{4\lambda^2 + \omega^2 - 1} + \frac{1}{\omega + \sqrt{4\lambda^2 + \omega^2 - 1}} \right),$$

for $\lambda > \sqrt{(1 - \omega)/2}$. The pole moving to the left reaches $w = 0$ at $\lambda = 1/2$. This means that this pole reaches $z = \infty$ on the second sheet of R . For $\lambda > 1/2$, the pole continues its route towards $w = -1$, *i.e.*, it comes back from $z = \infty$ towards $z = -1$, still on the second sheet of R . At $\lambda = \sqrt{(1 + \omega)/2}$, it reaches $w = -1$ and enters the first sheet. We conclude that h_λ has a negative eigenvalue

$$\omega_-(\lambda) = \frac{1}{2} \left(\omega - \sqrt{4\lambda^2 + \omega^2 - 1} + \frac{1}{\omega - \sqrt{4\lambda^2 + \omega^2 - 1}} \right),$$

for $\lambda > \sqrt{(1 + \omega)/2}$. The trajectory of these poles in the z cut-plane is shown on Figure 9. For clarity, only one pole of the conjugate pair is displayed.

Example 4. In all the previous examples, there were no resonances in the large coupling regime, *i.e.*, the second sheet poles of F_λ kept away from the continuous spectrum as $\lambda \rightarrow \infty$. This fact can be understood as follows. If a resonance $\omega(\lambda)$ approaches the real axis as $\lambda \rightarrow \infty$, then it follows from Equ. (8) that $\text{Im } F_{\mathcal{R}}(\omega(\lambda)) = o(\lambda^{-2})$. Since under Assumptions (A1) and (A2) $F_{\mathcal{R}}$ is continuous on $\overline{\mathbb{C}_+}$, we conclude that if $\lim_{\lambda \rightarrow \infty} \omega(\lambda) = \bar{\omega} \in \mathbb{R}$, then $\text{Im } F_{\mathcal{R}}(\bar{\omega} + i0) = 0$. Since $\|f(x)\|_{\mathfrak{R}}$ is also continuous on \overline{X} , if $\bar{\omega} \in \overline{X}$, then we must have $f(\bar{\omega}) = 0$. Thus the only possible locations of large coupling resonances are the zeros of f in \overline{X} . We finish this subsection with an example where such large coupling resonances exist.

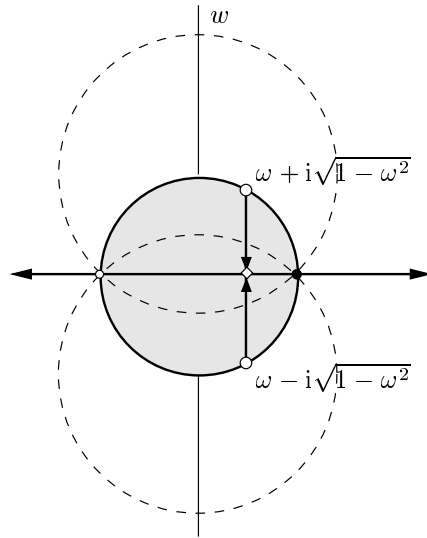

Fig. 8. The trajectories of the poles of F_λ in the w -plane. The second sheet is shaded.

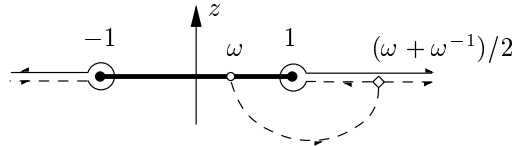

Fig. 9. The trajectories of the poles of F_λ in the z -plane. Dashed lines are on the second sheet.

Let again $X \in]-1, 1[$ and set

$$f(x) \equiv \sqrt{\frac{1}{\pi}} x(1-x^2)^{1/4}.$$

The Borel transform

$$F_{\mathcal{R}}(z) = \frac{1}{\pi} \int_{-1}^1 \frac{x^2 \sqrt{1-x^2}}{x-z} dx,$$

is easily evaluated by a residue calculation and the change of variable

$$x = (u + u^{-1})/2.$$

Using the same uniformizing variable w as in Example 3, we get

$$F_{\mathcal{R}}(z) = -\frac{1}{4} \left(1 + \frac{1}{w^2} \right) \frac{1}{w}, \tag{54}$$

and

$$F_\lambda(z) = \frac{-4w^3}{2w^4 - 4\omega w^3 + (2 - \lambda^2)w^2 - \lambda^2}. \quad (55)$$

We shall again restrict ourselves to the case $0 < \omega < 1$. At $\lambda = 0$ the denominator of (55) has a double zero at $w = 0$ and a pair of conjugated zeros at $\omega \pm i\sqrt{1 - \omega^2}$. As λ increases, the double zero at 0 splits into a pair of real zeros going to $\pm\infty$. The right zero reaches 1 and enters the first sheet at $\lambda = \sqrt{2(1 - \omega)}$. At $\lambda = \sqrt{2(1 + \omega)}$, the left zero reaches -1 and also enters the first sheet. The pair of conjugated zeros move from their original positions towards $\pm i$ (of course, they remain within the unit disk). For large λ , they behave like

$$w = \pm i + \frac{2\omega}{\lambda^2} - \frac{2\omega(2 \pm 5i\omega)}{\lambda^4} + O(\lambda^{-6}).$$

Thus, in the z plane, F_λ has two real poles emerging from $\pm\infty$ on the second sheet and traveling towards ± 1 . The right pole reaches 1 at $\lambda = \sqrt{2(1 - \omega)}$ and becomes an eigenvalue of h_λ which returns to $+\infty$ as λ further increases. The left pole reaches -1 at $\lambda = \sqrt{2(1 + \omega)}$, becomes an eigenvalue of h_λ , and further proceeds towards $-\infty$. On the other hand, the eigenvalue ω of h_0 turns into a pair of conjugated poles on the second sheet which, as $\lambda \rightarrow \infty$, tend towards 0 as

$$\omega(\lambda) = \frac{2\omega}{\lambda^2} - \frac{4\omega(1 \pm 2i\omega)}{\lambda^4} + O(\lambda^{-6}),$$

see Figure 9. We conclude that h_λ has a large coupling resonance approaching 0 as $\lambda \rightarrow \infty$.

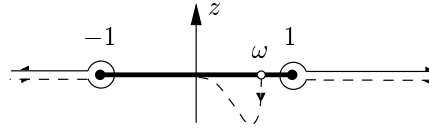

Fig. 10. The trajectories of the poles of F_λ in the z -plane. Dashed lines are on the second sheet.

4 Fermionic quantization

4.1 Basic notions of fermionic quantization

This subsection is a telegraphic review of the fermionic quantization. For additional information and references the reader may consult Section 5 in [AJPP1].

Let \mathfrak{h} be a Hilbert space. We denote by $\Gamma(\mathfrak{h})$ the fermionic (antisymmetric) Fock space over \mathfrak{h} , and by $\Gamma_n(\mathfrak{h})$ the n -particle sector in \mathfrak{h} . $\Phi_{\mathfrak{h}}$ denotes the vacuum in $\Gamma(\mathfrak{h})$ and $a(f), a^*(f)$ the annihilation and creation operators associated to $f \in \mathfrak{h}$. In the

sequent $a^\#(f)$ represents either $a(f)$ or $a^*(f)$. Recall that $\|a^\#(f)\| = \|f\|$. The CAR algebra over \mathfrak{h} , $\text{CAR}(\mathfrak{h})$, is the C^* -algebra of bounded operators on $\Gamma(\mathfrak{h})$ generated by $\{a^\#(f) \mid f \in \mathfrak{h}\}$.

Let u be a unitary operator on \mathfrak{h} . Its second quantization

$$\Gamma(u)|_{\Gamma_n(\mathfrak{h})} \equiv u \otimes \cdots \otimes u = u^{\otimes n},$$

defines a unitary operator on $\Gamma(\mathfrak{h})$ which satisfies

$$\Gamma(u)a^\#(f) = a^\#(uf)\Gamma(u).$$

Let h be a self-adjoint operator on \mathfrak{h} . The second quantization of e^{ith} is a strongly continuous group of unitary operators on $\Gamma(\mathfrak{h})$. The generator of this group is denoted by $d\Gamma(h)$,

$$\Gamma(e^{ith}) = e^{itd\Gamma(h)}.$$

$d\Gamma(h)$ is essentially self-adjoint on $\Gamma(\text{Dom } h)$, where $\text{Dom } h$ is equipped with the graph norm, and one has

$$d\Gamma(h)|_{\Gamma_n(\text{Dom } h)} = \sum_{k=1}^n \underbrace{I \otimes \cdots \otimes I}_{k-1} \otimes h \otimes \underbrace{I \otimes \cdots \otimes I}_{n-k}.$$

The maps

$$\tau^t(a^\#(f)) = e^{itd\Gamma(h)}a^\#(f)e^{-itd\Gamma(h)} = a^\#(e^{ith}f),$$

uniquely extend to a group τ of $*$ -automorphisms of $\text{CAR}(\mathfrak{h})$. τ is often called the group of Bogoliubov automorphisms induced by h . The group τ is norm continuous and the pair $(\text{CAR}(\mathfrak{h}), \tau)$ is a C^* -dynamical system. We will call it a CAR dynamical system. We will also call the pair $(\text{CAR}(\mathfrak{h}), \tau)$ the fermionic quantization of (\mathfrak{h}, h) .

If two pairs (\mathfrak{h}_1, h_1) and (\mathfrak{h}_2, h_2) are unitarily equivalent, that is, if there exists a unitary $u : \mathfrak{h}_1 \rightarrow \mathfrak{h}_2$ such that $uh_1u^{-1} = h_2$, then the fermionic quantizations $(\text{CAR}(\mathfrak{h}_1), \tau_1)$ and $(\text{CAR}(\mathfrak{h}_2), \tau_2)$ are isomorphic—the map $\sigma(a^\#(f)) = a^\#(uf)$ extends uniquely to a $*$ -isomorphism such that $\sigma \circ \tau_1^t = \tau_2^t \circ \sigma$.

4.2 Fermionic quantization of the WWA

Let h_λ be a WWA on $\mathfrak{h} = \mathbb{C} \oplus \mathfrak{h}_{\mathcal{R}}$. Its fermionic quantization is the pair $(\text{CAR}(\mathfrak{h}), \tau_\lambda)$, where

$$\tau_\lambda^t(a^\#(\phi)) = e^{itd\Gamma(h_\lambda)}a^\#(\phi)e^{-itd\Gamma(h_\lambda)} = a^\#(e^{ith_\lambda}\phi).$$

We will refer to $(\text{CAR}(\mathfrak{h}), \tau_\lambda)$ as the *Simple Electronic Black Box* (SEBB) model. This model has been discussed in the recent lecture notes [AJPP1]. The SEBB model is the simplest non-trivial example of the Electronic Black Box model introduced and studied in [AJPP2].

The SEBB model is also the simplest non-trivial example of an open quantum system. Set

$$\tau_S^t(a^\#(\alpha)) = a^\#(e^{it\omega}\alpha), \quad \tau_{\mathcal{R}}^t(a^\#(g)) = a^\#(e^{ith_{\mathcal{R}}}g).$$

The CAR dynamical systems $(\text{CAR}(\mathbb{C}), \tau_S)$ and $(\text{CAR}(\mathfrak{h}_{\mathcal{R}}), \tau_{\mathcal{R}})$ are naturally identified with sub-systems of the non-interacting SEBB $(\text{CAR}(\mathfrak{h}), \tau_0)$. The system $(\text{CAR}(\mathbb{C}), \tau_S)$ is a two-level quantum dot without internal structure. The system $(\text{CAR}(\mathfrak{h}_{\mathcal{R}}), \tau_{\mathcal{R}})$ is a free Fermi gas reservoir. Hence, $(\text{CAR}(\mathfrak{h}_\lambda), \tau_\lambda)$ describes the interaction of a two-level quantum system with a free Fermi gas reservoir.

In the sequel we denote $H_\lambda \equiv d\Gamma(h_\lambda)$, $H_S \equiv d\Gamma(\omega)$, $H_{\mathcal{R}} \equiv d\Gamma(h_{\mathcal{R}})$, and

$$V \equiv d\Gamma(v) = a^*(f)a(1) + a^*(1)a(f).$$

Clearly,

$$H_\lambda = H_0 + \lambda V.$$

4.3 Spectral theory

The vacuum of $\Gamma(\mathfrak{h})$ is always an eigenvector of H_λ with eigenvalue zero. The rest of the spectrum of H_λ is completely determined by the spectrum of h_λ and one may use the results of Sections 2 and 3.2 to characterize the spectrum of H_λ . We mention several obvious facts. If the spectrum of h_λ is purely absolutely continuous, then the spectrum of H_λ is also purely absolutely continuous except for a simple eigenvalue at zero. H_λ has no singular continuous spectrum iff h_λ has no singular continuous spectrum. Let $\{e_i\}_{i \in I}$ be the eigenvalues of h_λ , repeated according to their multiplicities. The eigenvalues of H_λ are given by

$$\text{sp}_p(H_\lambda) = \left\{ \sum_{i \in I} n_i e_i \mid n_i \in \{0, 1\}, \sum_{i \in I} n_i < \infty \right\} \cup \{0\}.$$

Until the end of this subsection we will discuss the fermionic quantization of the Radiating Wigner-Weisskopf Atom introduced in Section 3.2. The point spectrum of H_0 consists of two simple eigenvalues $\{0, \omega\}$. The corresponding normalized eigenfunctions are

$$\Psi_n = a(1)^n \Phi_{\mathfrak{h}}, \quad n = 0, 1.$$

Apart from these simple eigenvalues, the spectrum of H_0 is purely absolutely continuous and $\text{sp}_{ac}(H_0)$ is equal to the closure of the set

$$\left\{ e + \sum_{i=1}^n x_i \mid x_i \in X, e \in \{0, \omega\}, n \geq 1 \right\}.$$

Let Λ be as in Theorem 7. Then for $0 < |\lambda| < \Lambda$ the spectrum of H_λ is purely absolutely continuous except for a simple eigenvalue 0.

Note that

$$\begin{aligned} (\Psi_1 | e^{-itH_\lambda} \Psi_1) &= (a(1)\Phi_{\mathfrak{h}} | e^{-itH_\lambda} a(1)\Phi_{\mathfrak{h}}) \\ &= (a(1)\Phi_{\mathfrak{h}} | a(e^{-ith_\lambda})\Phi_{\mathfrak{h}}) = (1 | e^{-it\omega} 1). \end{aligned}$$

Similarly,

$$(\Psi_1 | (H_\lambda - z)^{-1} \Psi_1) = (1 | (h_\lambda - z)^{-1} 1).$$

Hence, one may use directly the results (and examples) of Section 3 to describe the asymptotic of $(\Psi_1 | e^{-itH_\lambda} \Psi_1)$ and the meromorphic continuation of

$$\mathbb{C}_+ \ni z \mapsto (\Psi_1 | (H_\lambda - z)^{-1} \Psi_1). \quad (56)$$

4.4 Scattering theory

Let h_λ be a WWA on $\mathfrak{h} = \mathbb{C} \oplus \mathfrak{h}_{\mathcal{R}}$. The relation

$$\tau_0^{-t} \circ \tau_\lambda^t(a^\#(\phi)) = a^\#(e^{-ith_0} e^{ith_\lambda} \phi),$$

yields that for $\phi \in \mathfrak{h}_{ac}(h_\lambda)$ the limit

$$\lim_{t \rightarrow \infty} \tau_0^{-t} \circ \tau_\lambda^t(a^\#(\phi)) = a^\#(\Omega_\lambda^- \phi),$$

exists in the norm topology of $\text{CAR}(\mathfrak{h})$. Denote

$$\tau_{\lambda,ac} \equiv \tau_\lambda |_{\text{CAR}(\mathfrak{h}_{ac}(h_\lambda))}, \quad \tau_{\mathcal{R},ac} \equiv \tau_{\mathcal{R}} |_{\text{CAR}(\mathfrak{h}_{ac}(h_{\mathcal{R}}))}.$$

By the intertwining property (25) of the wave operator Ω_λ^- , the map

$$\sigma_\lambda^+(a^\#(\phi)) \equiv a^\#(\Omega_\lambda^- \phi),$$

satisfies $\sigma_\lambda^+ \circ \tau_{\lambda,ac}^t = \tau_{\mathcal{R},ac}^t \circ \sigma_\lambda^+$. Hence, σ_λ^+ is a $*$ -isomorphism between the CAR dynamical systems $(\text{CAR}(\mathfrak{h}_{ac}(h_\lambda)), \tau_{\lambda,ac})$ and $(\text{CAR}(\mathfrak{h}_{ac}(h_{\mathcal{R}})), \tau_{\mathcal{R},ac})$. This isomorphism is the algebraic analog of the wave operator in Hilbert space scattering theory and is often called the Møller isomorphism.

5 Quantum statistical mechanics of the SEBB model

5.1 Quasi-free states

This subsection is a direct continuation of Subsection 4.1. Let \mathfrak{h} be a given Hilbert space and $\text{CAR}(\mathfrak{h})$ the CAR algebra over \mathfrak{h} . A positive linear functional $\eta : \text{CAR}(\mathfrak{h}) \rightarrow \mathbb{C}$ is called a *state* if $\eta(I) = 1$. A physical system \mathcal{P} is described by the CAR dynamical system $(\text{CAR}(\mathfrak{h}), \tau)$ if its physical observables can be identified with elements of $\text{CAR}(\mathfrak{h})$ and if their time evolution is specified by the group τ . The physical states of \mathcal{P} are specified by states on $\text{CAR}(\mathfrak{h})$. If \mathcal{P} is initially in a state described by η and $A \in \text{CAR}(\mathfrak{h})$ is a given observable, then the expectation value of A at time t is $\eta(\tau^t(A))$. This is the usual framework of the algebraic quantum statistical mechanics in the Heisenberg picture. In the Schrödinger picture one evolves the states and keeps the observables fixed, *i.e.*, if η is an initial state, then the state

at time t is $\eta \circ \tau^t$. A state η is called τ -invariant (or stationary state, steady state) if $\eta \circ \tau^t = \eta$ for all t .

Let T be a self-adjoint operator on \mathfrak{h} such that $0 \leq T \leq I$. The map

$$\eta_T(a^*(f_n) \cdots a^*(f_1)a(g_1) \cdots a(g_m)) = \delta_{n,m} \det\{(g_i|Tf_j)\} \quad (57)$$

uniquely extends to a state η_T on $\text{CAR}(\mathfrak{h})$. This state is usually called the quasi-free gauge-invariant state generated by T . The state η_T is completely determined by its two point function

$$\eta_T(a^*(f)a(g)) = (g|Tf).$$

Note that if $A \equiv \sum_j f_j(g_j|\cdot)$ is a finite rank operator on \mathfrak{h} , then

$$d\Gamma(A) = \sum_j a^*(f_j)a(g_j),$$

and

$$\eta_T(d\Gamma(A)) = \text{Tr}(TA) = \sum_j (g_j|Tf_j). \quad (58)$$

Let $(\text{CAR}(\mathfrak{h}), \tau)$ be the fermionic quantization of (\mathfrak{h}, h) . The quasi-free state η_T is τ -invariant iff $e^{ith}T = Te^{ith}$ for all $t \in \mathbb{R}$. In particular, the quasi-free state generated by $T = \varrho(h)$, where ϱ is a positive bounded function on the spectrum of h , is τ -invariant. The function ϱ is the energy density of this quasi-free state. Let $\beta > 0$ and $\mu \in \mathbb{R}$. Of particular importance in quantum statistical mechanics is the quasi-free state associated with $T = \varrho_{\beta\mu}(h)$, where the energy density $\varrho_{\beta\mu}$ is given by the Fermi-Dirac distribution

$$\varrho_{\beta\mu}(\varepsilon) \equiv \frac{1}{e^{\beta(\varepsilon-\mu)} + 1}. \quad (59)$$

We denote this state by $\eta_{\beta\mu}$. The pair $(\text{CAR}(\mathfrak{h}), \tau)$ and the state $\eta_{\beta\mu}$ describe free Fermi gas in thermal equilibrium at inverse temperature β and chemical potential μ .

5.2 Non-equilibrium stationary states

In this and the next subsection we assume that h_λ has a purely absolutely continuous spectrum. We make this assumption in order to ensure that the system will evolve towards a stationary state. This assumption will be partially relaxed in Subsection 5.4, where we discuss the effect of the eigenvalues of h_λ . We do not make any assumptions on the spectrum of $h_{\mathcal{R}}$.

Let η_T be a quasi-free state on $\text{CAR}(\mathbb{C} \oplus \mathfrak{h}_{\mathcal{R}})$ generated by $T = \alpha \oplus T_{\mathcal{R}}$. We denote by $\eta_{T_{\mathcal{R}}}$ the quasi-free state on $\text{CAR}(\mathfrak{h}_{\mathcal{R}})$ generated by $T_{\mathcal{R}}$. We assume that $\eta_{T_{\mathcal{R}}}$ is $\tau_{\mathcal{R}}$ -invariant and denote by $T_{\mathcal{R},ac}$ the restriction of $T_{\mathcal{R}}$ to the subspace $\mathfrak{h}_{ac}(\mathfrak{h}_{\mathcal{R}})$.

Let $\phi_1, \dots, \phi_n \in \mathfrak{h}$ and

$$A = a^\#(\phi_1) \cdots a^\#(\phi_n). \quad (60)$$

Since η_T is τ_0 -invariant,

$$\begin{aligned}\eta_T(\tau_\lambda^t(A)) &= \eta_T(\tau_0^{-t} \circ \tau_\lambda^t(A)) \\ &= \eta_T(a^\#(e^{-it h_0} e^{it h_\lambda} \phi_1) \cdots a^\#(e^{-it h_0} e^{it h_\lambda} \phi_n)).\end{aligned}$$

Hence

$$\lim_{t \rightarrow \infty} \eta_T(\tau_\lambda^t(A)) = \eta_T(a^\#(\Omega_\lambda^- \phi_1) \cdots a^\#(\Omega_\lambda^- \phi_n)).$$

Since the set of observables of the form (60) is dense in \mathfrak{h} , we conclude that for all $A \in \text{CAR}(\mathfrak{h})$ the limit

$$\eta_\lambda^+(A) = \lim_{t \rightarrow \infty} \eta_T(\tau_\lambda^t(A)),$$

exists and defines a state η_λ^+ on $\text{CAR}(\mathfrak{h})$. Note that η_λ^+ is the quasi-free state generated by $T_\lambda^+ \equiv (\Omega_\lambda^-)^* T \Omega_\lambda^-$. Since $\text{Ran } \Omega_\lambda^- = \mathfrak{h}_{\text{ac}}(h_0) = \mathfrak{h}_{\text{ac}}(h_{\mathcal{R}})$, we have

$$T_\lambda^+ = (\Omega_\lambda^-)^* T_{\mathcal{R}, \text{ac}} \Omega_\lambda^-, \quad (61)$$

and so

$$\eta_\lambda^+ = \eta_{T_{\mathcal{R}, \text{ac}}} \circ \sigma_\lambda^+,$$

where σ_λ^+ is the Møller isomorphism introduced in Subsection 4.4. Obviously, η_λ^+ is independent of the choice of α and of the restriction of $T_{\mathcal{R}}$ to $\mathfrak{h}_{\text{sing}}(h_{\mathcal{R}})$. Since

$$e^{it h_\lambda} T_\lambda^+ e^{-it h_\lambda} = (\Omega_\lambda^-)^* e^{it h_{\mathcal{R}}} T_{\mathcal{R}, \text{ac}} e^{-it h_{\mathcal{R}}} \Omega_\lambda^- = T_\lambda^+,$$

η_λ^+ is τ_λ -invariant.

The state η_λ^+ is called the *non-equilibrium stationary state* (NESS) of the CAR dynamical system $(\text{CAR}(\mathfrak{h}), \tau_\lambda)$ associated to the initial state η_T . Note that if $A \equiv \sum_j \phi_j(\psi_j | \cdot)$, then, according to Equ. (58),

$$\eta_\lambda^+(d\Gamma(A)) = \text{Tr}(T \Omega_\lambda^- A \Omega_\lambda^{-*}) = \sum_j (\Omega_\lambda^- \psi_j | T \Omega_\lambda^- \phi_j). \quad (62)$$

By passing to the GNS representation associated to η_T one can prove the following more general result. Let \mathcal{N} be the set of states on $\text{CAR}(\mathfrak{h})$ which are normal with respect to η_T (the set \mathcal{N} does not depend on the choice of α). Then for any $\eta \in \mathcal{N}$ and $A \in \text{CAR}(\mathfrak{h})$,

$$\lim_{t \rightarrow \infty} \eta(\tau_\lambda^t(A)) = \eta_\lambda^+(A).$$

If $T_{\mathcal{R}} = \varrho(h_{\mathcal{R}})$ for some bounded function ϱ on the spectrum of $h_{\mathcal{R}}$, then the intertwining property of the wave operator implies that $T_\lambda^+ = \varrho(h_\lambda)$ and hence $\eta_\lambda^+ = \eta_{\varrho(h_\lambda)}$. In particular, if the reservoir is initially in thermal equilibrium at inverse temperature $\beta > 0$ and chemical potential $\mu \in \mathbb{R}$, then η_λ^+ is the quasi-free state associated to $(e^{\beta(h_\lambda - \mu)} + 1)^{-1}$, which is the thermal equilibrium state of $(\text{CAR}(\mathfrak{h}), \tau_\lambda)$ at the inverse temperature β and chemical potential μ . This type of phenomenon, often called return to equilibrium, is an important part of the zeroth law of thermodynamics and plays a fundamental role in foundations of statistical mechanics.

5.3 Non-equilibrium thermodynamics

In this subsection we again assume that h_λ has purely absolutely continuous spectrum. Concerning the reservoir \mathcal{R} , we assume that $h_{\mathcal{R}}$ is multiplication by x on $\mathfrak{H}_{\mathcal{R}} = L^2(X, d\mu; \mathfrak{K})$, where \mathfrak{K} is a separable Hilbert space. The internal structure of \mathcal{R} is further specified by an orthogonal decomposition $\mathfrak{K} = \bigoplus_{k=1}^M \mathfrak{K}_k$. We set $\mathfrak{H}_{\mathcal{R}_k} = L^2(X, d\mu; \mathfrak{K}_k)$ and denote by $h_{\mathcal{R}_k}$ the operator of multiplication by x on $\mathfrak{H}_{\mathcal{R}_k}$. Thus, we can write

$$\mathfrak{H}_{\mathcal{R}} = \bigoplus_{k=1}^M \mathfrak{H}_{\mathcal{R}_k}, \quad h_{\mathcal{R}} = \bigoplus_{k=1}^M h_{\mathcal{R}_k}. \quad (63)$$

We interpret (63) as a decomposition of the reservoir \mathcal{R} into M independent subreservoirs $\mathcal{R}_1, \dots, \mathcal{R}_M$.

According to (63), we write $f = \bigoplus_{k=1}^M f_k$ and we split the interaction v as $v = \sum_{k=1}^M v_k$, where

$$v_k = (1|\cdot)f_k + (f_k|\cdot)1.$$

In the sequel we assume that $f \in \text{Dom } h_{\mathcal{R}}$. The projection onto the subspace $\mathfrak{H}_{\mathcal{R}_k}$ is denoted by $1_{\mathcal{R}_k}$. Set

$$\begin{aligned} \mathfrak{f}_k &\equiv -\frac{d}{dt} e^{ith_\lambda} h_{\mathcal{R}_k} e^{-ith_\lambda} \Big|_{t=0} \\ &= -i[h_\lambda, h_{\mathcal{R}_k}] = -i[h_S + \sum_j (h_{\mathcal{R}_j} + \lambda v_j), h_{\mathcal{R}_k}] \\ &= \text{li}[h_{\mathcal{R}_k}, v_k] \\ &= \text{li}((1|\cdot)h_{\mathcal{R}_k}f_k - (h_{\mathcal{R}_k}f_k|\cdot)1), \end{aligned} \quad (64)$$

and

$$\begin{aligned} \mathfrak{j}_k &\equiv -\frac{d}{dt} e^{ith_\lambda} 1_{\mathcal{R}_k} e^{-ith_\lambda} \Big|_{t=0} \\ &= -i[h_\lambda, 1_{\mathcal{R}_k}] = -i[h_S + \sum_j (h_{\mathcal{R}_j} + \lambda v_j), 1_{\mathcal{R}_k}] \\ &= \text{li}[1_{\mathcal{R}_k}, v_k] \\ &= \text{li}((1|\cdot)f_k - (f_k|\cdot)1). \end{aligned} \quad (65)$$

The observables describing the heat and particle fluxes out of the k -th subreservoir are

$$\mathfrak{F}_k \equiv d\Gamma(\mathfrak{f}_k) = \text{li}(a^*(h_{\mathcal{R}_k}f_k)a(1) - a^*(1)a(h_{\mathcal{R}_k}f_k)),$$

$$\mathfrak{J}_k \equiv d\Gamma(\mathfrak{j}_k) = \text{li}(a^*(f_k)a(1) - a^*(1)a(f_k)).$$

We assume that the initial state of the coupled system $\mathcal{S} + \mathcal{R}$ is the quasi-free state associated to $T \equiv \alpha \oplus T_{\mathcal{R}}$, where

$$T_{\mathcal{R}} = \bigoplus_{k=1}^M T_{\mathcal{R}_k} = \bigoplus_{k=1}^M \varrho_k(h_{\mathcal{R}_k}),$$

and ϱ_k is a bounded positive measurable function on X .

Let η_{λ}^+ be the NESS of $(\text{CAR}(\mathfrak{h}), \tau_{\lambda})$ associated to the initial state η_T . According to Equ. (61) and (58), the steady state heat current out of the subreservoir \mathcal{R}_k is

$$\begin{aligned} \eta_{\lambda}^+(\mathfrak{F}_k) &= \text{Tr}(T_{\lambda}^+ \mathfrak{f}_k) = \text{Tr}(T_{\mathcal{R}} \Omega_{\lambda}^- \mathfrak{f}_k (\Omega_{\lambda}^-)^*) \\ &= \sum_{j=1}^M \text{Tr}(\varrho_j(h_{\mathcal{R}_j}) 1_{\mathcal{R}_j} \Omega_{\lambda}^- \mathfrak{f}_k (\Omega_{\lambda}^-)^* 1_{\mathcal{R}_j}). \end{aligned}$$

Using Equ. (64) we can rewrite this expression as

$$\eta_{\lambda}^+(\mathfrak{F}_k) = 2\lambda \sum_{j=1}^M \text{Im} (1_{\mathcal{R}_j} \Omega_{\lambda}^- h_{\mathcal{R}_k} f_k | \varrho_j(h_{\mathcal{R}_j}) 1_{\mathcal{R}_j} \Omega_{\lambda}^- 1).$$

Equ. (28) yields the relations

$$\begin{aligned} (\varrho_j(h_{\mathcal{R}_j}) 1_{\mathcal{R}_j} \Omega_{\lambda}^- 1)(x) &= -\lambda \varrho_j(x) F_{\lambda}(x - i0) f_j(x), \\ \overline{(1_{\mathcal{R}_j} \Omega_{\lambda}^- h_{\mathcal{R}_k} f_k)(x)} &= (\delta_{kj} x + \lambda^2 F_{\lambda}(x + i0) H_k(x + i0)) \overline{f_j(x)}, \end{aligned}$$

where we have set

$$H_k(z) \equiv \int_X \frac{x \|f_k(x)\|_{\mathfrak{R}_k}^2}{x - z} d\mu(x).$$

Since $\text{Ran } \Omega_{\lambda}^- = \mathfrak{h}_{\text{ac}}(h_{\mathcal{R}})$, it follows that $(1_{\mathcal{R}_j} \Omega_{\lambda}^- h_{\mathcal{R}_k} f_k | \varrho_j(h_{\mathcal{R}_j}) 1_{\mathcal{R}_j} \Omega_{\lambda}^- 1)$ is equal to

$$\lambda \int_X (\delta_{kj} x F_{\lambda}(x + i0) - \lambda^2 |F_{\lambda}(x + i0)|^2 H_k(x + i0)) \|f_j(x)\|_{\mathfrak{R}_j}^2 \varrho_j(x) d\mu_{\text{ac}}(x).$$

From Equ. (18) we deduce that

$$\text{Im } H_k(x + i0) = \pi x \|f_k(x)\|_{\mathfrak{R}_k}^2 \frac{d\mu_{\text{ac}}}{dx}(x),$$

for Lebesgue a.e. $x \in X$. Equ. (19) yields

$$\text{Im } F_{\lambda}(x + i0) = \pi \lambda^2 |F_{\lambda}(x + i0)|^2 \|f(x)\|_{\mathfrak{R}}^2 \frac{d\mu_{\text{ac}}}{dx}(x).$$

It follows that $\text{Im} (1_{\mathcal{R}_j} \Omega_{\lambda}^- h_{\mathcal{R}_k} f_k | \varrho_j(h_{\mathcal{R}_j}) 1_{\mathcal{R}_j} \Omega_{\lambda}^- 1)$ is equal to

$$\lambda^3 \pi \int_X (\delta_{kj} \|f(x)\|_{\mathfrak{R}}^2 - \|f_k(x)\|_{\mathfrak{R}_k}^2) \|f_j(x)\|_{\mathfrak{R}_j}^2 |F_{\lambda}(x + i0)|^2 x \varrho_j(x) \left(\frac{d\mu_{\text{ac}}}{dx}(x) \right)^2 dx.$$

Finally, using the fact that $\|f(x)\|_{\mathfrak{R}}^2 = \sum_j \|f_j(x)\|_{\mathfrak{R}_j}^2$, we obtain

$$\eta_\lambda^+(\mathfrak{F}_k) = \sum_{j=1}^M \int_X x(\varrho_k(x) - \varrho_j(x)) D_{kj}(x) \frac{dx}{2\pi}, \quad (66)$$

where

$$D_{kj}(x) \equiv 4\pi^2 \lambda^4 \|f_k(x)\|_{\mathfrak{h}_k}^2 \|f_j(x)\|_{\mathfrak{h}_j}^2 |F_\lambda(x + i0)|^2 \left(\frac{d\mu_{ac}}{dx}(x) \right)^2. \quad (67)$$

Proceeding in a completely similar way we obtain the following formula for the steady particle current

$$\eta_\lambda^+(\mathfrak{J}_k) = \sum_{j=1}^M \int_X (\varrho_k(x) - \varrho_j(x)) D_{kj}(x) \frac{dx}{2\pi}. \quad (68)$$

There are several ways to interpret the quantity D_{kj} in Equ. (67). In spectral theoretic terms, we can invoke Equ. (18) and (19) to write

$$D_{kj} = 4\pi^2 \lambda^2 \frac{d\mu_{ac}^\lambda}{d\mu_{\mathcal{R},ac}} \frac{d\mu_{\mathcal{R}_k,ac}}{dx} \frac{d\mu_{\mathcal{R}_j,ac}}{dx},$$

where $d\mu_{\mathcal{R}_k}$ denotes the spectral measure of $h_{\mathcal{R}_k}$ for f_k . It is also possible to relate D_{kj} to the S -matrix associated to Ω_λ^\pm . According to the decomposition (63), this S -matrix can be written as

$$(1_{\mathcal{R}_k} S \psi)(x) = \sum_{j=1}^M S_{kj}(x) (1_{\mathcal{R}_j} \psi)(x) \equiv (1_{\mathcal{R}_k} \psi)(x) + \sum_{j=1}^M t_{kj}(x) (1_{\mathcal{R}_j} \psi)(x).$$

Equ. (29) yields that the t -matrix defined by this relation can be expressed as

$$t_{kj}(x) = 2\pi i \lambda^2 \frac{d\mu_{\mathcal{R},ac}}{dx}(x) F_\lambda(x + i0) f_k(x) (f_j(x) | \cdot)_{\mathfrak{R}_j},$$

and we derive that

$$D_{kj}(x) = \text{Tr}_{\mathfrak{R}_j} \left(t_{kj}(x)^* t_{kj}(x) \right). \quad (69)$$

Equ. (66), (68) together with (69) are the well-known Büttiker-Landauer formulas for the steady currents.

It immediately follows from Equ. (66) that

$$\sum_{k=1}^M \eta_\lambda^+(\mathfrak{F}_k) = 0,$$

which is the first law of thermodynamics (conservation of energy). Similarly, particle number conservation

$$\sum_{k=1}^M \eta_\lambda^+(\mathfrak{J}_k) = 0,$$

follows from Equ. (68).

To describe the entropy production of the system, assume that the k -th subreservoir is initially in thermal equilibrium at inverse temperature $\beta_k > 0$ and chemical potential $\mu_k \in \mathbb{R}$. This means that

$$\varrho_k(x) = F(Z_k(x)),$$

where $F(t) \equiv (e^t + 1)^{-1}$ and $Z_k(x) \equiv \beta_k(x - \mu_k)$. The entropy production observable is then given by

$$\sigma \equiv - \sum_{k=1}^M \beta_k (\mathfrak{F}_k - \mu_k \mathfrak{J}_k).$$

The entropy production rate of the NESS η_λ^+ is

$$\text{Ep}(\eta_\lambda^+) = \eta_\lambda^+(\sigma) = \frac{1}{2} \sum_{k,j=1}^M \int_X (Z_j - Z_k)(F(Z_k) - F(Z_j)) D_{kj} \frac{dx}{2\pi}. \quad (70)$$

Since the function F is monotone decreasing, $\text{Ep}(\eta_\lambda^+)$ is clearly non-negative. This is the second law of thermodynamics (increase of entropy). Note that in the case of two subreservoirs with $\mu_1 = \mu_2$ the positivity of entropy production implies that the heat flows from the hot to the cold reservoir. For $k \neq j$ let

$$F_{kj} \equiv \{x \in X \mid \|f_k(x)\|_{\mathfrak{h}_k} \|f_j(x)\|_{\mathfrak{h}_j} > 0\}.$$

The subreservoirs \mathcal{R}_k and \mathcal{R}_j are *effectively coupled* if $\mu_{ac}(F_{kj}) > 0$. The SEBB model is thermodynamically trivial unless some of the subreservoirs are effectively coupled. If \mathcal{R}_k and \mathcal{R}_j are effectively coupled, then $\text{Ep}(\eta_\lambda^+) > 0$ unless $\beta_k = \beta_j$ and $\mu_k = \mu_j$, that is, unless the reservoirs \mathcal{R}_k and \mathcal{R}_j are in the same thermodynamical state.

5.4 The effect of eigenvalues

In our study of NESS and thermodynamics in Subsections 5.2 and 5.3 we have made the assumption that h_λ has purely absolutely continuous spectrum. If $X \neq \mathbb{R}$, then this assumption does not hold for λ large. For example, if $X =]0, \infty[$, $\omega > 0$, and

$$\lambda^2 > \omega \left(\int_0^\infty \|f(x)\|_{\mathfrak{h}}^2 x^{-1} d\mu(x) \right)^{-1},$$

then h_λ will have an eigenvalue in $] -\infty, 0[$. In particular, if

$$\int_0^\infty \|f(x)\|_{\mathfrak{h}}^2 x^{-1} d\mu(x) = \infty,$$

then h_λ will have a negative eigenvalue for all $\lambda \neq 0$. Hence, the assumption that h_λ has empty point spectrum is very restrictive, and it is important to understand

the NESS and thermodynamics of the SEBB model in the case where h_λ has some eigenvalues. Of course, we are concerned only with point spectrum of h_λ restricted to the cyclic subspace generated by the vector $\mathbf{1}$.

Assume that λ is such that $\text{sp}_{\text{pp}}(h_\lambda) \neq \emptyset$ and $\text{sp}_{\text{sc}}(h_\lambda) = \emptyset$. We make no assumption on the structure of $\text{sp}_{\text{pp}}(h_\lambda)$; in particular this point spectrum may be dense in some interval. We also make no assumptions on the spectrum of $h_{\mathcal{R}}$.

For notational simplicity, in this subsection we write \mathfrak{h}_{ac} for $\mathfrak{h}_{\text{ac}}(h_\lambda)$, $\mathbf{1}_{\text{ac}}$ for $\mathbf{1}_{\text{ac}}(h_\lambda)$, etc.

Let T and η_T be as in Subsection 5.2 and let $\phi, \psi \in \mathfrak{h} = \mathbb{C} \oplus \mathfrak{h}_{\mathcal{R}}$. Then,

$$\eta_T(\tau_\lambda^t(a^*(\phi)a(\psi))) = (e^{ith_\lambda}\psi|Te^{ith_\lambda}\phi) = \sum_{j=1}^3 N_j(e^{ith_\lambda}\psi, e^{ith_\lambda}\phi),$$

where we have set

$$N_1(\psi, \phi) \equiv (\mathbf{1}_{\text{ac}}\psi|T\mathbf{1}_{\text{ac}}\phi),$$

$$N_2(\psi, \phi) \equiv 2\text{Re}(\mathbf{1}_{\text{pp}}\psi|T\mathbf{1}_{\text{ac}}\phi),$$

$$N_3(\psi, \phi) \equiv (\mathbf{1}_{\text{pp}}\psi|T\mathbf{1}_{\text{pp}}\phi).$$

Since $e^{-ith_0}T = Te^{-ith_0}$, we have

$$N_1(e^{ith_\lambda}\psi, e^{ith_\lambda}\phi) = (e^{-ith_0}e^{ith_\lambda}\mathbf{1}_{\text{ac}}\psi|Te^{-ith_0}e^{ith_\lambda}\mathbf{1}_{\text{ac}}\phi),$$

and so

$$\lim_{t \rightarrow \infty} N_1(e^{ith_\lambda}\psi, e^{ith_\lambda}\phi) = (\Omega_\lambda^- \psi | T \Omega_\lambda^- \phi).$$

Since \mathfrak{h} is separable, there exists a sequence P_n of finite rank projections commuting with h_λ such that $s\text{-}\lim P_n = \mathbf{1}_{\text{pp}}$. The Riemann-Lebesgue lemma yields that for all n

$$\lim_{t \rightarrow \infty} \|P_n T e^{ith_\lambda} \mathbf{1}_{\text{ac}} \phi\| = 0.$$

The relation

$$\begin{aligned} N_2(e^{ith_\lambda}\psi|e^{ith_\lambda}\phi) &= (e^{ith_\lambda}\mathbf{1}_{\text{pp}}\psi|P_n T e^{ith_\lambda}\mathbf{1}_{\text{ac}}\phi) \\ &\quad + (e^{ith_\lambda}(I - P_n)\mathbf{1}_{\text{pp}}\psi|T e^{ith_\lambda}\mathbf{1}_{\text{ac}}\phi), \end{aligned}$$

yields that

$$\lim_{t \rightarrow \infty} N_2(e^{ith_\lambda}\psi, e^{ith_\lambda}\phi) = 0.$$

Since $N_3(e^{ith_\lambda}\psi, e^{ith_\lambda}\phi)$ is either a periodic or a quasi-periodic function of t , the limit

$$\lim_{t \rightarrow \infty} \eta_T(\tau_\lambda^t(a^*(\phi)a(\psi))),$$

does not exist in general. The resolution of this difficulty is well known—to extract the steady part of a time evolution in the presence of a (quasi-)periodic component one needs to average over time. Indeed, one easily shows that

$$\lim_{t \rightarrow \infty} \frac{1}{t} \int_0^t N_3(e^{ish_\lambda} \psi, e^{ish_\lambda} \phi) ds = \sum_{e \in \text{sp}_p(h_\lambda)} (P_e \psi | T P_e \phi),$$

where P_e denotes the spectral projection of h_λ associated with the eigenvalue e . Hence,

$$\lim_{t \rightarrow \infty} \frac{1}{t} \int_0^t \eta_T(\tau_\lambda^s(a^*(\phi)a(\psi))) ds = \sum_{e \in \text{sp}_p(h_\lambda)} (P_e \psi | T P_e \phi) + (\Omega_\lambda^- \psi | T \Omega_\lambda^- \phi).$$

In a similar way one concludes that for any observable of the form

$$A = a^*(\phi_n) \cdots a^*(\phi_1) a(\psi_1) \cdots a(\psi_m), \quad (71)$$

the limit

$$\lim_{t \rightarrow \infty} \frac{1}{t} \int_0^t \eta_T(\tau_\lambda^s(A)) ds = \delta_{n,m} \lim_{t \rightarrow \infty} \frac{1}{t} \int_0^t \det\{(e^{ish_\lambda} \psi_i | T e^{ish_\lambda} \phi_j)\} ds,$$

exists and is equal to the limit

$$\lim_{t \rightarrow \infty} \frac{1}{t} \int_0^t \det\{(e^{ish_\lambda} \mathbf{1}_{pp} \psi_i | T e^{ish_\lambda} \mathbf{1}_{pp} \phi_j) + (\Omega_\lambda^- \mathbf{1}_{ac} \psi_i | T \Omega_\lambda^- \mathbf{1}_{ac} \phi_j)\} ds, \quad (72)$$

see [Kat] Section VI.5 for basic results about quasi-periodic function on \mathbb{R} . Since the linear span of the set of observables of the form (71) is dense in \mathfrak{h} , we conclude that for all $A \in \text{CAR}(\mathfrak{h})$ the limit

$$\eta_\lambda^+(A) = \lim_{t \rightarrow \infty} \frac{1}{t} \int_0^t \eta_T(\tau_\lambda^s(A)) ds,$$

exists and defines a state η_λ^+ on $\text{CAR}(\mathfrak{h})$. By the construction, this state is τ_λ -invariant. η_λ^+ is the NESS of $(\text{CAR}(\mathfrak{h}), \tau_\lambda)$ associated to the initial state η_T . Note that this definition reduces to the previous if the point spectrum of h_λ is empty.

To further elucidate the structure of η_λ^+ we will make use of the decomposition

$$\mathfrak{h} = \mathfrak{h}_{ac} \oplus \mathfrak{h}_{pp}. \quad (73)$$

The subspaces \mathfrak{h}_{ac} and \mathfrak{h}_{pp} are invariant under h_λ and we denote the restrictions of τ_λ to $\text{CAR}(\mathfrak{h}_{ac})$ and $\text{CAR}(\mathfrak{h}_{pp})$ by $\tau_{\lambda,ac}$ and $\tau_{\lambda,pp}$. We also denote by $\eta_{\lambda,ac}^+$ and $\eta_{\lambda,pp}^+$ the restrictions of η_λ^+ to $\text{CAR}(\mathfrak{h}_{ac})$ and $\text{CAR}(\mathfrak{h}_{pp})$. $\eta_{\lambda,ac}^+$ is the quasi-free state generated by $T_\lambda^+ \equiv (\Omega_\lambda^-)^* T \Omega_\lambda^-$. If A is of the form (71) and $\phi_j, \psi_i \in \mathfrak{h}_{pp}$, then

$$\eta_{\lambda,pp}^+(A) = \delta_{n,m} \lim_{t \rightarrow \infty} \frac{1}{t} \int_0^t \det\{(e^{ish_\lambda} \psi_i | T e^{ish_\lambda} \phi_j)\} ds.$$

Clearly, $\eta_{\lambda,ac}^+$ is $\tau_{\lambda,ac}$ invariant and $\eta_{\lambda,pp}^+$ is $\tau_{\lambda,pp}$ invariant. Expanding the determinant in (72) one can easily see that $\eta_{\lambda,ac}^+$ and $\eta_{\lambda,pp}^+$ uniquely determine η_λ^+ .

While the state $\eta_{\lambda, \text{pp}}^+$ obviously depends on the choice of α and on $T_{\mathcal{R}}|_{\mathfrak{h}_{\text{sing}}(h_{\mathcal{R}})}$ in $T = \alpha \oplus T_{\mathcal{R}}$, the state $\eta_{\lambda, \text{ac}}^+$ does not. In fact, if η is any initial state normal w.r.t. η_T , then for $A \in \text{CAR}(\mathfrak{h}_{\text{ac}})$,

$$\lim_{t \rightarrow \infty} \eta(\tau_{\lambda}^t(A)) = \eta_{\lambda, \text{ac}}^+(A).$$

For a finite rank operator $A \equiv \sum_j \phi_j(\psi_j | \cdot)$ one has

$$\eta_{\lambda}^+(\text{d}\Gamma(A)) = \sum_j \eta_{\lambda}^+(a^*(\phi_j)a(\psi_j)),$$

and so

$$\eta_{\lambda}^+(\text{d}\Gamma(A)) = \sum_j \left(\sum_{e \in \text{sp}_{\text{p}}(h_{\lambda})} (P_e \psi_j | T P_e \phi_j) + (\Omega_{\lambda}^- \psi_j | T \Omega_{\lambda}^- \phi_j) \right).$$

The conclusion is that in the presence of eigenvalues one needs to add the term

$$\sum_j \sum_{e \in \text{sp}_{\text{p}}(h_{\lambda})} (P_e \psi_j | T P_e \phi_j),$$

to Equ. (62), *i.e.*, we obtain the following formula generalizing Equ. (62),

$$\eta_{\lambda}^+(\text{d}\Gamma(A)) = \text{Tr} \left\{ T \left(\sum_{e \in \text{sp}_{\text{p}}(h_{\lambda})} P_e A P_e + \Omega_{\lambda}^- A \Omega_{\lambda}^{-*} \right) \right\}. \quad (74)$$

Note that if for some operator q , $A = \text{i}[h_{\lambda}, q]$ in the sense of quadratic forms on $\text{Dom } h_{\lambda}$, then $P_e A P_e = 0$ and eigenvalues do not contribute to $\eta_{\lambda}^+(\text{d}\Gamma(A))$. This is the case of the current observables $\text{d}\Gamma(\mathfrak{f}_k)$ and $\text{d}\Gamma(\mathfrak{j}_k)$ of Subsection 5.3. We conclude that the formulas (66) and (68), which we have previously derived under the assumption $\text{sp}_{\text{sing}}(h_{\lambda}) = \emptyset$, remain valid as long as $\text{sp}_{\text{sc}}(h_{\lambda}) = \emptyset$, *i.e.*, they are not affected by the presence of eigenvalues.

5.5 Thermodynamics in the non-perturbative regime

The results of the previous subsection can be summarized as follows.

If $\text{sp}_{\text{sc}}(h_{\lambda}) = \emptyset$ and $\text{sp}_{\text{pp}}(h_{\lambda}) \neq \emptyset$ then, on the qualitative level, the thermodynamics of the SEBB model is similar to the case $\text{sp}_{\text{sing}}(h_{\lambda}) = 0$. To construct NESS one takes the ergodic averages of the states $\eta_T \circ \tau_{\lambda}^t$. The NESS is unique. The formulas for steady currents and entropy production are not affected by the point spectra and are given by (66), (68), (70) and (67) or (69) for all $\lambda \neq 0$. In particular, *the NESS and thermodynamics are well defined for all $\lambda \neq 0$ and all ω* . One can proceed further along the lines of [AJPP1] and study the linear response theory of the SEBB model (Onsager relations, Kubo formulas, etc) in the non-perturbative

regime. Given the results of the previous subsection, the arguments and the formulas are exactly the same as in [AJPP1] and we will not reproduce them here.

The study of NESS and thermodynamics is more delicate in the presence of singular continuous spectrum and we will not pursue it here. We wish to point, however, that unlike the point spectrum, the singular continuous spectrum can be excluded in "generic" physical situations. Assume that X is an open set and that the absolutely continuous spectrum of $h_{\mathcal{R}}$ is "well-behaved" in the sense that $\text{Im } F_{\mathcal{R}}(x + i0) > 0$ for Lebesgue a.e. $x \in X$. Then, by the Simon-Wolff theorem 5, h_{λ} has no singular continuous spectrum for Lebesgue a.e. $\lambda \in \mathbb{R}$. If f is a continuous function and $d\mu_{\mathcal{R}} = dx$, then h_{λ} has no singular continuous spectrum for all λ .

5.6 Properties of the fluxes

In this subsection we consider an SEBB model without singular continuous spectrum, *i.e.*, we assume that $\text{sp}_{\text{sc}}(h_{\lambda}) = \emptyset$ for all λ and ω . We will study the properties of the steady currents as functions of (λ, ω) . For this reason, we will again indicate explicitly the dependence on ω .

More precisely, in this subsection we will study the properties of the function

$$(\lambda, \omega) \mapsto \eta_{\lambda, \omega}^+(\mathfrak{F}), \quad (75)$$

where \mathfrak{F} is one of the observables \mathfrak{F}_k or \mathfrak{J}_k for a given k . For simplicity of exposition, besides Assumption (A1) we assume that the functions

$$g_j(t) \equiv \int_X e^{-itx} \|f_j(x)\|_{\mathfrak{R}_j}^2 dx,$$

are in $L^1(\mathbb{R}, dt)$ and that $\|f(x)\|_{\mathfrak{R}}$ is non-vanishing on X . We also assume that the energy densities $\varrho_j(x)$ of the subreservoirs are bounded continuous functions on X and that the functions $(1 + |x|)\varrho_j(x)$ are integrable on X . According to Equ. (66), (68) and (67), one has

$$\eta_{\lambda, \omega}^+(\mathfrak{F}) = 2\pi\lambda^4 \sum_{j=1}^M \int_X \|f_k(x)\|_{\mathfrak{R}_k}^2 \|f_j(x)\|_{\mathfrak{R}_j}^2 |F_{\lambda}(x + i0)|^2 x^n (\varrho_k(x) - \varrho_j(x)) dx,$$

where $n = 0$ if $\mathfrak{F} = \mathfrak{J}_k$ and $n = 1$ if $\mathfrak{F} = \mathfrak{F}_k$.

Obviously, the function (75) is real-analytic on $\mathbb{R} \times \mathbb{R} \setminus \overline{X}$ and for a given $\omega \notin \overline{X}$,

$$\eta_{\lambda, \omega}^+(\mathfrak{F}) = O(\lambda^4), \quad (76)$$

as $\lambda \rightarrow 0$. The function (75) is also real-analytic on $\mathbb{R} \setminus \{0\} \times \mathbb{R}$. For $\omega \in X$, Lemma 3 shows that

$$\lim_{\lambda \downarrow 0} \lambda^{-2} \eta_{\omega, \lambda}^+(\mathfrak{F}) = 2\pi \sum_{j=1}^M \frac{\|f_k(\omega)\|_{\mathfrak{R}_k}^2 \|f_j(\omega)\|_{\mathfrak{R}_j}^2}{\|f(\omega)\|_{\mathfrak{R}}^2} \omega^n (\varrho_k(\omega) - \varrho_j(\omega)). \quad (77)$$

Comparing (76) and (77) we see that in the weak coupling limit we can distinguish two regimes: the "conducting" regime $\omega \in X$ and the "insulating" regime $\omega \notin \bar{X}$. Clearly, the conducting regime coincides with the "resonance" regime for $h_{\lambda,\omega}$ and, colloquially speaking, the currents are carried by the resonance pole. In the insulating regime there is no resonance for small λ and the corresponding heat flux is infinitesimal compared to the heat flux in the "conducting" regime.

For $x \in X$ one has

$$\lambda^4 |F_\lambda(x + i0)|^2 = \frac{\lambda^4}{(\omega - x - \lambda^2 \operatorname{Re} F_{\mathcal{R}}(x + i0))^2 + \lambda^4 \pi^2 \|f(x)\|_{\mathfrak{R}}^4}.$$

Hence,

$$\sup_{\lambda \in \mathbb{R}} \lambda^4 |F_\lambda(x + i0)|^2 = \left(\pi \sum_{j=1}^M \|f_j(x)\|_{\mathfrak{R}_j}^2 \right)^{-2}, \quad (78)$$

and so

$$\lambda^4 \|f_k(x)\|_{\mathfrak{R}_k}^2 \|f_j(x)\|_{\mathfrak{R}_j}^2 |F_\lambda(x + i0)|^2 \leq \frac{1}{\pi^2}.$$

This estimate and the dominated convergence theorem yield that for all $\omega \in \mathbb{R}$,

$$\lim_{|\lambda| \rightarrow \infty} \eta_{\lambda,\omega}^+(\mathfrak{F}) = 2\pi \sum_{j=1}^M \int_X \frac{\|f_k(x)\|_{\mathfrak{R}_k}^2 \|f_j(x)\|_{\mathfrak{R}_j}^2}{|F_{\mathcal{R}}(x + i0)|^2} x^n (\varrho_k(x) - \varrho_j(x)) dx. \quad (79)$$

Thus, the steady currents are independent of ω in the strong coupling limit. In the same way one shows that

$$\lim_{|\omega| \rightarrow \infty} \eta_{\lambda,\omega}^+(\mathfrak{F}) = 0, \quad (80)$$

for all λ .

The cross-over between the weak coupling regime (77) and the large coupling regime (79) is delicate and its study requires detailed information about the model. We will discuss this topic further in the next subsection.

We finish this subsection with one simple but physically important remark. Assume that the functions

$$C_j(x) \equiv 2\pi \|f_k(x)\|_{\mathfrak{R}_k}^2 \|f_j(x)\|_{\mathfrak{R}_j}^2 x^n (\varrho_k(x) - \varrho_j(x)),$$

are sharply peaked around the points \bar{x}_j . This happens, for example, if all the reservoirs are at thermal equilibrium at low temperatures. Then, the flux (75) is well approximated by the formula

$$\eta_{\lambda,\omega}^+(\mathfrak{F}) \simeq \sum_{j=1}^M \lambda^4 |F_\lambda(\bar{x}_j)|^2 \int_X C_j(x) dx,$$

and since the supremum in (78) is achieved at $\omega = x + \lambda^2 \operatorname{Re} F_\lambda(x + i0)$, the flux (75) will be peaked along the parabolic resonance curves

$$\omega = \bar{x}_j + \lambda^2 \operatorname{Re} F_\lambda(\bar{x}_j + i0).$$

5.7 Examples

We finish these lecture notes with several examples of the SEBB model which we will study using numerical calculations. For simplicity, we will only consider the case of two subreservoirs, *i.e.*, in this subsection $\mathfrak{K} = \mathbb{C}^2 = \mathbb{C} \oplus \mathbb{C}$. We also take

$$f(x) = f_1(x) \oplus f_2(x) \equiv \frac{1}{\sqrt{2}} \begin{pmatrix} f_0(x) \\ 0 \end{pmatrix} \oplus \frac{1}{\sqrt{2}} \begin{pmatrix} 0 \\ f_0(x) \end{pmatrix},$$

so that

$$\|f_1(x)\|_{\mathfrak{K}_1}^2 = \|f_2(x)\|_{\mathfrak{K}_2}^2 = \frac{1}{2} \|f(x)\|_{\mathfrak{K}}^2 = \frac{1}{2} |f_0(x)|^2.$$

Example 1. We consider the fermionic quantization of Example 1 in Subsection 3.5, *i.e.*, $\mathfrak{h}_{\mathcal{R}} = L^2(]0, \infty[, dx; \mathbb{C}^2)$ and

$$f_0(x) = \pi^{-1/2} (2x)^{1/4} (1+x^2)^{-1/2}.$$

We put the two subreservoirs at thermal equilibrium

$$\varrho_j(x) = \frac{1}{1 + e^{\beta_j(x - \mu_j)}},$$

where we set the inverse temperatures to $\beta_1 = \beta_2 = 50$ (low temperature) and the chemical potentials to $\mu_1 = 0.3$, $\mu_2 = 0.2$. We shall only consider the particle flux ($n = 0$) in this example. The behavior of the heat flux is similar. The function

$$C_2(x) = 2\pi \|f_1(x)\|_{\mathfrak{K}_1}^2 \|f_2(x)\|_{\mathfrak{K}_2}^2 (\varrho_1(x) - \varrho_2(x)) = \frac{x(\varrho_1(x) - \varrho_2(x))}{\pi(1+x^2)^2},$$

plotted in Figure 11, is peaked at $\bar{x} \simeq 0.25$. In accordance with our discussion in the previous subsection, the particle current, represented in Figure 12, is sharply peaked around the parabola $\omega = \bar{x} + 2\lambda^2(1 - \bar{x})/(1 + \bar{x}^2)$ (dark line). The convergence to an ω -independent limit as $\lambda \rightarrow \infty$ and convergence to 0 as $\omega \rightarrow \infty$ are also clearly illustrated.

Example 2. We consider now the heat flux in the SEBB model corresponding to Example 2 of Subsection 3.5. Here $\mathfrak{h}_{\mathcal{R}} = L^2(]-1, 1[, dx; \mathbb{C}^2)$,

$$f_0(x) = \sqrt{\frac{2}{\pi}} (1-x^2)^{1/4},$$

and we choose the high temperature regime by setting $\beta_1 = \beta_2 = 0.1$, $\mu_1 = 0.3$ and $\mu_2 = 0.2$. Convergence of the rescaled heat flux to the weak coupling limit (77) is illustrated in Figure 13. In this case the function C_2 is given by

$$C_2(x) = \frac{2}{\pi} x(1-x^2)(\varrho_1(x) - \varrho_2(x)),$$

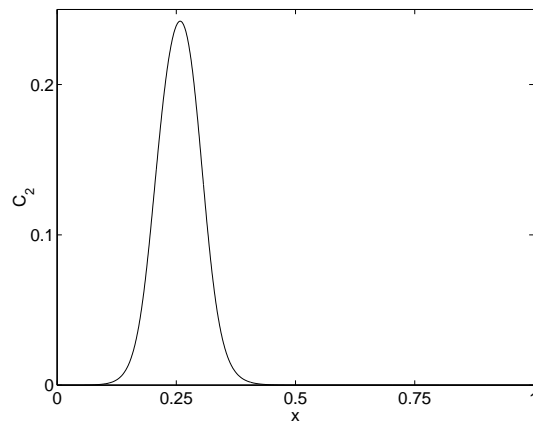

Fig. 11. The function $C_2(x)$ in Example 1.

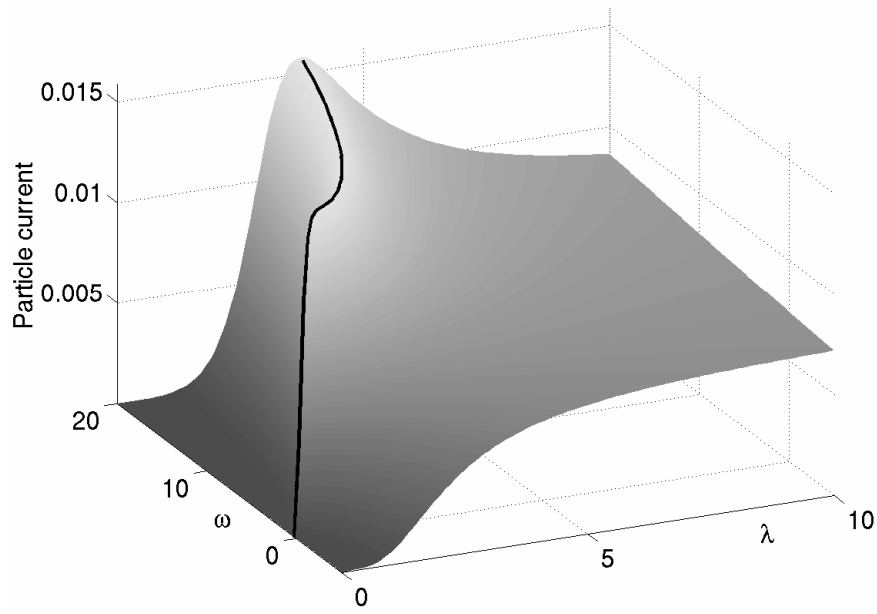

Fig. 12. The particle flux in Example 1.

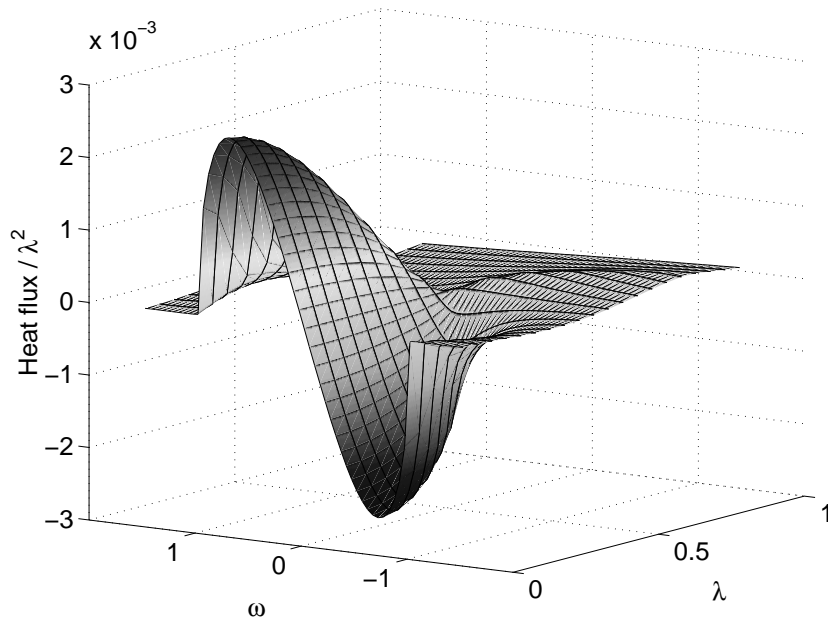

Fig. 13. The rescaled heat flux (weak coupling regime) in Example 2.

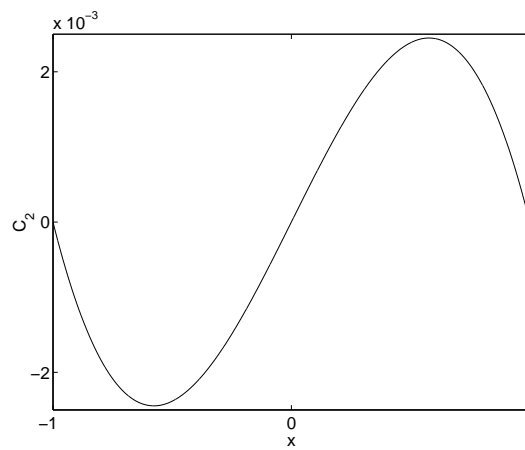

Fig. 14. The function $C_2(x)$ in Example 2.

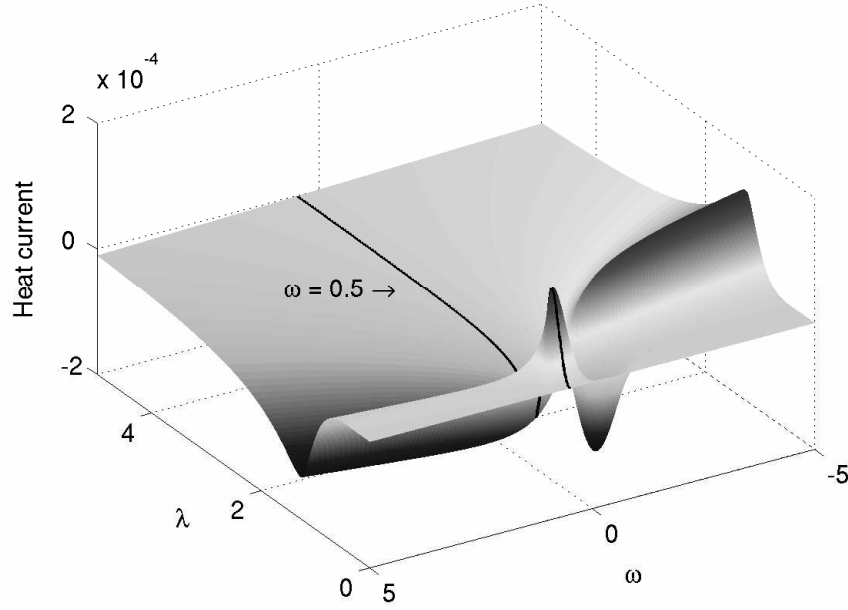

Fig. 15. The heat flux in Example 2.

and is completely delocalized as shown in Figure 14.

Even in this simple example the cross-over between the weak and the strong coupling regime is difficult to analyze. This cross-over is non trivial, as can be seen in Figure 15. Note in particular that the function $\lambda \mapsto \eta_{\lambda,\omega}^+(\mathfrak{F})$ is not necessarily monotone and may have several local minima/maxima before reaching its limiting value (79) as shown by the section $\omega = 0.5$ in Figure 15.

Example 3. In this example we will discuss the large coupling limit. Note that in the case of two subreservoirs Equ. (79) can be written as

$$\lim_{|\lambda| \rightarrow \infty} \eta_{\lambda,\omega}^+(\mathfrak{F}) = \frac{1}{2\pi} \int_X \sin^2 \theta(x) x^n (\varrho_1(x) - \varrho_2(x)) dx, \quad (81)$$

where $\theta(x) \equiv \text{Arg}(F_{\mathcal{R}}(x + i0))$. Therefore, large currents can be obtained if one of the reservoir, say \mathcal{R}_1 , has an energy distribution concentrated in a region where $\text{Im } F_{\mathcal{R}}(x + i0) \gg \text{Re } F_{\mathcal{R}}(x + i0)$ while the energy distribution of \mathcal{R}_2 is concentrated in a region where $\text{Im } F_{\mathcal{R}}(x + i0) \ll \text{Re } F_{\mathcal{R}}(x + i0)$.

As an illustration, we consider the SEBB model corresponding to Example 3 of Subsection 3.5, *i.e.*, $\mathfrak{h}_{\mathcal{R}} = L^2([-1, 1], dx; \mathbb{C}^2)$ and

$$f_0(x) = \sqrt{\frac{1}{\pi}} x(1-x^2)^{1/4}.$$

From Equ. (54) we obtain that

$$F_{\mathcal{R}}(x + i0) = -x \left(x^2 - \frac{1}{2} \right) + ix^2 \sqrt{1 - x^2}.$$

Hence,

$$\sin^2 \theta(x) = 4x^2(1 - x^2),$$

reaches its maximal value 1 at energy $x = \pm 1/\sqrt{2}$.

We use the following initial states: the first subreservoir has a quasi-monochromatic energy distribution

$$\varrho_1(x) \equiv 3 e^{-1000(x-\Omega)^2},$$

at energy $\Omega \in [-1, 1]$. The second subreservoir is at thermal equilibrium at low temperature $\beta = 10$ and chemical potential $\mu_2 = -0.9$. Thus, ϱ_2 is well localized near the lower band edge $x = -1$ where $\sin \theta$ vanishes. Figure 16 shows the limiting

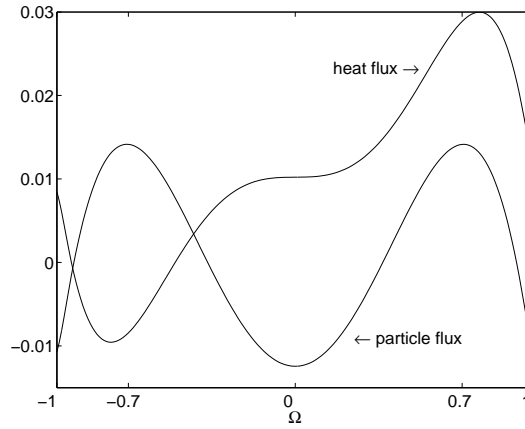

Fig. 16. The limiting particle and heat fluxes in Example 3.

currents (81) as functions of Ω , with extrema near $\pm 1/\sqrt{2} \simeq \pm 0.7$ as expected.

Another feature of Figure 16 is worth a comment. As discussed in Example 3 of Subsection 3.5, this model has a resonance approaching 0 as $\lambda \rightarrow \infty$ and $\lambda^4 |F_\lambda(0 + i0)|^2 \rightarrow |F_{\mathcal{R}}(0 + i0)|^2 = \infty$. However, since

$$\|f_j(0)\|_{\mathfrak{R}_j}^2 = \text{Im } F_{\mathcal{R}}(0 + i0)/2\pi = 0,$$

we have

$$\sin \theta(0) = \lim_{x \rightarrow 0} \frac{\text{Im } F_{\mathcal{R}}(x + i0)}{|F_{\mathcal{R}}(x + i0)|} = 0, \quad (82)$$

and the large coupling resonance near zero does not lead to a noticeable flux enhancement. This can be seen in Figure 16 by noticing that the fluxes at the resonant energy $\Omega = 0$ are the same as at the band edges $\Omega = \pm 1$. It is a simple exercise to show that (82) is related to the fact that the resonance pole of F_λ approaches 0 tangentially to the real axis (see Figure 10).

In fact, the following argument shows that this behavior is typical. Assume that $F_{\mathcal{R}}(z)$ has a meromorphic continuation from the upper half-plane across X with a zero at $\bar{\omega} \in X$ (we argued in our discussion of Example 3 in Subsection 3.5 that this is a necessary condition for $\bar{\omega}$ to be a large coupling resonance). Since $\text{Im } F_{\mathcal{R}}(x + iy) \geq 0$ for $y \geq 0$, it is easy to show, using the power series expansion of $F_{\mathcal{R}}$ around $\bar{\omega}$, that $(\partial_z F_{\mathcal{R}})(\bar{\omega}) > 0$. Combining this fact with the Cauchy-Riemann equations we derive

$$\partial_x \text{Re } F_{\mathcal{R}}(x + i0)|_{x=\bar{\omega}} > 0, \quad \partial_x \text{Im } F_{\mathcal{R}}(x + i0)|_{x=\bar{\omega}} = 0,$$

and so

$$\sin \theta(\bar{\omega}) = 0.$$

Thus, in contrast with the weak coupling resonances, the strong coupling resonances do not induce large currents.

References

- [AC] Aguilar, J., Combes, J.M.: A class of analytic perturbations for one-body Schrödinger Hamiltonians. *Commun. Math. Phys.* **22**, 269 (1971).
- [AJPP1] Aschbacher, W., Jakšić, V., Pautrat, Y., Pillet, C.-A.: Topics in quantum statistical mechanics. In *Open Quantum Systems III*. Lecture Notes of the Summer School on Open Quantum Systems held in Grenoble, June 16–July 4, 2003. To be published in *Lecture Notes in Mathematics*, Springer, New York.
- [AJPP2] Aschbacher, W., Jakšić, V., Pautrat, Y., Pillet, C.-A.: Transport properties of ideal Fermi gases. In preparation.
- [AM] Aizenstadt, V.V., Malyshev, V.A.: Spin interaction with an ideal Fermi gas. *J. Stat. Phys.* **48**, 51 (1987).
- [Ar] Arai, A.: On a model of a harmonic oscillator coupled to a quantized, massless, scalar field. *J. Math. Phys.* **21**, 2539 (1981).
- [BC] Balslev, E., Combes, J.M.: Spectral properties of many-body Schrödinger operators with dilation analytic interactions. *Commun. Math. Phys.* **22**, 280 (1971).
- [Br] Braun, E.: Irreversible behavior of a quantum harmonic oscillator coupled to a heat bath. *Physica A* **129**, 262 (1985).
- [BR1] Bratteli, O., Robinson, D.W.: *Operator Algebras and Quantum Statistical Mechanics I*. Springer, Berlin (1987).
- [BR2] Bratteli, O., Robinson, D. W.: *Operator Algebras and Quantum Statistical Mechanics 2*. Springer, Berlin (1996).
- [BSZ] Baez, J.C., Segal, I.E., Zhou, Z.: *Introduction to algebraic and constructive quantum field theory*. Princeton University Press, Princeton NJ (1991).
- [CFKS] Cycon, H., Froese, R., Kirsch, W., Simon, B.: *Schrödinger Operators*. Springer, Berlin (1987).
- [CL] Carmona, R., Lacroix, J.: *Spectral Theory of Random Schrödinger Operators*. Birkhauser, Boston (1990).
- [CDG] Cohen-Tannoudji, C., Dupont-Roc, J., Grynberg, G.: *Atom-Photon Interactions*. John Wiley, New York (1992).
- [Da1] Davies, E.B.: The harmonic oscillator in a heat bath. *Commun. Math. Phys.* **33**, 171 (1973).

- [Da2] Davies, E.B.: Markovian master equations. *Commun. Math. Phys.* **39**, 91 (1974).
- [Da3] Davies, E.B.: Markovian master equations II. *Math. Ann.* **219**, 147 (1976).
- [Da4] Davies, E.B.: Dynamics of a multilevel Wigner-Weisskopf atom. *J. Math. Phys.* **15**, 2036 (1974).
- [DeB] De Bievre, S.: Local states of free Bose fields. Lecture notes in this volume.
- [Der1] Dereziński, J.: Introduction to representations of canonical commutation and anti-commutation relation. Lecture notes in this volume.
- [Der2] Dereziński, J.: Fermi golden rule, Feshbach method and embedded point spectrum. *Séminaire Equations aux Dérivées Partielles*, 1998–1999, Exp. No. XXIII, 13 pp., Sémin. Equ. Dériv. Partielles, Ecole Polytech., Palaiseau, (1999).
- [Der3] Dereziński, J.: Fermi golden rule and open quantum systems. In *Open Quantum Systems III*. Lecture Notes of the Summer School on Open Quantum Systems held in Grenoble, June 16–July 4, 2003. To be published in *Lecture Notes in Mathematics*, Springer, New York.
- [DFP] del Rio, R., Fuentes S., Poltoratskii, A.G.: Coexistence of spectra in rank-one perturbation problems. *Bol. Soc. Mat. Mexicana* **8**, 49 (2002).
- [Di] Dirac, P.A.M.: The quantum theory of the emission and absorption of radiation. *Proc. Roy. Soc. London, Ser. A* **114**, 243 (1927).
- [DK] Davidson, R., Kozak, J.J.: On the relaxation to quantum-statistical equilibrium of the Wigner-Weisskopf Atom in a one-dimensional radiation field: a study of spontaneous emission. *J. Math. Phys.* **11**, 189 (1970).
- [DMS] del Rio, R., Makarov, N., Simon, B.: Operators with singular continuous spectrum: II. Rank one operators. *Commun. Math. Phys.* **165**, 59 (1994).
- [DS] del Rio, R., Simon, B.: Point spectrum and mixed spectral types for rank one perturbations. *Proc. Amer. Math. Soc.* **125**, 3593 (1997).
- [Fer] Fermi, E.: *Nuclear Physics*. Notes compiled by Orear J., Rosenfeld A.H. and Schluter R.A. The University of Chicago Press, Chicago, (1950).
- [Fr] Friedrichs, K.O.: *Perturbation of Spectra in Hilbert Space*. AMS, Providence (1965).
- [FGP] Frigerio, A., Gorini, V., Pulé, J.V.: Open quasi free systems. *J. Stat. Phys.* **22**, 409 (1980).
- [FKM] Ford, G.W., Kac, M., Mazur, P.: Statistical mechanics of assemblies of coupled oscillators. *J. Math. Phys.* **6**, 504 (1965).
- [Gor] Gordon, A.: Pure point spectrum under 1-parameter perturbations and instability of Anderson localization. *Commun. Math. Phys.* **164**, 489 (1994).
- [Ha] Haag, R.: *Local Quantum Physics*. Springer-Verlag, New York (1993).
- [Haa] Haake, F.: *Statistical treatment of open systems by generalized master equation*. Springer Tracts in Modern Physics **66**, Springer, Berlin (1973).
- [He] Heitler, W.: *The Quantum Theory of Radiation*. Oxford, Oxford University Press (1954).
- [Her] Herbst, I.: Exponential decay in the Stark effect. *Commun. Math. Phys.* **75**, 197 (1980).
- [How] Howland, J.S.: Perturbation theory of dense point spectra. *J. Func. Anal.* **74**, 52 (1987).
- [Ja] Jakšić, V.: Topics in spectral theory. In *Open Quantum Systems I*. Lecture Notes of the Summer School on Open Quantum Systems held in Grenoble, June 16–July 4, 2003. To be published in *Lecture Notes in Mathematics*, Springer, New York.
- [JL] Jakšić, V., Last, Y.: A new proof of Poltoratskii's theorem. *J. Func. Anal.* **215**, 103 (2004).

- [JP1] Jakšić, V., Pillet, C.-A.: On a model for quantum friction II: Fermi's golden rule and dynamics at positive temperature. *Commun. Math. Phys.* **176**, 619 (1996).
- [JP2] Jakšić, V., Pillet, C.-A.: On a model for quantum friction III: Ergodic properties of the spin-boson system, *Commun. Math. Phys.* **178**, 627 (1996).
- [JP3] Jakšić, V., Pillet, C.-A.: Statistical mechanics of the FC oscillator. In preparation.
- [Ka] Kato, T.: *Perturbation Theory for Linear Operators*. Second edition. Springer, Berlin (1976).
- [Kat] Katznelson, A.: *An Introduction to Harmonic Analysis*. Dover, New York, (1976).
- [Koo] Koosis, P.: *Introduction to H_p Spaces*. Second edition. Cambridge University Press, New York (1998).
- [Kr] Kritchevski, E.: Ph.D. Thesis, McGill University. In preparation.
- [Maa] Maassen, H.: Quantum stochastic calculus with integral kernels. II. The Wigner-Weisskopf atom. Proceedings of the 1st World Congress of the Bernoulli Society, Vol. **1**(Tashkent, 1986), 491–494, VNU Sci. Press, Utrecht (1987).
- [LW] Kindenberg, K., West, B.J.: Statistical properties of quantum systems: the linear oscillator. *Phys. Rev. A* **30**, 568 (1984).
- [Meh] Mehta, M.L.: *Random Matrices*. Second edition. Academic Press, New York (1991).
- [Mes] Messiah, A.: *Quantum Mechanics. Volume II*. John Wiley & Sons, New York.
- [OY] Okamoto, T., Yajima, K.: Complex scaling technique in non-relativistic qed, *Ann. Inst. H. Poincaré* **42**, 311 (1985).
- [Pi] Pillet, C.-A.: Quantum dynamical systems. In *Open Quantum Systems I*. Lecture Notes of the Summer School on Open Quantum Systems held in Grenoble, June 16–July 4, 2003. To be published in *Lecture Notes in Mathematics*, Springer, New York.
- [Po] Poltoratskii, A.G.: The boundary behavior of pseudocontinuable functions. *St. Petersburg Math. J.* **5**, 389 (1994).
- [PSS] Paloviita, A., Suominen, K.-A., Stenholm, S.: Weisskopf-Wigner model for wave packet excitation. *J. Phys. B* **30**, 2623 (1997).
- [RS1] Reed, M., Simon, B.: *Methods of Modern Mathematical Physics, I. Functional Analysis*. Second edition. Academic Press, London (1980).
- [RS2] Reed, M., Simon, B.: *Methods of Modern Mathematical Physics, II. Fourier Analysis, Self-Adjointness*. Academic Press, London (1975).
- [RS3] Reed, M., Simon, B.: *Methods of Modern Mathematical Physics, III. Scattering Theory*. Academic Press, London (1978).
- [RS4] Reed, M., Simon, B.: *Methods of Modern Mathematical Physics, IV. Analysis of Operators*. Academic Press, London, (1978).
- [Ru] Rudin, W.: *Real and Complex Analysis*. 3rd edition. McGraw-Hill (1987).
- [Si1] Simon, B.: Spectral analysis of rank one perturbations and applications. CRM Lecture Notes Vol. **8**, pp. 109-149, AMS, Providence, RI (1995).
- [Si2] Simon, B.: Resonances in N-body quantum systems with dilation analytic potential and foundations of time-dependent perturbation theory. *Ann. Math.* **97**, 247 (1973).
- [SW] Simon, B., Wolff, T.: Singular continuous spectrum under rank one perturbations and localization for random Hamiltonians. *Comm. Pure Appl. Math.* **39**, 75 (1986).
- [VH] Van Hove, L.: Master equation and approach to equilibrium for quantum systems. In *Fundamental problems in statistical mechanics*, compiled by E.G.D. Cohen, North-Holland, Amsterdam (1962).
- [WW] Weisskopf, V., Wigner, E.: Berechnung der natürlichen Linienbreite auf Grund der Diracschen Lichttheorie. *Zeitschrift für Physik* **63**, 54 (1930).

- [DGM] De Groot, S.R., Mazur, P.: *Non-Equilibrium Thermodynamics*. North-Holland, Amsterdam (1969).