



HAL
open science

The RNA world: hypotheses, facts and experimental results.

Marie-Christine Maurel, Anne-Lise Haenni

► To cite this version:

Marie-Christine Maurel, Anne-Lise Haenni. The RNA world: hypotheses, facts and experimental results.. M. Gargaud, B. Barbier, H. Martin, J. Reisse. Lectures in Astrobiology. Vol 1, Springer-Verlag, pp.571-594, 2005, copyright Springer-Verlag. hal-00008134

HAL Id: hal-00008134

<https://hal.science/hal-00008134>

Submitted on 23 Aug 2005

HAL is a multi-disciplinary open access archive for the deposit and dissemination of scientific research documents, whether they are published or not. The documents may come from teaching and research institutions in France or abroad, or from public or private research centers.

L'archive ouverte pluridisciplinaire **HAL**, est destinée au dépôt et à la diffusion de documents scientifiques de niveau recherche, publiés ou non, émanant des établissements d'enseignement et de recherche français ou étrangers, des laboratoires publics ou privés.

The RNA world: Hypotheses, facts and experimental results

Marie-Christine Maurel and Anne-Lise Haenni

Institut Jacques-Monod-CNRS-Universités Paris 6 et Paris 7

Tour 43, 2 place Jussieu 75251 Paris. France

maurel@ijm.jussieu.fr

A biochemical world that would have existed before the contemporary DNA-RNA-Protein world, and baptized in 1986 «The RNA World» by Walter Gilbert (Gilbert, 1986), such a world had already been proposed during the preceding decades by Carl Woese, Francis Crick and Leslie Orgel (Woese, 1965; Crick, 1968; Orgel, 1968).

By demonstrating the remarkable diversity of the RNA molecule, Molecular Biology proved these predictions. RNA present in all living cells, performs structural and metabolic functions many of which were unsuspected only a few years ago. A truly modern «RNA world» exists in each cell; it contains RNAs in various forms, short and long fragments, single and double-stranded, endowed with multiple roles (informational, catalytic, that can serve as templates, guides, defense...), certain molecules being even capable of carrying out several of these functions.

Are the sources of this RNA world to be found in the bygone living world?

1. The modern RNA world

1.1 Where in the living cell is RNA found?

Synthesized (transcribed) in the nucleus, mature messenger RNAs (mRNAs), transfer RNAs (tRNAs) and ribosomal RNAs (rRNAs) are exported as single strands to the cytoplasm of the cell after various maturation steps. A ribonucleic acid (RNA) is formed by linking nucleotides¹, themselves composed of heterocyclic bases associated with a sugar, β -D-ribofuranose, and a phosphate molecule (phosphoric acid). The four main nucleotides contain the heterocyclic purine (adenine and guanine) or pyrimidine (cytosine and uracil) bases². However RNAs, in particular rRNAs and tRNAs contain a very large diversity of modified nucleotides, since more than a hundred modified nucleotides³ have now been identified in these two classes of molecules (Grosjean and Benne, 1998).

RNAs are usually single-stranded⁴. Nevertheless, these strands can base pair locally or over long stretches (intramolecular pairing). Finally, from a structural point of view, they contain a reactive hydroxyl group in the 2' position of the ribose (a group that is absent from DNA). The stacking forces and pairing of bases produce «stems and helices»; defined structures bring together the helices and the regions separating them, into «motifs».

¹ To yield a polyribonucleotide

² Adenine, A; guanine, G; cytosine, C; uracil, U

³ Post-transcriptional modifications

⁴ Paired *two-stranded* RNAs are exceptions found in a few rare viruses

RNA helices: Through the action of the stacking forces, the skeleton of the single strand by itself tends to take the shape of a simple, right-handed and irregular helix. However, the important conformation is the double helix composed of two strands of RNA or of RNA/DNA (hybrids formed transiently during transcription) or that occurs when two distantly located complementary segments of the same RNA base pair.

The *motifs* identified are bulges, elbows, or loops.

Hairpins are other important structural motifs related to certain functions of RNAs. They can lead to interactions with special sequences, such as the GNRA loops⁵, seven base-long loops, etc. Large RNAs possess independent domains formed by the arrangement of a certain number of motifs. An RNA molecule can adopt several reversible conformations, depending on the presence of ions, specific surfaces or bound ligands. RNAs possess a repertory of structures reminiscent of proteins (motifs or domains) allowing them to express certain functions such as catalysis. Finally, non Watson-Crick base pairs⁶ are frequently encountered in RNAs (G-U pairs are common) and modified bases are involved, and by their strong steric hindrance with the bases, the 2' OH groups of the ribose moieties tend to prevent folding in the B helical conformation⁷.

⁵ N is any nucleotide, R is a purine nucleotide

⁶ See Index. Watson-Crick pairings are the standard pairs (A-U and G-C)

⁷ The bends they impose to the plane of the bases – of about 20° – on the axis results in a structure resembling the A conformation (also designated RNA 11 to stress the 11 base pairs per turn). The A form of RNA double helices is characterized by 11 base pairs per helical turn (instead of 10 for the B form), and by bending of the base pairs by 16°/helical axis (instead of 20° for DNA A)

1.1.1 The three large classes of RNA

Messenger RNAs (mRNAs of 400 to 6 000 nucleotides) are the copy of DNA genes⁸. The RNA transcripts are considerably modified in the nucleus during maturation, and during transcription of DNA into RNA, short hybrids of the A conformation appear. Their life is short in prokaryotes (a few minutes to a few dozen minutes) and can be of several hours in higher eukaryotes; mRNAs correspond to only a few percent of the total cellular RNAs. The step by step decoding of the mRNA by the ribosome known as translation is regulated by specific proteins, and in some cases also by hairpin motifs and/or by pseudoknots (see chapter of Barbier, the origin of the genetic code). Pseudoknots result from base-pairing between nucleotides within a loop and complementary nucleotides outside of the loop.

Transfer RNAs (tRNAs) are small molecules whose maximum length is about 100 nucleotides. They are strongly conserved and are involved in the central metabolism of all types of cells. Their main function is to ensure the interaction between the codon presented by the mRNA and the specific amino acid corresponding to this codon and contained in the anticodon of the aminoacyl tRNA. tRNAs possess two extremely specific sites: the first is the sequence CCA located at the 3' OH of the molecule; the second site is located in a loop that contains the anticodon. The cloverleaf-shaped secondary structure (Fig. 1) possesses several motifs. tRNAs also serve as

⁸ A gene is a fragment of DNA whose information is expressed via the genetic code

primers during replication of certain viruses and are involved in the activity of telomerases. Synthesized as pre-tRNAs they undergo a maturation step during which RNAse P cleaves off a short fragment from the 5' end of the RNA (Guerrier-Takada *et al.*, 1983). As already mentioned, tRNAs contain a large number of modified bases that are probably the most visible «relics» of an ancient RNA world (Cermakian and Cedergren, 1998).

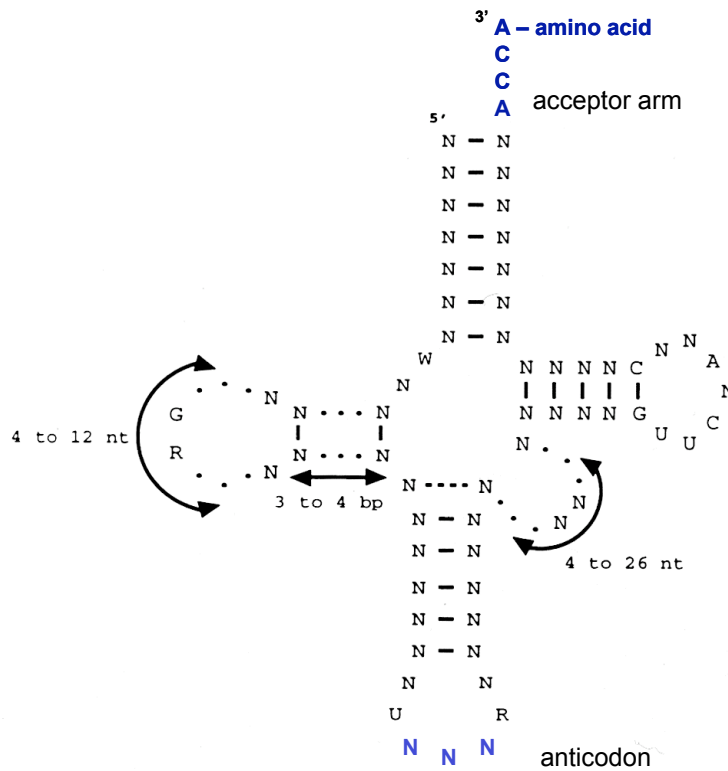

Fig. 1: Secondary cloverleaf structure of a tRNA. Arrows indicate number of nucleotides in the loop, stem and bulge.

The size of the *ribosomal RNAs* (rRNAs) is variable, from 120 to 4 718 nucleotides. rRNAs are located in the ribosome, the site of protein synthesis. In addition to about fifty proteins, the prokaryotic ribosome contains three rRNAs and the eukaryotic ribosome four rRNAs. The rRNAs are methylated (sometimes in the 2'OH position of the ribose, protecting the polymer from hydrolysis). Their typical secondary structure is remarkably conserved (Fig. 2).

They possess complex global tertiary conformations that compact the molecule into different domains, and it has now been clearly demonstrated that the rRNA catalyzes the formation of the peptide bond during protein biosynthesis (Ban *et al.*, 2000; Nissen *et al.*, 2000).

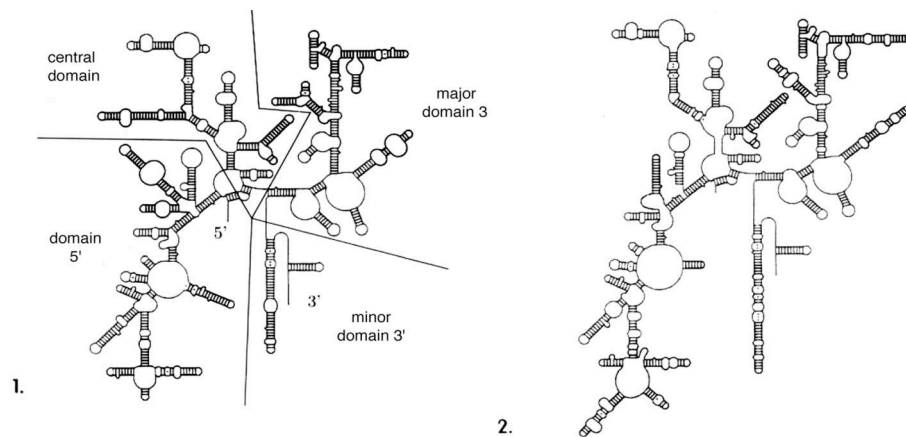

Fig. 2: Typical secondary structure
1) 16S rRNA of the bacterium *Escherichia coli*,
2) 18S rRNA of the yeast *Saccharomyces cerevisiae*.

1.1.2 Non-coding RNAs (NCRNAs)

In addition to rRNAs, tRNAs and mRNAs a variety of RNA molecules have been discovered that possess very diverse functions in the living cell (Maurel, 1992; Meli *et al.*, 2001; Zamore, 2002; Grosshans and Slack, 2002; Westhof, 2002). Before involvement of the ribosome, the RNA transcripts must undergo maturation steps. In eukaryotes, these post-transcriptional modification steps require the participation of small RNAs, the snoRNAs (*small nucleolar RNAs*) that together with proteins, form the snoRNP (*small nucleolar Ribonucleoprotein Particles*). Over 150 snoRNPs have been described in eukaryotes (in different lineages). They form a snoRNP complex, the snorposome, that participates in RNA maturation. The origin of the modification systems is still unknown. One of the various hypotheses put forward suggests that the snoRNAs of the RNA world would have been involved in the assembly of the protoribosomes, and more generally in the scaffolding of ribozymes (Terns and Terns, 2002).

Moreover, large snRNPs (*small nuclear Ribonucleoprotein Particles*) responsible for intron excision from pre-mRNAs have been identified. Each snRNP is composed of snRNA and about a dozen snRNP proteins. Two classes of such spliceosomes cleave different introns, whereas excision and ligation of the exons is achieved by the same biochemical mechanism (Tarn and Steitz, 1997). Spliceosomes are restricted to eukaryotes, even though bacteria have been reported that contain introns.

The telomerase is an enzyme that uses a small RNA as primer during replication to elongate the linear DNA located at the end of eukaryotic chromosomes (Maizels *et al.*, 1999).

Vault RNAs are ribonucleoprotein particles located in the cytoplasm of eukaryotes (Kong *et al.*, 2000). They are associated with the nuclear «pore complex»; their function has not been clearly defined, but their structure suggests that they may be involved in cell transport or in the assembly of macromolecules. The history of the evolution of Vault RNAs remains unknown, but these RNAs could have participated in primitive compartmentation.

Finally, an RNA-protein complex, the SrpRNA (*Signal recognition particle RNA*) is highly conserved in the three kingdoms (Wild *et al.*, 2002). It is involved in translation, and during secretion of proteins from the plasma membrane or from the endoplasmic reticulum.

About 15 years ago, the existence of a correcting mechanism, *editing*, was demonstrated (Lamond, 1988). This co- or post-transcriptional mechanism modifies the sequence of the mRNA by the insertion or deletion of nucleotides, or by the modification of bases. Up to 55 % modifications can take place with respect to the gene (in this case it is designated «cryptogene»). The sites where editing takes place are determined by the structure of the RNA, or by guide-RNAs (Stuart and Panigrahi, 2002). In kinetoplastid protozoa, guide RNAs are required to edit mitochondrial pre-mRNAs by in-

serting or deleting uridylate residues in precise sites (Kable *et al.*, 1997).

Finally, the tmRNA (*transfer-messenger RNA*) is a stable cytoplasmic RNA found in eubacteria. TmRNAs contain a tRNA^{Ala}-like structure (with pairing between the 5' and 3' ends) and an internal reading frame that codes for a short peptide (*peptide tag*) (Fig. 3). It is thus at variance with the strict definition of snRNAs, since it encompasses a short reading frame. It performs a new type of recently discovered translation, known as *trans-translation*, during which a peptide is synthesized starting from two distinct mRNAs. TmRNA acts as tRNA and as mRNA to «help» ribosomes that are blocked on a truncated mRNA lacking a termination codon. TmRNA participates by adding alanine to the growing peptide chain. Thus, tmRNA plays a dual role: as tRNA^{Ala} it can be aminoacylated by the corresponding alanyl-tRNA synthetase, and as mRNA its open reading frame can be translated by the ribosome (Withey and Friedman, 2002; Valle *et al.*, 2003). Could tmRNA be a bacterial adaptation, or could it have been lost by the archae and the eukaryae?

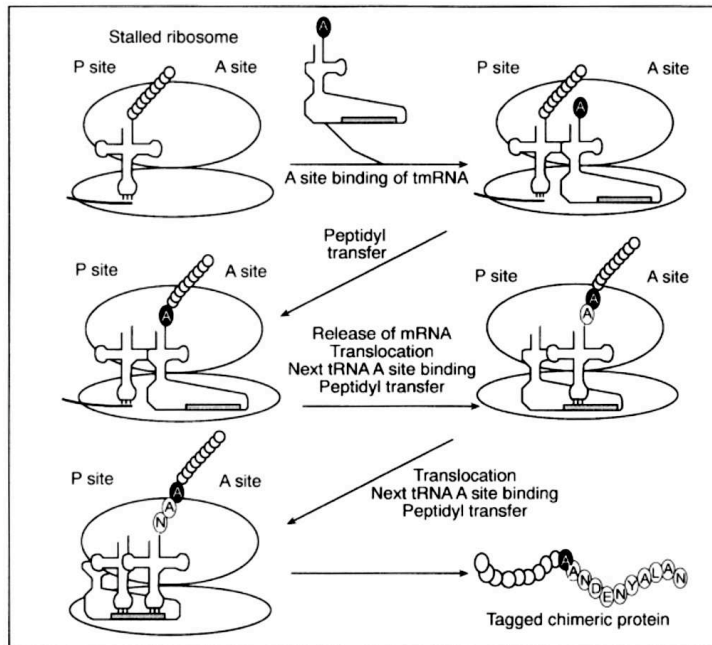

Fig. 3: How tmRNA functions.

A eukaryotic system distantly related to tmRNA has recently been described (Barends *et al.*, 2003) in the single-stranded Turnip yellow mosaic virus (TYMV) RNA. The 3' end of the viral genome harbors a tRNA-like structure that is indispensable for viability of the virus and can be valylated. During protein biosynthesis programmed with valylated TYMV RNA, the valine residue is N-terminally incorporated into the viral polyprotein, thereby introducing a novel mechanism of initiating protein synthesis (Fig. 4). Here again, the viral RNA would be bifunctional, serving both as tRNA and as mRNA.

It will be interesting to determine whether other viral RNAs whose 3' end bears an aminoacylatable tRNA-like structure (Fechter *et al.*, 2001) can also donate their amino acid for mRNA translation.

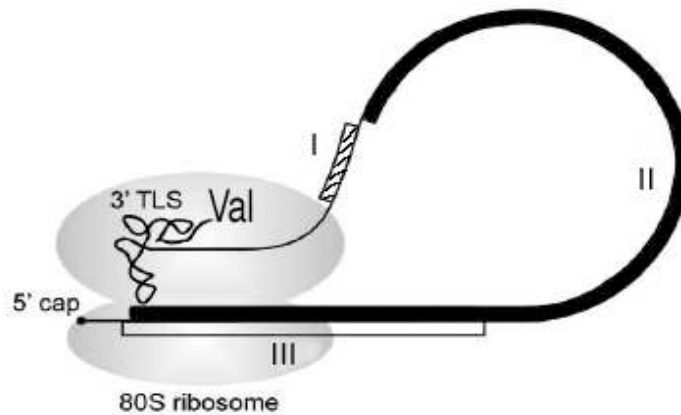

Fig. 4: Model of the tRNA-like structure-mediated internal initiation mechanism of TYMV RNA for polyprotein translation.

I : Coat protein gene

II: Polyprotein gene

III: Movement protein gene

Adapted from Barends *et al.*, 2003.

Viroids are subviral plant pathogens responsible for economically important diseases. They are small (246-401 nucleotides), single-stranded closed circular RNA molecules characterized by a highly compact secondary structure. They are devoid of coding capacity and replicate autonomously in the plant host. Two families of viroids have been characterized, the Pospiviroidae (type-member: Potato spindle tuber viroid, PSTVd) that replicates in the nucleus, and the Avsunviroidae (type-member: Avocado sun blotch viroid, ASBVd) that replicates in chloroplasts and possesses conserved hammerhead

structures in the viroid and in the complementary RNA orientation. It has been suggested that the presence of hammerhead structures could reflect the early appearance of viroids in the course of evolution; they could correspond to “living fossils” of the primitive RNA world (Diener, 2001).

The few ncRNAs described here are probably but the tip of a huge iceberg (Bachellerie *et al.*, 2002) since most of the transcriptional output of superior eukaryotes is non-protein coding (97% for human). These ncRNAs could constitute a real RNA world in complex organisms (Eddy, 2001; Mattick, 2003). Their study may open new perspectives about the importance of RNA in primitive life. Certain RNAs that are presently being investigated, are those involved in RNA interference (RNAi) : the RNAs responsible for RNAi are the small interfering RNAs that target and cleave mRNAs (Nykanen *et al.*, 2001). Micro RNAs, another class of small RNAs, are involved in translation regulation (Grosshans and Slack, 2002). In eukaryotes, guide snoRNAs participate in selecting the sites on rRNAs that undergo modifications such as Ψ formation or 2'-O-methylation (Lafontaine and Tollervey, 1998).

2. An RNA world at the origin of life?

The scenario of evolution postulates that an ancestral molecular world existed originally that was common to all the present forms of life; the functional properties of nucleic acids and proteins as we see

them today would have been produced by molecules of ribonucleic acids (Joyce, 1989; Orgel, 1989; Benner *et al.*, 1989, 1993; Joyce and Orgel, 1999; Gesteland *et al.*, 1999; Bartel and Unrau, 1999; McGinness *et al.*, 2002; Joyce, 2002).

2.1 Facts

As we have seen, RNAs occupy a pivotal role in the cell metabolism of all living organisms and several biochemical observations resulting from the study of contemporary metabolism should be stressed. For instance, throughout its life cycle, the cell produces deoxyribonucleotides required for the synthesis of DNA that derive from ribonucleotides of the RNA. Thymine a base specific of DNA is obtained by transformation (methylation) of uracil a base specific of RNA, and RNAs serve as obligatory primers during DNA synthesis (Fig. 5). Finally, the demonstration that RNAs act as catalysts is an additional argument in favor of the presence during evolution of RNAs before DNA.

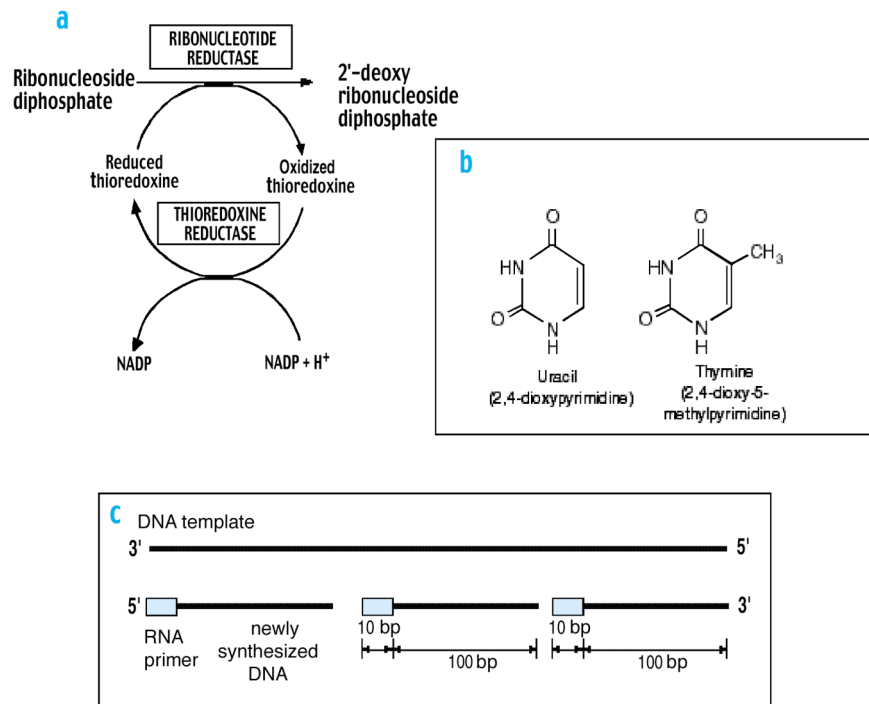

Fig. 5: Facts in favor of an RNA world.

a: Synthesis of deoxyribonucleotide

b: Structure of uracil and thymine

c: DNA synthesis primed by RNA.

2.2 Hypotheses

DNA replication triggered by ribonucleotide primers can be considered as a modified transcription process during which polymerisation of RNA is «replaced» by that of DNA. In addition, DNA a double-stranded molecule lacking a hydroxyl group in 2' of the desoxyfuranose, appears more stable than RNA. Therefore it seems

highly likely that RNA arose before DNA during biochemical evolution, and for this reason DNA is sometimes considered as modified RNA better suited for the conservation of genetic information. This genetic privilege would constitute a logical step in an evolutionary process during which other molecules could have preceded RNA and transmitted genetic information.

The idea of an «RNA» world rests primarily on three fundamental hypotheses, developed by Joyce and Orgel (1999):

- during a certain period in evolution, genetic continuity was assured by RNA replication;
- replication was based on Watson-Crick type base pairing;
- genetically coded proteins were not involved in catalysis.

2.3 But what do we know of primitive replication?

Synthesis of a strand complementary of the template was studied extremely thoroughly *in vitro* in the group of Orgel (Inoue and Orgel, 1983; Joyce and Orgel, 1986; Orgel, 1992). During this directed synthesis, the mononucleotides activated in the form of 5'-phosphorimidazolides are positioned according to the Watson and Crick pairing rules opposite a preformed polypyrimidine template. Since these monomers are activated, they can bind to one another to form the complementary strand (Fig. 6). Orgel and his coworkers showed that starting from activated monomers, it is possible in certain conditions to copy a large number of oligonucleotide sequences

containing one or two different nucleotides in the absence of enzyme (Hill *et al.*, 1993).

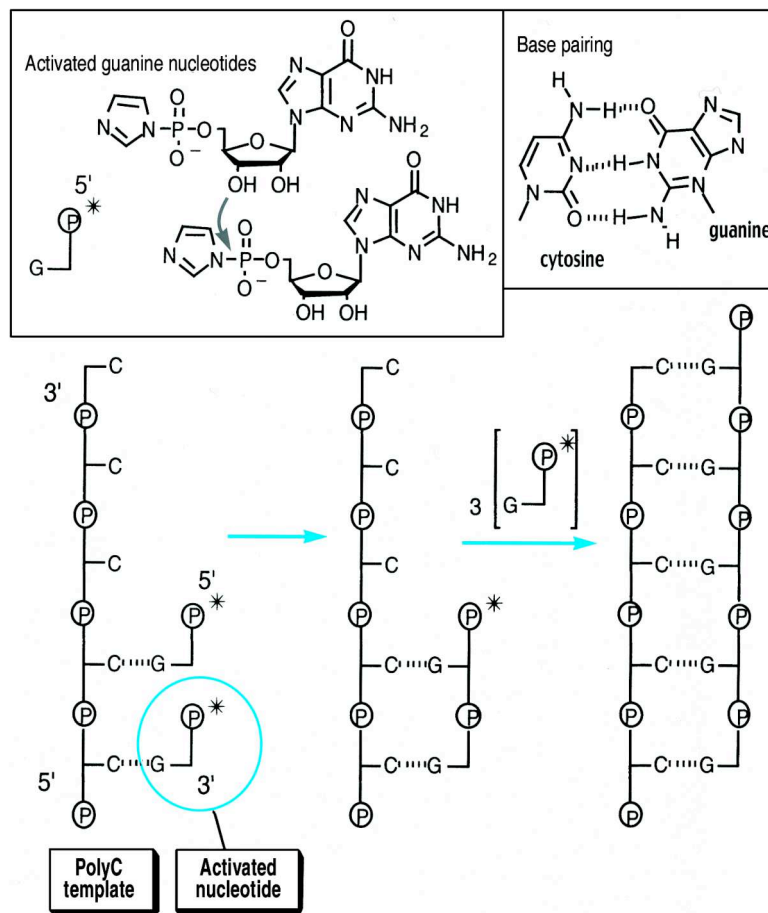

Fig. 6: Template-directed RNA synthesis.

Ferris and his coworkers spent some 15 years studying the assembly of RNA oligomers on the surface of montmorillonite (clay of Montmorillon in the Vienne region in France) (Ferris, 1987; Ferris and Ertem, 1992). The monomers used, nucleoside 5'

phosphorimidazolides, were probably not prebiotic molecules. Nevertheless, experimental results demonstrated that minerals which serve as adsorbing surfaces and as catalysts (Paecht-Horowitz *et al.*, 1970; Ferris *et al.*, 1996), can lead to accumulation of long oligonucleotides, given that activated monomers are available. One can thus envisage that activated mononucleotides assembled into oligomers on the montmorillonite surface or on an equivalent mineral surface. The longest strands serving as templates, direct synthesis of a complementary strand starting from monomers or short oligomers, and double-stranded RNA molecules accumulate. Finally, a double RNA helix of which one strand is endowed with RNA polymerase activity, would dissociate to copy the complementary strand to produce a second polymerase that would copy the first to produce a second complementary strand, and so forth. The RNA world would thus have emerged from a mixture of activated nucleotides. However, a mixture of activated nucleotides would need to have been available! In addition, this nucleotide chemistry is restricted in another way, since a copy of the template can be started only if the nucleotides are homochirals (Joyce *et al.*, 1987).

Finally, when either the first replicative molecule, the template or one of its elements (nucleotides) is to be synthesized from the original building blocks in particular the sugars that are constituents of nucleotides, a certain number of difficulties are encountered (Sutherland and Whitfield, 1997). Synthesis of the sugars from formaldehyde produces a complex mixture in which ribose is in low

amounts. On the other hand, production of a nucleoside from a base and a sugar leads to numerous isomers, and no synthesis of pyrimidine nucleosides has so far been achieved in prebiotic conditions. Finally, phosphorylation of nucleosides also tends to produce complex mixtures (Ferris, 1987). Onset of nucleic acid replication is nearly inconceivable if one does not envisage a simpler mechanism for the prebiotic synthesis of nucleotides. Eschenmoser succeeded in producing 2,4-diphosphate ribose during a potentially prebiotic reaction between glycol aldehyde⁹ monophosphate and formaldehyde (Eschenmoser, 1999). It is thus possible that direct prebiotic nucleotide synthesis can occur by an alternative chemical pathway. Nevertheless, it is more likely that a certain organized form of chemistry preceded the RNA world, hence the notion of «genetic take-over». Since the ribose-phosphate skeleton is theoretically not indispensable for the transfer of genetic information, it is logical to propose that a simpler replication system would have appeared before the RNA molecule.

3. A pre-RNA world

3.1 Evolutive usurpation

During the evolutionary process, a first genetic material, mineral in nature would have been replaced by another totally distinct mate-

⁹ Recently shown to exist in space (Cooper *et al.*, 2001)

rial of organic nature. The hypothesis of a precursor of nucleic acid¹⁰ (Cairns-Smith, 1966, 1982) is a relatively ancient idea, but it is only within the last few years that research has been oriented towards the study of simpler molecules than present day RNAs, yet capable of auto-replication. Models with predictably retroactive activities can thus be tested experimentally.

3.2 Alternative genetic systems

In the *Peptide Nucleic Acids* (PNA) of Nielsen and coworkers, the ribofuranose-phosphate skeleton is replaced by a polyamidic skeleton on which purine and pyrimidine bases are grafted (Fig. 7). PNAs form very stable double helices with an RNA or a complementary DNA (Egholm *et al.*, 1993) and can serve as template for the synthesis of RNA, or vice versa (Schmidt *et al.*, 1997). PNA-DNA chimeras containing two types of monomers have been produced on DNA or PNA templates (Koppitz *et al.*, 1998). The information can be transferred from PNAs (achiral monomers) to RNA during directed synthesis; the double helical molecule with a single complementary RNA strand is stable. Transition from a «PNA world» to an «RNA world» is hence possible. Nevertheless, the formation of oligomers from PNA monomers seems particularly difficult in prebiotic conditions.

¹⁰ This is the idea of genetic take-over developed by Cairns-Smith in the 60s

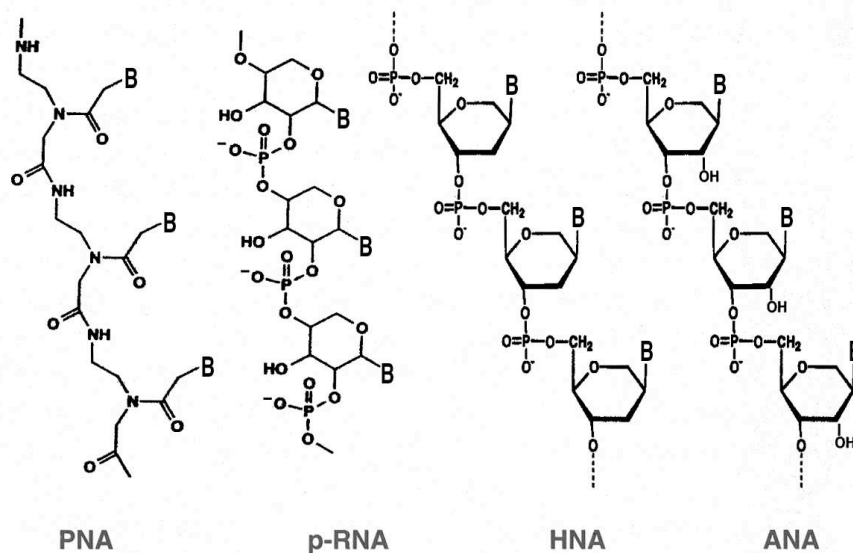

Fig. 7: Alternative genetic systems (B = base).

Eschenmoser (1994) explored the properties of nucleic acid analogues in which ribofuranose is replaced by one of its isomers, ribopyranose (Furanose, 5-membered ring; pyranose, 6-membered ring). p-RNAs (pyranosyl RNAs) (Fig. 7) form more stable double helices (with Watson-Crick pairings) than RNA with ribofuranose. In addition, the double helices of p-RNA wind and unwind more easily than those formed with standard nucleic acids, and this should facilitate their separation during replication. p-RNAs could therefore constitute good candidates as precursor genetic systems, but a p-RNA strand cannot pair with an RNA of complementary sequence, and this makes it difficult to imagine a transition from p-RNA to RNA.

The group of Eschenmoser recently replaced the ribose moiety by a four-carbon sugar, threose, whose prebiotic synthesis seems easier. The resulting oligonucleotides designated TNAs, (3'->2')- α -L-threose nucleic acid (Fig. 8), can form a double helix with RNA (Schöning *et al.*, 2000). TNA is capable of antiparallel, Watson-Crick pairing with complementary DNA, RNA and TNA oligonucleotides. Furthermore Szostak and his collaborators have recently found that certain DNA polymerases can copy limited stretches of a TNA template, despite significant differences in the sugar-phosphate backbone, (Chaput *et al.*, 2003).

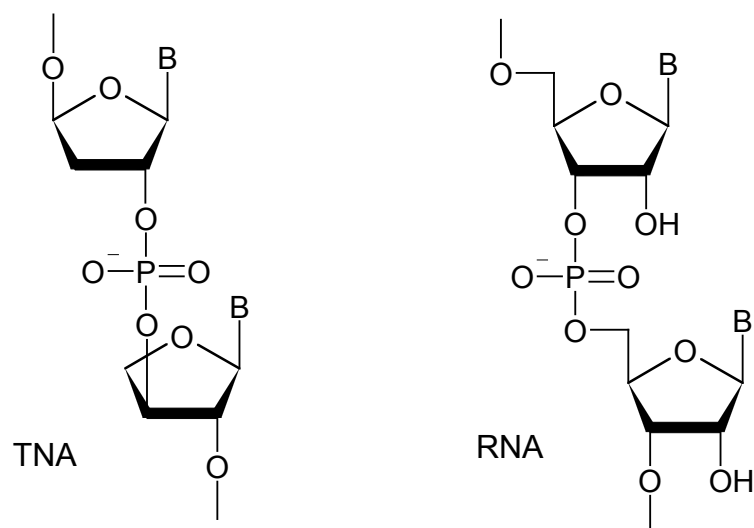

Fig. 8: Structure of TNA and RNA.

Finally, Hexitol Nucleic Acids (HNA) (Fig. 7), whose skeleton is composed of 1, 5-anhydrohexitol (six-membered cyclic hexitol) and their isomers Altritol Nucleic Acids (ANA), form stable duplexes

with complementary oligonucleotides, and are very efficient templates since they favor assembly of a complementary strand during directed synthesis (Kozlov *et al.*, 1999a, 1999b, 2000). The shape of the duplexes formed is reminiscent of that of DNA in the A form. Double-helical DNA is mainly in the B form¹¹, whereas the double helices of RNA in the DNA-RNA hybrids adopt the A form¹². Kozlov *et al.* (1999c) have demonstrated that the more the template is in the A form, the better the efficiency of directed synthesis. Based on these studies one can imagine an entire series of templates that would supply the «good» structural pre-organization. Furthermore, these same authors have shown that RNA partially pre-organized in the A form, is a more efficient matrix than single-stranded DNA. Finally, whatever the precursor skeleton adapted to the formation of stable duplexes may have been, the bond at the mineral surface could have imposed the necessary geometrical constraints: yet this still remains to be experimentally demonstrated.

This leads us to two major conclusions, namely that on one hand a transition may have occurred between two different systems without loss of information, and that on the other hand the HNA and ANA nucleic acids are very efficient templates. Even if it is difficult to imagine prebiotic synthesis of these molecules, they are good model

¹¹ d-ribose in the 2'-endo form. The characteristics of these forms are indicated above in the text

¹² In this case, the sugar is in the 3'-endo conformation. In the A form of RNA double helices, there are 11 base pairs per helical turn (instead of 10 for the B form); the inclination of the base pairs is 16°/helical axis (20° for DNA A)

systems that show the importance of a necessary structural pre-organization for directed synthesis by a template.

From the point of view of evolution, the studies described previously demonstrate that other molecules capable of transmitting hereditary information may have preceded our present day nucleic acids. This is what Cairns-Smith coined the «take-over» (Cairns-Smith, 1982), the evolutionary encroachment or genetic take-over, or to some extent what François Jacob (1970) calls genetic tinkering, in other words, making new material from the old. This also sheds light on the precision with which the various elements or processes progressively adjusted themselves, thanks to successive trials and errors.

4. Optimizing the functional capacities of ribonucleic acids

4.1 Coenzymes and modified nucleosides

The nucleotides that by post-transcriptional modification can today acquire the majority of functional groups present in amino acids, possess a great potential diversity that is expressed at the level of ribonucleotide coenzymes (several coenzymes derive from AMP), and of the modified bases of tRNAs (Fig. 9). The role of cofactors at all steps of the metabolism and their distribution within the three kingdoms suggest that a great variety of nucleotides was present in the ancestor common to all forms of life.

Several authors have underscored the possible presence of coenzymes before the appearance of the translation machinery (White, 1976). Proteins would have appeared only at a later stage, coenzymes and ribozymes being fossil traces of past catalysts. Indeed, in the living cell, only a minority of enzymes function without coenzyme; they are mostly hydrolases, and apart from this group, 70% of the enzymes require a coenzyme. If metal coenzymes involved in catalysis are considered, the number of enzymes that depend on coenzymes increases further. Present-day coenzymes, indispensable co-factors for many proteins, would be living fossils of catalysts of primitive metabolism.

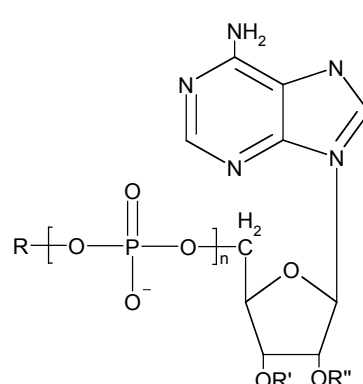

Coenzyme	R	R'	R''	n
Activated methionine	methionine	H	H	0
Amino acid adenylate	amino acid	H	H	1
Activated sulfate	SO ₃ ²⁻	H	PO ₃ ²⁻	1
Cyclic 3'-5' AMP	H	H	PO ₃ ²⁻	1
NAD		H	H	2
NADP		PO ₃ ²⁻	H	2
FAD		H	H	2
CoA-SH		H	H	2

Fig. 9: List of coenzymes derived from AMP.

Most coenzymes are nucleotides (NAD, NADP, FAD, coenzyme A, ATP...) or contain heterocyclic nitrogen bases that can originate

from nucleotides (thiamine pyrophosphate, tetrahydrofolate, pyridoxal phosphate, etc.).

Coenzymes would be vestiges of catalytic nucleic enzymes that preceded ribosomal protein synthesis, and tRNAs can be viewed as large coenzymes participating in the transfer of amino acids. It is even possible to consider that catalytic groups that were part of nucleic enzymes were incorporated in specific amino acids rather than being «retained» as coenzymes. This could be the case of imidazol, the functional group of histidine, whose present synthesis in the cell is triggered by a nucleotide.

The modified nucleosides present today in RNAs result from post-transcriptional modifications. Nevertheless, modified nucleosides could have been present in the primitive world and their distribution would have become established in the RNAs of the three living kingdoms (Cermakian and Cedergren, 1998).

Our working hypothesis is based on the demonstration of esterase activity in a nucleoside analogue N⁶-ribosyladenine (Fuller *et al.*, 1972; Maurel and Ninio, 1987). This activity which is due to the presence of an imidazol group that is free and available for catalysis, is comparable to that of histidine placed in the same conditions (Fig. 10). We have studied the kinetic behavior of this type of catalyst (Ricard *et al.*, 1996) and have shown that the catalytic effect increases greatly when the catalytic element, pseudohistidine, is placed in a favorable environment within a macromolecule (Décout

et al., 1995). Moreover, primitive nucleotides were not necessarily restricted to the standard nucleotides encountered today, and because of their replicative and catalytic properties, the N6 and N3 substituted derivatives of purines could have constituted essential links between the nucleic acid world and the protein world.

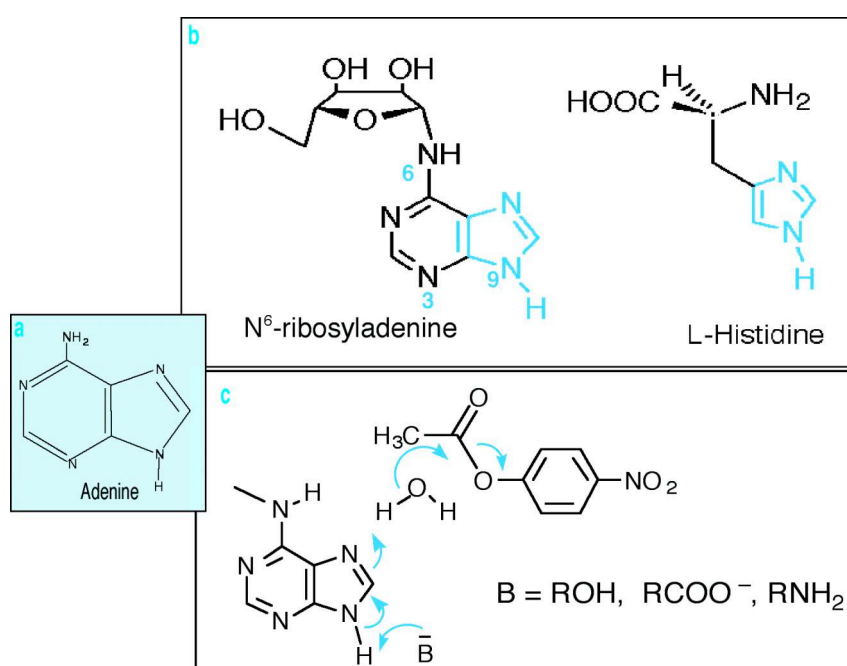

Fig.10: a: Adenine
 b: Comparison of modified adenosine and histidine
 c: Catalytic activity of adenine residue.

4.2 The case of adenine

Purine nucleotides, and in particular those containing adenine, participate in a large variety of cellular biochemical processes (Mau-

rel and Décout, 1999). Their best-known function is that of monomeric precursors of RNAs and DNAs. Nevertheless, derivatives of adenine are universal cofators. They serve in biological systems as source of energy (ATP), allosteric regulators of enzymatic activity and regulation signals (cyclic AMP). They are also found as acceptors during oxidative phosphorylation (ADP), as components of coenzymes (such as in FAD, NAD, NADP, coenzyme A), as transfer agents of methyl groups and of S-adenosylmethionine, as possible precursors of polyprenoids in C5 (adenosylhopane) (Neunlist *et al.*, 1987), and – last but not least – adenine 2451 conserved within the large rRNA in the three kingdoms, would be involved in acid-base catalysis during the formation of the peptide bond (Muth *et al.*, 2000). However this role of adenine has been refuted based on mutagenesis studies and phylogenetic comparisons (Muth *et al.*, 2001; Green and Lorsch, 2002).

On the other hand, biosynthesis of an amino acid, histidine, that would have appeared late in evolution, begins with 5-phosphoribosyl-1-phosphate (PRPP) that forms N'-(5-phosphoribosyl)-ATP by condensation with ATP. This reaction is akin to the initial reaction of purine biosynthesis. Finally, the ease with which purine bases are formed in prebiotic conditions¹³ (Orò, 1960) suggests that these bases were probably essential components of an early genetic system. The first genetic system was probably capable of forming base pairs of the Watson-Crick type, Hoogsteen

¹³ Purines have also been found in the meteorite Murchison

and other atypical associations, by hydrogen bonds as they still appear today in RNA. It probably contained a different skeleton from that of RNA, and no doubt also modified bases, thereby adding chemical functions, but also hydrophobic groups, and functions such as amine, thiol, imidazole, etc. Wächterhäuser (1988) also suggested novel pairings of the purine-purine type.

Originally, the principle probably rested on forced cooperation of genetic and functional components, rather than on selection by individual competition. It may have first entailed testing and improvements (learning by trial and error) of the informational content of the genes, *i. e.* linking the genotype (sequence) to the phenotype (shape). One can consider that in such a system the unforeseen was faced, so that the living organism would need to adapt favorably and rapidly.

4.3 Mimicking Darwinian evolution

Most of the «rational» biochemical approaches consist in deducing the active sequence of a nucleic acid or protein from a primary sequence, or in synthesizing a defined compound by modelling and structural analysis. However, «real life», that of our ancestors as also that of our cells, does not proceed in this manner. The hunters-gatherers of prehistory survived only thanks to their extraordinary capacity to recognize objects. In addition, survival of a population in a new environment is often linked to the appearance of a few variants to which random mutations conferred the power to adapt and

exploit the new situation to their advantage. Combinatorial methods, by modelling these observations¹⁴, have now become the alternative to the rational concept. Selection *in vitro* requires no information concerning the sequence of the molecules, and replaces the pre-established adjustments between the molecule and its target. What is needed, is to mimic the processes of evolution at the molecular level.

Indeed, it is known since the experiments of Spiegelman (1971) and his colleagues (Kramer *et al.*, 1974) that populations of different molecules capable of reproducing themselves in a hereditary manner, can evolve and adapt to an appropriate environment. Spiegelman, the inventor of non-natural selection indeed demonstrated in the 60s, that RNA populations can evolve when they replicate with the help of an enzyme, the replicase of the bacteriophage Q β . A population of macromolecules can thus comply with the prerequisites of Darwinian theory, and must find a form adapted to recognition of the target in a sufficiently rich population. Coexistence in the same entity of shape and sequence, can favor the emergence of favorable candidates by means of a selection step (linked to the shape) and an amplification step (linked to the sequence) at the end of this molecular evolutionary process. A selection of this type could have occurred during early molecular evolution, some 3.5 billion years ago...

¹⁴ And by giving access to many related molecules that can be sorted

The original polymers more or less related to RNA and formed in the primitive world must have randomly contained the A, U, G and C bases. There are over one million possible sequences for a decanucleotide composed of 10 monomers A, U, G, C, and over 10^{12} sequences for a polynucleotide of 20 monomers¹⁵. Nature does not appear to have exploited all the possible combinations before having reached the remarkable functional unity of the living world, and given the immense number of possibilities it is also useless to try to explore experimentally, one by one, all the potentially functional sequences.

The SELEX method (Systematic Evolution of Ligands by Exponential enrichment) (Tuerk and Gold, 1990) is an efficient, quasi automatic method based on repeated cycles of reproductive selection of those individuals that are best adapted to a given function. Established in the 90s, this method makes it possible to obtain new structures, aptamers, selected through their aptitude to recognize other molecules (Ellington and Szostak, 1990). Aptamers are capable of recognizing targets as small as metal ions, or as large as cells. They can interact with a great variety of molecules that are important for primitive metabolism, be they amino acids, porphyrines, nucleotide factors, coenzymes, small peptides and short oligonucleotides (Illan-gasekare and Yarus, 1997; Jadhav and Yarus, 2002; Joyce, 2002; McGinness *et al.*, 2002; Reader and Joyce, 2002).

¹⁵ For a nucleic acid of 200 nucleotides, 10^{120} different sequences are theoretically possible, and for a small protein containing 200 amino acids, 10^{280} arrangements are possible!

At the molecular level, the Darwinian behavior requires that a method of selection (RNA-aptamers), of amplification of selected species, and of mutations (introduction of variants in the population by means of mutations) be established. Through several cycles of selection, amplification and mutations, populations of molecules are «pushed» to evolve towards novel properties. The molecules presenting the best «aptitudes» are selected and a new generation will thereby see the day. Evolutionary processes performed experimentally thus make it possible for molecules to emerge that have not yet been produced by Nature, or allow the re-emergence of precursor molecules that have strongly diverged or naturally disappeared.

Fig. 11: The SELEX method (adapted from Wilson and Szostak, 1999).

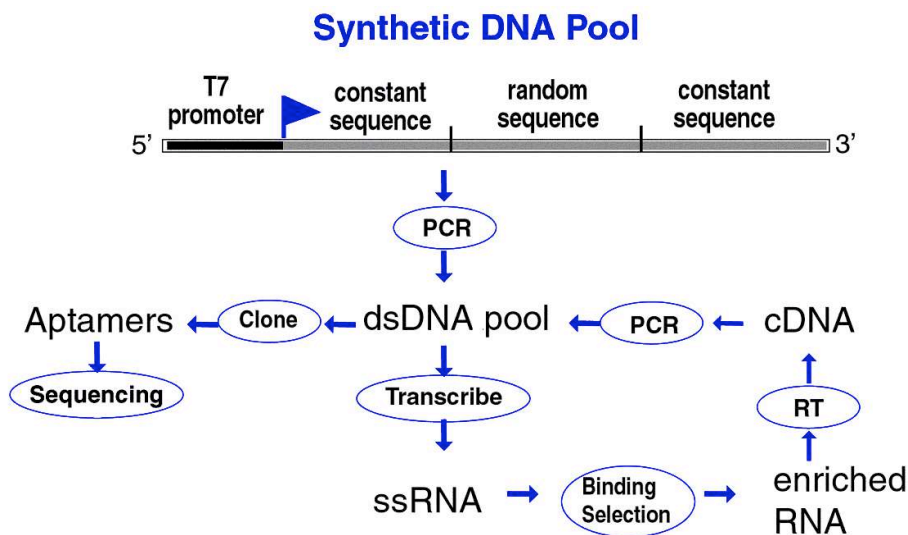

¹⁶ Which also applies to the protein world (phage display and combinatorial synthesis of peptides)

In practice, how does one proceed? A «bank» of oligonucleotides is a population of shapes among which a shape adapted to recognition of the target of interest is present (Fig. 11). The protocol is composed of five steps: the creation of double-stranded DNA carrying the random «box»¹⁶ flanked by regions required for amplification; transcription of this DNA into single-stranded RNA; selection; production of a DNA population by reverse transcription and PCR of the sequences retained during the selection step, then cloning and sequencing of the strands obtained after a certain number of selection and amplification cycles.

From a vast combination of nucleic acids, one can isolate aptamers that possess catalytic properties (RNA ligation, cleavage or synthesis of a peptide bond, transfer of an aminoacyl group, etc.). The first nucleic acids could possess independent domains, separated by flexible segments, creating reversible conformational motifs, dependent on ions and bound ligands. Thus, a 10 amino acid-long peptide can recognize fine structural differences within a micro RNA helix (discrimination can be made between two closely-placed microhelices). Just as protein and antibodies, RNA molecules can present hollows, cavities, or slits that make these specific molecular recognitions possible. RNAs must “behave as proteins”. Whatever the chronology and the order of appearance of the various classes of molecules, the importance lies in the shape, the scaffolding and the architecture that have allowed functional associations.

¹⁶ That is, a region of defined length, for instance of some 50 randomly aligned nucleotides

Starting from a heterogenous population of RNAs with 10^{15} variants (a population of 10^{15} different molecules) we have selected 5 populations of RNAs capable of specifically recognizing adenine after about ten generations (Meli *et al.*, 2002). When cloned, sequenced and modelled, the best one among the individuals of these populations, has a shape reminiscent of a claw capable of grasping adenine. Is it the exact copy of a primitive ribo-organism that feeds on prebiotic adenine in prebiotic conditions? Functional and structural studies presently under way will highlight other activities, other conformations...

Following this line of investigation we have selected two adenine-dependent ribozymes capable of triggering reversible cleavage reactions (Fig. 12). One of them is also active with imidazol alone. This result leads to very important perspectives (Meli *et al.*, 2003).

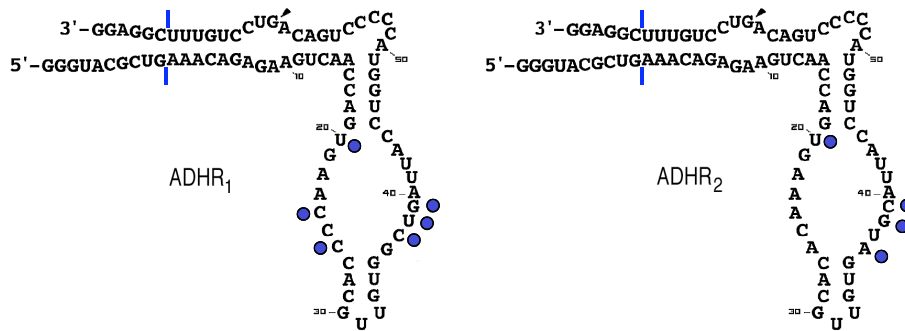

Fig 12: Adenine-dependent hairpin ribozymes (ADHR).

Arrowheads: cleavage sites

Grey dots: degenerated (mutated) sites

Vertical bars: separation between the primer binding region and the random sequence.

A considerable amount of research has been focused on the selection of ribozymes *in vitro*. Recently, it was demonstrated that a ribozyme is capable of continuous evolution, adding successively up to 3 nucleotides to the initial molecule (McGuinness, 2002). It is also possible to construct a ribozyme with only two different nucleotides, 2,6-diaminopurine and uracil (Reader and Joyce, 2002). Finally, Bartel and coworkers have selected a ribozyme-polymerase, capable of self-amplification (Johnston et al., 2001).

4.4 Other perspectives

Very little is known to date about the behavior of macromolecules in «extreme» environments. How do structures behave? What are the major modifications observed? What are the conditions of structural and functional stability? How are the dynamics of the macromolecules and their interactions affected? What are the possibilities of conserving biological macromolecules in very ancient soils or in meteorites? Can we find traces of these macromolecules as molecular biosignatures, and if so in what form (Maurel and Zaccari, 2001; Tehei *et al.*, 2002)?

The selection of thermohalophilic aptamers, RNAs resistant to high temperatures (80°C) in the presence of salt (halites 30 million years old), undertaken in our laboratory, will maybe allow us to an-

swer some of these questions, that are fundamental for the search of past traces of life, and of life on other planets...

5. Conclusion

The RNA world thus contains innumerable perspectives. The combination of methods available today are the best adapted to explore the vast combinations of nucleic acids but also of peptides. Will they make it possible to reconstitute the first steps of the living world? Attractive simulations may emerge, opening new evolutionary paths that have not been envisaged or that Nature has not yet explored.

The RNA world, at whatever step we situate it in the history of the living world, must be considered as a step in the history of life, an important step in the evolution of the contemporary cellular world. Because of its strong explanatory power, it also constitutes an important opening in the scientific study of the origin of life. Even if this concept does not explain how life appeared, it nevertheless promises a great number of experimental breakthroughs.

Acknowledgements : Figure 4 is reprinted from *Cell*, 2003,112, Bar-ends S., Bink H.H.J., van den Worm S.H.E., Pleij C.W.A., Kraal B. Entrapping ribosomes for viral translation: tRNA mimicry as a molecular trojan horse. Copyright 2003, with permission from Elsevier. We thank Dr. G.F Joyce for his constructive comments on the manuscript.

References:

- Bachellerie J.P., Cavaillé J., Hüttenhofer A. (2002). The expanding snoRNA world. *Biochimie*, **84**, 775-790.
- Ban N., Nissen P., Hansen J., Moore P.B., Steitz, T.A. (2000). The complete atomic structure of the large ribosomal subunit at 2.4 Å resolution. *Science*, **289**, 905-920.
- Barends S., Bink H.H.J., van den Worm S.H.E., Pleij C.W.A., Kraal B. (2003). Entrapping ribosomes for viral translation: tRNA mimicry as a molecular trojan horse. *Cell*, **112**, 123-129.
- Bartel D.P., Unrau P.J. (1999). Constructing an RNA world. *Trends Biochem. Sci.*, **24**, 9-13.
- Benner S.A., Ellington A.D., Tauer A. (1989). Modern metabolism as a palimpsest of the RNA world. *Proc. Natl. Acad. Sci. USA*, **86**, 7054-7058.
- Benner S.A., Cohen M.A., Gonnet G.H., Berkowitz D.B., Johnson K.P. (1993). Reading the palimpsest: contemporary biochemical data and the RNA World, in *The RNA World*, ed. Gesteland R.F. Atkins J.F. p. 27-70, Cold Spring Harbor Laboratory Press: Cold Spring Harbor NY.
- Cairns-Smith A.G. (1966). The origin of life and the nature of the primitive gene. *J. Theor. Biol.*, **10**, 53-88.
- Cairns-Smith A.G. (1982). *Genetic Takeover and the Mineral Origins of Life*, Cambridge University Press, Cambridge.
- Cermakian N., Cedergren, R. (1998). Modified nucleosides always were: an evolutionary model, in *Modification and Editing of RNA*,

ed. H. Grosjean and R. Benne, p. 535-541, ASM Press, Washington, D.C.

Chaput J.C., Szostak J.W. (2003). TNA synthesis by DNA polymerase. *J. Am. Chem. Soc.*, **125**, 9274-9275.

Cooper G., Kimmich N., Belisle W., Sarinana J., Brabham K., Garrel L. (2001). Sugar-related organic compounds in carbonaceous meteorites. *Nature*, **414**, 879-883.

Crick F.H. (1968). The origin of the genetic code. *J. Mol. Biol.* **38**, 367-379.

Décout J-L., Vergne J., Maurel M-C. (1995). Synthesis and catalytic activity of adenine containing polyamines. *Macromol. Chem. Phys.*, **196**, 2615-2624.

Diener TO. (2001). The viroid: biological oddity or evolutionary fossil? *Adv. Virus. Res.* **57**, 137-184.

Eddy S.R. (2001). Non-coding RNA genes and the modern RNA world. *Nature Reviews Genetic*, **2**, 919-929.

Egholm M., Buchardt O., Christensen L., Behrens C., Freier S.M., Driver D.A., Berg R.H., Kim S.K., Norden B., Nielsen P.E. (1993). PNA hybridizes to complementary oligonucleotides obeying the Watson-Crick hydrogen-bonding rules. *Nature*, **365**, 566-568.

Ellington, A.D., Szostak, J.W. (1990). In vitro selection of RNA molecules that bind specific ligands. *Nature*. **346**, 818-822.

Eschenmoser A. (1994). Chemistry of potentially prebiological natural products. *Origins Life Evol. Biosphere*, **24**, 389-423.

- Eschenmoser A. (1999). Chemical etiology of nucleic acid structure. *Science*, **284**, 2118-2124.
- Fechter P., Rudonger-Thirion J., Florentz C., Giegé R. (2001). Novel features in the tRNA-like world of plant viral RNAs. *Cell. Mol. Life. Sci.* **58**, 1547-1561.
- Ferris J.P. (1987). Prebiotic synthesis: problems and challenges *Cold Spring Harbor Symp. Quant. Biol.* **LII**, 29-39.
- Ferris J.P., Ertem G. (1992). Oligomerization of ribonucleotides on montmorillonite: reaction of the 5' phosphorimidazolidine of adenosine. *Science*, **257**, 1387-1389.
- Ferris J.P., Hill A.R., Liu R., Orgel L.E. (1996). Synthesis of long prebiotic oligomers on mineral surfaces. *Nature*, **381**, 59-61.
- Fuller W.D, Sanchez R.A, Orgel L.E. (1972). Studies in prebiotic synthesis. *J. Mol. Biol.*, **67**, 25-33.
- Gesteland R.F., Cech T.R., Atkins J.F. (ed) (1999). *The RNA World*, second edition, *Cold Spring Harbor Laboratory Press*, Cold Spring Harbor, NY.
- Gilbert W. (1986). The RNA world. *Nature*, **319**, 618.
- Guerrier-Takada C., Gardiner K., Marsh T., Pace N., Altman S. (1983). The RNA moiety of ribonuclease P is the catalytic subunit of the enzyme. *Cell*, **35**, 849-857.
- Green R., Lorsch J.R. (2002). The path to perdition is paved with protons. *Cell*, **110**, 665-668.
- Grosjean H., Benne R. (ed.) (1998). *Modification and Editing of RNA*, ASM Press, Washington, D.C.

- Grosshans H., Slack F.J. (2002). Micro-RNAs: small is plentiful. *J. Cell Biol.*, **156**, 17-21.
- Hill A.R., Orgel L.E., Wu T. (1993). The limits of template-directed synthesis with nucleoside-5'-phosphoro (2-methyl) imidazolides. *Orig. Life Evol. Biosphere*, **23**, 285-290.
- Illangasekare M., Yarus M. (1997). Small-molecule substrate interactions with a self aminoacylating ribozyme. *J. Mol. Evol.*, **54**, 298-311.
- Inoue T., Orgel L.E. (1983). A non-enzymatic RNA polymerase model. *Science*, **219**, 859-862.
- Jacob F. (1970). *La logique du vivant*, Gallimard, Paris.
- Jadahv V.R., Yarus M. (2002). Coenzymes as coribozymes. *Biochimie*, **84**, 877-888.
- Johnston W.K., Unrau P.J., Lawrence M.S., Glasner M.E., Bartel D.P. (2001). RNA-catalyzed RNA polymerization: Accurate and general RNA-templated primer extension. *Science*, **292**, 1319-1325.
- Joyce G.F., Orgel L.E. (1986). Non-enzymic template-directed synthesis on RNA random copolymers: poly (C,G) templates. *J. Mol. Biol.*, **188**, 433-441.
- Joyce G.F., Schwartz A.W., Miller S.L., Orgel L.E. (1987). The case for an ancestral genetic system involving simple analogues of the nucleotides. *Proc. Natl. Acad. Sci. USA*, **84**, 4398-4402.
- Joyce G.F. (1989). RNA evolution and the origins of life. *Nature*, **338**, 217-224.

Joyce G.F., Orgel L.E. (1999). Prospects for understanding the origin of the RNA world, in *The RNA World*, ed. Gesteland R.F., Cech T.R., Atkins J.F. p. 49-77, Cold Spring Harbor Laboratory Press: Cold Spring Harbor NY.

Joyce G.F. (2002). The antiquity of RNA-based evolution. *Nature*, **418**, 214-221.

Kable M.L., Heidmann S., Stuart K.D. (1997). RNA editing: getting U into RNA. *Trends Biochem. Sci.*, **22**, 162-166.

Kong L.B., Siva A.C., Kickhoefer V.A., Rome L.H., Stewart P.L. (2000). RNA location and modeling of a WD40 repeat domain within the vault. *RNA*, **6**, 890-900.

Koppitz M., Nielsen P.E., Orgel, L.E. (1998). Formation of oligonucleotide-PNA-chimeras by template-directed ligation. *J. Am. Chem. Soc.*, **120**, 4563-4569.

Kozlov I., Politis P.K., Pitsch S., Herdewijn P., Orgel L.E. (1999a). A highly enantio-selective hexitol nucleic acid template for nonenzymatic oligoguanylate synthesis. *J. Am. Chem. Soc.*, **121**, 1108-1109.

Kozlov I., De Bouvere B., Van Aerschot A. Herdewijn P., Orgel L.E. (1999b). Efficient transfer of information from hexitol nucleic acids to RNA during nonenzymatic oligomerization. *J. Am. Chem. Soc.*, **121**, 5856-5859.

Kozlov I., Politis P.K., Van Aerschot A. Busson R., Herdewijn P., Orgel L.E. (1999c). Nonenzymatic synthesis of RNA and DNA oli-

gomers on hexitol nucleic acid templates: the importance of A structure. *J. Am. Chem. Soc.*, **121**, 2653-2656.

Kozlov I., Zielinski M., Allart B., Kerremans L., Van Aerschot A., Busson R., Herdewijn P., Orgel, L.E. (2000). Nonenzymatic template-directed reactions on altritol oligomers, preorganized analogues of oligonucleotides. *Chem. Eur. J.*, **6**, 151-155.

Kramer F.R., Mills D.R., Cole P.E., Nishihara T., Spiegelman S. (1974). *J. Mol. Biol.*, **89**, 719-736.

Lafontaine D.L., Tollervey D. (1998). Birth of the snoRNPs: the evolution of the modification-guide snoRNAs. *Trends Biochem. Sci.*, **83**, 383-388.

Lamond A.I. (1988). RNA editing and the mysterious undecoded genes of trypanosomatid mitochondria. *Trends Biochem. Sci.*, **13**, 283-284.

Maizels N., Weiner A.M., Yue D., Shi P.Y. (1999). New evidence for the genomic tag hypothesis: archaeal CCA-adding enzymes and DNA substrates. *Biol. Bull.*, **196**, 331-333.

Mattick J.S. (2003). Challenging the dogma: the hidden layer of non-protein-coding RNAs in complex organisms. *BioEssays*, **25**, 930-939.

Maurel M.-C., Ninio J. (1987). Catalysis by a prebiotic nucleotide analog of histidine. *Biochimie*, **69**, 551-553.

Maurel M.-C. (1992). RNA in evolution. *J. Evol. Biol.*, **2**, 173-188.

Maurel M.-C., Décout J.-L. (1999). Origins of life: molecular foundations and new approaches. *Tetrahedron*, **55**, 3141-3182.

- Maurel M.-C., Zaccari G. (2001). Why Biologists should support the exploration of Mars. *BioEssays*, **23**, 977-978.
- McGinness K.E., Wright M.C., Joyce G.F. (2002). Continuous in vitro evolution of a ribozyme that catalyzes three successive nucleotidyl addition reactions. *Chem. Biol.*, **9**, 585-596.
- Meli M., Albert-Fournier B., Maurel M.-C. (2001). Recent findings in the modern RNA world. *Int. Microbio.* **4**, 5-11.
- Meli M., Vergne J., Décout J.-L., Maurel M.-C. (2002). Adenine-aptamer complexes. A bipartite RNA site which binds the adenine nucleic base. *J. Biol. Chem.*, **277**, 2104-2111.
- Meli M., Vergne J., Maurel M.-C. (2003). *In vitro* selection of adenine-dependent hairpin ribozymes. *J. Biol. Chem.*, **278**, 9835-9842.
- Muth G.W., Ortoleva-Donnelly L., Strobel S.A. (2000). A single adenosine with a neutral pKa in the ribosomal peptidyl transferase center. *Science*, **289**, 947-950.
- Muth G.W., Chen L., Kosek A.B. Strobel S.A. (2001). PH-dependent conformational flexibility within the ribosomal peptidyl transferase center. *RNA*, **7**, 1403-1415.
- Neunlist S., Bisseret P., Rohmer M. (1987). The hopanoids of the purple non-sulfur bacteria *Rhodopseudomonas palustris* and *Rhodopseudomonas acidophila* and the absolute configuration of bacteriohopanetetrol. *Eur. J. Biochem.*, **87**, 245-252.
- Nissen P., Hansen J., Ban N., Moore P.B., Steitz T.A. (2000). The structural basis of ribosome activity in peptide bond synthesis. *Science*, **289**, 920-930.

- Nykanen A., Haley B., Zamore P.D. (2001). ATP requirements and small interfering RNA structure in the RNA interference pathway. *Cell*, **107**, 309-321.
- Orgel L.E. (1968). Evolution of the genetic apparatus. *J. Mol. Biol.*, **38**, 381-393.
- Orgel L.E. (1989). Was RNA the first genetic polymer? in *Evolutionary tinkering in gene expression* ed. M. Grunberg-Manago *et al.*, p. 215-224, Plenum Press London.
- Orgel L.E. (1992). Molecular replication. *Nature*, **358**, 203-209.
- Orò J. (1960). *Biochem. Biophys. Res. Comm.*, **2**, 407-412.
- Paecht-Horowitz M., Berger J., Katchalsky A. (1970). Prebiotic synthesis of polypeptides by heterogeneous polycondensation of amino acid adenylates. *Nature*, **7**, 847-850.
- Reader J.S., Joyce G.F. (2002). A ribozyme composed of only two different nucleotides. *Nature*, **420**, 841-844.
- Ricard J., Vergne J., Décout J.-L., Maurel M.-C. (1996). The origin of kinetic cooperativity in prebiotic catalysts. *J. Mol. Evol.* **43**, 315-325.
- Schmidt J.G., Nielsen P.E., Orgel, L.E. (1997). Information transfer from peptide nucleic acid RNA by template-directed syntheses. *Nucl. Acids Res.*, **25**, 4797-4802.
- Schöning K.-U., Scholz P., Guntha S., Wu X., Krishnamurthy R., Eschenmoser A. (2000). Chemical etiology of nucleic acid structure: the α -threo-furanosyl-(3' \rightarrow 2') oligonucleotide system. *Science*, **290**, 1347-1351.

- Spiegelman S. (1971). An in vitro analysis of a replicating molecule. *Quarterly Review Biophys.*, **4**, 213-253.
- Stuart K., Panigrahi A.K. (2002). RNA editing: complexity and complications. *Mol. Microbiol.*, **45**, 591-596.
- Sutherland J.D., Whitfield J.N. (1997). Prebiotic chemistry: a bioorganic perspective. *Tetrahedron*, **53**, 11493-11527.
- Tarn W.Y., Steitz J.A. (1997). Pre-mRNA splicing: the discovery of a new spliceosome doubles the challenge. *Trends Biochem. Sci.*, **22**, 132-137.
- Tehei M., Franzetti B., Maurel M.-C., Vergne J., Hountondji C., Zaccari G. (2002). Salt and the search for traces of life. *Extremophiles*, **6**, 427-430.
- Terns M.P., Terns R.M. (2002). Small nucleolar RNAs: versatile trans-acting molecules of ancient evolutionary origin. *Gene Expr.*, **10**, 17-39.
- Tuerk, C., Gold, L., (1990). Systematic evolution of ligands by exponential enrichment: RNA ligands to bacteriophage T4 DNA polymerase. *Science*. **249**, 505-510.
- Valle M., Gillet R., Kaur S., Henne A., Ramakrishnan V., Frank J. (2003). Visualizing tmRNA entry into a stalled ribosome. *Science*, **300**, 127-130.
- Wächtershäuser G. (1988). An all-purine precursor of nucleic acids. *Proc. Natl. Acad. Sci. USA*, **85**, 1134-1135.
- Westhof E. (2002). Foreword. *Biochimie*, **84**, 687-689.

- White H.B. (1976). Coenzymes as fossils of an earlier metabolic state. *J. Mol. Evol.*, **7**, 101-104.
- Wild K., Weichenrieder O., Strub K., Sinning I., Cusack S. (2002). Towards the structure of the mammalian signal recognition particle. *Curr. Opinion Struct. Biol.*, **12**, 72-81.
- Wilson D.S., Szostak J.W. (1999). In vitro selection of functional nucleic acids. *Annu. Rev. Biochem.*, **68**, 611-647.
- Withey J.H., Friedman D.I. (2002). The biological roles of translation. *Curr. Opinion Microbiol.*, **5**, 154-159.
- Woese C.R. (1965). On the evolution of the genetic code. *Proc. Natl. Acad. Sci. USA.*, **54**, 1546-1552.