



**HAL**  
open science

## Two-scale homogenization of a hydrodynamic Elrod-Adams model

Guy Bayada, Sébastien Martin, Carlos Vazquez

► **To cite this version:**

Guy Bayada, Sébastien Martin, Carlos Vazquez. Two-scale homogenization of a hydrodynamic Elrod-Adams model. 2004. hal-00008080

**HAL Id: hal-00008080**

**<https://hal.science/hal-00008080>**

Preprint submitted on 20 Aug 2005

**HAL** is a multi-disciplinary open access archive for the deposit and dissemination of scientific research documents, whether they are published or not. The documents may come from teaching and research institutions in France or abroad, or from public or private research centers.

L'archive ouverte pluridisciplinaire **HAL**, est destinée au dépôt et à la diffusion de documents scientifiques de niveau recherche, publiés ou non, émanant des établissements d'enseignement et de recherche français ou étrangers, des laboratoires publics ou privés.

# Two-scale homogenization of a hydrodynamic Elrod-Adams model

G. Bayada

MAPLY CNRS UMR-5585 / LAMCOS CNRS UMR-5514, INSA Lyon, 69621 Villeurbanne cedex, France

S. Martin

MAPLY CNRS UMR-5585, INSA Lyon, 69621 Villeurbanne cedex, France

C. Vázquez

Dep. Matemáticas, Universidade A Coruña, Campus Elviña, 15071-A Coruña, España

**ABSTRACT** *The present paper deals with the analysis and homogenization of a lubrication problem, via two-scale convergence. We study in particular the Elrod-Adams problem with highly oscillating roughness effects.*

## 0 Statement of the problem

Cylindrical thin film bearings are commonly used for load support of rotating machinery. Fluid film bearings also introduce viscous damping that aids in reducing the amplitude of vibrations in operating machinery. A plain cylindrical journal bearing is made of an inner rotating cylinder and an outer cylinder. The two cylinders are closely spaced and the annular gap between the two cylinders is filled with some lubricant. The radial clearance is very small, typically  $\Delta r/r = 10^{-3}$  for oil lubricated bearings. The smallness of this ratio allows for a Cartesian coordinate to be located on the bearing surface. Thus, the Reynolds equation has been used for a long time to describe the behaviour of a viscous flow between two close surfaces in relative motion (see [37, 38] for historical references). The transition of the Stokes equation to the Reynolds equation has been proved by Bayada and Chambat in [11]. In dimensionless coordinates, it can be written as

$$\nabla \cdot (h^3 \nabla p) = \frac{\partial}{\partial x_1} (h),$$

where  $p$  is the pressure distribution, and  $h$  the height between the two surfaces.

Nevertheless, this modelling does not take into account cavitation phenomena: cavitation is defined as the rupture of the continuous film due to the formation of air bubbles and makes the Reynolds equation no longer valid in the cavitation area. In order to make it possible, various models have been used, the most popular perhaps being variational inequalities which have a strong mathematical basis but lack physical evidence. Thus, we use the Elrod-Adams model, which introduces the hypothesis that the cavitation region is a fluid-air mixture and an additional unknown  $\theta$  (the saturation of fluid in the mixture) (see [22, 24, 25, 28]). The model includes a modified Reynolds equation, here referred *exact Reynolds equation with cavitation* (see problem  $(\mathcal{P}_\theta)$  in the next section). From a mathematical point of view, the problem can be simplified using a *penalized Reynolds equation with cavitation* (see problem  $(\mathcal{P}_\eta)$  in the next section).

Homogenization process for lubrication problems is mainly related to the roughness of the surfaces. Let us mention that the Reynolds equation is still valid as long as  $\varepsilon/\sigma \gg 1$ ,  $\varepsilon$  being a small parameter describing the roughness spacing, and  $\sigma$  being the film thickness order (assumed to be small too) (see [12] for details). The study of surface roughness effects

in lubrication has gained an increasing attention from 1960 since it was thought to be an explanation for the unexpected load support in bearings.

Several methods have been used in order to study roughness effects in lubrication, the most popular perhaps being the flow factor method (see [35, 36, 41]), which is based on a formulation that is close to the initial one, only modified by flow factors related to anisotropic and microscopic effects.

So far this procedure has been used either by considering that no cavitation phenomena occur or using variational inequality models. Let us mention that the homogenization of cavitation models using variational inequalities has been studied in [16]. Recently many papers have discussed cavitation phenomena coupled with roughness effects, in mechanical engineering:

- A generalized computational formulation, by Shi and Salant [40], has been applied to the rotary lip seal and used to predict the performance characteristics over a range of shaft speeds.
- Intersperity cavitation has been studied in particular by Harp and Salant in [30] in order to derive a modified Reynolds equation with flow factors describing roughness effects and macroscopic cavitation.
- Modelling of cavitation has been pointed out in particular by Van Odyck and Venner in [42] in order to discuss the validity of the Elrod-Adams model and the formation of air bubbles leading to cavitation phenomena.

The above papers are based on averaging methods taking into account statistic roughness and are mainly heuristic. Our purpose, in the present paper, is to study in a rigorous way the limit of a three dimensional Stokes flow between two close rough surfaces using a double scale asymptotic expansion analysis (see for instance [14]) in the Elrod-Adams model.

The paper is organized as follows:

- Section 1 is devoted to the mathematical formulation of the lubrication problem: we briefly present the exact Elrod-Adams problem along with its penalized version. We also give the existence and uniqueness results corresponding to each problem. For this, we use a well-known penalization method to get the existence result. Uniqueness of the pressure is obtained using the doubling variable method of Kruřkov, which has been extended by Carrillo to the dam problem.
- Section 2 deals with the homogenization process: after some preliminaries on the two-scale technique, we first establish an uncomplete form of the homogenized problem in which an additional term in the direction perpendicular to the flow but also anisotropic phenomena on the saturation appear. In order to complete the homogenized problem, we introduce additional assumptions that lead us to consider particular but realistic cases: considering a separation of the microvariables on the gaps allows us to completely solve the difficulties previously mentioned; then, taking into account oblique roughness, we show that we obtain an intermediary case between the uncomplete problem (general case) and the complete problem (with the separation of the microvariables).
- Section 3 presents the numerical method and results which illustrate the main theorems established in the previous sections: we study longitudinal and transverse roughness cases.

## 1 Mathematical formulation

### 1.1 The lubrication problem

The dimensionless domain is denoted  $\Omega = ]0, 2\pi[ \times ]0, 1[$  and we suppose that the following assumptions are satisfied:

**Assumption 1.1**  $h \in C^1(\Omega)$  is  $2\pi x_1$  periodic and satisfies

$$\exists h_0, h_1, \quad \forall x \in \Omega, \quad 0 < h_0 \leq h(x) \leq h_1.$$

**Assumption 1.2**  $p_a$  is a Lipschitz continuous non-negative function,  $2\pi$  periodic.

Now let us introduce the Elrod-Adams model taking into account cavitation phenomena. Thus we introduce an *exact* problem and a *penalized* problem.

(i) *Exact Reynolds problem* - The strong formulation of the problem is given by the following set of equations:

$$\begin{cases} -\nabla \cdot (h^3(x) \nabla p(x)) = -\frac{\partial}{\partial x_1} (\theta(x) h(x)), & x \in \Omega \\ p(x) \geq 0, \quad p(x) (1 - \theta(x)) = 0, \quad 0 \leq \theta(x) \leq 1, & x \in \Omega \end{cases}$$

with the following boundary conditions:

$$\begin{aligned} p = 0 \text{ on } \Gamma_0 \text{ and } p = p_a \text{ on } \Gamma_a, & \quad (\text{Dirichlet conditions}) \\ \theta h - h^3 \frac{\partial p}{\partial x_1} \text{ and } p \text{ are } 2\pi x_1 \text{ periodic,} & \quad (\text{periodic conditions}) \end{aligned}$$

where  $\theta(x)$  is the normalized height of fluid between the two surfaces. The boundaries  $\Gamma_0$  and  $\Gamma_a$  are given on FIG.1. These boundary conditions are linked with a specific but wide type of bearings: journal bearings with a pressure imposed on the top and at the bottom. However, other boundary conditions can be considered.

The earlier problem can be formulated under a weak form as

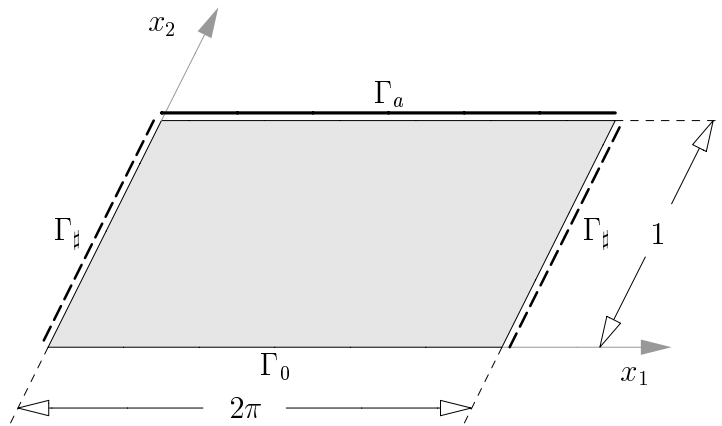

Figure 1: Normalized lubrication domain (with supply pressure)

$$(\mathcal{P}_\theta) \begin{cases} \text{Find } (p, \theta) \in V_a \times L^\infty(\Omega) \text{ such that:} \\ \int_{\Omega} h^3 \nabla p \nabla \phi = \int_{\Omega} \theta h \frac{\partial \phi}{\partial x_1}, \quad \forall \phi \in V_0, \\ p \geq 0, \quad p (1 - \theta) = 0, \quad 0 \leq \theta \leq 1, \quad \text{a.e. in } \Omega, \end{cases}$$

where the functional spaces are defined as

$$\begin{aligned} V_a &= \left\{ \phi \in H^1(\Omega), \phi \text{ is } 2\pi x_1 \text{ periodic, } \phi|_{\Gamma_0} = 0, \phi|_{\Gamma_a} = p_a \right\}, \\ V_0 &= \left\{ \phi \in H^1(\Omega), \phi \text{ is } 2\pi x_1 \text{ periodic, } \phi|_{\Gamma_0} = 0, \phi|_{\Gamma_a} = 0 \right\}. \end{aligned}$$

(ii) *Penalized Reynolds problem* - In the penalized problem, an approximate relationship between  $p$  and  $\theta$  is used. Defining the function

$$H_\eta(z) = \begin{cases} 0, & \text{if } z < 0, \\ z/\eta, & \text{if } 0 \leq z \leq \eta, \\ 1, & \text{if } z > \eta, \end{cases}$$

the weak formulation of the problem is given by

$$(\mathcal{P}_\eta) \begin{cases} \text{Find } p_\eta \in V_a, \text{ such that:} \\ \int_\Omega h^3 \nabla p_\eta \nabla \phi = \int_\Omega H_\eta(p_\eta) h \frac{\partial \phi}{\partial x_1}, \quad \forall \phi \in V_0, \\ p_\eta \geq 0, \quad \text{a.e. in } \Omega. \end{cases}$$

Hence,  $H_\eta(p_\eta)$  plays the role of the saturation function.

Let us mention that, by many aspects, the lubrication problem is close to the dam problem. The dam problem has first been stated using variational inequalities (see [7, 8, 9, 17]). But this approach is only possible for dams with vertical walls (typically rectangular dams). The formulation of the dam problem for domains with general shapes has been introduced by Alt, Brézis, Kinderlehrer and Stampacchia [2, 21]. Introducing the permeability of the porous medium, denoted  $k$ , the formulation is based on Darcy's law ([26] for historical references). The basic problem is to find the pressure  $p$  and the fluid saturation  $\theta$  in the domain. The main differences with the lubrication problem lie in the flow direction ( $x_1$  in the lubrication problem,  $x_2$  in the dam problem) and an additive sign condition on the fluid flow in the dam problem, designed to eliminate the non physical solutions and meaning that no water flows into the dam through the boundary in contact with the open air. Homogenization of the dam problem using the  $\Gamma$ -convergence has been partially studied by Rodrigues (see [39] and related references).

## 1.2 Existence and uniqueness results for $(\mathcal{P}_\eta)$

Let  $(\mathcal{P}_\eta^n)$  be the auxiliary problem defined by

$$(\mathcal{P}_\eta^n) \begin{cases} \text{Find } p_\eta^n \in V_a \text{ such that, } p_\eta^{n-1} \in V_a \text{ being given,} \\ \int_\Omega h^3 \nabla p_\eta^n \nabla \phi = \int_\Omega H_\eta(p_\eta^{n-1}) h \frac{\partial \phi}{\partial x_1}, \quad \forall \phi \in V_0. \end{cases}$$

**Lemma 1.3** *Under Assumptions 1.1 and 1.2, problem  $(\mathcal{P}_\eta^n)$  admits a unique solution  $p_\eta^n$ . Moreover, one has the following estimates:*

$$\left\| p_\eta^n \right\|_{H^1(\Omega)} \leq C,$$

where  $C$  does not depend on  $n$ .

*Proof.* Equivalently, with  $q_\eta^n(x_1, x_2) = p_\eta^n(x_1, x_2) - p_a(x_1)\psi(x)$  (with  $\psi(x) = x_2$  for example), one has to find  $q_\eta^n \in V_0$  such that

$$\int_{\Omega} h^3 \nabla q_\eta^n \nabla \phi = \int_{\Omega} H_\eta(p_\eta^{n-1}) h \frac{\partial \phi}{\partial x_1} - \int_{\Omega} h^3 \nabla (p_a \psi) \nabla \phi, \quad \forall \phi \in V_0.$$

Existence and uniqueness are consequences of Lax-Milgram's theorem. Estimates are obtained using  $q_\eta^n$  as a test function and Cauchy-Schwartz inequality, trace theorem and Poincaré-Friedrichs inequality. □

**Theorem 1.4** *Under Assumptions 1.1 and 1.2, problem  $(\mathcal{P}_\eta)$  admits a unique solution  $p_\eta$ .*

*Proof.*

■ Existence of a solution is obtained by studying the behaviour of  $p_\eta^n$  when  $n$  goes to  $+\infty$ . By estimates of Lemma 1.3, there exists  $p_\eta \in H^1(\Omega)$  such that, up to a subsequence,

$$p_\eta^n \rightharpoonup p_\eta, \quad \text{in } H^1(\Omega).$$

Consequently,

$$\int_{\Omega} h^3 \nabla p_\eta^n \nabla \phi \longrightarrow \int_{\Omega} h^3 \nabla p_\eta \nabla \phi,$$

for every  $\phi \in V_0$ .

As  $H^1(\Omega) \hookrightarrow L^2(\Omega)$  with compact injection and  $H_\eta$  is Lipschitz continuous, one has

$$\int_{\Omega} H_\eta(p_\eta^n) h \frac{\partial \phi}{\partial x_1} \longrightarrow \int_{\Omega} H_\eta(p_\eta) h \frac{\partial \phi}{\partial x_1},$$

for every  $\phi \in V_0$ . Then one has:

$$\int_{\Omega} h^3 \nabla p_\eta \nabla \phi = \int_{\Omega} H_\eta(p_\eta) h \frac{\partial \phi}{\partial x_1}, \quad \forall \phi \in V_0. \tag{1}$$

Moreover, by Theorem III.9 of [20],

$$p_\eta \in V_a. \tag{2}$$

From Equations (1) and (2), we deduce that  $p_\eta$  is a solution of  $(\mathcal{P}_\eta)$ .

■ Positivity of solutions is obtained by rewriting  $p_\eta$  as  $p_\eta = p_\eta^+ - p_\eta^-$  with

$$\begin{aligned} p_\eta^+ &= \max(p_\eta, 0), \\ p_\eta^- &= -\min(p_\eta, 0). \end{aligned}$$

It can be proved that  $p_\eta^- \in V_0$ . Using  $p_\eta^-$  as a test-function in the variational formulation (1), one has

$$\int_{\Omega} h^3 \left| \nabla p_\eta^- \right|^2 = 0.$$

Then  $p_\eta^- = 0$  a.e. and  $p_\eta \geq 0$  a.e. in  $\Omega$ .

■ Uniqueness of the solution is obtained using a particular test function (following an idea developed in [10]). Let  $p_1$  and  $p_2$  be two solutions of  $(\mathcal{P}_\eta)$ . Then  $q = p_1 - p_2$  satisfies:

$$\int_{\Omega} h^3 \nabla q \nabla \phi = \int_{\Omega} \left( H_\eta(p_1) - H_\eta(p_2) \right) h \frac{\partial \phi}{\partial x_1}, \quad \forall \phi \in V_0. \tag{3}$$

We consider the test function  $\phi = f_\delta(q)$ , where  $f_\delta$  is defined with the usual notation for the positive part of a function by

$$f_\delta(x) = \begin{cases} \left(1 - \frac{\delta}{x}\right)^+, & \text{if } x > 0, \\ 0, & \text{if } x \leq 0. \end{cases}$$

Since  $f_\delta$  is Lipschitz continuous,  $\phi = f_\delta(q) \in V_0$  (see [29]). Moreover, one has

$$\nabla \phi = \frac{\delta}{q^2} \chi_{[q>\delta]} \nabla q,$$

where  $\chi_A$  is the characteristic function, defined to be identically one on  $A$  and zero elsewhere. From Equation (3) and Assumption 1.1, we deduce:

$$\begin{aligned} h_0^3 \int_{x \in \Omega, q(x) > \delta} \frac{|\nabla q|^2}{q^2} \delta &\leq h_1 \int_{x \in \Omega, q(x) > \delta} \left( H_\eta(p_1) - H_\eta(p_2) \right) \frac{\partial q / \partial x_1}{q^2} \delta \\ &\leq \frac{h_1}{\eta} \int_{x \in \Omega, q(x) > \delta} \left| \frac{\partial q / \partial x_1}{q} \right| \delta. \end{aligned}$$

Then it follows:

$$\begin{aligned} h_0^3 \int_{\Omega} \left| \nabla \ln \left( 1 + \frac{(q - \delta)^+}{\delta} \right) \right|^2 &\leq \frac{h_1}{\eta} \int_{\Omega} \left| \frac{\partial}{\partial x_1} \ln \left( 1 + \frac{(q - \delta)^+}{\delta} \right) \right| \\ &\leq \frac{h_1}{\eta} \int_{\Omega} \left| \nabla \ln \left( 1 + \frac{(q - \delta)^+}{\delta} \right) \right|. \end{aligned}$$

Applying Poincaré's inequality we obtain:

$$\int_{\Omega} \left| \ln \left( 1 + \frac{(q - \delta)^+}{\delta} \right) \right|^2 \leq C,$$

where  $C$  depends on  $h_0$ ,  $h_1$ ,  $|\Omega|$  and  $\eta$  but does not depend on  $\delta$ . Then letting  $\delta \rightarrow 0$ ,

$$q(x) \leq 0, \quad \text{a.e. in } \Omega.$$

Exchanging the roles of  $p_1$  and  $p_2$  gives  $q(x) \geq 0$  a.e. in  $\Omega$  so that, finally,  $q = p_1 - p_2 = 0$  a.e. in  $\Omega$ .  $\square$

### 1.3 Existence and uniqueness results for $(\mathcal{P}_\theta)$

**Theorem 1.5** *Under Assumptions 1.1 and 1.2, problem  $(\mathcal{P}_\theta)$  admits at least one solution.*

*Proof.* Existence of a solution is obtained by studying the behaviour of  $p_\eta$  when  $\eta$  goes to 0. First, let us notice that the following estimates hold:

$$\begin{aligned} \left\| H_\eta(p^\eta) \right\|_{L^\infty(\Omega)} &\leq C_1, \\ \left\| p^\eta \right\|_{H^1(\Omega)} &\leq C_2, \end{aligned}$$

where  $C_1$  and  $C_2$  do not depend on  $\eta$ . Indeed, they are easily obtained by considering the properties of  $H_\eta$  and using  $p_\eta - p_a \psi$  as a test function. From the earlier estimates, one has:

(i)  $\exists \theta \in L^\infty(\Omega)$ ,  $H_\eta(p_\eta) \rightharpoonup \theta$ , in  $L^\infty(\Omega)$  weak- $\star$ . In particular,

$$\int_{\Omega} H_\eta(p_\eta) h \frac{\partial \phi}{\partial x_1} \longrightarrow \int_{\Omega} \theta h \frac{\partial \phi}{\partial x_1}, \quad \forall \phi \in V_0,$$

(ii)  $\exists p \in H^1(\Omega)$ ,  $p_\eta \rightharpoonup p$ , in  $H^1(\Omega)$  and  $p_\eta \rightarrow p$ , in  $L^2(\Omega)$ . In particular,

$$\int_{\Omega} h^3 \nabla p_\eta \nabla \phi \longrightarrow \int_{\Omega} h^3 \nabla p \nabla \phi, \quad \forall \phi \in V_0.$$

From (i) and (ii), we deduce

$$\int_{\Omega} h^3 \nabla p_\eta \nabla \phi \, dx = \int_{\Omega} H_\eta(p_\eta) h \frac{\partial \phi}{\partial x_1}, \quad \forall \phi \in V_0.$$

Moreover, considering Theorem III.9 of [20],  $p \in V_a$ . It remains to prove the following properties to complete the proof of existence of a solution for the initial problem  $(\mathcal{P}_\theta)$ :

$$\begin{aligned} (i) \quad & p \geq 0, & \text{a.e. in } \Omega, \\ (ii) \quad & 0 \leq \theta \leq 1, & \text{a.e. in } \Omega, \\ (iii) \quad & p(1 - \theta) = 0, & \text{a.e. in } \Omega. \end{aligned}$$

■ Proof of (i) is deduced from positivity of  $p_\eta$  (see Lemma 1.4) and strong convergence of  $p_\eta$  to  $p$  in  $L^2(\Omega)$ .

■ Proof of (ii) is obtained considering the properties of the weak- $\star$  convergence (see Proposition III.12. in [20]). Since we have

$$H_\eta(p_\eta) \rightharpoonup \theta, \quad \text{in } L^\infty(\Omega) \text{ weak-}\star,$$

then,  $\|\theta\|_{L^\infty(\Omega)} \leq \liminf \|H_\eta(p_\eta)\|_{L^\infty(\Omega)} \leq 1$ , and finally,

$$\theta \leq 1, \quad \text{a.e. in } \Omega.$$

Let us prove that  $\theta \geq 0$  a.e. We settle  $\chi_\eta = 1 - H_\eta(p_\eta)$ . We have  $\|\chi_\eta\|_{L^\infty(\Omega)} \leq 1$  and

$$\exists \chi \in L^\infty(\Omega), \chi_\eta \rightharpoonup \chi, \quad \text{in } L^\infty(\Omega) \text{ weak-}\star.$$

The weak- $\star$  topology is separated. Then  $\chi = 1 - \theta$  and we have the following property:

$$\|\chi\|_{L^\infty(\Omega)} \leq \liminf \|\chi_\eta\|_{L^\infty(\Omega)} \leq 1,$$

which can be rewritten as

$$\|1 - \theta\|_{L^\infty(\Omega)} \leq 1, \quad \text{i.e.} \quad \theta \geq 0, \quad \text{a.e. in } \Omega.$$

■ Proof of (iii) is obtained with the following method: let  $H$  denote the Heaviside graph. Since  $p_\eta \geq 0$  (see Lemma 1.4), the following property holds:

$$(1 - H(p_\eta)) p_\eta = 0.$$

From this, we have  $p_\eta(1 - H_\eta(p_\eta)) = p_\eta(H(p_\eta) - H_\eta(p_\eta))$ . This term is analyzed in two steps:



- 1st step - Let  $\phi$  be a function in  $L^2(\Omega)$ . Then,

$$\left| \int_{\Omega} p_{\eta} (1 - H_{\eta}(p_{\eta})) \phi - p (1 - \theta) \phi \right| = \left| \int_{\Omega} (p_{\eta} - p) (1 - H_{\eta}(p_{\eta})) \phi + \int_{\Omega} p (\theta - H_{\eta}(p_{\eta})) \phi \right|.$$

Using Cauchy-Schwarz inequality,

$$\left| \int_{\Omega} p_{\eta} (1 - H_{\eta}(p_{\eta})) \phi - p (1 - \theta) \phi \right| \leq \|p_{\eta} - p\|_{L^2(\Omega)} \|\phi\|_{L^2(\Omega)} + \left| \int_{\Omega} p (\theta - H_{\eta}(p_{\eta})) \phi \right|.$$

With the  $L^2$  strong convergence of  $p_{\eta}$  to  $p$  and the weak- $\star$  convergence of  $1 - H_{\eta}(p_{\eta})$  to  $1 - \theta$ , since  $p \phi \in L^1(\Omega)$ , we get

$$\left| \int_{\Omega} p_{\eta} (1 - H_{\eta}(p_{\eta})) \phi - p (1 - \theta) \phi \right| \longrightarrow 0.$$

We have proved that

$$p_{\eta} (1 - H_{\eta}(p_{\eta})) \rightharpoonup p (1 - \theta), \quad \text{in } L^2(\Omega).$$

- 2nd step - Let  $\phi$  be a function in  $L^2(\Omega)$ . Then, by construction of  $H_{\eta}$ ,

$$\begin{aligned} \left| \int_{\Omega} p_{\eta} \left( H(p_{\eta}) - H_{\eta}(p_{\eta}) \right) \phi \right| &= \left| \int_{\Omega^{\eta}} p_{\eta} \left( 1 - \frac{p_{\eta}}{\eta} \right) \phi \right| \\ &\leq \left| \int_{\Omega^{\eta}} \eta \phi \right| \leq \eta \int_{\Omega} |\phi|. \end{aligned}$$

with  $\Omega^{\eta} = \{x \in \Omega, 0 \leq p_{\eta}(x) \leq \eta\}$ . We have proved that

$$\left( H(p_{\eta}) - H_{\eta}(p_{\eta}) \right) p_{\eta} \rightharpoonup 0, \quad \text{in } L^2(\Omega).$$

From uniqueness of the weak limit in  $L^2(\Omega)$  and the results stated in the two previous steps, we deduce:

$$p (1 - \theta) = 0, \quad \text{in } L^2(\Omega).$$

□

We state a uniqueness result following an idea widely developed by Alvarez and Oujja in [5] for the unstationary case. The uniqueness result is based on a monotonicity result when comparing the value of two solutions on the upper boundary. Thus we first establish the following lemma:

**Lemma 1.6** *Let  $(p_1, \theta_1)$  and  $(p_2, \theta_2)$  two solutions of  $(\mathcal{P}_{\theta})$  with respective pressure boundary values  $p_a^1$  and  $p_a^2$  on  $\Gamma_a$ . Then,*

$$\int_{\Omega} h^3(x_1, x_2) \frac{\partial(p_1 - p_2)^+}{\partial y} \xi'(x_2) dx \leq 0, \quad \forall \xi \in \mathcal{D}^+(0, 1).$$

*Proof.*

■ **1st step: Test functions**

Let  $X = (x_1, x_2)$  and  $X' = (x'_1, x'_2)$  be two pairs of variables and let us define the following function:

$$\phi(X, X') = \xi \left( \frac{x_2 + x'_2}{2} \right) \rho_{\varepsilon} \left( \frac{x_2 - x'_2}{2} \right) \hat{\rho}_{\varepsilon'} \left( \frac{x_1 - x'_1}{2} \right),$$

where  $\xi \in \mathcal{D}^+(0, 1)$ ,  $\rho_\varepsilon(r) = \frac{1}{\varepsilon} \rho\left(\frac{r}{\varepsilon}\right)$ ,  $\hat{\rho}_{\varepsilon'}(r) = \frac{1}{\varepsilon'} \hat{\rho}\left(\frac{r}{\varepsilon'}\right)$ .  $\rho$  and  $\hat{\rho}$  are functions with supports in  $(-1, 1)$ .

If  $0 < \varepsilon < \text{dist}(\text{Supp}\xi, \partial[0, 1])$ , then the functions  $\phi(X, \cdot)$  and  $\phi(\cdot, X')$  vanish on the boundary  $\Gamma_0 \cup \Gamma_a$  (see [4] for the details and [5]). Moreover, in order to get a  $2\pi x_1$  periodic function, we choose an even function  $\hat{\rho}_{\varepsilon'}$  and redefine it when  $(x_1, x'_1)$  belongs to the subset

$$T_{\varepsilon'} \cup S_{\varepsilon'} = \left\{ (x_1, x'_1) \in [0, 2\pi] \times [0, 2\pi], \quad |x_1 - x'_1| \geq 2\pi - 2\varepsilon' \right\},$$

by setting

$$\hat{\rho}_{\varepsilon'}\left(\frac{x_1 - x'_1}{2}\right) = \hat{\rho}_{\varepsilon'}\left(\frac{|x_1 - x'_1| - 2\pi}{2}\right).$$

Then we define the following function:

$$\eta_\nu(X, X') = \min \left[ \frac{(p_1(X) - p_2(X'))^+}{\nu}, \phi(X, X') \right].$$

Thus, for fixed  $X'$  (resp.  $X$ ),  $\eta_\nu(\cdot, X')$  (resp.  $\eta_\nu(X, \cdot)$ ) belongs to  $V_0$ .

### ■ 2nd step: Integral equality

Let us denote  $\Omega_1$  and  $\nabla_1$  (resp.  $\Omega_2$  and  $\nabla_2$ ) the domain and the gradient vector for the variable  $X$  (resp.  $X'$ ). For fixed  $X'$ , let us use  $\eta_\nu(\cdot, X')$  as a test function in the variational formulation of  $(\mathcal{P}_\theta)$  with the variable  $X$ :

$$\int_{\Omega_1} h^3(X) \nabla_1 [p_1(X)] \nabla_1 [\eta_\nu(X, X')] dX = \int_{\Omega_1} \theta_1(X) h(X) \frac{\partial}{\partial x_1} [\eta_\nu(X, X')] dX.$$

Integrating the previous equation on  $\Omega_2$  gives us a first integral equality on  $Q = \Omega_1 \times \Omega_2$ . Applying the same method to the variable  $X'$  (and exchanging the roles of  $X$  and  $X'$ ), we get a second integral equality. Then from periodicity and boundary conditions, it is possible to establish:

$$\begin{aligned} \int_Q \left[ h^3(X) (\nabla_1 + \nabla_2)(p_1) - h^3(X') (\nabla_1 + \nabla_2)(p_2) \right] (\nabla_1 + \nabla_2)(\eta_\nu) dX dX' \\ = \int_Q \left( h(X) - h(X') \theta_2(X') \right) \left( \frac{\partial}{\partial x_1} + \frac{\partial}{\partial x'_1} \right) (\eta_\nu) dX dX'. \end{aligned}$$

### ■ 3rd step: Change of variables

We make the following change of variables:

$$z = \frac{X + X'}{2}, \quad \sigma = \frac{X - X'}{2}.$$

The integral equality becomes:

$$\begin{aligned} \int_{Q_{z,\sigma}} \left[ h^3(z + \sigma) \nabla_z (p_1(z + \sigma)) - h^3(z - \sigma) \nabla_z (p_2(z - \sigma)) \right] \nabla_z (\eta_\nu(z + \sigma, z - \sigma)) dz d\sigma \\ = \int_{Q_{z,\sigma}} \left( h(z + \sigma) - h(z - \sigma) \theta_2(z - \sigma) \right) \frac{\partial}{\partial z_1} (\eta_\nu(z + \sigma, z - \sigma)) dz d\sigma, \end{aligned}$$

where  $Q_{z,\sigma}$  is the image of the domain  $Q$  through the change of variables.

Let us consider the sets:

$$A_\nu = \left\{ (z, \sigma) \in Q_{z, \sigma}, \frac{(p_1(z + \sigma) - p_2(z - \sigma))^+}{\nu} > \phi(z + \sigma, z - \sigma) \right\},$$

$$B_\nu = \left\{ (z, \sigma) \in Q_{z, \sigma}, \frac{(p_1(z + \sigma) - p_2(z - \sigma))^+}{\nu} \leq \phi(z + \sigma, z - \sigma) \right\}.$$

Let us denote  $I_1$  (resp.  $I_2$ ) the contribution of  $A_\nu$  (resp.  $B_\nu$ ) in the first integral and let us denote  $J_1$  (resp.  $J_2$ ) the contribution of  $A_\nu$  (resp.  $B_\nu$ ) in the second integral. Then we have:  $I_1 + I_2 = J_1 + J_2$ .

#### ■ 4th step: Study of the integrals

• Let us study  $J_1$ : since  $\phi$  does not depend on  $z_1$ , one gets:  $J_1 = 0$ .

• Let us study  $J_2$ :

$$\begin{aligned} J_2 &= \int_{B_\nu} \left( h(z + \sigma) - h(z - \sigma) \theta_2 \right) \frac{\partial}{\partial z_1} \left( \frac{(p_1 - p_2)^+}{\nu} \right) dz d\sigma \\ &= \int_{B_\nu} \left( h(z + \sigma) - h(z - \sigma) \right) \frac{\partial}{\partial z_1} \left( \frac{(p_1 - p_2)^+}{\nu} \right) dz d\sigma \\ &\quad + \int_{B_\nu} h(z - \sigma) (1 - \theta_2) \frac{\partial}{\partial z_1} \left( \frac{(p_1 - p_2)^+}{\nu} \right) dz d\sigma. \end{aligned}$$

The first integral can be rewritten as

$$J_2^1 = \int_{Q_{z, \sigma}} \left( h(z + \sigma) - h(z - \sigma) \right) \frac{\partial}{\partial z_1} \left( \min \left[ \frac{(p_1 - p_2)^+}{\nu}, \phi \right] \right) dz d\sigma.$$

Integrating by parts, letting  $\nu \rightarrow 0$ , and using Lebesgue theorem, we get:

$$\lim_{\nu \rightarrow 0} J_2^1 = \int_{Q_{z, \sigma}} \left[ \frac{\partial h}{\partial z_1}(z + \sigma) - \frac{\partial h}{\partial z_1}(z - \sigma) \right] \chi_{[p_1 > p_2]} \xi(z_2) \rho_\varepsilon(\sigma_2) \hat{\rho}_{\varepsilon'}(\sigma_1).$$

Since  $\text{Supp}(\rho_\varepsilon) \subset [-\varepsilon, \varepsilon]$ ,  $\text{Supp}(\hat{\rho}_{\varepsilon'}) \subset [-\varepsilon', \varepsilon']$  and  $\frac{\partial h}{\partial z_1}$  is a Lipschitz continuous function,

we get:  $\left| \lim_{\nu \rightarrow 0} J_2^1 \right| \leq C(\varepsilon + \varepsilon') \int_{Q_{z, \sigma}} \xi(z_2) \rho_\varepsilon(\sigma_2) \hat{\rho}_{\varepsilon'}(\sigma_1)$ , and finally

$$\lim_{\varepsilon, \varepsilon' \rightarrow 0} \left| \lim_{\nu \rightarrow 0} J_2^1 \right| = 0.$$

The second integral can be rewritten in the old variables as

$$\begin{aligned} J_2^2 &= \int_Q h(X') (1 - \theta_2) \left[ \frac{\partial}{\partial x_1} \left( \frac{p_1 - p_2}{\nu} \right) + \frac{\partial}{\partial x'_1} \left( \frac{p_1 - p_2}{\nu} \right) \right] dz d\sigma \\ &= \int_Q h(X') (1 - \theta_2) \frac{\partial}{\partial x_1} \left( \frac{p_1}{\nu} \right) dz d\sigma \end{aligned}$$

since  $1 - \theta_2 = 0$  when  $p_2 > 0$ . Rewriting the integral, one gets:

$$\begin{aligned} J_2^2 &= \int_Q h(X') (1 - \theta_2) \frac{\partial}{\partial x_1} \min \left[ \frac{p_1}{\nu}, \phi \right] - \int_{A_\nu} h(X') (1 - \theta_2) \frac{\partial}{\partial x_1} (\phi) \\ &= \int_{B_\nu} h(X') (1 - \theta_2) \frac{\partial}{\partial x_1} (\phi), \end{aligned}$$

using the Green formula with periodicity and boundary conditions. Since the function

$$h(X') \left(1 - \theta_2(X')\right) \frac{\partial}{\partial x_1} \phi(X, X')$$

is bounded for each  $\varepsilon, \varepsilon'$ , we conclude

$$\left| \lim_{\nu \rightarrow 0} J_2^2 \right| \leq \lim_{\nu \rightarrow 0} C |B_\nu| = 0,$$

and finally,

$$\lim_{\varepsilon, \varepsilon' \rightarrow 0} \left| \lim_{\nu \rightarrow 0} J_2^2 \right| = 0.$$

• Let us study  $I_1$ :

$$I_1 = \int_{A_\nu} \left[ h^3(z + \sigma) \nabla_z p_1 - h^3(z - \sigma) \nabla_z p_2 \right] \nabla_z \left( \xi(z_2) \rho_\varepsilon(\sigma_2) \hat{\rho}_{\varepsilon'}(\sigma_1) \right).$$

By Lebesgue theorem,

$$\begin{aligned} \lim_{\nu \rightarrow 0} I_1 &= \int_{Q_{z,t}} \left[ h^3(z + \sigma) \frac{\partial p_1}{\partial z_2} - h^3(z - \sigma) \frac{\partial p_2}{\partial z_2} \right] \chi_{[p_1 > p_2]} \xi'(z_2) \rho_\varepsilon(\sigma_2) \hat{\rho}_{\varepsilon'}(\sigma_1) \\ &= \int_{Q_{z,t}} \left[ h^3(z + \sigma) - h^3(z - \sigma) \right] \frac{\partial p_2}{\partial z_2} \chi_{[p_1 > p_2]} \xi'(z_2) \rho_\varepsilon(\sigma_2) \hat{\rho}_{\varepsilon'}(\sigma_1) \\ &\quad + \int_{Q_{z,t}} h^3(z + \sigma) \frac{\partial p_1 - p_2}{\partial z_2} \chi_{[p_1 > p_2]} \xi'(z_2) \rho_\varepsilon(\sigma_2) \hat{\rho}_{\varepsilon'}(\sigma_1). \end{aligned}$$

Using the properties of  $\rho_\varepsilon, \hat{\rho}_{\varepsilon'}$  and since  $h^3$  is a Lipschitz continuous function, it is easy to conclude that the first integral goes to 0 when  $\varepsilon, \varepsilon' \rightarrow 0$ . Then we obtain, studying the behaviour of the second integral (see [4] for the details):

$$\lim_{\nu, \varepsilon, \varepsilon' \rightarrow 0} I_1 = \int_{\Omega} h^3(x) \frac{\partial}{\partial x_2} (p_1 - p_2)^+ \xi'(x_2) dx.$$

• Let us study  $I_2$ :

Rewriting  $I_2$  in the old variables gives:

$$\begin{aligned} I_2 &= \int_{B_\nu} \left[ h^3(X) \left| \nabla_1 \frac{p_1}{\nu} \right|^2 + h^3(X') \left| \nabla_2 \frac{p_2}{\nu} \right|^2 \right] \\ &\quad - \int_{B_\nu} h^3(X) \nabla_1 p_1 \nabla_2 \left( \frac{p_2}{\nu} \right) - \int_{B_\nu} h^3(X') \nabla_2 p_2 \nabla_1 \left( \frac{p_1}{\nu} \right). \end{aligned}$$

The first integral is positive. The second integral satisfies:

$$\begin{aligned} &\int_{B_\nu} h^3(X) \nabla_1 p_1 \nabla_2 \left( \frac{p_2}{\nu} \right) \\ &= - \int_{B_\nu} h^3(X) \nabla_1 p_1 \nabla_2 \left( \frac{p_1 - p_2}{\nu} \right) \\ &= - \int_Q h^3(X) \nabla_1 p_1 \nabla_2 (\eta_\nu) + \int_{B_\nu} h^3(X) \nabla_1 p_1 \nabla_2 (\phi) \\ &= - \int_Q h^3(X) \nabla_1 p_1 \nabla_2 (\eta_\nu) + \int_Q h^3(X) \nabla_1 p_1 \nabla_2 (\phi) - \int_{B_\nu} h^3(X) \nabla_1 p_1 \nabla_2 (\phi) \\ &= - \int_{B_\nu} h^3(X) \nabla_1 p_1 \nabla_2 (\phi). \end{aligned}$$

By Hölder inequality and since  $\lim_{\nu \rightarrow 0} |B_\nu| = 0$ , one gets:

$$\lim_{\nu \rightarrow 0} \int_{B_\nu} h^3(X) \nabla_1 p_1 \nabla_2 \left( \frac{p_2}{\nu} \right) \leq \lim_{\nu \rightarrow 0} |B_\nu|^{1/2} \left[ \int_Q h^6(X) |\nabla_1 p_1|^2 |\nabla_2 \phi|^2 \right]^{1/2} = 0.$$

In a similar way,

$$\lim_{\nu \rightarrow 0} \int_{B_\nu} h^3(X') \nabla_2 p_2 \nabla_1 \left( \frac{p_1}{\nu} \right) \leq \lim_{\nu \rightarrow 0} |B_\nu|^{1/2} \left[ \int_Q h^6(X') |\nabla_2 p_2|^2 |\nabla_1 \phi|^2 \right]^{1/2} = 0,$$

and we deduce

$$\lim_{\nu, \varepsilon, \varepsilon' \rightarrow 0} I_2 \geq 0.$$

Now passing to the limit  $(\nu, \varepsilon, \varepsilon' \rightarrow 0)$  in the integral equality concludes the proof.  $\square$

**Theorem 1.7** *Let  $(p_1, \theta_1)$  and  $(p_2, \theta_2)$  two solutions of  $(\mathcal{P}_\theta)$  with respective pressure boundary values  $p_a^1$  and  $p_a^2$  on  $\Gamma_a$ . Let us suppose that  $p_a^1 \leq p_a^2$ . Then*

$$p_1 \leq p_2, \quad \text{a.e. in } \Omega.$$

*Proof.* From Lemma 1.6, denoting  $f = (p_1 - p_2)^+$ , we have, for every  $\xi \in \mathcal{D}^+(0, 1)$ ,

$$\int_{\Omega} h^3(x) \frac{\partial f}{\partial x_2} \xi'(x_2) dx \leq 0.$$

Then one gets:

$$\int_{\Omega} f h^3 \xi''(x_2) dx + \int_{\Omega} f \frac{\partial h^3}{\partial x_2} \xi'(x_2) dx \geq 0, \quad \forall \xi \in \mathcal{D}^+(0, 1).$$

Using the following notations:

$$a(x_2) = \int_0^{2\pi} f(x_1, x_2) h^3(x_1, x_2) dx_1, \quad b(x_2) = \int_0^{2\pi} f(x_1, x_2) \frac{\partial h^3}{\partial y}(x_1, x_2) dx_1,$$

we get:

$$\int_0^1 a(x_2) \xi''(x_2) dx_2 + \int_0^1 b(x_2) \xi'(x_2) dx_2 \geq 0, \quad \forall \xi \in \mathcal{D}^+(0, 1). \quad (4)$$

Now let us suppose that  $a(x_2) > 0, \forall x_2 \in (y_0, y_1) \subset (0, 1)$  and let  $\xi_0$  be a solution of the two points boundary problem:

$$a(x_2) \xi''(x_2) + b(x_2) \xi'(x_2) = a(x_2) \psi'', \quad \xi(y_0) = \xi(y_1) = 0, \quad (5)$$

where  $\psi \in C^\infty[y_0, y_1]$  satisfying  $\psi''(x_2) < 0, \forall x_2 \in [y_0, y_1]$ . From the minimum principle,  $\xi_0(x_2) \geq 0, \forall x_2 \in [y_0, y_1]$ . Then we define a regularizing function  $g$  on  $[y_0, y_1]$  such that  $g\xi_0$  is a test function for Equation (4) and  $g(x_2) = 1$  on  $[y_0 + \delta, y_1 - \delta]$ . More precisely, let  $\delta$  be a positive parameter and  $g$  the function defined on  $[y_0, y_1]$  by

$$g(x_2) = \begin{cases} 2 \left( \frac{x_2 - y_0}{\delta} \right)^2, & x_2 \in (y_0, y_0 + \delta/2) \\ 1 - 2 \left( 1 - \frac{x_2 - y_0}{\delta} \right)^2, & x_2 \in (y_0 + \delta/2, y_0 + \delta) \\ 1, & x_2 \in (y_0 + \delta, y_1 - \delta) \\ 1 - 2 \left( 1 - \frac{y_1 - x_2}{\delta} \right)^2, & x_2 \in (y_1 - \delta, y_1 - \delta/2) \\ 2 \left( \frac{y_1 - x_2}{\delta} \right)^2, & x_2 \in (y_1 - \delta/2, y_1) \end{cases}$$

This function satisfies  $g(y_0) = g(y_1) = 0$  and  $g'(y_0) = g'(y_1) = 0$ . Let be  $\tilde{\xi}(x_2) = g(x_2)\xi_0(x_2)$ ,  $\forall x_2 \in [y_0, y_1]$ . We have  $\tilde{\xi} \in C^2(y_0, y_1)$ ,  $\tilde{\xi}(y_0) = \tilde{\xi}(y_1) = 0$  and  $\tilde{\xi}'(y_0) = \tilde{\xi}'(y_1) = 0$ . Therefore, we can take  $\xi = \tilde{\xi}$  in Equation (4) and get

$$\int_{y_0}^{y_1} a(x_2) \tilde{\xi}''(x_2) + b(x_2) \tilde{\xi}'(x_2) dx_2 \geq 0.$$

By separating the integration intervals, we decompose this integral in the form

$$\begin{aligned} \int_{y_0}^{y_0+\delta} a(x_2) (g\xi_0)'' + b(x_2) (g\xi_0)' dx_2 &+ \int_{y_0+\delta}^{y_1-\delta} a(x_2) \xi_0'' + b(x_2) \xi_0' dx_2 \\ &+ \int_{y_1-\delta}^{y_1} a(x_2) (g\xi_0)'' + b(x_2) (g\xi_0)' dx_2 \geq 0 \end{aligned} \quad (6)$$

From (5), the second integral is strictly negative, and for the two other integrals, we have

$$\begin{aligned} &\int_{y_0}^{y_0+\delta} a(x_2)(g\xi_0)'' + b(x_2)(g\xi_0)' dx_2 \\ &= \int_{y_0}^{y_0+\delta} a(x_2)(g''\xi_0 + 2g'\xi_0 + g\xi_0'') + b(x_2)(g'\xi_0 + g\xi_0') dx_2 \\ &= \int_{y_0}^{y_0+\delta} (a(x_2)g''\xi_0 + 2a(x_2)g'\xi_0 + a(x_2)g\xi_0'' + (b(x_2)g'\xi_0 + b(x_2)g\xi_0')) dx_2. \end{aligned} \quad (7)$$

Since  $|g'(x_2)| \approx 1/\delta$ ,  $|g''(x_2)| \approx 1/\delta^2$  and being the functions  $a$  and  $\xi_0$  continuous in the interval  $(y_0, y_0 + \delta)$ , the terms under the last integral in (7) are bounded and we obtain

$$\int_{y_0}^{y_0+\delta} a(x_2)(g\xi_0)'' + b(x_2)(g\xi_0)' dx_2 \approx \delta.$$

In the same way, we have

$$\int_{y_1-\delta}^{y_1} a(x_2)(g\xi_0)'' + b(x_2)(g\xi_0)' dx_2 \approx \delta.$$

Passing to the limit ( $\delta \rightarrow 0$ ) in inequality (6), one gets:

$$\int_{y_0}^{y_1} a \xi_0'' + b \xi_0' dx_2 \geq 0.$$

But we have also:

$$\int_{y_0}^{y_1} a \xi_0'' + b \xi_0' dx_2 = \int_{y_0}^{y_1} a \psi'' < 0.$$

Then we have:  $a(x_2) = \int_0^{2\pi} f h^3 dx_1 \leq 0$  on  $(0, 1)$ , that is  $\int_0^{2\pi} (p_1 - p_2)^+ h^3 dx_1 \leq 0$ , and we conclude  $p_1 \leq p_2$  a.e. in  $\Omega$ .  $\square$

**Theorem 1.8** *Under Assumptions 1.1 and 1.2, problem  $(\mathcal{P}_\theta)$  admits at least one solution  $(p, \theta)$  whose pressure  $p$  is unique. Moreover, if there exists a set of positive measure where  $p(x_1, x_2) > 0$ , for any  $x_2 > 0$ , then the saturation  $\theta$  is unique.*

*Proof.*

■ Uniqueness of the pressure is obtained from Theorem 1.7.

■ Let us consider  $(p, \theta_1)$  and  $(p, \theta_2)$  two solutions. Then we get, by means of subtraction:

$$\int_{\Omega} h (\theta_1 - \theta_2) \frac{\partial \psi}{\partial x_1} = 0, \quad \forall \psi \in V, \quad \text{and} \quad \frac{\partial h (\theta_1 - \theta_2)}{\partial x_1} = 0, \quad \text{in } \mathcal{D}'(\Omega),$$

so that  $h (\theta_1 - \theta_2)$  is a function only depending on the  $x_2$  variable, almost everywhere in  $\Omega$ . In particular, if there exists a set of positive measure where  $\theta_1(x) = \theta_2(x)$ , for every  $x_2 > 0$ , then  $\theta_1 = \theta_2$  a.e. in  $\Omega$ .  $\square$

We give a supplementary result :

**Corollary 1.9** *Under Assumptions 1.1 and 1.2 and if  $h$  can be written under the form  $h(x_1, x_2) = h_1(x_1)h_2(x_2)$  (with  $0 < h_0^i \leq h_i(x_i) \leq h_1^i$ ), then problem  $(\mathcal{P}_\theta)$  admits a unique solution.* ■

*Proof.* By Theorem 1.8, it is sufficient to prove that, for any  $x_2 > 0$ , there exists a set of positive measure, where  $p(x_1, x_2) > 0$ . Let be  $\psi$  a test function only depending on  $x_2$ . Then we have

$$\int_{\Omega} h^3 \frac{\partial p}{\partial x_2} \psi' = 0, \quad \text{i.e.} \quad \int_0^1 \left( \int_0^{2\pi} h^3(x_1, x_2) \frac{\partial p}{\partial x_2}(x_1, x_2) dx_1 \right) \psi'(x_2) dx_2 = 0.$$

Thus, we get

$$\int_0^{2\pi} h^3(x) \frac{\partial p}{\partial x_2}(x) dx_1 = C,$$

where  $C$  is a real constant. Since  $h$  can be written under the form  $h(x_1, x_2) = h_1(x_1)h_2(x_2)$ , dividing the previous equality by  $h_2^3(x_2)$  gives

$$\frac{\partial}{\partial x_2} \left( \int_0^{2\pi} h_1^3(x_1) p(x_1, x_2) dx_1 \right) = \frac{C}{h_2^3(x_2)}.$$

Integrating the previous equality and taking into account the boundary conditions on the pressure,

$$\left( \int_0^{2\pi} h_1^3(x_1) p(x_1, x_2) dx_1 \right) = \frac{\int_0^{2\pi} h_1^3}{\int_0^1 h_2^{-3}} p_a \int_0^{x_2} h_2^{-3}(t) dt > 0, \quad \forall x_2 > 0. \quad (8)$$

We deduce from Equation (8) that, for any  $x_2 > 0$ , there exists a set of positive measure, where  $p(x_1, x_2) > 0$ .  $\square$

The next sections deal with homogenization of the lubrication problem, using two-scale convergence techniques which have been introduced by Nguetseng in [34], and further developed by Allaire [1], Cioranescu, Damlamian and Griso [23] and Lukkassen, Nguetseng and Wall [31].

## 2 Homogenization of the lubrication problem

In the whole section,  $\Omega = ]0, 2\pi[ \times ]0, 1[$  and  $Y = ]0, 1[ \times ]0, 1[$ . Now we introduce the roughness of the upper surface; the roughness is supposed to be periodic, characterized by a small parameter  $\varepsilon$  denoting the roughness spacing. Due to the shape of the Reynolds equation, oscillating data appear in both sides of the equation. So we are led to consider the following problem  $(\mathcal{P}_\theta^\varepsilon)$  and assumptions:

**Assumption 2.1** *Let  $a$  and  $b$  be functions such that:*

- (i)  $a \in L^2_\#(\Omega; C_\#(Y))$  or  $a \in L^2_\#(Y; C_\#(\bar{\Omega}))$ ,
- (ii)  $b \in L^2_\#(\Omega; C_\#(Y))$  or  $b \in L^2_\#(Y; C_\#(\bar{\Omega}))$ ,
- (iii)  $\exists m_a, M_a, \quad \forall (x, y) \in \Omega \times Y, \quad 0 < m_a \leq a(x, y) \leq M_a$ ,
- (iv)  $\exists m_b, M_b, \quad \forall (x, y) \in \Omega \times Y, \quad 0 < m_b \leq b(x, y) \leq M_b$ .

We introduce the following functions defined on  $\Omega$ :

$$a_\varepsilon(x) = a\left(x, \frac{x}{\varepsilon}\right), \quad b_\varepsilon(x) = b\left(x, \frac{x}{\varepsilon}\right).$$

Then we introduce the following problem:

$$(\mathcal{P}_\theta^\varepsilon) \begin{cases} \text{Find } (p_\varepsilon, \theta_\varepsilon) \in V_a \times L^\infty(\Omega) \text{ such that:} \\ \int_\Omega a_\varepsilon \nabla p_\varepsilon \nabla \phi = \int_\Omega \theta_\varepsilon b_\varepsilon \frac{\partial \phi}{\partial x_1}, \quad \forall \phi \in V_0, \\ p_\varepsilon \geq 0, \quad p_\varepsilon (1 - \theta_\varepsilon) = 0, \quad 0 \leq \theta_\varepsilon \leq 1, \quad a.e. \text{ in } \Omega. \end{cases}$$

Existence and uniqueness results have been discussed in Section 1. Our purpose is to discuss the behaviour of problem  $(\mathcal{P}_\theta^\varepsilon)$  when  $\varepsilon$  goes to 0, using two-scale convergence techniques.

### 2.1 Preliminaries to the two-scale convergence technique

First we recall some useful definitions and results for the two-scale convergence (see [1, 23, 31]).

**Lemma 2.2** *The separable Banach space  $L^2(\Omega; C_\#(Y))$  is dense in  $L^2(\Omega \times Y)$ . Moreover, if  $f \in L^2(\Omega; C_\#(Y))$ , then  $x \mapsto \sigma_\varepsilon(f)(x) = f(x, x/\varepsilon)$  is a measurable function such that*

$$\left\| \sigma_\varepsilon(f) \right\|_{L^2(\Omega)} \leq \left\| f \right\|_{L^2(\Omega; C_\#(Y))}$$

**Definition 1** *The sequence  $u_\varepsilon \in L^2(\Omega)$  two-scale converges to a limit  $u_0 \in L^2(\Omega \times Y)$  if, for any  $\psi \in L^2(\Omega; C_\#(Y))$ , one has*

$$\lim_{\varepsilon \rightarrow 0} \int_\Omega u_\varepsilon(x) \psi\left(x, \frac{x}{\varepsilon}\right) dx = \int_\Omega \int_Y u_0(x, y) \psi(x, y) dy dx.$$

**Lemma 2.3** *Let  $u_\varepsilon$  be a bounded sequence in  $L^2(\Omega)$ . Then there exists  $u_0 \in L^2(\Omega \times Y)$  such that, up to a subsequence,  $u_\varepsilon$  two-scale converges to  $u_0$ .*

**Lemma 2.4** *Let  $u_\varepsilon$  be a bounded sequence in  $H^1(\Omega)$ , which weakly converges to a limit  $u_0 \in H^1(\Omega)$ . Then  $u_\varepsilon$  two-scale converges to  $u_0$  and there exists a function  $u_1 \in L^2(\Omega; H^1(Y)/\mathbb{R})$  such that, up to a subsequence,  $\nabla u_\varepsilon$  two-scale converges to  $\nabla u_0 + \nabla_y u_1$ .*



## 2.2 Two-scale convergence results

In this subsection,  $(p_\varepsilon, \theta_\varepsilon)$  denotes a solution of problem  $(\mathcal{P}_\theta^\varepsilon)$ .

**Lemma 2.5** *There exists  $p_0 \in V_a$  such that, up to a subsequence:*

$$p_\varepsilon \rightharpoonup p_0 \text{ in } H^1(\Omega) \quad \text{and} \quad p_\varepsilon \rightarrow p_0 \text{ in } L^2(\Omega).$$

*We have also the following two-scale convergences:*

(i)  $p_\varepsilon$  two-scale converges to  $p_0$ . Moreover, there exists  $p_1 \in L^2(\Omega; H_{\sharp}^1(Y)/\mathbb{R})$  and a subsequence  $\varepsilon'$ , still denoted  $\varepsilon$ , such that  $\nabla p_\varepsilon$  two-scale converges to  $\nabla p_0 + \nabla_y p_1$ .

(ii) There exists  $\theta_0 \in L^2(\Omega \times Y)$  and a subsequence  $\varepsilon''$ , still denoted  $\varepsilon$ , such that  $\theta_\varepsilon$  two-scale converges to  $\theta_0$ .

*Moreover,  $p_0 \geq 0$  a.e. in  $\Omega$ .*

*Proof.* Since  $0 \leq \theta_\varepsilon \leq 1$ ,  $\theta_\varepsilon$  is bounded in  $L^\infty(\Omega)$  and in  $L^2(\Omega)$ , so that  $\|\theta_\varepsilon\|_{L^2(\Omega)} \leq C_1$ , where  $C_1$  only depends on  $\Omega$ . Moreover, from Assumptions 2.1 (ii)–(iv), properties of  $\theta_\varepsilon$  and the Cauchy-Schwarz inequality, we get the estimates on  $p_\varepsilon$  by using  $p_\varepsilon - \bar{p}_a$  (with  $\bar{p}_a$  a regular function such that  $p_\varepsilon - \bar{p}_a \in V_0$ ) as a test function and Poincaré-Friedrichs inequality so that  $\|p_\varepsilon\|_{H^1(\Omega)} \leq C_2$  where  $C_2$  only depends on  $\Omega$ . The convergence results are the consequence of the previous estimates (see Lemmas 2.3 and 2.4, or Proposition 1.14 in [1], Theorem 13 in [31]). Finally  $p_0 \geq 0$  a.e. in  $\Omega$  due to the properties of  $p_\varepsilon$ .  $\square$

Now, we give the properties of the two-scale limits  $p_0$  and  $\theta_0$ , which are quite similar to the ones of the initial functions  $p_\varepsilon$  and  $\theta_\varepsilon$ . These properties are obtained by means of two-scale convergence techniques.

**Proposition 2.6**  $0 \leq \theta_0 \leq 1$  a.e. in  $\Omega \times Y$ .

*Proof.* Let us introduce the classical notation  $w^+ = \max(w, 0)$  and  $w^- = -\min(w, 0)$ , for any  $w \in L^2(\Omega \times Y)$ . Since  $L^2(\Omega; C_{\sharp}(Y))$  is dense in  $L^2(\Omega \times Y)$  (see Theorem 3 in [31]), let us consider a sequence  $\phi_n \in L^2(\Omega; C_{\sharp}(Y))$ ,  $\phi_n \geq 0$ , which strongly converges to  $\theta_0^-$  in

$L^2(\Omega \times Y)$  (note that such a sequence exists<sup>1</sup>). Thus, defining the following sequences

$$A_n^\varepsilon = \int_{\Omega} \theta_\varepsilon(x) \phi_n \left( x, \frac{x}{\varepsilon} \right) dx, \quad A_n^* = \int_{\Omega \times Y} \theta_0(x, y) \phi_n(x, y) dy dx,$$

we have, using the two-scale convergence of  $\theta_\varepsilon$ ,

$$\lim_{\varepsilon \rightarrow 0} A_n^\varepsilon = A_n^*.$$

Obviously,  $A_n^\varepsilon$  is a sequence of positive numbers so that we have also:  $A_n^* \geq 0$ . Now letting  $n \rightarrow +\infty$ , we have:

$$\lim_{n \rightarrow +\infty} A_n^* = - \int_{\Omega \times Y} (\theta_0^-)^2 = A \quad (\leq 0).$$

Thus,  $A_n^*$  being a sequence of positive numbers,  $A \geq 0$  so that, finally,  $A = 0$ . Thus, we have proved that  $\theta_0^- = 0$  a.e. Similarly, it can be proved that  $(1 - \theta_0)^- = 0$  a.e.  $\square$

**Proposition 2.7**  $p_0(1 - \theta_0) = 0$  a.e. in  $\Omega \times Y$ .

*Proof.* By uniqueness of the two-scale limit (see [1, 31]), it is sufficient to prove that  $p_\varepsilon(1 - \theta_\varepsilon)$  two-scale converges to  $p_0(1 - \theta_0)$ . As  $p_\varepsilon$  two-scale converges to  $p_0$ , let us prove that  $p_\varepsilon \theta_\varepsilon$  two-scale converges to  $p_0 \theta_0$ . The sequence  $\{\theta_\varepsilon p_\varepsilon\}$  is bounded in  $L^2(\Omega)$ . Consequently, it remains to prove (see Proposition 1 in [31]):

$$\int_{\Omega} p_\varepsilon(x) \theta_\varepsilon(x) \phi \left( x, \frac{x}{\varepsilon} \right) dx \rightarrow \int_{\Omega \times Y} p_0(x) \theta_0(x, y) \phi(x, y) dy dx,$$

for all  $\phi \in D(\Omega; C_{\sharp}^\infty(Y))$ . Let  $\phi$  be a function in  $D(\Omega; C_{\sharp}^\infty(Y))$  and let  $\alpha_\varepsilon$  be defined by:

$$\alpha_\varepsilon = \int_{\Omega} p_\varepsilon(x) \theta_\varepsilon(x) \phi \left( x, \frac{x}{\varepsilon} \right) dx - \int_{\Omega \times Y} p_0(x) \theta_0(x, y) \phi(x, y) dy dx.$$

Our purpose is to prove that  $\alpha_\varepsilon$  tends to 0. Then we have:

---

<sup>1</sup>Let  $\psi \in L^2(\Omega \times Y)$ ,  $\psi \geq 0$ . By Theorem 3 in [31], there exists a sequence  $\psi_n \in L^2(\Omega; C_{\sharp}(Y))$  such that  $\psi_n$  strongly converges to  $\psi$  in  $L^2(\Omega \times Y)$ . Now it is sufficient to prove that

- (i)  $\psi_n^+ \in L^2(\Omega; C_{\sharp}(Y))$ ,
- (ii)  $\psi_n^+$  strongly converges to  $\psi$  in  $L^2(\Omega \times Y)$  up to a subsequence.

We have the following characterization of  $L^2(\Omega; C_{\sharp}(Y))$  (see Theorem 1 of [31]): a function  $f$  belongs to  $L^2(\Omega \times Y)$  if and only if there exists a subset  $E$  of measure zero in  $\Omega$  such that:

- (a) for any  $x \in \Omega \setminus E$ , the function  $y \rightarrow f(x, y)$  is continuous and  $Y$  periodic,
- (b) for any  $y \in Y$ , the function  $x \rightarrow f(x, y)$  is measurable,
- (c) the function  $x \rightarrow \sup_{y \in Y} |f(x, y)|$  has finite  $L^2(\Omega)$  norm.

Thus, it is obvious that if  $\psi_n \in L^2(\Omega; C_{\sharp}(Y))$ , then  $\psi_n^+ \in L^2(\Omega; C_{\sharp}(Y))$ . It remains to prove that, up to a subsequence,  $\psi_n^-$  strongly converges to 0 in  $L^2(\Omega \times Y)$ . Thus, by Theorem IV.9 in [20], as  $\psi_n, \psi \in L^2(\Omega \times Y)$  with  $\|\psi_n - \psi\|_{L^2(\Omega \times Y)} \rightarrow 0$ , there exists a subsequence  $\psi_{n_k}$  such that

- (a)  $\psi_{n_k} \rightarrow \psi$  a.e. in  $\Omega \times Y$ ,
- (b)  $|\psi_{n_k}(x, y)| \leq \Lambda(x, y)$ , for all  $n_k$ , a.e. in  $\Omega \times Y$ , with  $\Lambda \in L^2(\Omega \times Y)$ .

Now, since  $\psi_{n_k}^- \rightarrow 0$  a.e. on  $\Omega \times Y$  and  $|\psi_{n_k}^-(x, y)| \leq |\psi_{n_k}(x, y)| \leq \Lambda(x, y)$  we state from the Lebesgue theorem that  $\|\psi_{n_k}^-\|_{L^2(\Omega \times Y)} \rightarrow 0$ , and the proof is concluded.

$$\begin{aligned} \alpha_\varepsilon &= \underbrace{\int_{\Omega} [p_\varepsilon(x) - p_0(x)] \theta_\varepsilon(x) \phi\left(x, \frac{x}{\varepsilon}\right) dx}_{\Lambda_\varepsilon^1} \\ &\quad + \underbrace{\int_{\Omega} p_0(x) \theta_\varepsilon(x) \phi\left(x, \frac{x}{\varepsilon}\right) dx - \int_{\Omega \times Y} p_0(x) \theta_0(x, y) \phi(x, y) dy dx}_{\Lambda_\varepsilon^2}. \end{aligned}$$

■ Using the Cauchy-Schwarz inequality and Lemma 2.2 (see also Lemma 1.3 in [1] or Theorem 3 in [31]), we have:

$$\left| \Lambda_\varepsilon^1 \right| \leq \left\| p_\varepsilon - p_0 \right\|_{L^2(\Omega)} \left\| \sigma_\varepsilon(\phi) \right\|_{L^2(\Omega)} \leq \left\| p_\varepsilon - p_0 \right\|_{L^2(\Omega)} \left\| \phi \right\|_{L^2(\Omega; C_{\sharp}^1(Y))}.$$

As  $p_\varepsilon \rightarrow p_0$  in  $L^2(\Omega)$ , we have:  $\left| \Lambda_\varepsilon^1 \right| \rightarrow 0$ .

■ In order to prove that  $\Lambda_\varepsilon^2 \rightarrow 0$ , since  $\theta_\varepsilon$  two-scale converges to  $\theta_0$ , it is sufficient to prove that  $(x, y) \rightarrow \psi(x, y) = p_0(x) \phi(x, y)$  is an admissible test function for the two-scale convergence (i.e.  $\psi \in L^2(\Omega; C_{\sharp}^1(Y))$ ).

Let us prove that  $(x, y) \rightarrow p_0(x) \phi(x, y) \in L^2(\Omega; C_{\sharp}^1(Y))$  for every  $\phi \in D(\Omega; C_{\sharp}^\infty(Y))$ .

▷ With  $\phi \in D(\Omega; C_{\sharp}^\infty(Y))$  and  $p_0 \in H^1(\Omega)$ , we have for a.e.  $x$  in  $\Omega$ :

$$p_0(x) \phi(x, \cdot) \in C_{\sharp}^\infty(Y) \subset C_{\sharp}^1(Y).$$

▷ Let us denote  $\Psi_0(x, y) = p_0(x) \phi(x, y)$ . As  $p_0 \in H^1(\Omega) \subset L^4(\Omega)$ ,  $\phi \in D(\Omega; C_{\sharp}^\infty(Y)) \subset L^4(\Omega; C_{\sharp}^1(Y))$ , by the Cauchy-Schwarz inequality,

$$\begin{aligned} \left\| \Psi_0 \right\|_{L^2(\Omega; C_{\sharp}^1(Y))}^2 &= \int_{\Omega} p_0^2(x) \sup_{y \in Y} \left| \phi(x, y) \right|^2 dx \\ &\leq \left( \int_{\Omega} p_0^4(x) dx \right)^{1/2} \left( \int_{\Omega} \sup_{y \in Y} \left| \phi(x, y) \right|^4 dx \right)^{1/2} < +\infty. \end{aligned}$$

We have proved that  $(x, y) \rightarrow p_0(x) \phi(x, y) \in L^2(\Omega; C_{\sharp}^1(Y))$  for any function  $\phi \in D(\Omega; C_{\sharp}^\infty(Y))$ . Then,  $\Lambda_\varepsilon^2 \rightarrow 0$ . □

### 2.3 Homogenization of the lubrication problem (general case)

Using an idea developed in [1], one has the following macro-microscopic decomposition:

**Theorem 2.8** *From the initial formulation,*

■ *Macroscopic equation:*

$$\int_{\Omega} \left( \int_Y a \left[ \nabla p_0 + \nabla_y p_1 \right] dy \right) \nabla \phi dx = \int_{\Omega} \left( \int_Y \theta_0 b dy \right) \frac{\partial \phi}{\partial x_1} dx, \quad (9)$$

for every  $\phi$  in  $V_0$ .

■ **Microscopic equation:**

For a.e.  $x \in \Omega$ ,

$$\int_Y a \left[ \nabla p_0 + \nabla_y p_1 \right] \nabla_y \psi \, dy = \int_Y \theta_0 b \frac{\partial \psi}{\partial y_1} \, dy, \quad (10)$$

for every  $\psi \in H_{\sharp}^1(Y)$ .

*Proof.* Using the test function

$$\phi(x) + \varepsilon \phi_1(x) \psi \left( \frac{x}{\varepsilon} \right)$$

with  $\phi \in V_0$ ,  $\phi_1 \in \mathcal{D}(\Omega)$  and  $\psi \in H_{\sharp}^1(Y)$  in problem  $(\mathcal{P}_{\theta}^{\varepsilon})$ , one has:

$$\begin{aligned} \int_{\Omega} a \left( x, \frac{x}{\varepsilon} \right) \nabla p_{\varepsilon}(x) \left[ \nabla \phi(x) + \phi_1(x) \nabla_y \psi \left( \frac{x}{\varepsilon} \right) + \varepsilon \psi \left( \frac{x}{\varepsilon} \right) \nabla_x \phi_1(x) \right] dx \\ = \int_{\Omega} \theta_{\varepsilon}(x) b \left( x, \frac{x}{\varepsilon} \right) \left[ \frac{\partial \phi}{\partial x_1}(x) + \phi_1(x) \frac{\partial \psi}{\partial y_1} \left( \frac{x}{\varepsilon} \right) + \varepsilon \psi \left( \frac{x}{\varepsilon} \right) \frac{\partial \phi_1}{\partial x_1}(x) \right] dx. \end{aligned}$$

Passing to the limit ( $\varepsilon \rightarrow 0$ ) gives us the macroscopic equation (with  $\phi_1 \equiv 0$ ) and the microscopic equation (with  $\phi \equiv 0$ ), using density results.  $\square$

Let us define the local problems, respectively denoted  $(\mathcal{M}_i^*)$ ,  $(\mathcal{N}_i^*)$  and  $(\mathcal{N}_i^0)$ :

Find  $W_i^*$ ,  $\chi_i^*$ ,  $\chi_i^0$  ( $i = 1, 2$ ) in  $L^2(\Omega; H_{\sharp}^1(Y)/\mathbb{R})$ , such that, for almost every  $x \in \Omega$ :

$$\int_Y a \nabla_y W_i^* \nabla_y \psi = \int_Y a \frac{\partial \psi}{\partial y_i}, \quad \forall \psi \in H_{\sharp}^1(Y) \quad (i = 1, 2) \quad (11)$$

$$\int_Y a \nabla_y \chi_i^* \nabla_y \psi = \int_Y b \frac{\partial \psi}{\partial y_i}, \quad \forall \psi \in H_{\sharp}^1(Y) \quad (i = 1, 2) \quad (12)$$

$$\int_Y a \nabla_y \chi_i^0 \nabla_y \psi = \int_Y \theta_0 b \frac{\partial \psi}{\partial y_i}, \quad \forall \psi \in H_{\sharp}^1(Y) \quad (i = 1, 2) \quad (13)$$

We immediatly have:

**Lemma 2.9** *Problem  $(\mathcal{M}_i^*)$  (resp.  $(\mathcal{N}_i^*), (\mathcal{N}_i^0)$ ) admits a unique solution  $W_i^*$  (resp.  $\chi_i^*, \chi_i^0$ ) in  $L^2(\Omega; H_{\sharp}^1(Y)/\mathbb{R})$ .*

**Theorem 2.10** *The homogenized problem can be written as*

$$(\mathcal{P}_{\theta}^*) \begin{cases} \text{Find } (p_0, \Xi_1, \Xi_2) \in V_a \times L^{\infty}(\Omega) \times L^{\infty}(\Omega) \text{ such that} \\ \int_{\Omega} \mathcal{A} \cdot \nabla p_0 \nabla \phi = \int_{\Omega} \underline{b}^0 \nabla \phi, \quad \forall \phi \in V_0, \\ p_0 \geq 0 \quad \text{and} \quad p_0 (1 - \Xi_i) = 0, \quad (i = 1, 2) \quad \text{a.e. in } \Omega, \end{cases}$$

with  $\mathcal{A} = \begin{pmatrix} a_{11}^* & a_{12}^* \\ a_{21}^* & a_{22}^* \end{pmatrix}$ ,  $\underline{b}^0 = \begin{pmatrix} \Xi_1 b_1^* \\ \Xi_2 b_2^* \end{pmatrix}$  and  $\tilde{f}(x) = \int_Y f(x, y) \, dy$ , being the homogenized coefficients defined as

$$a_{ij}^* = \tilde{a} \delta_{ij} - \left[ a \frac{\partial W_j^*}{\partial y_i} \right], \quad b_i^* = \tilde{b} - \left[ a \frac{\partial \chi_i^*}{\partial y_i} \right].$$

Moreover, the homogenized problem admits at least a solution.

*Proof.* From Lemma 2.9, one has:

$$p_1(x, y) = -W^*(x, y) \cdot \nabla p_0(x) + \chi_1^0(x, y), \quad \text{in } L^2(\Omega; H_{\sharp}^1(Y)/\mathbb{R}) \quad (14)$$

with  $W^* = \begin{pmatrix} W_1^* \\ W_2^* \end{pmatrix}$ . Let us notice that  $\chi_1^0(x, y)$  depends on  $\theta_0(x, y)$  which is unknown. Using Equation (14) in the macroscopic equation gives:

$$\begin{aligned} \int_{\Omega} \left[ \tilde{a} I - \widetilde{a \nabla W^*} \right] \cdot \nabla p_0 \nabla \phi &= \int_{\Omega} \left[ \widetilde{(\theta_0 b)} - \left( a \frac{\partial \chi_1^0}{\partial y_1} \right) \right] \frac{\partial \phi}{\partial x_1} \\ &+ \int_{\Omega} \left[ - \left( a \frac{\partial \chi_1^0}{\partial y_2} \right) \right] \frac{\partial \phi}{\partial x_2}, \end{aligned} \quad (15)$$

for every  $\phi \in V_0$ . Introducing the notations  $\underline{b}_i^0 = \widetilde{(\theta_0 b)} - \left( a \frac{\partial \chi_1^0}{\partial y_i} \right)$  ( $i = 1, 2$ ), one gets

$$\int_{\Omega} \mathcal{A} \cdot \nabla p_0 \nabla \phi = \int_{\Omega} \underline{b}^0 \nabla \phi, \quad \forall \phi \in V_0,$$

with

$$\mathcal{A} = \tilde{a} I - \widetilde{a \nabla W^*} \quad \underline{b}^0 = \begin{pmatrix} b_1^0 \\ b_2^0 \end{pmatrix}.$$

Introducing the ratios  $\Xi_i = b_i^0/b_i^*$  in the vector  $\underline{b}^0$  concludes the proof.  $\square$

**Remark 2.11** *The homogenized lubrication problem can be considered as a generalized Reynolds-type problem with two saturation functions  $\Xi_i$  ( $i = 1, 2$ ). Let us notice that if there is no cavitation phenomena (i.e.  $p_0 > 0$ ) then  $\Xi_i = 1$ : thus, we get the classical homogenized Reynolds equation (without cavitation) (see [13]). But several aspects remain hard to describe:*

- (a) *The homogenized problem leads us to consider two different saturation functions, since an extra term has to be added (in the  $x_2$  direction of the flow) when comparing the homogenized problem to the initial problem.*
- (b) *Another point is to consider the fact that the property  $0 \leq \Xi_i \leq 1$  is missing, i.e. we cannot guarantee that homogenized cavitation parameters are smaller than 1 in cavitation areas !*
- (c) *We are not able to prove any uniqueness result, for the homogenized problem, using the methods described in Section 1.*
- (d) *Algorithms are known to solve the roughness problem (see for instance the papers by Alt [3], Bayada, Chambat and Vazquez [15], Marini and Pietra [32]). But how to solve the homogenized problem numerically? How to treat the two different saturation functions?*

*Thus these four difficulties have to be underlined in the most general case and, in the following subsections, we show how it is possible to solve them, fully or at least partially. Additional assumptions have to be made in order to get an homogenized problem with a structure which is similar to the initial one. This will be the subject of the following subsection. Before starting this study, let us conclude this subsection with the following theorem:*

**Theorem 2.12** *The homogenized problem  $(\mathcal{P}_\theta^*)$  admits a solution  $(p_0, \Xi, \Xi)$  with  $0 \leq \Xi \leq 1$  a.e. in  $\Omega$ .*

*Proof.* The result is obtained in three steps: first, we consider the penalized rough problem  $(\mathcal{P}_\eta^\varepsilon)$ ; then, we apply the homogenization process to the penalized problem (i.e.  $\varepsilon \rightarrow 0$ ); finally, we pass to the limit on the penalization parameter (i.e.  $\eta \rightarrow 0$ ).

■ *1st step* - Let us consider the rough penalized problem:

$$(\mathcal{P}_\eta^\varepsilon) \begin{cases} \text{Find } p_\varepsilon^\eta \in V_a \text{ such that:} \\ \int_\Omega a_\varepsilon \nabla p_\varepsilon^\eta \nabla \phi = \int_\Omega H_\eta(p_\varepsilon^\eta) b_\varepsilon \frac{\partial \phi}{\partial x_1}, \quad \forall \phi \in V_0. \\ p_\varepsilon^\eta \geq 0, \quad \text{a.e. in } \Omega \end{cases}$$

■ *2nd step* - Similarly to the exact rough problem, we get a priori estimates on the pressure, i.e.  $\|p_\varepsilon^\eta\|_{H^1(\Omega)} \leq C_3$  where  $C_3$  only depends on  $\Omega$ . From the previous estimate, we deduce that there exists  $p_0^\eta \in V_a$  ( $p_0^\eta \geq 0$  a.e. in  $\Omega$ ) such that, up to a subsequence,  $p_\varepsilon^\eta$  weakly converges to  $p_0^\eta$  in  $H^1(\Omega)$ . Moreover,  $p_\varepsilon^\eta$  two-scale converges to  $p_0^\eta$  and there exists  $p_1^\eta \in L^2(\Omega; H_\sharp^1(Y)/\mathbb{R})$  and a subsequence  $\varepsilon'$  still denoted  $\varepsilon$  such that  $\nabla p_\varepsilon^\eta$  two-scale converges to  $\nabla p_0^\eta + \nabla_y p_1^\eta$ . Then, with the two-scale homogenization technique, we get the following macro/microscopic decomposition:

• **Macroscopic equation:**

$$\int_\Omega \left( \int_Y a \left[ \nabla p_0^\eta + \nabla_y p_1^\eta \right] dy \right) \nabla \phi dx = \int_\Omega \left( \int_Y H_\eta(p_0^\eta) b dy \right) \frac{\partial \phi}{\partial x_1} dx, \quad (16)$$

for every  $\phi$  in  $V_0$ .

• **Microscopic equation:**

For a.e.  $x \in \Omega$ ,

$$\int_Y a \left[ \nabla p_0^\eta + \nabla_y p_1^\eta \right] \nabla_y \psi dy = \int_Y H_\eta(p_0^\eta) b \frac{\partial \psi}{\partial x_1} dy, \quad (17)$$

for every  $\psi \in H_\sharp^1(Y)$ .

Then introducing the local problems defined in Equations (11) and (12), we get:

$$p_1^\eta(x, y) = -W^*(x, y) \cdot \nabla p_0^\eta(x) + H_\eta(p_0^\eta(x)) \chi_1^*(x, y), \quad \text{in } L^2(\Omega; H_\sharp^1(Y)/\mathbb{R}). \quad (18)$$

Using Equation (18) in the macroscopic equation gives:

$$\begin{aligned} \int_\Omega \left[ \tilde{a}I - \widetilde{a \nabla W^*} \right] \nabla p_0^\eta \nabla \phi &= \int_\Omega H_\eta(p_0^\eta) \left[ \tilde{b} - \left( a \frac{\partial \chi_1^*}{\partial y_1} \right) \right] \frac{\partial \phi}{\partial x_1} \\ &+ \int_\Omega H_\eta(p_0^\eta) \left[ - \left( a \frac{\partial \chi_1^*}{\partial y_2} \right) \right] \frac{\partial \phi}{\partial x_2}, \end{aligned} \quad (19)$$

for every  $\phi \in V_0$ . Then, using the definitions of  $b_i^*$  ( $i = 1, 2$ ) (see Theorem 2.10) and introducing vector  $\underline{b}^*$  whose  $i$ th component is  $b_i^*$ , the homogenized penalized problem can be written as

$$(\mathcal{P}_\eta^*) \begin{cases} \text{Find } p_0^\eta \in V_a \text{ such that} \\ \int_\Omega \mathcal{A} \cdot \nabla p_0^\eta \nabla \phi = \int_\Omega H_\eta(p_0^\eta) \underline{b}^* \nabla \phi, \quad \forall \phi \in V_0, \\ p_0^\eta \geq 0, \quad \text{a.e. in } \Omega. \end{cases}$$

■ *3rd step* - As  $\mathcal{A}$  is a coercive matrix (see [18]), we establish a priori estimates on  $p_0^\eta$ , in the  $H^1(\Omega)$  norm, which do not depend on  $\eta$ , so that there exists  $p_0 \in V_a$ , ( $p_0 \geq 0$  a.e. in  $\Omega$ ) and  $\Xi \in L^\infty(\Omega)$  such that

$$\begin{aligned} p_0^\eta &\rightharpoonup p_0, & \text{in } H^1(\Omega), \\ H_\eta(p_0^\eta) &\rightharpoonup \Xi, & \text{in } L^\infty(\Omega) \text{ weak-}\star. \end{aligned}$$

Passing to the limit ( $\eta \rightarrow 0$ ) in problem  $(\mathcal{P}_\eta^*)$  concludes the proof, since the properties  $0 \leq \Xi \leq 1$  and  $p_0(1 - \Xi) = 0$  a.e. in  $\Omega$  are classically obtained as in Section 1.  $\square$

**Remark 2.13** *Let us recall that we are not able to prove a uniqueness result on the general problem. But we can wonder if it is possible to obtain a uniqueness result among the class of solutions  $(p_0, \Xi_1, \Xi_2)$  satisfying  $\Xi_1 = \Xi_2 = \Xi$  with  $0 \leq \Xi \leq 1$  (and, of course,  $p_0 \geq 0$ ,  $p_0(1 - \Xi) = 0$ ). In fact, it is not possible to get such a result using the method described in Section 1, because it is not well-suited to a flow whose component in the  $x_2$  direction is different from 0.*

**Remark 2.14** *Theorem 2.12 guarantees that we are able to build an homogenized problem with isotropic saturation from the penalized problem, although it is not the case when directly studying the homogenization of the exact problem (in the most general case):*

- *the penalized problem allows us to build a solution in pressure/saturation  $(p_0, \Xi, \Xi)$  where the saturation  $\Xi$  satisfies  $0 \leq \Xi \leq 1$  (and, also,  $p_0 \geq 0$  and  $p_0(1 - \Xi) = 0$ );*
- *by contrast, the exact problem with the homogenization process builds a solution in pressure / double-saturation  $(p_0, \Xi_1, \Xi_2)$  for which we are not able to conclude that  $0 \leq \Xi_i \leq 1$  (although the following properties hold:  $p_0 \geq 0$  and  $p_0(1 - \Xi_i) = 0$ , ( $i = 1, 2$ )).*

*At that point, it is important to know whether  $\theta_0(x, y)$  depends on  $y$  or not: that  $\theta_0$  does not depend on the  $y$  variable would mean that the homogenized exact problem and the homogenized penalized problem (after passing to the limit on  $\eta$ ) are identical, i.e. saturation phenomena would be isotropic. More precisely, in the exact homogenized problem, such an assumption leads us to  $\Xi_1 = \Xi_2 = \theta_0$  (see Equations (13) and (19)),  $0 \leq \Xi_i = \theta_0 \leq 1$  (see Propositions 2.6 and 2.7). But, in fact, numerical tests evidence that such an assumption is not valid in general, as it will be pointed out in the next section.*

**Remark 2.15** *It is now possible to find, numerically, a solution of problem  $(\mathcal{P}_\theta^*)$ , by focusing on solutions  $(p_0, \Xi, \Xi)$  satisfying  $0 \leq \Xi \leq 1$  (with  $p_0 \geq 0$  and  $p_0(1 - \Xi) = 0$ ), and using algorithms that have been previously mentioned. In that prospect, it allows us to eliminate another difficulty that has been underlined in Remark 2.11. But, since we do not have any uniqueness result, we cannot guarantee that each solution  $(p, \Xi_1, \Xi_2)$  satisfies  $\Xi_1 = \Xi_2$  and we are not able to build numerically solutions with two different saturation functions. We can neither illustrate numerically anisotropic effects on the saturation, nor prove that all the solutions have the form  $(p_0, \Xi, \Xi)$ .*

## 2.4 Some particular cases

### 2.4.1 Longitudinal and transverse roughness

Our interest in studying the behaviour of the solution when considering transverse or longitudinal roughness is highly motivated by the mechanical applications. From a mathematical point of view, we may even consider a product of transverse and longitudinal roughness i.e. we should consider, in this subsection, the following assumption:

#### Assumption 2.16

- (i)  $a(x, y) = a_1(x, y_1) a_2(x, y_2)$ ,
- (ii)  $\exists m_{a,i}, M_{a,i}, \quad 0 < m_{a,i} \leq a_i \leq M_{a,i}, (i = 1, 2)$ ,
- (iii)  $b(x, y) = b_1(x, y_1) b_2(x, y_2)$ ,
- (iv)  $\exists m_{b,i}, M_{b,i}, \quad 0 < m_{b,i} \leq b_i \leq M_{b,i}, (i = 1, 2)$ .

It is clear that the earlier assumption is just a separation of the microscale variables, which allows us to take into account either transverse or longitudinal roughness effects, but also particular full two dimensional roughness effects. For a dimensionless journal bearing, we may consider gaps with roughness patterns described on FIG.2–5, corresponding to a roughless gap  $1 + \rho \cos(x_1), x \in ]0, 2\pi[ \times ]0, 1[$ .

**Lemma 2.17** *Under Assumption 2.16, it follows that:*

$$\mathcal{A} = \begin{pmatrix} \overline{\tilde{a}_2} & 0 \\ a_1^{-1} & \overline{\tilde{a}_1} \\ 0 & \overline{\tilde{a}_1} \\ & a_2^{-1} \end{pmatrix}.$$

*Proof.*

■ *Diagonal terms of the matrix.* For this, let us recall the variational formulation (see Equation (11)) of problem  $(\mathcal{M}_i^*) (i = 1, 2)$ :

$$\int_Y a \nabla_y W_i^* \nabla_y \psi = \int_Y a \frac{\partial \psi}{\partial y_i}, \quad \forall \psi \in H_{\sharp}^1(Y).$$

Let  $j \in \{1, 2\}$ , with  $j \neq i$ . Denoting  $[f]_{Y_j}$  the averaging process of a function  $f$  on the  $y_j$  variable and using a test function only depending on  $y_i$ , one has:

$$\int_{Y_i} \left[ a \frac{\partial W_i^*}{\partial y_i} \right]_{Y_j} \frac{d\psi}{dy_i} = \int_{Y_i} [a]_{Y_j} \frac{d\psi}{dy_i}, \quad \forall \psi \in H_{\sharp}^1(Y_i)$$

Then, one has, for a.e.  $x \in \Omega$ , that:

$$\left[ a \frac{\partial W_i^*}{\partial y_i} \right]_{Y_j} = [a]_{Y_j} + C_{ii}(x). \tag{20}$$

Using Assumption 2.16 and dividing Equation (20) by  $a_i$ , we have:

$$\left[ a_j \frac{\partial W_i^*}{\partial y_i} \right]_{Y_j} = [a_j]_{Y_j} + \frac{C_{ii}}{a_i}.$$



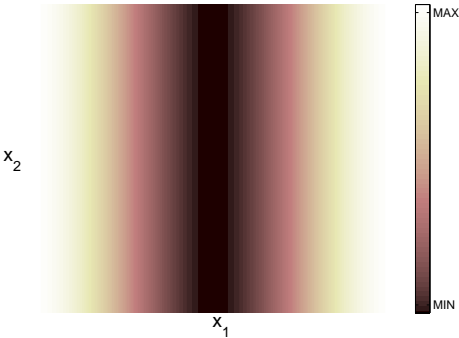

Figure 2: Normalized gap (no roughness patterns)

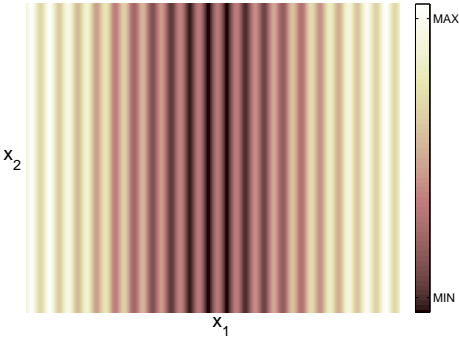

Figure 3: Normalized gap with transverse roughness patterns

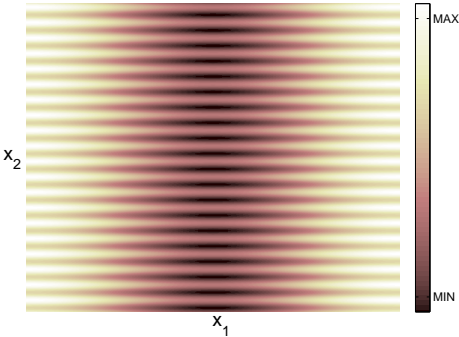

Figure 4: Normalized gap with longitudinal roughness patterns

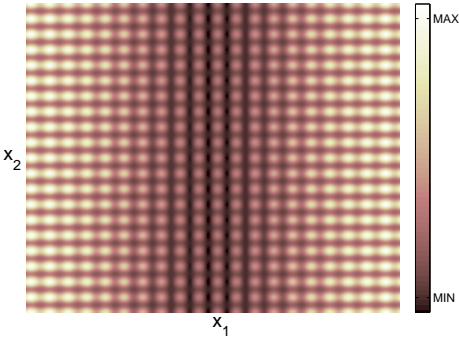

Figure 5: Normalized gap with two dimensional roughness patterns

Now, averaging on the  $y_j$  variable and using the  $Y$  periodicity of  $W_i^*$  give us

$$0 = \tilde{a}_j + C_{ii} \widetilde{a_i^{-1}},$$

so that  $C_{ii}(x) = -\frac{\tilde{a}_j}{a_i^{-1}}$ . Moreover, using the definition of  $\mathcal{A}_{ii}$  (see Theorem 2.10) and Equation (20), one has  $C_{ii}(x) = -\mathcal{A}_{ii}(x)$ , so that

$$\mathcal{A}_{ii}(x) = \frac{\tilde{a}_j}{a_i^{-1}}(x), \quad i = 1, 2.$$

■ *Non-diagonal terms of the matrix.* For this, let  $i, j \in \{1, 2\}$ ,  $j \neq i$ . Recalling the variational formulation of problem  $(\mathcal{M}_i^*)$  ( $i = 1, 2$ ) and using a test function only depending on  $y_j$ , one has:

$$\int_{Y_j} \left[ a \frac{\partial W_i^*}{\partial y_j} \right]_{Y_i} \frac{d\psi}{dy_j} = 0, \quad \forall \psi \in H_{\#}^1(Y_j).$$

Then, for a.e.  $x \in \Omega$ , we have:

$$\left[ a \frac{\partial W_i^*}{\partial y_j} \right]_{Y_i} = C_{ij}(x). \tag{21}$$

Using Assumption 2.16, dividing by  $a_j$ , averaging on the  $y_i$  variable and since  $W_i^*$  is  $Y$  periodic, we get that  $C_{ij}(x) = 0$  (for  $i \neq j$ ). Moreover, using the definition of  $\mathcal{A}_{ij}$  (see Theorem 2.10) and Equation (21), one has  $C_{ij}(x) = -\mathcal{A}_{ij}(x)$  so that  $\mathcal{A}_{ij}(x) = 0$  ( $i \neq j$ ). □

**Lemma 2.18** *Under Assumption 2.16, we deduce that:*

$$\underline{b}^0 = \begin{pmatrix} \Xi_1 b_1^* \\ 0 \end{pmatrix}, \tag{22}$$

where the following relationships hold:

$$0 \leq \Xi_1 \leq 1 \quad \text{and} \quad p_0 (1 - \Xi_1) = 0 \quad \text{a.e. in } \Omega.$$

Moreover, the homogenized coefficient  $b_1^*$  satisfies:

$$b_1^*(x) = \left[ \frac{1}{a_1^{-1}} \left( \frac{\widetilde{b}}{a_1} \right) \right](x). \tag{23}$$

*Proof.* The first part of the proof lies in the determination of vector  $\underline{b}_0$ . In the second part, we calculate the homogenized coefficient  $b_1^*$ .

■ *1st part - Computation of the components of vector  $\underline{b}_0$ :*

- Let us study the first term of vector  $\underline{b}^0$ . Thus, denoting  $w_1 = \chi_1^* - \chi_1^0$  and combining problems  $(\mathcal{N}_1^*)$  and  $(\mathcal{N}_1^0)$ , one gets, for a.e.  $x \in \Omega$ , that:

$$\int_Y a \nabla_y w_1 \nabla_y \psi = \int_Y b(1 - \theta_0) \frac{\partial \psi}{\partial y_1}, \quad \forall \psi \in H_{\#}^1(Y).$$

Now, using a test function only depending on  $y_1$ , one has:

$$\int_{Y_1} \left[ a \frac{\partial w_1}{\partial y_1} \right]_{Y_2} \frac{d\psi}{dy_1} = \int_{Y_1} \left[ b (1 - \theta_0) \right]_{Y_2} \frac{d\psi}{dy_1}, \quad \forall \psi \in H_{\sharp}^1(Y_1).$$

Then, for a.e.  $x \in \Omega$ , we get:

$$\left[ a \frac{\partial w_1}{\partial y_1} \right]_{Y_2} = \left[ b (1 - \theta_0) \right]_{Y_2} + C(x), \quad (24)$$

where  $C(x)$  is an additive constant only depending on  $x$ . Next, using Assumption 2.16, dividing by  $a_1$ , averaging on the  $y_2$  variable and using the  $Y$  periodicity of  $w_1$ , we deduce the following equality

$$\left[ (1 - \theta_0) \frac{b}{a_1} \right] + C(x) \widetilde{a_1^{-1}} = 0.$$

Now, from Proposition 2.6 and Assumption 2.16, it is easy to get  $C(x) \leq 0$ . Then, averaging Equation (24) on the  $y_1$  variable, we obtain that

$$\widetilde{(\theta_0 b)} - \left( a \frac{\partial \chi_1^0}{\partial y_1} \right) \leq \widetilde{b} - \left( a \frac{\partial \chi_1^*}{\partial y_1} \right), \quad \text{i.e.} \quad b_1^0 \leq b_1^*.$$

Next, applying the earlier method to the variational formulation of problem  $(\mathcal{N}_1^0)$ , it is easy to conclude  $0 \leq b_1^0$  ( $i = 1, 2$ ).

- Let us now study the second term of vector  $b^0$ . Applying the same method (as earlier) to the variational formulation of problem  $(\mathcal{N}_1^0)$ , one has:

$$\int_{Y_2} \left[ a \frac{\partial \chi_1^0}{\partial y_2} \right]_{Y_1} \frac{d\psi}{dy_2} = 0, \quad \forall \psi \in H_{\sharp}^1(Y_2).$$

Then, one gets:

$$\left[ a \frac{\partial \chi_1^0}{\partial y_2} \right]_{Y_1} = 0, \quad \text{in } H_{\sharp}^1(Y_2)/\mathbb{R}.$$

From the previous equality, one obtains:

$$\left[ a \frac{\partial \chi_1^0}{\partial y_2} \right]_{Y_1} = C(x), \quad (25)$$

for a.e.  $x \in \Omega$ , where  $C(x)$  is an additive constant only depending on  $x$ . Next, using Assumption 2.16, dividing by  $a_2$ , averaging on the  $y_2$  variable and using the  $Y$  periodicity of  $\chi_1^0$ , we get that  $C(x) = 0$ . So, from Equation (25), we deduce:

$$-\left( a \frac{\partial \chi_1^0}{\partial y_2} \right) = 0, \quad \text{i.e.} \quad b_2^0 = 0.$$

With the earlier method applied to the variational formulation of problem  $(\mathcal{N}_1^*)$ , it is easy to conclude that  $b_2^* = 0$ .

Now, since we have proved that  $0 \leq b_1^0 \leq b_1^*$  and  $0 = b_2^0 = b_2^*$ , using the definitions of  $\Xi_i$  ( $i = 1, 2$ ), it is easy to conclude that Equation (22) and property  $0 \leq \Xi_1 \leq 1$  a.e. in  $\Omega$  hold. Moreover, property  $p_0 (1 - \Xi_1) = 0$  a.e. in  $\Omega$  is obtained from Proposition 2.7 and the definition of  $\Xi_1$ . Thus, it remains to calculate the homogenized coefficient  $b_1^*$ .

■ *2nd part - Computation of  $b_1^*$ :*

First, considering problem  $(\mathcal{N}_1^*)$ , one gets:

$$\int_Y a \nabla_y \chi_1^* \nabla_y \psi = \int_Y b \frac{\partial \psi}{\partial y_1}, \quad \forall \psi \in H_{\#}^1(Y),$$

for a.e.  $x \in \Omega$ . Next, using a test function only depending on  $y_1$ , one has:

$$\int_{Y_1} \left[ a \frac{\partial \chi_1^*}{\partial y_1} \right]_{Y_2} \frac{d\psi}{dy_1} = \int_{Y_1} [b]_{Y_2} \frac{d\psi}{dy_1}, \quad \forall \psi \in H_{\#}^1(Y_1).$$

Then,

$$\left[ a \frac{\partial \chi_1^*}{\partial y_1} \right]_{Y_2} = [b]_{Y_2} + C_1^*(x), \tag{26}$$

for a.e.  $x \in \Omega$ , where  $C_1^*(x)$  is an additive constant only depending on  $x$ . Using Assumption 2.16, dividing by  $a_1$ , averaging on the  $y_2$  variable and using the  $Y$  periodicity of  $\chi_1^*$ , leads to the following equality:

$$\left[ \frac{b}{a_1} \right] + C_1^*(x) \tilde{a}_1 = 0. \tag{27}$$

Next, from the definition of  $b_1^*$  (see Theorem 2.10) and Equation (26), we deduce that  $C_1^*(x) = -b_1^*(x)$  so that, from Equation (27), we conclude the proof.  $\square$

**Lemma 2.19** *Under Assumption 2.16, it follows that*

$$\Xi_1(x) = \left[ \frac{1}{\left( \frac{b}{a_1} \right)} \left( \frac{\theta_0 b}{a_1} \right) \right] (x). \tag{28}$$

*Proof.* Notice that  $b_1^0$  can be calculated by using the same method which allowed us to obtain  $b_1^*$  in the proof of Lemma 2.18, just replacing problem  $(\mathcal{N}_1^*)$ , by problem  $(\mathcal{N}_1^0)$ . Then, we have

$$b_1^0(x) = \frac{1}{a_1^{-1}} \left[ \frac{\theta_0 b}{a_1} \right] (x). \tag{29}$$

The definition of  $\Xi_1$  (see Theorem 2.10), Equations (23) and (29) conclude the proof.  $\square$

To summarize the earlier results, we establish the following homogenized problem:

**Theorem 2.20** *Under Assumption 2.16, the homogenized problem is:*

$$(\mathcal{P}_\theta^*) \left\{ \begin{array}{l} \text{Find } (p_0, \Xi) \in V_a \times L^\infty(\Omega) \text{ such that:} \\ \int_{\Omega} \mathcal{A} \cdot \nabla p_0 \nabla \phi = \int_{\Omega} \Xi b_1^* \frac{\partial \phi}{\partial x_1}, \quad \forall \phi \in V_0 \\ p_0 \geq 0, \quad p_0 (1 - \Xi) = 0, \quad 0 \leq \Xi \leq 1, \quad \text{a.e. in } \Omega \end{array} \right.$$

with the following homogenized coefficients:

$$\mathcal{A} = \begin{pmatrix} \widetilde{\widetilde{a_2}} & 0 \\ \widetilde{\widetilde{a_1^{-1}}} & \\ 0 & \widetilde{\widetilde{a_1}} \\ & \widetilde{\widetilde{a_2^{-1}}} \end{pmatrix}, \quad b_1^*(x) = \left[ \frac{1}{\widetilde{\widetilde{a_1^{-1}}}} \cdot \widetilde{\left( \frac{\widetilde{b}}{a_1} \right)} \right](x)$$

Moreover  $(\mathcal{P}_\theta^*)$  admits at least  $(p_0, \Xi)$  as a solution, where

$$\Xi(x) = \left[ \frac{1}{\widetilde{\widetilde{\left( \frac{b}{a_1} \right)}}} \cdot \widetilde{\left( \frac{\theta_0 b}{a_1} \right)} \right](x) \quad (30)$$

and  $(p_0, \theta_0)$  is the two-scale limit of  $(p_\varepsilon, \theta_\varepsilon)$  (solution of problem  $(\mathcal{P}_\theta^\varepsilon)$ ).

**Remark 2.21** In the lubrication problem, Assumption 2.16 implies that the gap between the two surfaces is described by the function:

$$h\left(x, \frac{x}{\varepsilon}\right) = h_1\left(x, \frac{x_1}{\varepsilon}\right) h_2\left(x, \frac{x_2}{\varepsilon}\right)$$

In this case, the homogenized coefficients are the following ones:

$$\mathcal{A} = \begin{pmatrix} \widetilde{\widetilde{h_2^3}} & 0 \\ \widetilde{\widetilde{h_1^{-3}}} & \\ 0 & \widetilde{\widetilde{h_1^3}} \\ & \widetilde{\widetilde{h_2^{-3}}} \end{pmatrix}, \quad b_1^*(x) = \left[ \frac{\widetilde{\widetilde{h_1^{-2}}}}{\widetilde{\widetilde{h_1^{-3}}}} \widetilde{h_2} \right](x)$$

and we get the precise link between the microscopic cavitation and the macroscopic cavitation, i.e.

$$\Xi(x) = \left[ \frac{1}{\widetilde{\widetilde{h_2 h_1^{-2}}}} \cdot \widetilde{\left( \frac{\theta_0 h_2}{h_1^2} \right)} \right](x) \quad (31)$$

### Theorem 2.22

(i) Under Assumption 2.16, problem  $(\mathcal{P}_\theta^*)$  admits at least a solution  $(p_0, \Xi)$ . Moreover, the pressure  $p_0$  is unique, and if there exists a set of positive measure where  $p_0(x_1, x_2) > 0$ , for any  $x_2 > 0$ , then the saturation  $\Xi$  is unique.

(ii) If  $b^*$  can be written under the form  $b^*(x_1, x_2) = b_1^*(x_1)b_2^*(x_2)$ , problem  $(\mathcal{P}_\theta^*)$  admits a unique solution.

*Proof.* For (i), existence of a solution is stated in Theorem 2.20, by means of construction via the two-scale convergence techniques. Uniqueness of the pressure and, under the additional assumption, of the saturation is obtained as in Theorem 1.8. For (ii), the result is obtained as in Corollary 1.9.  $\square$

**Remark 2.23** A primal “naive” attempt leading to the homogenized problem would be to determine an equation satisfied by the weak limits of  $(p_\varepsilon, \theta_\varepsilon)$ , namely  $(p_0, \widetilde{\theta_0})$ . Interestingly, the weak limit of the pressure does appear in the homogenized problem, but the macroscopic homogenized saturation  $\Xi$  is a modified average of  $\theta_0$ , weighted by the roughness effects through the influence of functions  $h_i$ .

It is interesting to notice that Assumption 2.16 allows us to solve the four difficulties that we could not overcome in the most general case (see Remark 2.11). In particular, there is one single saturation function; the homogenized problem can be numerically solved using algorithms applied to the roughless problem; and it is easy, under additional realistic assumptions, to obtain a uniqueness result on both pressure and saturation. Moreover, Assumption 2.16 includes some important particular cases in terms of mechanical applications: transverse and longitudinal roughness. The results are easily deduced from Theorem 2.22 and given, in the next results, for a strong formulation.

**Corollary 2.24** *If  $h$  does not depend on  $y_2$  (transverse roughness), then the homogenized problem can be written as:*

$$\begin{cases} \frac{\partial}{\partial x_1} \left[ \frac{1}{\widetilde{h^{-3}}} \frac{\partial p_0}{\partial x_1} \right] + \frac{\partial}{\partial x_2} \left[ \widetilde{h^3} \frac{\partial p_0}{\partial x_2} \right] = \frac{\partial}{\partial x_1} \left[ \Xi \frac{\widetilde{h^{-2}}}{\widetilde{h^{-3}}} \right], & x \in \Omega, \\ p_0(x) \geq 0, \quad p_0(x) (1 - \Xi(x)) = 0, \quad 0 \leq \Xi(x) \leq 1, & x \in \Omega, \end{cases}$$

with the following boundary conditions:

$$\begin{aligned} p_0 = 0 \text{ on } \Gamma_0 \text{ and } p_0 = p_a \text{ on } \Gamma_a & \quad (\text{Dirichlet conditions}) \\ \Xi \frac{\widetilde{h^{-2}}}{\widetilde{h^{-3}}} - \frac{1}{\widetilde{h^{-3}}} \frac{\partial p_0}{\partial x_1} \text{ and } p_0 \text{ are } 2\pi x_1 \text{ periodic} & \quad (\text{periodic conditions}) \end{aligned}$$

**Corollary 2.25** *If  $h$  does not depend on  $y_1$  (longitudinal roughness), then the homogenized problem can be written as:*

$$\begin{cases} \frac{\partial}{\partial x_1} \left[ \widetilde{h^3} \frac{\partial p_0}{\partial x_1} \right] + \frac{\partial}{\partial x_2} \left[ \frac{1}{\widetilde{h^{-3}}} \frac{\partial p_0}{\partial x_2} \right] = \frac{\partial}{\partial x_1} \left[ \Xi \widetilde{h} \right], & x \in \Omega, \\ p_0(x) \geq 0, \quad p_0(x) (1 - \Xi(x)) = 0, \quad 0 \leq \Xi(x) \leq 1, & x \in \Omega, \end{cases}$$

with the following boundary conditions:

$$\begin{aligned} p_0 = 0 \text{ on } \Gamma_0 \text{ and } p_0 = p_a \text{ on } \Gamma_a & \quad (\text{Dirichlet conditions}) \\ \Xi \widetilde{h} - \widetilde{h^3} \frac{\partial p_0}{\partial x_1} \text{ and } p_0 \text{ are } 2\pi x_1 \text{ periodic} & \quad (\text{periodic conditions}) \end{aligned}$$

Under Assumption 2.16, the homogenized problem is similar to the  $\varepsilon$  dependent one, since there is one single saturation function. This assumption, imposing a particular form of the roughness, seems to be strong but it allows us to take into account some two dimensional roughness effects. Moreover, it is somewhat surprising to see that passing from the classical homogenized equation (without cavitation) (see [13]) to the one obtained in our paper (including cavitation) only needs to introduce a saturation in the right hand side; in other terms, comparing the homogenized Reynolds equations - with or without cavitation -, the homogenized coefficients are not modified, although the Elrod-Adams model introduces a strong nonlinearity through the saturation function and its properties.

In the next subsection, we deal with oblique roughness. Obviously, this case does not fall into Assumption 2.16 which enables us to completely overcome the mentioned difficulties stated in the general case. However, it seems that a change of variables could allow us to recover a structure in which Assumption 2.16 is satisfied. We will see that it is not really the case and that the change of variables will introduce additional terms which are not fully controlled by the homogenization process; nevertheless, it allows us to define, in a rigorous way, two homogenized saturation functions, thus describing anisotropic phenomena on the cavitation. This structure can be considered as an intermediary one between the general case and the microvariables separation case.

### 2.4.2 Oblique roughness

Let us consider the mapping  $\mathcal{F}_\gamma$  defined as:

$$\mathcal{F}_\gamma : \mathbb{R}^2 \longrightarrow \mathbb{R}^2, \quad \begin{cases} X_1^\gamma(x) = \cos \gamma x_1 + \sin \gamma x_2 \\ X_2^\gamma(x) = -\sin \gamma x_1 + \cos \gamma x_2 \end{cases}, \quad \text{with } \begin{cases} x \longrightarrow X = \mathcal{F}_\gamma(x) \end{cases}$$

We suppose that the effective gap can be described as follows:

**Assumption 2.26** *For a given angle  $\gamma$ , let be  $h_\varepsilon$  a function such that*

$$\forall x \in \Omega, \quad h_\varepsilon(x) = h_1 \left( x, \frac{X_1^\gamma(x)}{\varepsilon} \right) h_2 \left( x, \frac{X_2^\gamma(x)}{\varepsilon} \right),$$

with  $0 < m_i^0 \leq h_i \leq M_i^0$  a.e. in  $\Omega$  ( $i = 1, 2$ ).

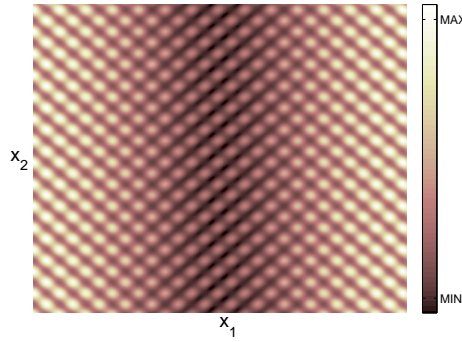

Figure 6: Normalized gap with oblique roughness patterns

Obviously, heights satisfying Assumption 2.26 (see for instance FIG.6) do not satisfy Assumption 2.16 (except for particular values of  $\gamma$ ). Let us drop the overscripts  $\gamma$  (for the sake of simplicity). Now, we say that  $x = (x_1, x_2)$  (*resp.*  $X = (X_1, X_2)$ ) denotes the original (*resp.* new) spatial coordinates. So, introducing the vector  $e_{-\gamma} = (\cos \gamma, -\sin \gamma)$ , problem  $(\mathcal{P}_\theta^\varepsilon)$  can be described in the  $X$  coordinates as follows:

$$\left( \check{\mathcal{P}}_\theta^\varepsilon \right) \left\{ \begin{array}{l} \text{Find } (\check{p}_\varepsilon, \check{\theta}_\varepsilon) \in \check{V}_a \times L^\infty(\check{\Omega}) \text{ such that:} \\ \int_{\check{\Omega}} \check{h}_\varepsilon^3(X) \nabla \check{p}_\varepsilon(X) \nabla \phi(X) dX = \int_{\check{\Omega}} \check{\theta}_\varepsilon(X) \check{h}_\varepsilon(X) e_{-\gamma} \nabla \phi(X) dX, \quad \forall \phi \in \check{V}_0, \\ \check{p}_\varepsilon \geq 0, \quad \check{p}_\varepsilon (1 - \check{\theta}_\varepsilon) = 0, \quad 0 \leq \check{\theta}_\varepsilon \leq 1, \quad \text{a.e. in } \check{\Omega}, \end{array} \right.$$

where  $\check{f}(X) = f(x)$  and  $\check{\Omega} = \mathcal{F}_\gamma(\Omega)$ , with the following functional spaces:

$$\begin{aligned} \check{V}_a &= \left\{ \phi \in H^1(\check{\Omega}), \phi|_{\Gamma_l} = \phi|_{\Gamma_r}, \phi|_{\Gamma_0} = 0, \phi|_{\Gamma_a} = \check{p}_a \right\}, \\ \check{V}_0 &= \left\{ \phi \in H^1(\check{\Omega}), \phi|_{\Gamma_l} = \phi|_{\Gamma_r}, \phi|_{\Gamma_0} = 0, \phi|_{\Gamma_a} = 0 \right\}, \end{aligned}$$

where  $\Gamma_l$  (*resp.*  $\Gamma_r$ ) denotes the left (*resp.* right) lateral boundary.

**Remark 2.27** *In the new coordinates, one has*

$$\check{h}_\varepsilon(X) = \check{h}_1 \left( X, \frac{X_1}{\varepsilon} \right) \check{h}_2 \left( X, \frac{X_2}{\varepsilon} \right).$$

From now on, we denote  $\check{a}_i(X, y_i) = \check{h}_i^3(X, y_i)$  and  $\check{b}_i(X, y_i) = \check{h}_i(X, y_i)$  ( $i = 1, 2$ ). Then  $\check{a}(X, y) = \check{a}_1(X, y_1) \check{a}_2(X, y_2)$  and  $\check{b}(X, y) = \check{b}_1(X, y_1) \check{b}_2(X, y_2)$  satisfy Assumption 2.16 in the  $X$  coordinates.

**Remark 2.28** *The formulation of the lubrication problem in the new coordinates system is equivalent to a generalized Reynolds problem as it happens with an oblique flow direction  $e_{-\gamma} = (\cos \gamma, -\sin \gamma)$ , instead of  $e = (1, 0)$  in the classical one.*

**Theorem 2.29** *We have the following convergences:*

(i) *There exists  $\check{p}_0 \in H^1(\check{\Omega})$  such that, up to a subsequence,*

$$\check{p}_\varepsilon \rightharpoonup \check{p}_0, \text{ in } H^1(\check{\Omega}) \quad \text{and} \quad \check{p}_\varepsilon \rightarrow \check{p}_0, \text{ in } L^2(\check{\Omega}).$$

*Moreover  $\check{p}_0 \in \check{V}_a$ , and  $\check{p}_0 \geq 0$  a.e. in  $\check{\Omega}$ .*

(ii)  *$\check{p}_\varepsilon(X)$  two-scale converges to  $\check{p}_0(X)$ . Moreover, there exists  $\check{p}_1(X, y) \in L^2(\check{\Omega}; H^1_\#(Y)/\mathbb{R})$  and a subsequence  $\varepsilon'$  still denoted  $\varepsilon$  such that  $\nabla \check{p}_\varepsilon(X)$  two-scale converges to  $\nabla \check{p}_0(X) + \nabla_y \check{p}_1(X, y)$ .*

(iii) *There exists  $\check{\theta}_0(X, y) \in L^2(\check{\Omega} \times Y)$  and a subsequence  $\varepsilon''$  still denoted  $\varepsilon$  such that  $\check{\theta}_\varepsilon(X)$  two-scale converges to  $\check{\theta}_0(X, y)$ .*

*Proof.* The result is easily obtained after establishing a priori estimates which do not depend on  $\varepsilon$  (see Subsection 2.1). □

**Theorem 2.30** *Under Assumption 2.26, one gets the following homogenized problem in the  $X$  coordinates:*

$$(\check{\mathcal{P}}_\theta^*) \left\{ \begin{array}{l} \text{Find } (\check{p}_0, \check{\Xi}_1, \check{\Xi}_2) \in \check{V}_a \times L^\infty(\check{\Omega}) \times L^\infty(\check{\Omega}) \text{ such that:} \\ \int_{\check{\Omega}} \check{\mathcal{A}}(X) \cdot \nabla \check{p}_0(X) \nabla \phi(X) = \int_{\check{\Omega}} \check{\mathcal{B}}^0(X) \cdot e_{-\gamma} \nabla \phi(X), \quad \forall \phi \in \check{V}_0, \\ \check{p}_0 \geq 0, \quad \check{p}_0 (1 - \check{\Xi}_i) = 0, \quad 0 \leq \check{\Xi}_i \leq 1, \quad (i = 1, 2) \quad \text{a.e. in } \check{\Omega}, \end{array} \right.$$

*with the following expressions:*

$$\check{\mathcal{A}} = \begin{pmatrix} \frac{\check{a}_2}{\check{a}_1^{-1}} & 0 \\ 0 & \frac{\check{a}_1}{\check{a}_2^{-1}} \end{pmatrix}, \quad \check{\mathcal{B}}^0 = \begin{pmatrix} \check{\Xi}_1 \check{b}_1^* & 0 \\ 0 & \check{\Xi}_2 \check{b}_2^* \end{pmatrix},$$

*and*

$$\check{b}_i^*(X) = \left[ \frac{1}{\check{a}_i^{-1}} \cdot \widetilde{\left( \frac{\check{b}}{\check{a}_i} \right)} \right](X), \quad i = 1, 2.$$

*Moreover problem  $(\check{\mathcal{P}}_\theta^*)$  admits  $(\check{p}_0, \check{\Xi}_1, \check{\Xi}_2)$  as a solution, where*

$$\check{\Xi}_i(X) = \left[ \frac{1}{\check{a}_i^{-1}} \cdot \widetilde{\left( \frac{\check{\theta}_0 \check{b}}{\check{a}_i} \right)} \right](X), \quad i = 1, 2$$

*and  $(\check{p}_0, \check{\theta}_0)$  is the two-scale limit of  $(\check{p}_\varepsilon, \check{\theta}_\varepsilon)$  (solution of problem  $(\check{\mathcal{P}}_\theta^\varepsilon)$ ).*



*Proof.* We use the same techniques as before, the only modification comes from the presence of an additional term in the right-hand side of the equation. We briefly sketch the main steps of the complete proof:

■ *1st step: Properties of the two-scale limits* - Let  $(\check{p}_0, \check{\theta}_0)$  be the two-scale limit of  $(\check{p}_\varepsilon, \check{\theta}_\varepsilon)$  (see Theorem 2.29). Then one has:

- (i)  $\check{p}_0 (1 - \check{\theta}_0) = 0$  in  $L^2(\check{\Omega} \times Y)$ ,
- (ii)  $0 \leq \check{\theta}_0 \leq 1$  a.e. in  $\check{\Omega} \times Y$ .

■ *2nd step: Macro/microscopic decomposition* - Using the classical techniques (previously used in Subsections 2.1 and 2.3), one gets:

- (i) Macroscopic equation:

$$\int_{\check{\Omega}} \left( \int_Y \check{a} [\nabla \check{p}_0 + \nabla_y \check{p}_1] dy \right) \nabla \phi = \int_{\check{\Omega}} \left( \int_Y \check{\theta}_0 \check{b} dy \right) e_{-\gamma} \nabla \phi,$$

for every  $\phi$  in  $\check{V}_0$ .

- (ii) Microscopic equation:

For a.e.  $X \in \check{\Omega}$ ,  $\int_Y \check{a} [\nabla \check{p}_0 + \nabla_y \check{p}_1] \nabla_y \psi dy = \int_Y \check{\theta}_0 \check{b} e_{-\gamma} \nabla_y \psi dy$ ,  
for every  $\psi \in H_{\sharp}^1(Y)$ .

■ *3rd step: Local problems and macroscopic equation* - The local problems  $(\check{\mathcal{M}}_i^*)$ ,  $(\check{\mathcal{N}}_i^*)$  and  $(\check{\mathcal{N}}_i^0)$  are identical to the ones defined in Subsection 2.3 (up to the notations adapted to the  $X$  coordinates). Then, one has:

$$\int_{\check{\Omega}} \check{\mathcal{A}} \cdot \nabla \check{p}_0 \nabla \phi = \int_{\check{\Omega}} \check{\mathcal{B}}^0 \cdot e_{-\gamma} \nabla \phi, \quad \forall \phi \in \check{V}_0,$$

with the following notations:

$$\check{\mathcal{A}} = \begin{pmatrix} \check{a} - \left[ \check{a} \frac{\partial \widetilde{W}_1^*}{\partial y_1} \right] & - \left[ \check{a} \frac{\partial \widetilde{W}_2^*}{\partial y_1} \right] \\ - \left[ \check{a} \frac{\partial \widetilde{W}_1^*}{\partial y_2} \right] & \check{a} - \left[ \check{a} \frac{\partial \widetilde{W}_2^*}{\partial y_2} \right] \end{pmatrix}, \quad \check{\mathcal{B}}^0 = \begin{pmatrix} \check{\Xi}_{11} \check{b}_{11}^* & \check{\Xi}_{12} \check{b}_{12}^* \\ \check{\Xi}_{21} \check{b}_{21}^* & \check{\Xi}_{22} \check{b}_{22}^* \end{pmatrix},$$

using the notations  $(i, j = 1, 2)$ :

$$\check{b}_{ij}^* = \check{b} \delta_{ij} - \left[ \check{a} \frac{\partial \widetilde{\chi}_j^*}{\partial y_i} \right], \quad \check{b}_{ij}^0 = \left[ \check{\theta}_0 \check{b} \right] \delta_{ij} - \left[ \check{a} \frac{\partial \widetilde{\chi}_j^0}{\partial y_i} \right],$$

and defining the following ratios  $(i, j = 1, 2)$ :

$$\check{\Xi}_{ij} = \frac{\check{b}_{ij}^0}{\check{b}_{ij}^*},$$

where  $W_i^*$ ,  $\chi_i^*$  and  $\chi_i^0$  are the solutions of the local problems  $(\check{\mathcal{M}}_i^*)$ ,  $(\check{\mathcal{N}}_i^*)$  and  $(\check{\mathcal{N}}_i^0)$  (consider the analogy with Equations (11), (12) and (13)).

■ *4th step: Simplifications due to Assumption 2.26* - Assumption 2.16 in the  $X$  coordinates (issued from Assumption 2.26) allows us to use the same techniques as in the previous subsection to obtain the simplifications on  $\check{\mathcal{A}}$  and  $\check{\mathcal{B}}^0$ .  $\square$

**Remark 2.31** *The earlier formulation is the weak formulation of a generalized Reynolds-type problem including cavitation. The main difference with the initial problem given in the formulation of  $(\check{\mathcal{P}}_\theta^\varepsilon)$  lies in anisotropic effects on the homogenized coefficients, which is a classical result in homogenization theory, but also on the saturation function.*

**Theorem 2.32** [*Homogenized exact problem*] *Under Assumption 2.26, one gets the following homogenized problem in the  $x$  coordinate:*

$$(\mathcal{P}_\theta^*) \left\{ \begin{array}{l} \text{Find } (p_0, \Xi_1, \Xi_2) \in V_a \times L^\infty(\Omega) \times L^\infty(\Omega) \text{ such that:} \\ \int_\Omega \mathcal{A} \cdot \nabla p_0 \nabla \phi = \int_\Omega \underline{b}_1^0 \frac{\partial \phi}{\partial x_1} + \int_\Omega \underline{b}_2^0 \frac{\partial \phi}{\partial x_2}, \quad \forall \phi \in V_0, \\ p_0 \geq 0, \quad p_0 (1 - \Xi_i) = 0, \quad 0 \leq \Xi_i \leq 1, \quad (i = 1, 2) \quad \text{a.e. in } \Omega, \end{array} \right.$$

with the following expressions:

$$\begin{aligned} \mathcal{A}(x) &= \begin{pmatrix} a_1^*(x) & 0 \\ 0 & a_2^*(x) \end{pmatrix} + (a_1^*(x) - a_2^*(x)) \sin \gamma \begin{pmatrix} -\sin \gamma & \cos \gamma \\ \cos \gamma & \sin \gamma \end{pmatrix}, \\ \underline{b}_1^0(x) &= -(b_1^*(x) \Xi_1(x) - b_2^*(x) \Xi_2(x)) \sin^2 \gamma + b_1^*(x) \Xi_1(x), \\ \underline{b}_2^0(x) &= (b_1^*(x) \Xi_1(x) - b_2^*(x) \Xi_2(x)) \sin \gamma \cos \gamma, \end{aligned}$$

and the following homogenized coefficients ( $i, j = 1, 2$  and  $j \neq i$ ):

$$a_i^*(x) = \frac{\widetilde{h_j^3}}{h_i^{-3}}(x) \quad \text{and} \quad b_i^*(x) = \left[ \frac{\widetilde{h_i^{-2}}}{h_i^{-3}} \widetilde{h_j} \right](x).$$

Moreover, problem  $(\mathcal{P}_\theta^*)$  admits  $(p_0, \Xi_1, \Xi_2)$  as a solution, where

$$\Xi_i(x) = \left[ \frac{1}{\widetilde{h_i^{-2} \widetilde{h_j}}} \left( \frac{\widetilde{\theta_0 h_j}}{h_i^2} \right) \right](x), \quad i, j = 1, 2, \quad j \neq i, \quad (32)$$

and  $(p_0, \theta_0)$  is the two-scale limit of  $(p_\varepsilon, \theta_\varepsilon)$  (solution of problem  $(\check{\mathcal{P}}_\theta^\varepsilon)$ ).

*Proof.* Theorem 2.32 is obtained from Theorem 2.30 using the inverse change of coordinates, with  $\check{f}(X, y) = f(x, y)$ .  $\square$

**Remark 2.33** *Theorem 2.32 implies that we have been able to solve one of the difficulties that raised in the most general case (see Remark 2.11). Indeed there are two saturation functions, but we have proved that they satisfy:  $0 \leq \Xi_i \leq 1$  ( $i = 1, 2$ ), which was not guaranteed in the general case. In this way, the homogenized problem has a structure that is close to the initial one. But, as in the most general case, we cannot prove a uniqueness result with the methods of Section 1, nor can we numerically solve the problem using algorithms that have been previously mentioned, since we still have two saturation functions.*

**Remark 2.34** *Let us recall that, in Theorem 2.10, we wrote the right hand side as  $\underline{b}_i^0 = \Xi_i b_i^*$ , thus defining “fake” saturation functions (since we were not able to prove that  $0 \leq \Xi_i \leq 1$ ). In fact, according to Theorem 2.32,  $\underline{b}_i^0$  should be considered as a combination of  $\Xi_i b_i^*$ , where  $\Xi_i$  can be considered as “real” saturation functions (since they satisfy  $0 \leq \Xi_i \leq 1$ ).*

**Remark 2.35** *Theorem 2.32 gives an example of an homogenized problem with non-diagonal terms in the matrix and additional homogenized coefficients in the second member (see Theorem 2.10 corresponding to the most general case). Indeed, let us try to understand the homogenized problem  $(\mathcal{P}_\theta^\varepsilon)$  in a form that is a perturbation of the homogenized one defined under Assumption 2.16. For this, we define the main term  $A^m$  and the residual term  $A^r$  in the matrix as follows:*

$$A(x) = \underbrace{\begin{pmatrix} a_1^*(x) & 0 \\ 0 & a_2^*(x) \end{pmatrix}}_{A^m(x)} + \underbrace{(a_1^*(x) - a_2^*(x)) \sin \gamma \begin{pmatrix} -\sin \gamma & \cos \gamma \\ \cos \gamma & \sin \gamma \end{pmatrix}}_{A^r(x)}.$$

*In the same way, we introduce in the second member the main component  $b_1^m$  and the residual ones  $b_1^r$  and  $b_2^r$ :*

$$\begin{aligned} b_1^0(x) &= \underbrace{-\left(b_1^*(x) \Xi_1(x) - b_2^*(x) \Xi_2(x)\right) \sin^2 \gamma}_{b_1^r} + \underbrace{\Xi_1(x) b_1^*(x)}_{b_1^m}, \\ b_2^0(x) &= \underbrace{\left(b_1^*(x) \Xi_1(x) - b_2^*(x) \Xi_2(x)\right) \sin \gamma \cos \gamma}_{b_2^r}. \end{aligned}$$

*Let us notice that the main term in the second member only appears in the  $x_1$  direction, corresponding to the flow direction. Moreover neglecting the residual terms in the formulation gives us the classical homogenized problem with  $\gamma = k\pi/2$  ( $k \in \mathbb{Z}$ ) (see Theorem 2.20).*

**Remark 2.36** *Considering the dam problem, an homogenized problem analogous to the initial one cannot be obtained in the most general case, since it is possible to show (see [2, 33, 39]) that there exists the possibility of the non-convergence of the unsaturated regions (i.e.  $\{p_\varepsilon = 0\} \cap \{0 < \theta_\varepsilon < 1\}$ ). But the counter-example developed in the previous references is valid only for initial anisotropic permeability cases. In the lubrication case, this assumption is not relevant and the possibility to state an homogenized problem whose structure is similar to the initial one remains an open question.*

### 3 Numerical methods and results

In this section, the numerical simulation of a microhydrodynamic contact is performed to illustrate the theoretical results of convergence stated in the previous sections. For the numerical solution of the  $\varepsilon$  dependent problems and their corresponding homogenized one, we propose the characteristics method adapted to steady-state problems to deal with the convection term combined with a finite element spatial discretization. Moreover, the maximal monotone nonlinearity associated to the Elrod-Adams model for cavitation is treated by a duality method. The combination of these numerical techniques has been already successfully used in previous papers dealing with hydrodynamic aspects (see [15, 19]), and even with elasto-hydrodynamic aspects (see, for instance, [6, 27]).

#### 3.1 The characteristics method

■ *1st step - Time discretization* - Considering problem  $(\mathcal{P}_\theta)$ , the departure point is the introduction of an artificial dependence on time  $t$  in all the stationary functions, i.e.  $\bar{\psi}(x, t) =$

$\psi(x)$ . By considering the velocity field  $\vec{u} = (-1, 0)$  and the corresponding total derivative operator, i.e.

$$\frac{D}{Dt} = \frac{\partial}{\partial t} + \vec{u} \cdot \nabla = -\frac{\partial}{\partial x_1},$$

then the stationary problem  $(\mathcal{P}_\theta)$  gives place to the artificial evolutive one

$$\int_{\Omega} \theta h \frac{D\bar{\psi}}{Dt} dx + \int_{\Omega} h^3 \nabla p \nabla \bar{\psi} dx = 0 \quad \text{and} \quad \theta \in H(p).$$

Next, we consider the upwinded approximation of the total derivative

$$\frac{D\bar{\psi}}{Dt} \approx \frac{\psi(x) - \psi(X^k(x))}{k},$$

where  $k$  is an artificial time step and  $X^k(x)$  denotes the position of a particle placed in the point  $x$  at time  $t - k$  moving along the integral path of the velocity field  $\vec{u}$ , i.e.  $X^k(x) = X(x, t; t - k)$ .  $X$  is the solution of the O.D.E. of characteristics

$$\frac{d}{d\tau}(X(x, t; \tau)) = u(X(x, t; \tau)) \quad \text{and} \quad X(x, t; t) = x.$$

In this way, the time discretized problem is written as

$$\int_{\Omega} \theta h \frac{\psi - \psi \circ X^k}{k} dx + \int_{\Omega} h^3 \nabla p \nabla \psi dx = 0 \quad \text{and} \quad \theta \in H(p),$$

which suggests to move the term containing  $\psi \circ X^k$  into the right hand side of the equation and to look for the solution of this evolutive problem when  $t \rightarrow +\infty$  by means of step by step algorithm in time.

■ *2nd step - Computation of one time step* - For each time step  $t^n = n \Delta t$ , the finite element discretization in space defines the final discretized problem

$$(\mathcal{P}_\Delta) \left\{ \begin{array}{l} \frac{1}{k} \int_{\Omega} \theta_h^{n+1} h \psi_h dx + \int_{\Omega} h^3 \nabla p_h^{n+1} \nabla \psi_h dx = \frac{1}{k} \int_{\Omega} \theta_h^n h (\psi_h \circ X^k) dx, \quad \forall \phi_h \in V_{oh}, \\ \theta_h^{n+1}(b) \in H(p^{n+1}(b)), \quad \forall b \text{ node of } \tau_h, \end{array} \right.$$

where  $\tau_h$  is the triangularization of the domain. The finite element spaces are defined as

$$\begin{aligned} V_h &= \{v_h \in C^0(\Omega), v_h|_E \in P_1, \forall E \in \tau_h\}, \\ V_{oh} &= \{v_h \in V_h, v_h|_{\Gamma_a \cup \Gamma_0} = 0\}. \end{aligned}$$

Each iteration of the characteristics algorithms requires to solve the nonlinear problem  $(\mathcal{P}_\Delta)$ . For this, we use the new unknown,  $r^{n+1}$ , defined by

$$r^{n+1} \in H(p^{n+1}) - \delta p^{n+1} \quad \text{in } \Omega,$$

$\delta$  being an arbitrary positive real constant. Then, dropping the subscripts  $h$ ,

$$(\mathcal{P}_\Delta^\delta) \left\{ \begin{array}{l} \frac{\delta}{k} \int_{\Omega} p^{n+1} h \psi dx + \int_{\Omega} h^3 \nabla p^{n+1} \nabla \psi dx \\ \quad = \frac{1}{k} \int_{\Omega} \theta_h^n h (\psi \circ X^k) dx - \frac{1}{k} \int_{\Omega} r^{n+1} h \psi dx, \quad \forall \phi_h \in V_{oh}, \\ r^{n+1} = H_\lambda^\delta(p^{n+1} + \lambda r^{n+1}), \end{array} \right.$$

where  $H_\lambda^\delta$  denotes the Yosida approximation of  $H - \delta I$ ,  $I$  being the identity operator. The fixed-point algorithm to solve  $(\mathcal{P}_\Delta^\delta)$  proceeds as follows: at the beginning of each iteration we know  $r$ . Then we compute  $p$  as the solution of the linear problem  $(\mathcal{P}_\Delta^\delta)$ -(i) and update  $r$  with  $(\mathcal{P}_\Delta^\delta)$ -(ii).

### 3.2 Numerical tests

We address the numerical simulation of journal bearing devices with circumferential supply of lubricant (see FIG.7 and 8).

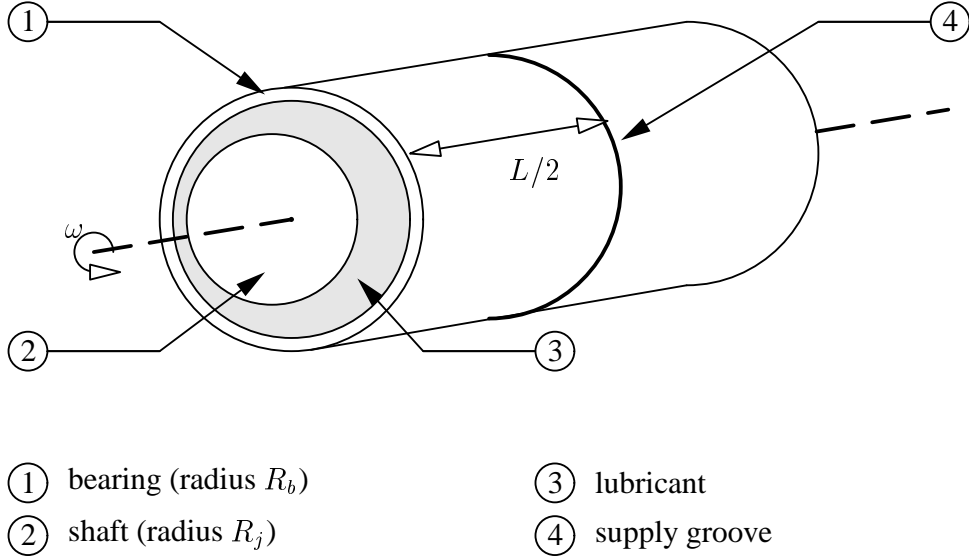

Figure 7: Journal bearing

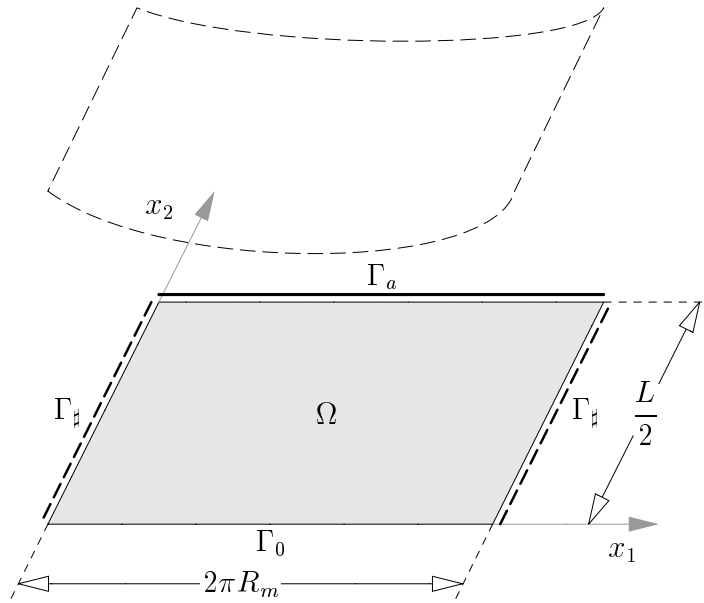

Figure 8: Journal bearing (developped configuration)

Indeed we simulate a journal-bearing device whose length is  $L = 0.075 \text{ m}$ , mean radius  $R_m = (R_b + R_j)/2 = 0.0375 \text{ m}$  ( $R_b$  and  $R_j$  being the bearing and journal radii, respectively) and the clearance is  $c = R_b - R_j = 0.001 \text{ m}$ . The supply pressure is  $p_a = 100000 \text{ Pa}$  or  $p_a = 150000 \text{ Pa}$  (according to the case study), the lubricant viscosity is  $\mu = 0.03382 \text{ Pa}\cdot\text{s}$  and the velocity of the journal is taken to  $v_0 = 30 \text{ m/s}$ . Moreover, the roughness gap between the two surfaces is given by:

$$h(x) = c \left( 1 + \rho \cos \left( \frac{x_1}{R_m} \right) \right), \quad x = (x_1, x_2) \in (0, 2\pi R_m) \times \left( 0, \frac{L}{2} \right),$$

where the eccentricity  $\rho$  varies from 0.6 to 0.8 (according to the case study). The classical Reynolds problem, in real variables, should be posed as:

$$\begin{cases} \nabla \cdot \left( \frac{h_s^3}{6\mu} \nabla p \right) = v_0 \frac{\partial}{\partial x_1} (\theta h_s), & \text{in } (0, 2\pi R_m) \times (0, L/2), \\ p \geq 0, \quad p(1 - \theta) = 0, \quad 0 \leq \theta \leq 1, & \text{in } (0, 2\pi R_m) \times (0, L/2), \end{cases}$$

with the boundary conditions:

$$\begin{aligned} p &= 0, \text{ on } ]0, 2\pi R_m[ \times \{0\} \text{ and } p = p_a, \text{ on } (0, 2\pi R_m) \times \{L/2\}, \\ p \text{ and } v_0 \theta h_s - \frac{h_s^3}{6\mu} \frac{\partial p}{\partial x_1} &\text{ are } 2\pi R_m x_1 \text{ periodic.} \end{aligned}$$

Now let us introduce the dimensionless coordinates and quantities that provide the effective system to solve (see [6]):

$$\begin{aligned} X_1 &= \frac{x_1}{R_m}, & X_2 &= \frac{2 y_2}{L}, & H_s(X) &= \frac{h_s(x)}{c}, \\ P &= \frac{c^2}{6v_0 R_m \mu} p, & P_a &= \frac{c^2}{6v_0 R_m \mu} p_a, & \kappa &= \frac{2R_m}{L}. \end{aligned}$$

Then, the dimensionless Reynolds problem becomes:

$$\begin{cases} \frac{\partial}{\partial X_1} \left( H_s^3 \frac{\partial P}{\partial X_1} \right) + \kappa^2 \frac{\partial}{\partial X_2} \left( H_s^3 \frac{\partial P}{\partial X_2} \right) = \frac{\partial}{\partial X_1} (\theta H_s), & \text{in } (0, 2\pi) \times (0, 1), \\ P \geq 0, \quad P(1 - \theta) = 0, \quad 0 \leq \theta \leq 1, & \text{in } (0, 2\pi) \times (0, 1), \end{cases}$$

with the boundary conditions:

$$\begin{aligned} P &= 0, \text{ on } ]0, 2\pi[ \times \{0\} \text{ and } P = P_a, \text{ on } (0, 2\pi) \times \{1\}, \\ P \text{ and } \theta H_s - H_s^3 \frac{\partial P}{\partial X_1} &\text{ are } 2\pi X_1 \text{ periodic,} \end{aligned}$$

and the roughless gap is now  $H_s(X) = 1 + \rho \cos(X_1)$ . Let us now introduce the roughness patterns: we propose in the rough case the following expression for the dimensionless gap:

$$H_\varepsilon(X) = H \left( X, \frac{X}{\varepsilon} \right) = \begin{cases} H_s(X) + h_r \sin \left( \frac{X_1}{\varepsilon} \right), & \text{for transverse roughness,} \\ H_s(X) + h_r \sin \left( 2\pi \frac{X_2}{\varepsilon} \right), & \text{for longitudinal roughness,} \end{cases}$$

where  $h_r$  denotes the amplitude of the roughnesses and  $\varepsilon$  represents the spacing of the roughness. In order to guarantee the positivity of the gap, we choose  $h_r$  so that  $h_r > 1 - \rho$ . The homogenized problem to solve can be written under the form:

$$\begin{cases} \frac{\partial}{\partial X_1} \left( a_1 \frac{\partial P_0}{\partial X_1} \right) + \kappa^2 \frac{\partial}{\partial X_2} \left( a_2 \frac{\partial P_0}{\partial X_2} \right) = \frac{\partial}{\partial X_1} (\Xi b), & \text{in } (0, 2\pi) \times (0, 1), \\ P_0 \geq 0, \quad P_0(1 - \Xi) = 0, \quad 0 \leq \Xi \leq 1, & \text{in } (0, 2\pi) \times (0, 1), \end{cases}$$

with the boundary conditions:

$$\begin{aligned} P_0 &= 0, \text{ on } ]0, 2\pi[ \times \{0\} \text{ and } P_0 = P_a, \text{ on } (0, 2\pi) \times \{1\}, \\ P_0 \text{ and } \Xi b - a_1 \frac{\partial P_0}{\partial X_1} &\text{ are } 2\pi X_1 \text{ periodic.} \end{aligned}$$

In TABLE 1, we present the coefficients  $a_1$ ,  $a_2$  and  $b$  that appear in the homogenized problem for purely transverse and purely longitudinal roughness cases which have been computed with MATHEMATICA Software Package:

	Transverse roughness	Longitudinal roughness
$H(X, Y)$	$H_s(X) + h_r \sin(Y_1)$	$H_s(X) + h_r \sin(2\pi Y_2)$
$a_1(X)$	$2 \frac{(H_s(X)^2 - h_r^2)^{5/2}}{2H_s(X)^2 + h_r^2}$	$H_s(X)^3 + \frac{3}{2} H_s(X) h_r^2$
$a_2(X)$	$H_s(X)^3 + \frac{3}{2} H_s(X) h_r^2$	$2 \frac{(H_s(X)^2 - h_r^2)^{5/2}}{2H_s(X)^2 + h_r^2}$
$b(X)$	$2H_s(X) \frac{H_s(X)^2 - h_r^2}{2H_s(X)^2 + h_r^2}$	$H_s(X)$

Table 1: Hydrodynamic homogenized coefficients

### 3.2.1 Case 1: Transverse roughness tests

Numerical tests have been made for two different regimes: the first one is a realistic regime in terms of the size of the roughness linked to mechanical applications; the second one is a severe unrealistic regime, since the deformability of the surface should be taken into account. However, in both cases, we have considered the following physical data: the eccentricity is  $\rho = 0.6$ . The numerical methods parameters are the following ones: a triangular uniform finite element mesh whose parameters  $\Delta x_1$  and  $\Delta x_2$  are given further, an artificial time step for the characteristics method (see [15])  $\Delta t = \Delta x_1$ ; the Bermudez-Moreno parameters are  $\omega = 1$  and  $\lambda = 1/(2\omega)$ ; the stopping test in all algorithms is equal to  $\delta = 10^{-4}$  (corresponding to the absolute error in the discrete  $L^\infty$  norm between two iterations in time).

■ *Case 1<sup>a</sup>*: The amplitude of the roughness is given by  $\beta/(1 - \rho) = 0.5$ . The mesh parameters are  $\Delta x_1 = 2\pi/600$  and  $\Delta x_2 = 1/50$ , so that we have 60000 triangles and 30651 vertices. Numerical tests illustrate the two-scale convergence results established in previous sections. In particular, FIG.9 and 10 represent the cuts at  $x_2 = 0.0016$  m for the pressure and saturation variables for different numbers of roughness patterns  $N_\varepsilon = 2\pi/\varepsilon$  and the homogenized solution. The figures illustrate the convergence of the pressure but also the behaviour of the cavitation function:

- FIG.9: it illustrates the strong convergence of  $p_\varepsilon$  to  $p_0$  in  $L^2(\Omega)$ .
- FIG.10: as pointed out in Remark 2.14, it is clear that  $\theta_\varepsilon$  converges in  $L^2(\Omega)$  only in a weak sense; in particular, one sees that the amplitude of the gradient explodes when  $\varepsilon \rightarrow 0$ , so that  $\theta_0(x, y)$  actually depends on the  $y$  variable.

Finally, FIG.11 and 12 present the homogenized pressure and saturation in the whole domain.

■ *Case 1<sup>b</sup>*: In this severe regime, the amplitude of the roughness is given by  $\beta/(1 - \rho) = 0.9$ . The mesh parameters are  $\Delta x_1 = 2\pi/400$  and  $\Delta x_2 = 1/50$ , so that we have 40000 triangles and 20451 vertices. FIG.14 and 15 represent the cuts at  $x_2 = 0.0032$  m for the pressure and saturation variables for different numbers of roughness patterns  $N_\varepsilon = 2\pi/\varepsilon$  and the homogenized solution. FIG.14 and 15 illustrate the convergence results. The comments that have been established in Case 1<sup>a</sup> are still valid, even in a severe regime. Let us notice that numerical computations become very difficult when  $N_\varepsilon$  becomes greater than 60: it is, of course, a case which really falls into the scope of homogenization studies and shows the interest of the method.

Finally, let us denote  $r_{N_\varepsilon}$  the residual term

$$r_{N_\varepsilon} = \left\| p_\varepsilon - p_0 \right\|_{L^2(\Omega)}.$$

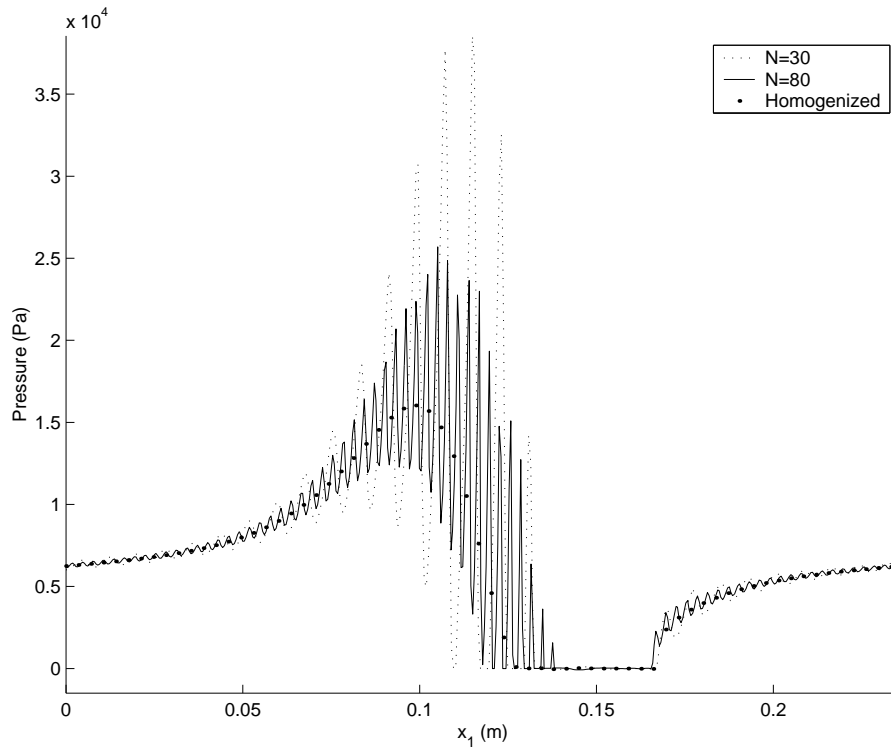

Figure 9: Hydrodynamic pressure at  $x_2 = 0.0016 \text{ m}$  (transverse roughness; case 1<sup>a</sup>)

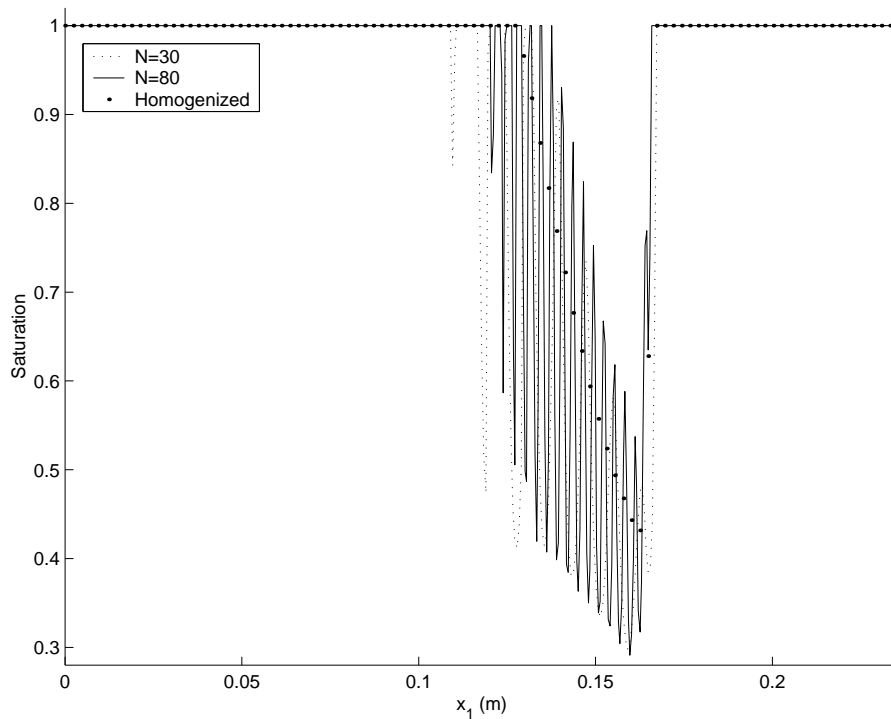

Figure 10: Hydrodynamic saturation at  $x_2 = 0.0016 \text{ m}$  (transverse roughness; case 1<sup>a</sup>)



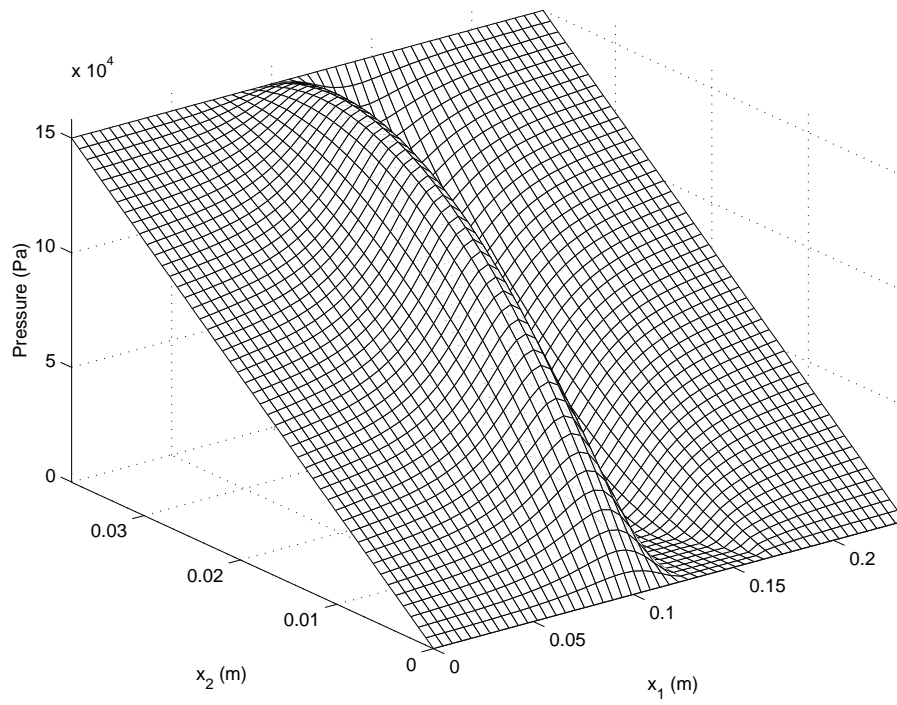

Figure 11: Hydrodynamic homogenized pressure (transverse roughness; case 1<sup>a</sup>)

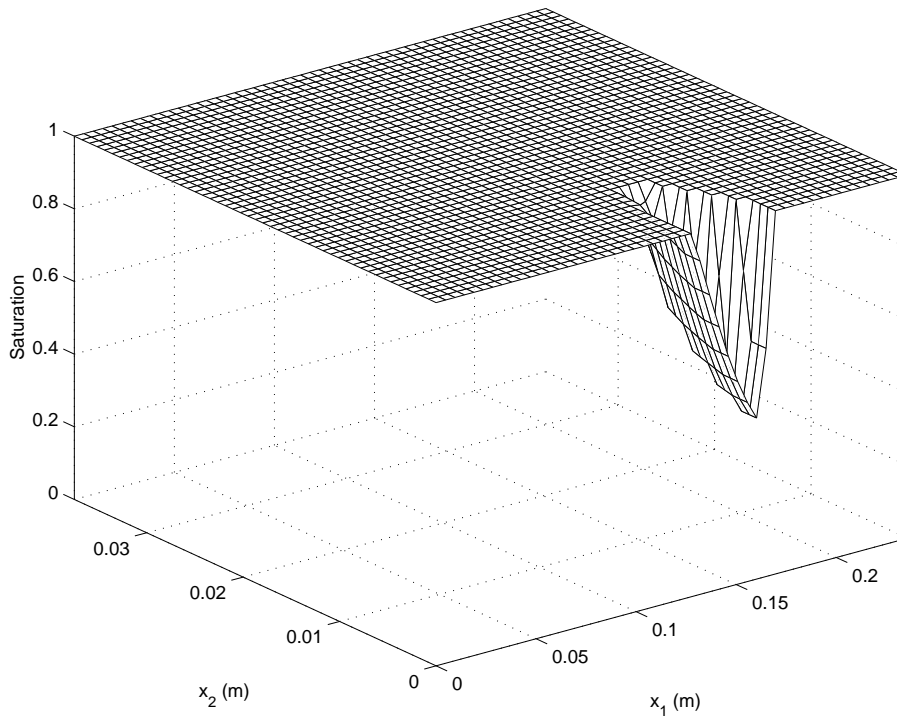

Figure 12: Hydrodynamic homogenized saturation (transverse roughness; case 1<sup>a</sup>)

Supposing that  $p_\varepsilon$  converges strongly to  $p_0$  in  $L^2(\Omega)$  with an order of convergence  $\mathcal{O}(\varepsilon^\alpha)$ , we numerically calculate  $\alpha$ : FIG.13 is obtained so that  $\alpha = 1$ .

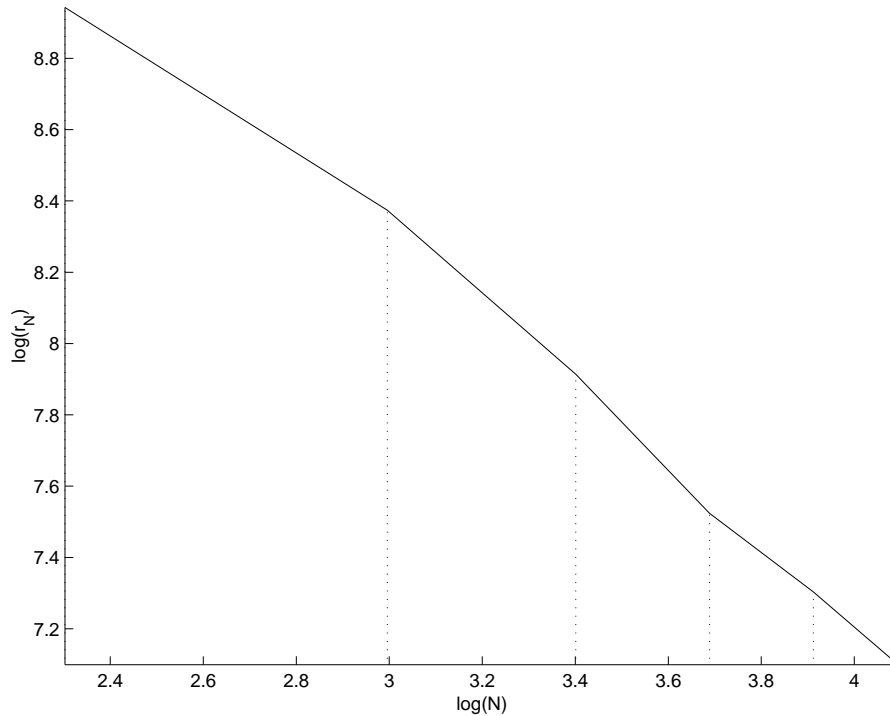

Figure 13: Convergence speed of the pressure (transverse roughness; case 1<sup>b</sup>)

### 3.2.2 Case 2: Longitudinal roughness tests

For this test, we have considered the following physical data: the eccentricity is  $\rho = 0.8$  and the amplitude of the roughness is given by  $\beta/(1 - \rho) = 0.5$ , which is a realistic regime in terms of mechanical applications. The numerical methods parameters are the following ones: a triangular uniform finite element mesh with  $\Delta x_1 = 2\pi/400$ ,  $\Delta x_2 = 1/80$  (so that we have 64000 triangles and 32481 vertices), an artificial time step for the characteristics method  $\Delta t = \Delta x_1$ ; the Bermudez-Moreno parameters are still  $\omega = 1$  and  $\lambda = 1/(2\omega)$ ; the stopping test in all algorithms is equal to  $\delta = 10^{-5}$ .

FIG.16 and 17 represent the cuts at  $x_1 = 0.1060 m$  and  $x_1 = 0.1355 m$  respectively, for the deterministic pressure (for different numbers of roughness patterns  $N_\varepsilon = 2\pi/\varepsilon$ ) and the homogenized pressure.

- FIG.16: the section of the bearing does not contain any cavitation area ( $p > 0$ ) so that the saturation function is constant and equal to 1 (therefore the corresponding figure is omitted). Notice that the section corresponds to the minimum gap (and maximum pressure).
- FIG.17: in this case, the section does contain a cavitated area.

Thus, the figures allow us to observe convergence phenomena for the pressure in both cavitated and non-cavitated areas. Let us notice that, not surprisingly, the convergence of the pressure is better in the longitudinal roughness case, as the influence of the roughness on the pressure is relatively small. As in the transverse roughness tests, we could numerically illustrate the weak convergence of the saturation. Finally, FIG.18 and 19 present the homogenized pressure and saturation in the whole domain.

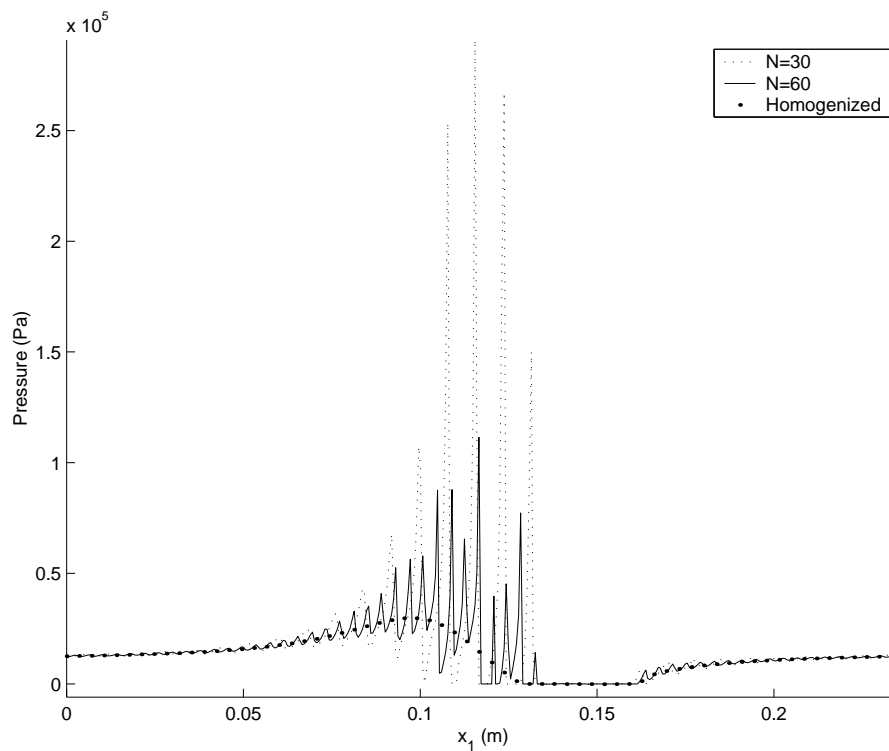

Figure 14: Hydrodynamic pressure at  $x_2 = 0.0032 \text{ m}$  (transverse roughness; case  $1^b$ )

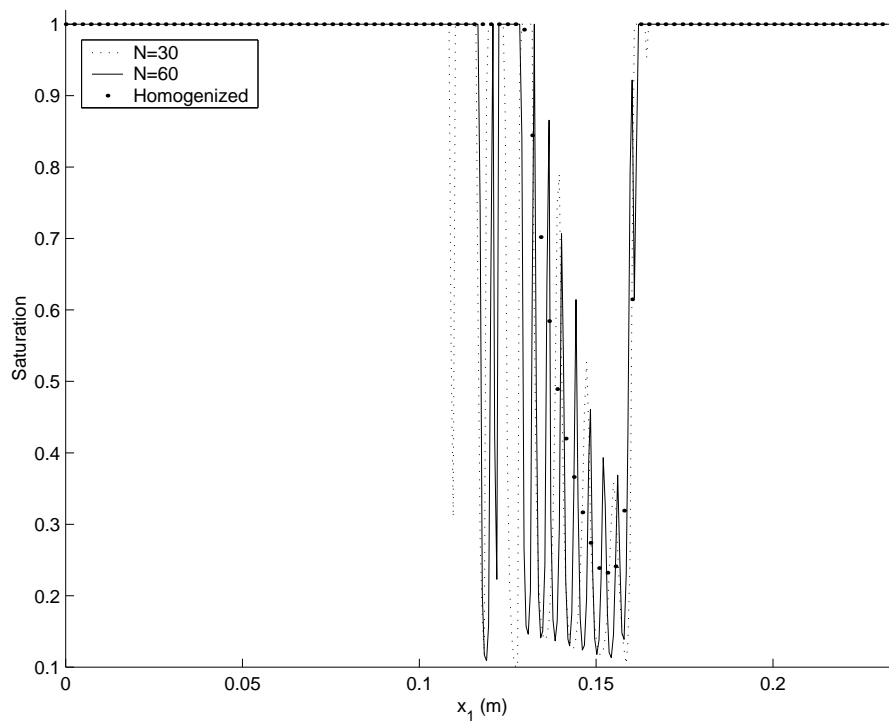

Figure 15: Hydrodynamic saturation at  $x_2 = 0.0032 \text{ m}$  (transverse roughness; case  $1^b$ )

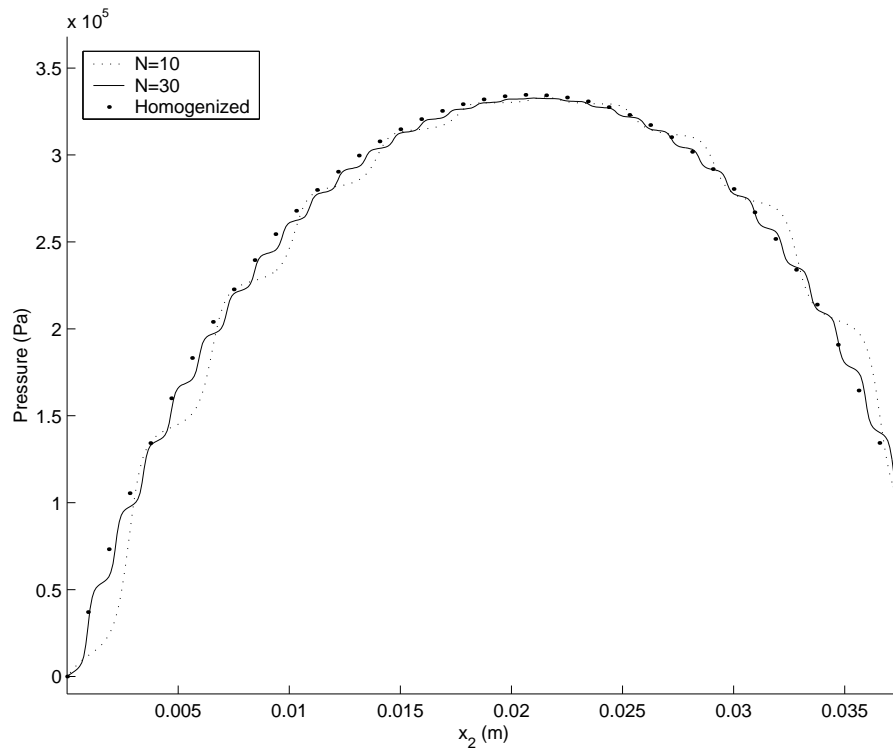

Figure 16: Hydrodynamic pressure at  $x_1 = 0.1060 \text{ m}$  (longitudinal roughness; case 2)

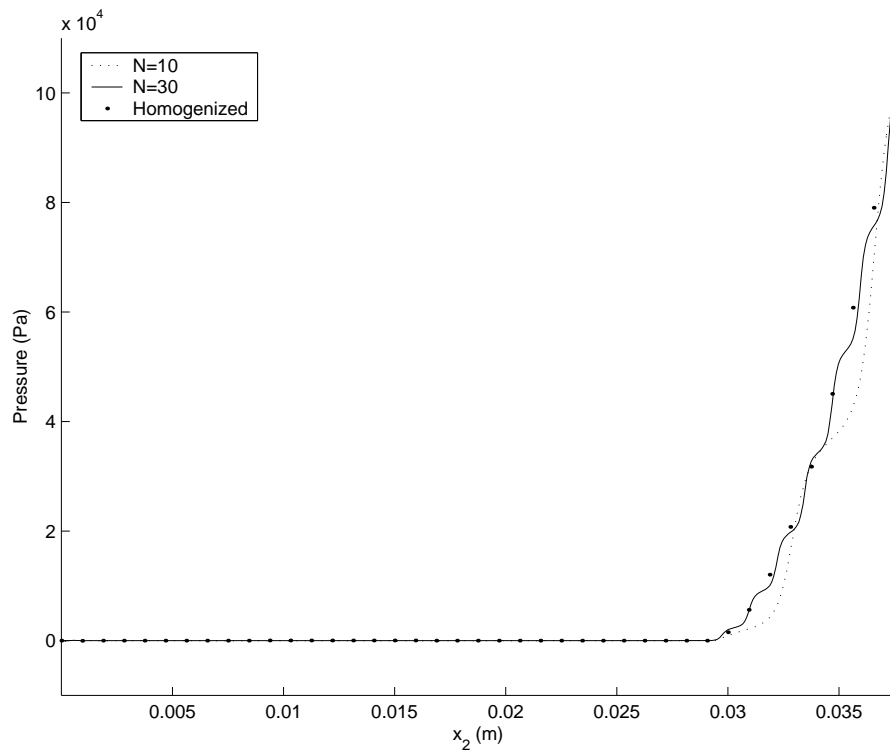

Figure 17: Hydrodynamic pressure at  $x_1 = 0.1355 \text{ m}$  (longitudinal roughness; case 2)

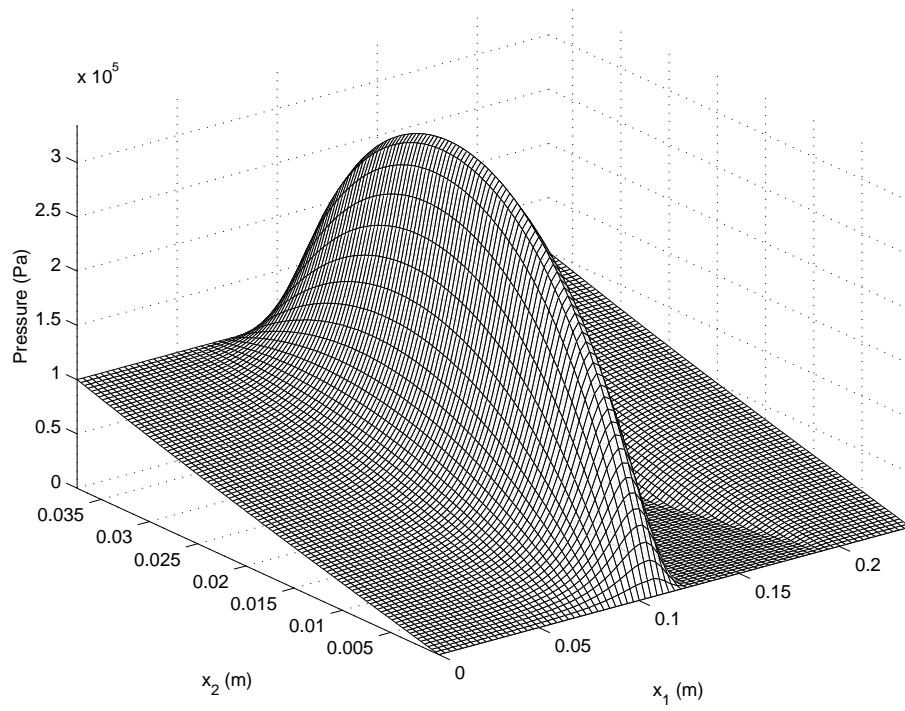

Figure 18: Hydrodynamic homogenized pressure (longitudinal roughness; case 2)

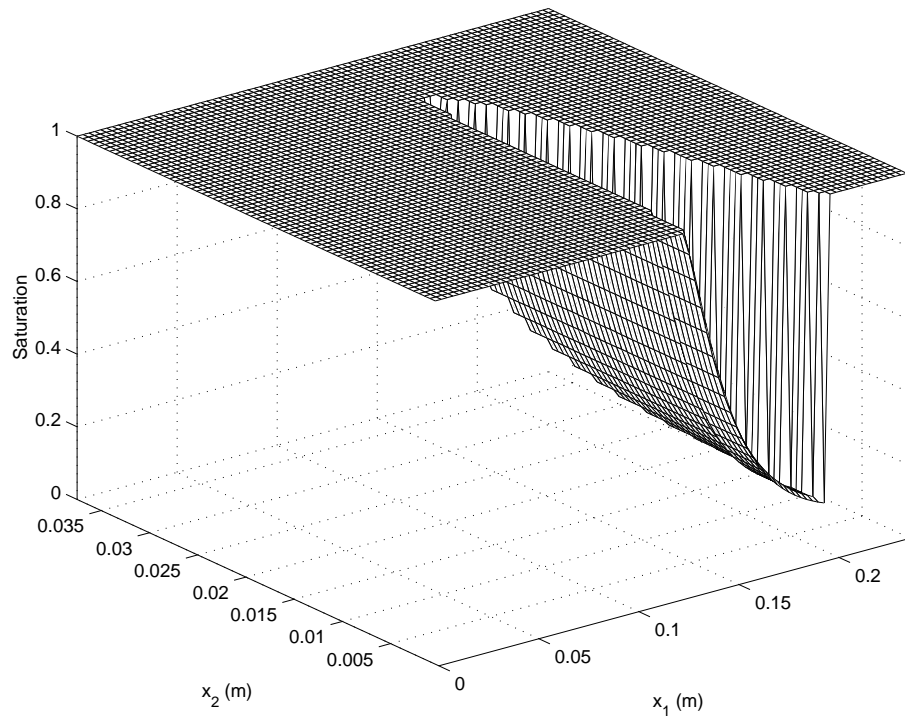

Figure 19: Hydrodynamic homogenized saturation (longitudinal roughness; case 2)

## References

- [1] G. Allaire. Homogenization and two-scale convergence. *SIAM J. Math. Anal.*, 23(6):1482–1518, 1992.
- [2] H. W. Alt. Strömungen durch inhomogene poröse Medien mit freiem Rand. *J. Reine Angew. Math.*, 305:89–115, 1979.
- [3] H. W. Alt. Numerical solution of steady-state porous flow free boundary problems. *Numer. Math.*, 36(1):73–98, 1980/81.
- [4] S. J. Alvarez. Problemas de frontera libre en teoría de lubricación. *Ph. D. Thesis, Universidad Complutense de Madrid, Spain*, 1986.
- [5] S. J. Alvarez and R. Oujja. On the uniqueness of the solution of an evolution free boundary problem in theory of lubrication. *Nonlinear Anal.*, 54(5):845–872, 2003.
- [6] I. Arregui, J. J. Cendán, and C. Vázquez. Mathematical analysis and numerical simulation of a Reynolds-Koiter model for the elastohydrodynamic journal-bearing device. *M2AN Math. Model. Numer. Anal.*, 36(2):325–343, 2002.
- [7] C. Baiocchi. Free boundary problems in fluid flow through porous media and variational inequalities. In *Free boundary problems, Vol. I (Pavia, 1979)*, pages 175–191. Ist. Naz. Alta Mat. Francesco Severi, Rome, 1980.
- [8] C. Baiocchi, V. Comincioli, E. Magenes, and G.A. Pozzi. Free boundary problems in the theory of fluid flow through porous media: existence and uniqueness theorems. *Ann. Mat. Pura Appl. (4)*, 97:1–82, 1973.
- [9] C. Baiocchi and A. Friedman. A filtration problem in a porous medium with variable permeability. *Ann. Mat. Pura Appl. (4)*, 114:377–393, 1977.
- [10] G. Bayada and M. Boukrouche. Mathematical model. Existence and uniqueness of cavitation problems in porous journal bearing. *Nonlinear Anal.*, 20(8):895–920, 1993.
- [11] G. Bayada and M. Chambat. The transition between the Stokes equations and the Reynolds equation: a mathematical proof. *Appl. Math. Optim.*, 14(1):73–93, 1986.
- [12] G. Bayada and M. Chambat. New models in the theory of the hydrodynamic lubrication of rough surfaces. *ASME J. of Tribology*, 110:402–407, 1988.
- [13] G. Bayada and M. Chambat. Homogenization of the Stokes system in a thin film flow with rapidly varying thickness. *RAIRO Modél. Math. Anal. Numér.*, 23(2):205–234, 1989.
- [14] G. Bayada, M. Chambat, and J.-B Faure. Some effects of the boundary roughness in a thin film flow. In *Boundary Control and Boundary Variations, Lecture Notes in Control and Information Science, Vol. 100*, pages 96–115. Springer-Verlag, (1988).
- [15] G. Bayada, M. Chambat, and C. Vázquez. Characteristics method for the formulation and computation of a free boundary cavitation problem. *J. Comput. Appl. Math.*, 98(2):191–212, 1998.
- [16] G. Bayada and J.-B Faure. A double-scale analysis approach of the Reynolds roughness. Comments and application to the journal bearing. *ASME J. of Tribology*, 111:323–330, 1989.

- [17] V. Benci. On a filtration problem through a porous medium. *Ann. Mat. Pura Appl.* (4), 100:191–209, 1974.
- [18] A. Bensoussan, J.-L. Lions, and G. Papanicolaou. *Asymptotic analysis for periodic structures*, volume 5 of *Studies in Mathematics and its Applications*. North-Holland Publishing Co., Amsterdam, 1978.
- [19] A. Bermúdez and J. Durany. La méthode des caractéristiques pour les problèmes de convection-diffusion stationnaires. *RAIRO Modél. Math. Anal. Numér.*, 21(1):7–26, 1987.
- [20] H. Brezis. *Analyse fonctionnelle*. Collection Mathématiques Appliquées pour la Maîtrise. [Collection of Applied Mathematics for the Master’s Degree]. Masson, Paris, 1983. Théorie et applications. [Theory and applications].
- [21] H. Brezis, D. Kinderlehrer, and G. Stampacchia. Sur une nouvelle formulation du problème de l’écoulement à travers une digue. *C. R. Acad. Sci. Paris Sér. A-B*, 287(9):A711–A714, 1978.
- [22] G. Capriz and G. Cimatti. Partial lubrication of full cylindrical bearings. *ASME J. Lubrication Technol.*, 105:84–89, 1983.
- [23] D. Cioranescu, A. Damlamian, and G. Griso. Periodic unfolding and homogenization. *C. R. Math. Acad. Sci. Paris*, 335(1):99–104, 2002.
- [24] J. Coyne and H. G. Elrod. Conditions for the rupture of a lubricating film, Part 1. *ASME J. Lubrication Technol.*, 92:451–456, 1970.
- [25] J. Coyne and H. G. Elrod. Conditions for the rupture of a lubricating film, Part 2. *ASME J. Lubrication Technol.*, 93:156–167, 1971.
- [26] H. Darcy. *Les fontaines publiques de la ville de Dijon*. Dalmont, Paris, first edition, 1856.
- [27] J. Durany, G. García, and C. Vázquez. Numerical simulation of a lubricated Hertzian contact problem under imposed load. *Finite Elem. Anal. Des.*, 38(7):645–658, 2002.
- [28] H. G. Elrod and M. L. Adams. A computer program for cavitation. *Cavitation and related phenomena in lubrication - Proceedings - Mech. Eng. Publ. Ltd*, pages 37–42, 1975.
- [29] D. Gilbarg and N. S. Trudinger. *Elliptic partial differential equations of second order*. Classics in Mathematics. Springer-Verlag, Berlin, 2001. Reprint of the 1998 edition.
- [30] S. H. Harp and R. F. Salant. An average flow model of rough surface lubrication with inter-asperity cavitation. *ASME J. of Tribology*, 123:134–143, 2001.
- [31] D. Lukkassen, G. Nguetseng, and P. Wall. Two-scale convergence. *Int. J. Pure Appl. Math.*, 2(1):35–86, 2002.
- [32] L. D. Marini and P. Pietra. Fixed-point algorithms for stationary flow in porous media. *Comput. Methods Appl. Mech. Engrg.*, 56(1):17–45, 1986.
- [33] F. Murat. Personal communication, 2003.

- [34] G. Nguetseng. A general convergence result for a functional related to the theory of homogenization. *SIAM J. Math. Anal.*, 20(3):608–623, 1989.
- [35] N. Patir and H. S. Cheng. An average flow model for determining effects of three-dimensional roughness on partial hydrodynamic lubrication. *ASME J. Lubrication Technol.*, 100:12–17, 1978.
- [36] N. Patir and H. S. Cheng. Application of average flow model to lubrication between rough sliding surfaces. *ASME J. Lubrication Technol.*, 101:220–230, 1979.
- [37] O. Reynolds. On the theory of lubrication and its application to Mr Beauchamp tower's experiments, including an experimental determination of the viscosity of olive oil [Paper 52]. *Phil. Trans. Roy. Soc.*, Pt. 1, 1886.
- [38] O. Reynolds. On the slipperiness of ice [Paper 67]. *Man. Lit. Phil. Soc., Memoirs and Proceedings*, 43, 1898-9.
- [39] J.-F. Rodrigues. Some remarks on the homogenization of the dam problem. *Manuscripta Math.*, 46(1-3):65–82, 1984.
- [40] F. Shi and R. F. Salant. A mixed soft elastohydrodynamic lubrication model with interasperity cavitation and surface shear deformation. *ASME J. of Tribology*, 122:308–316, 2000.
- [41] J. H. Tripp. Surface roughness effects in hydrodynamic lubrication: the flow factor method. *ASME J. Lubrication Technol.*, 105:458–465, 1983.
- [42] D. E. A. Van Odyck and C. H. Venner. Compressible Stokes flow in thin films. *ASME J. of Tribology*, 125:543–551, 2003.