



HAL
open science

Entanglement of two-mode Gaussian states: characterization and experimental production and manipulation

Julien Laurat, Gaëlle Keller, Jose-Augusto Oliveira-Huguenin, Claude Fabre,
Thomas Coudreau, Alessio Serafini, Gerardo Adesso, Fabrizio Illuminati

► **To cite this version:**

Julien Laurat, Gaëlle Keller, Jose-Augusto Oliveira-Huguenin, Claude Fabre, Thomas Coudreau, et al.. Entanglement of two-mode Gaussian states: characterization and experimental production and manipulation. *Journal of Optics B Quantum and Semiclassical Optics*, 2005, 7, pp.S577. 10.1088/1464-4266/7/12/021 . hal-00005867v2

HAL Id: hal-00005867

<https://hal.science/hal-00005867v2>

Submitted on 22 Nov 2006

HAL is a multi-disciplinary open access archive for the deposit and dissemination of scientific research documents, whether they are published or not. The documents may come from teaching and research institutions in France or abroad, or from public or private research centers.

L'archive ouverte pluridisciplinaire **HAL**, est destinée au dépôt et à la diffusion de documents scientifiques de niveau recherche, publiés ou non, émanant des établissements d'enseignement et de recherche français ou étrangers, des laboratoires publics ou privés.

Entanglement of two-mode Gaussian states: characterization and experimental production and manipulation

**Julien Laurat[†], Gaëlle Keller[†], José Augusto
Oliveira-Huguenin[†], Claude Fabre[†], and
Thomas Coudreau^{†‡§}**

[†] Laboratoire Kastler Brossel, UPMC, Case 74, 4 Place Jussieu, 75252 Paris
cedex 05, France

[‡] Laboratoire Matériaux et Phénomènes Quantiques, Case 7021, Université
Denis Diderot, 2 Place Jussieu, 75251 Paris cedex 05, France

**Alessio Serafini^{‡‡}, Gerardo Adesso[‡], and
Fabrizio Illuminati[‡]**

[‡] Dipartimento di Fisica “E. R. Caianiello”, Università di Salerno;
CNR-Coherentia, Gruppo di Salerno; and INFN Sezione di Napoli-Gruppo
Collegato di Salerno, Via S. Allende, 84081 Baronissi (SA), Italy

^{‡‡} Department of Physics & Astronomy, University College London, Gower
Street, London WC1E 6BT, United Kingdom

Abstract. A powerful theoretical structure has emerged in recent years on
the characterization and quantification of entanglement in continuous-variable
systems. After reviewing this framework, we will illustrate it with an original set-
up based on a type-II OPO with adjustable mode coupling. Experimental results
allow a direct verification of many theoretical predictions and provide a sharp
insight into the general properties of two-mode Gaussian states and entanglement
resource manipulation.

PACS numbers: 03.67.Mn, 42.65.Yj, 42.50.Dv, 42.50.Lc

§ To whom correspondence should be addressed (coudreau@spectro.jussieu.fr)

1. Introduction

Quantum information aims at the treatment and transport of information using the laws of quantum physics. For these goals, continuous variables (CV) of the electromagnetic field have emerged as a powerful tool [1, 2, 3]. In this context, entanglement is an essential resource. The purpose of this paper is to link the very powerful mathematical description of gaussian states based on covariance matrices and the experimental production and manipulation of entanglement.

Experimentally, entanglement can be obtained directly by type-II parametric interaction below the oscillation deamplifying either the vacuum fluctuations as was demonstrated in the seminal experiment by Ou *et al.* [4] (or in recent experiments [5]) or the fluctuations of a weak injected beam [7]. It can also be obtained above the oscillation threshold in a non frequency degenerate configuration [6]. It can also be obtained indirectly by mixing on a beam splitter two independent squeezed beams. The required squeezing can be produced by Kerr effects – using optical fibers [8] or cold atoms in an optical cavity [9] – or by type-I parametric interaction in a cavity [10, 11]. Single-pass type-I interaction in a non-collinear configuration can also generate directly entangled beams as demonstrated recently by Wenger *et al.* in the pulsed regime [12]. All these methods produce a symmetric entangled state enabling dense coding, the teleportation of coherent [13, 11, 14] or squeezed states [15] or entanglement swapping [16, 14]. These experiments generate an entangled state with a covariance matrix in the so-called ‘standard form’ [17, 18], without having to apply any local linear unitary transformations such as beam-splitting or phase-shifts to exploit it optimally in quantum information protocols.

However, it has been recently shown in [20] that, when a birefringent plate is inserted inside the cavity of a type-II optical parametric oscillator, *i.e.* when mode coupling is added, the generated two-mode state remains symmetric but entanglement is not observed on orthogonal quadratures: the state produced is not in the standard form. The entanglement of the two emitted modes in this configuration is not optimal: it is indeed possible by passive “global” operations to select modes that are more entangled. Our original system provides thus a good insight into the quantification and manipulation of the entanglement resources of two-mode Gaussian states. In particular, as just anticipated, it allows to confirm experimentally the theoretical predictions on the entangling capacity of passive optical elements and on the selection of the optimally entangled bosonic modes [21].

The paper is organized as follows: we start by giving a general overview of gaussian states and defining the covariance matrix formalism, focusing in particular on two-mode states. Over the last years, a great deal of attention has been devoted to defining not only criterion of entanglement but also quantification of this entanglement. Section 3 focuses on different such measures which are interpreted in the covariance matrix formalism. Effects of mode coupling on the generated entanglement is then discussed in detail (section 4). The experimental setup used to generate and quantify the entanglement is presented in section 5. In section 6, experimental measures of entanglement are realized and we discuss on the effect of noise of the covariance matrix on the entanglement measures. Finally, we show how optimization of the resource is obtained by a passive operation – namely a polarization adjustment – operated on the two-mode state (section 7).

2. Gaussian states: general overview

A continuous variable (CV) system is described by a Hilbert space $\mathcal{H} = \bigotimes_{i=1}^n \mathcal{H}_i$ resulting from the tensor product of infinite dimensional Fock spaces \mathcal{H}_i 's. Let \hat{a}_i and \hat{a}_i^\dagger be the annihilation and creation operators acting on \mathcal{H}_i (ladder operators), and $\hat{x}_i = (\hat{a}_i + \hat{a}_i^\dagger)$ and $\hat{p}_i = (\hat{a}_i - \hat{a}_i^\dagger)/i$ be the related quadrature phase operators. The corresponding phase space variables will be denoted by x_i and p_i . Let $\hat{X} = (\hat{x}_1, \hat{p}_1, \dots, \hat{x}_n, \hat{p}_n)$ denote the vector of the operators \hat{x}_i and \hat{p}_i . The canonical commutation relations for the \hat{X}_i can be expressed in terms of the symplectic form Ω

$$[\hat{X}_i, \hat{X}_j] = 2i\Omega_{ij},$$

$$\text{with } \Omega \equiv \bigoplus_{i=1}^n \omega, \quad \omega \equiv \begin{pmatrix} 0 & 1 \\ -1 & 0 \end{pmatrix}.$$

The state of a CV system can be equivalently described by a positive trace-class operator (the density matrix ϱ) or by quasi-probability distributions. In the following, we shall adopt the Wigner quasi-probability function $W(R)$ defined, for any density matrix, as the Fourier transform of the symmetrically ordered characteristic function [22]:

$$W(R) \equiv \frac{1}{\pi^{2n}} \int_{\mathbb{R}^{2n}} \text{Tr}[\varrho D_Y] e^{iY^T \Omega R} d^{2n}Y, \quad R \in \mathbb{R}^{2n},$$

where the displacement operators D_Y (describing the effect on the field of a classical driving current) are defined as

$$D_Y = e^{iY^T \Omega \hat{X}}, \quad Y \in \mathbb{R}^{2n}. \quad (1)$$

The $2n$ -dimensional space of definition of the Wigner function, associated to the quadratic form Ω , is referred to as phase space, in analogy with classical Hamiltonian dynamics. In Wigner phase space picture, the tensor product $\mathcal{H} = \bigotimes \mathcal{H}_i$ of the Hilbert spaces \mathcal{H}_i 's of the n modes results in the direct sum $\Gamma = \bigoplus \Gamma_i$ of the phase spaces Γ_i 's.

States with Gaussian characteristic functions and quasi-probability distributions are referred to as Gaussian states. Such states are at the heart of information processing in CV systems [2] and are the subject of our analysis. By definition, a Gaussian state ϱ is completely characterised by the first and second statistical moments of the field operators, which will be denoted, respectively, by the vector of first moments $\bar{X} \equiv (\langle \hat{X}_1 \rangle, \langle \hat{X}_2 \rangle, \dots, \langle \hat{X}_{2n-1} \rangle, \langle \hat{X}_{2n} \rangle)$ and the covariance matrix (CM) Γ of elements

$$\Gamma_{ij} \equiv \frac{1}{2} \langle \hat{X}_i \hat{X}_j + \hat{X}_j \hat{X}_i \rangle - \langle \hat{X}_i \rangle \langle \hat{X}_j \rangle, \quad (2)$$

where, for any observable \hat{o} , the expectation value $\langle \hat{o} \rangle \equiv \text{Tr}(\varrho \hat{o})$. Notice that, according to our definition of the quadrature operators in terms of the ladder operators, the entries of the CM are real numbers. Being the variances and covariances of quantum operators, such entries are obtained by noise variance and noise correlation measurements. They can be expressed as energies by multiplying them by the quantity $\hbar\omega$, where ω is the frequency of the considered mode. In fact, for any n -mode state the quantity $\hbar\omega \text{Tr}(\Gamma/4)$ is just the contribution of the second moments to the average of the "free" Hamiltonian $\sum_{i=1}^n (\hat{a}_i^\dagger \hat{a}_i + 1/2)$.

Coherent states, resulting from the application of displacement operators D_X to the vacuum state $|0\rangle$, are Gaussian states with CM $\Gamma = \mathbb{1}$ and first statistical moments $\bar{X} = X$. First moments can be arbitrarily adjusted by local unitary operations (displacements), which cannot affect any property related to entropy or entanglement. In the present experimental case, the fields are produced by an OPO below the oscillation threshold, and the means are actually zero. Let us note that this can be done without any loss of generality.

The canonical commutation relations and the positivity of the density matrix ρ imply

$$\Gamma + i\Omega \geq 0, \quad (3)$$

meaning that all the eigenvalues of the (hermitian) matrix $\Gamma + i\Omega$ have to be greater or equal than zero. Inequality (3) is the necessary and sufficient constraint the matrix Γ has to fulfill to be a CM corresponding to a physical Gaussian state [23, 24]. Note that the previous condition is necessary for the CM of *any* (generally non Gaussian) state, as it generalises to many modes the Robertson-Schrödinger uncertainty relation, reducing to the familiar Heisenberg principle for pure, uncorrelated states. We mention that such a constraint implies $\Gamma \geq 0$.

A major role in the theoretical and experimental manipulation of Gaussian states is played by unitary operations which preserve the Gaussian character of the states on which they act. Such operations are all those generated by terms of the first and second order in the field operators. So, beside the already discussed displacements, also the unitary operations generated by terms of the second order are Gaussian. As a consequence of the Stone-Von Neumann theorem, any such operation at the Hilbert space level corresponds, in phase space, to a symplectic transformation, *i.e.* to a linear transformation S which preserves the symplectic form Ω , so that $\Omega = S^T \Omega S$, *i.e.* it preserves the commutators between the different operators. Symplectic transformations on a $2n$ -dimensional phase space form the (real) symplectic group, denoted by $Sp_{(2n, \mathbb{R})}$. Such transformations act linearly on first moments and “by congruence” on covariance matrices (*i.e.* so that $\Gamma \mapsto S^T \Gamma S$). One has $\text{Det } S = 1$, $\forall S \in Sp_{(2n, \mathbb{R})}$.

Ideal beam splitters, phase shifters and squeezers are described by symplectic transformations. In fact single and two-mode squeezings occurring, respectively, in degenerate and non degenerate parametric down conversions, are described by the operators

$$U_{ij,r,\varphi} = e^{\frac{1}{2}(\varepsilon \hat{a}_i^\dagger \hat{a}_j^\dagger - \varepsilon^* \hat{a}_i \hat{a}_j)} \quad \text{with } \varepsilon = r e^{i2\varphi}, r \in \mathbb{R}, \varphi \in [0, 2\pi], \quad (4)$$

resulting in single-mode squeezing of mode i for $i = j$. The representation in phase space of the operation $U_{ij,r,\varphi}$ for $i \neq j$ is given by the linear transformation $S_{ij,r,\varphi}$

$$S_{ij,r,\varphi} = \begin{pmatrix} c - hs & 0 & ks & 0 \\ 0 & c + hs & 0 & -ks \\ ks & 0 & c + hs & 0 \\ 0 & -ks & 0 & c - hs \end{pmatrix} \quad \text{for } i \neq j, \quad (5)$$

where $c = \cosh(2r)$, $s = \sinh(2r)$, $h = \cos(2\varphi)$, $k = \sin(2\varphi)$ (r and φ are same as in Eq. (4)) and the matrix is understood to act on the couple of modes i and j . Beam splitters are described by the operators

$$O_{ij,\theta} = e^{\theta \hat{a}_i^\dagger \hat{a}_j - \theta \hat{a}_i \hat{a}_j^\dagger}, \theta \in [0, 2\pi], \quad (6)$$

corresponding to symplectic rotations $R_{ij,\theta}$ in phase space

$$R_{ij,\theta} = \begin{pmatrix} \cos(\theta) & 0 & -\sin(\theta) & 0 \\ 0 & \cos(\theta) & 0 & -\sin(\theta) \\ \sin(\theta) & 0 & \cos(\theta) & 0 \\ 0 & \sin(\theta) & 0 & \cos(\theta) \end{pmatrix} \quad \text{for } i \neq j. \quad (7)$$

The angle θ is defined by Eq. (6) and, again, the matrix is understood to act on the i and j modes. Single-mode symplectic operations are easily retrieved as well, being just combinations of single mode (two dimensional) rotations and of single mode squeezings of the form $\text{diag}(e^r, e^{-r})$ for $r > 0$. Now, symplectic transformations in phase space are generated by exponentiation of matrices written as $J\Omega$, where J is antisymmetric [25]. Such generators can be symmetric or antisymmetric. The operations $R_{ij,\theta}$, generated by antisymmetric operators are orthogonal and, acting by congruence on the CM Γ , preserve the value of $\text{Tr} \Gamma$. Since $\text{Tr} \Gamma$ gives the contribution of the second moments to the average of the Hamiltonian $\bigoplus_i a_i^\dagger a_i$, these transformations are said to be ‘passive’, or ‘energy preserving’ (they belong to the compact subgroup of $Sp_{(2n,\mathbb{R})}$). Instead, operations $S_{ij,r,\varphi}$, generated by symmetric operators, are not orthogonal and do not preserve $\text{Tr} \Gamma$ (they belong to the non compact subgroup of $Sp_{(2n,\mathbb{R})}$). This mathematical difference between squeezers and phase space rotations accounts, in a quite elegant way, for the difference between ‘active’ (*i.e.* energy consuming) and ‘passive’ (*i.e.* energy preserving) optical transformations.

Finally, let us recall that, due to Williamson theorem [26], the CM of a n -mode Gaussian state can always be written as

$$\Gamma = S^T \nu S, \quad (8)$$

where $S \in Sp_{(2n,\mathbb{R})}$ and ν is the CM

$$\nu = \text{diag}(\nu_1, \nu_1, \dots, \nu_n, \nu_n), \quad (9)$$

corresponding to a tensor product of thermal states with diagonal density matrix ϱ^\otimes given by

$$\varrho^\otimes = \bigotimes_i \frac{2}{\nu_i + 1} \sum_{k=0}^{\infty} \left(\frac{\nu_i - 1}{\nu_i + 1} \right)^k |k\rangle_{ii} \langle k|, \quad (10)$$

$|k\rangle_i$ being the k -th number state of the Fock space \mathcal{H}_i . The dual (Hilbert space) formulation of Eq. (8) then reads: $\varrho = U^\dagger \varrho^\otimes U$, for some unitary U .

The quantities ν_i 's form the symplectic spectrum of the CM Γ and can be computed as the eigenvalues of the matrix $|i\Omega\Gamma|$ [27]. Such eigenvalues are in fact invariant under the action of symplectic transformations on the matrix Γ .

The symplectic eigenvalues ν_i encode essential informations on the Gaussian state Γ and provide powerful, simple ways to express its fundamental properties. For instance, in terms of the symplectic eigenvalues ν_i , the uncertainty relation (3) simply reads

$$\nu_i \geq 1. \quad (11)$$

Also the entropic quantities of Gaussian states can be expressed in terms of their symplectic eigenvalues and invariants. Notably, the purity $\text{Tr} \varrho^2$ of a Gaussian state ϱ is simply given by the symplectic invariant $\text{Det} \Gamma = \prod_{i=1}^n \nu_i$, being $\text{Tr} \varrho^2 = (\text{Det} \Gamma)^{-1/2}$ [28].

2.1. Two-mode states

Since this work is focused on two-mode Gaussian states, we briefly review here some of their basic properties. The expression of the two-mode CM Γ in terms of the three 2×2 matrices α , β , γ will be useful

$$\Gamma \equiv \left(\begin{array}{c|c} \alpha & \gamma \\ \hline \gamma^T & \beta \end{array} \right). \quad (12)$$

For any two-mode CM Γ there exist local symplectic operations S_1 and S_2 (each S_j acting on one of the two modes), such that their direct sum $S_l = S_1 \oplus S_2$ (corresponding to the tensor product of local unitary operations) brings Γ to the so called standard form Γ_{sf} [18, 17]

$$S_l^T \Gamma S_l = \Gamma_{sf} \equiv \left(\begin{array}{cc|cc} a & 0 & c_+ & 0 \\ 0 & a & 0 & c_- \\ \hline c_+ & 0 & b & 0 \\ 0 & c_- & 0 & b \end{array} \right). \quad (13)$$

States whose standard form fulfills $a = b$ are said to be symmetric. Let us recall that any pure state is symmetric and fulfills $c_+ = -c_- = \sqrt{a^2 - 1}$. The correlations a , b , c_+ , and c_- are determined by the four local symplectic invariants $\text{Det}\Gamma = (ab - c_+^2)(ab - c_-^2)$, $\text{Det}\alpha = a^2$, $\text{Det}\beta = b^2$, $\text{Det}\gamma = c_+c_-$. Therefore, the standard form corresponding to any CM is unique (up to a common sign flip in c_- and c_+).

For two-mode states, the uncertainty principle Ineq. (3) can be recast as a constraint on the $Sp_{(4,\mathbb{R})}$ invariants $\text{Det}\Gamma$ and $\Delta(\Gamma) = \text{Det}\alpha + \text{Det}\beta + 2\text{Det}\gamma$:

$$\Delta(\Gamma) \leq 1 + \text{Det}\Gamma. \quad (14)$$

The symplectic eigenvalues of a two-mode Gaussian state will be named ν_- and ν_+ , with $\nu_- \leq \nu_+$, with the Heisenberg uncertainty relation reducing to

$$\nu_- \geq 1. \quad (15)$$

A simple expression for the ν_{\pm} can be found in terms of the two $Sp_{(4,\mathbb{R})}$ invariants (invariants under global, two-mode symplectic operations) [29, 30]

$$2\nu_{\pm}^2 = \Delta(\Gamma) \pm \sqrt{\Delta(\Gamma)^2 - 4\text{Det}\Gamma}. \quad (16)$$

A subclass of Gaussian states with a major interest in experimental quantum optics and in the practical realization of CV quantum information protocols is constituted by the nonsymmetric two-mode squeezed thermal states. Let $S_r = S_{12,r,\pi/4}$ be the two mode squeezing operator with real squeezing parameter r , and let $\varrho_{\nu_i}^{\otimes}$ be a tensor product of thermal states with CM $\Gamma_{\nu_{\pm}} = \mathbb{1}_1\nu_- \oplus \mathbb{1}_2\nu_+$, where ν_{\pm} is the symplectic spectrum of the state. A nonsymmetric two-mode squeezed thermal state $\xi_{\nu_i,r}$ is defined as $\xi_{\nu_i,r} = S_r \varrho_{\nu_i}^{\otimes} S_r^{\dagger}$, corresponding to a standard form with

$$\begin{aligned} a &= \nu_- \cosh^2 r + \nu_+ \sinh^2 r, \\ b &= \nu_- \sinh^2 r + \nu_+ \cosh^2 r, \\ c_{\pm} &= \pm \frac{\nu_- + \nu_+}{2} \sinh 2r. \end{aligned} \quad (17)$$

In the symmetric instance (with $\nu_- = \nu_+ = \nu$) these states reduce to two-mode squeezed thermal states. The covariance matrices of these states are symmetric standard forms with

$$a = \nu \cosh 2r, \quad c_{\pm} = \pm \nu \sinh 2r. \quad (18)$$

These are the states which occur in most realistic parametric down conversion processes, like the one which will be discussed later on in the paper. In the pure case, for which $\nu = 1$, one recovers the two-mode squeezed vacuum. Such states encompass all the standard forms associated to pure states: any two-mode Gaussian state can be reduced to a squeezed vacuum by means of unitary local operations.

3. Entanglement of two-mode Gaussian states

This section aims at reviewing the main results on the qualification and quantification of entanglement for Gaussian states of CV systems, which will be exploited in the following.

The positivity of the partially transposed state (PPT criterion) is necessary and sufficient for the separability of two-mode Gaussian states [18] (and, more generally, of all $(1+n)$ -mode Gaussian states under $1 \times n$ -mode bipartitions [31] and of bisymmetric $(m+n)$ -mode Gaussian states under $m \times n$ -mode bipartitions [32]). In general, the partial transposition $\tilde{\rho}$ of a bipartite quantum state ρ is defined as the result of the transposition performed on only one of the two subsystems in some given basis. It can be promptly inferred from the definition of the Wigner function $W(X)$ that the action of partial transposition amounts, in phase space, to a mirror reflection of one of the four canonical variables. In terms of $Sp(2, \mathbb{R}) \oplus Sp(2, \mathbb{R})$ invariants, this reduces to a sign flip in $\text{Det } \gamma$. Therefore the invariant $\Delta(\Gamma)$ is changed into $\tilde{\Delta}(\Gamma) = \Delta(\tilde{\Gamma}) = \text{Det } \alpha + \text{Det } \beta - 2 \text{Det } \gamma$. Now, the symplectic eigenvalues $\tilde{\nu}_{\mp}$ of $\tilde{\Gamma}$ read

$$\tilde{\nu}_{\mp} = \sqrt{\frac{\tilde{\Delta}(\Gamma) \mp \sqrt{\tilde{\Delta}(\Gamma)^2 - 4 \text{Det } \Gamma}}{2}}. \quad (19)$$

The PPT criterion thus reduces to a simple inequality that must be satisfied by the smallest symplectic eigenvalue $\tilde{\nu}_{-}$ of the partially transposed state

$$\tilde{\nu}_{-} \geq 1, \quad (20)$$

which is equivalent to

$$\tilde{\Delta}(\Gamma) \leq \text{Det } \Gamma + 1. \quad (21)$$

The above inequalities imply $\text{Det } \gamma = c_+ c_- < 0$ as a necessary condition for a two-mode Gaussian state to be entangled. Therefore, the quantity $\tilde{\nu}_{-}$ encodes all the qualitative characterization of the entanglement for arbitrary (pure or mixed) two-modes Gaussian states.

Let us now briefly focus on the entanglement qualification of symmetric states, which will be the subject of the experimental investigations presented in the paper. It is immediately apparent that, because $a = b$, the partially transposed CM in standard form $\tilde{\Gamma}$ (obtained by flipping the sign of c_-) is diagonalized by the orthogonal, symplectic transformation $R_{12, \pi/4}$ of Eq. (7), resulting in a diagonal matrix with entries $a \mp |c_{\mp}|$. The symplectic eigenvalues of such a matrix are then easily retrieved by applying local squeezings. In particular, the smallest eigenvalue $\tilde{\nu}_{-}$ is simply given by

$$\tilde{\nu}_{-} = \sqrt{(a - |c_+|)(a - |c_-|)}. \quad (22)$$

Note that also the original standard CM Γ with $a = b$ could be diagonalized (*not symplectically*, since the four diagonal entries are generally all different) by the same

beam splitter transformation $R_{12,\pi/4}$, with the same orthogonal eigenvalues $a_{\mp}|c_{\mp}|$. It is immediate to verify that $\tilde{\nu}_-$ is just given by the geometric average between the two smallest of such orthogonal eigenvalues of Γ . The two quadratures resulting from the previous beam splitter transformation select orthogonal directions in phase space with respect to the original ones, so they will be referred to as ‘orthogonal’ quadratures. Notice that, in the experimental practice, this allows for the determination of the entanglement through the measurement of diagonal entries (noise variances) of the CM after the application of a balanced beam splitter (which embodies the transformation $R_{12,\pi/4}$).

To explore further consequences of this fact, let us briefly recall some theoretical results on the generation of entanglement under passive (energy-preserving) transformations, which will be precious in the following. As shown in Ref. [21], the minimum value for $\tilde{\nu}_-$ (*i.e.* the maximal entanglement) attainable by passive transformations is given by $\tilde{\nu}_-^2 = \lambda_1\lambda_2$, where λ_1 and λ_2 are the two smallest eigenvalues of Γ . Therefore, the entanglement of symmetric states *in standard form* cannot be increased through energy preserving operations, like beam splitter and phase shifters. On the other hand, as it will be carefully discussed in great detail in the next section, the insertion of a birefringent plate in a type-II optical parametric oscillator results in states symmetric but not in standard form. In such a case the entanglement can be optimized by the action of a (passive) phase shifter.

A measure of entanglement which can be computed for general Gaussian states is provided by the negativity \mathcal{N} , first introduced in Refs. [33, 34], later thoroughly discussed and extended in Ref. [29] to CV systems. The negativity of a quantum state ϱ is defined as

$$\mathcal{N}(\varrho) = \frac{\|\tilde{\varrho}\|_1 - 1}{2}, \quad (23)$$

where $\tilde{\varrho}$ is the partially transposed density matrix and $\|\hat{o}\|_1 = \text{Tr}|\hat{o}|$ stands for the trace norm of the hermitian operator \hat{o} . The quantity $\mathcal{N}(\varrho)$ is equal to $|\sum_i \lambda_i|$, the modulus of the sum of the negative eigenvalues of $\tilde{\varrho}$, quantifying the extent to which $\tilde{\varrho}$ fails to be positive. Strictly related to \mathcal{N} is the logarithmic negativity $E_{\mathcal{N}}$, defined as $E_{\mathcal{N}} \equiv \log_2 \|\tilde{\varrho}\|_1$, which constitutes an upper bound to the *distillable entanglement* of the quantum state ϱ . Both the negativity and the logarithmic negativity have been proven to possess the crucial property of being monotone under LOCC (local operations and classical communications) [29, 35].

For any two-mode Gaussian state ϱ the negativity is a simple decreasing function of $\tilde{\nu}_-$, which is thus itself an inverse quantifier of entanglement:

$$\|\tilde{\varrho}\|_1 = \frac{1}{\tilde{\nu}_-} \Rightarrow \mathcal{N}(\varrho) = \max \left[0, \frac{1 - \tilde{\nu}_-}{2\tilde{\nu}_-} \right], \quad (24)$$

$$E_{\mathcal{N}}(\varrho) = \max [0, -\log_2 \tilde{\nu}_-]. \quad (25)$$

This expression quantifies the amount by which PPT inequality (20) is violated. The symplectic eigenvalue $\tilde{\nu}_-$ thus completely qualifies and quantifies the quantum entanglement of a Gaussian state Γ .

For symmetric Gaussian states one can also compute [19] the entanglement of formation E_F [36]. We recall that the entanglement of formation E_F of a quantum state ϱ is defined as

$$E_F(\varrho) = \min_{\{p_i, |\psi_i\rangle\}} \sum_i p_i E(|\psi_i\rangle), \quad (26)$$

where the minimum is taken over all the pure states realizations of ϱ :

$$\varrho = \sum_i p_i |\psi_i\rangle\langle\psi_i| .$$

The quantity E_F satisfies all the requirements of a proper entanglement measure. The asymptotic regularization of the entanglement of formation is equal to the entanglement cost $E_C(\varrho)$, defined as the minimum number of singlets (maximally entangled antisymmetric two-qubit states) which is needed to prepare the state ϱ through local operations and classical communication [37]. In formulæ:

$$E_C(\varrho) = \lim_{n \rightarrow \infty} \frac{E_F(\varrho^{\otimes n})}{n} . \quad (27)$$

The optimal convex decomposition of Eq. (26) can be found for symmetric states and turns out to be Gaussian, allowing for the determination of the entanglement of formation E_F :

$$E_F = \max [0, h(\tilde{\nu}_-)] , \quad (28)$$

with

$$h(x) = \frac{(1+x)^2}{4x} \log_2 \left(\frac{(1+x)^2}{4x} \right) - \frac{(1-x)^2}{4x} \log_2 \left(\frac{(1-x)^2}{4x} \right) .$$

Such a quantity is, again, a decreasing function of $\tilde{\nu}_-$, thus providing a quantification of the entanglement of symmetric states equivalent to the one provided by the logarithmic negativity E_N .

In the nonsymmetric case, an important result is that for any entangled two-mode Gaussian state ϱ , the symplectic eigenvalue $\tilde{\nu}_-$ (and, consequently, the logarithmic negativity) can be estimated with remarkable accuracy by only determining the global purity $\text{Tr } \varrho^2$ of the state, and the two local purities $\text{Tr } \varrho_{1,2}^2$ of each of the two reduced single-mode states $\varrho_i = \text{Tr}_j \varrho$. For the aforementioned class of nonsymmetric thermal squeezed states, the estimate becomes actually an exact quantification, since the logarithmic negativity of these states is a function of the three purities only [38]. These states are indeed the maximally entangled two-mode Gaussian states at fixed global and local purities, and thus they are the states one would like to produce and exploit in any continuous-variable quantum information processing. On the other hand, the symmetric instance, which carries the highest possible entanglement [39] (and which is the experimental product of the present paper), is the one that enables continuous-variable teleportation of an unknown coherent state [13, 11, 14] with a fidelity arbitrarily close to 1 even in the presence of noise (mixedness), provided that the state is squeezed enough (ideally, a unit fidelity requires infinite squeezing). Actually, the fidelity of such an experiment, if the squeezed thermal states employed as shared resource are optimally produced, turns out to be itself a measure of entanglement and provides a direct, operative quantification of the entanglement of formation present in the resource [40].

4. Effects of mode coupling on the entanglement generation

As mentioned in the introduction, entanglement is very often produced by mixing on a beam splitter two squeezed modes. In the general case, the squeezed quadratures

have an arbitrary phase difference. We denote $\theta + \pi/2$ the phase difference between the two squeezed quadratures. The CM of the squeezed modes is then

$$\Gamma_{A_+A_-} = \left(\begin{array}{cc|cc} a & 0 & 0 & 0 \\ 0 & 1/a & 0 & 0 \\ \hline 0 & 0 & b & c \\ 0 & 0 & c & b' \end{array} \right), \quad (29)$$

while the CM of the two modes after the beam-splitter is

$$\Gamma_{A_1A_2} = R_{\pi/4}^T \cdot \Gamma_{A_+A_-} \cdot R_{\pi/4} = \left(\begin{array}{cc|cc} n_1 & k' & k & k' \\ k' & n_2 & k' & -k \\ \hline k & k' & n_1 & k' \\ k' & -k & k' & n_2 \end{array} \right) \quad (30)$$

where

$$\begin{aligned} b &= \frac{\cos^2 \theta}{a} + a \sin^2 \theta, & b' &= a \cos^2 \theta + \frac{\sin^2 \theta}{a}, & c &= \left(a - \frac{1}{a}\right) \sin \theta \cos \theta, \\ n_1 &= \frac{\cos^2 \theta + a^2(\sin^2 \theta + 1)}{2a}, & n_2 &= \frac{a^2 \cos^2 \theta + \sin^2 \theta + 1}{2a}, \\ k &= \left(\frac{1-a^2}{2a}\right) \cos^2 \theta, & k' &= \left(\frac{a^2-1}{2a}\right) \sin \theta \cos \theta. \end{aligned}$$

Let us first note that expression 30 can be brought back to the expression given on fig. 5 of [20] *via* local unitary operations which do not modify the entanglement.

The CM of the squeezed (A_{\pm}) modes gives a good insight into the properties of the two-mode state. One can see that the intermodal blocks are zero, meaning that the two modes are uncorrelated. Consequently, they are the two most squeezed modes of the system (no further passive operation can select more squeezed quadratures). But one can also note that the two diagonal blocks are not diagonal simultaneously. This corresponds to the tilt angle of the squeezed quadrature. In order to maximize the entanglement, the two squeezed quadratures have to be made orthogonal, which can be done by a phase-shift of one mode relative to the other.

It is easy in fact to compute the logarithmic negativity quantifying entanglement between the entangled modes A_1 and A_2 , when the two squeezed quadratures are rotated of $\pi/2 + \theta$. One has $E_{\mathcal{N}}(\Gamma_{A_1A_2}) = -(1/2) \log \tilde{\nu}^2$, with

$$\begin{aligned} \tilde{\nu}^2 &= \left(\frac{1}{4a^2}\right) \left\{ 2(a^4 + 1) \cos^2(\theta) + 4a^2 \sin^2(\theta) \right. \\ &\quad \left. - \sqrt{2}(a^2 - 1) \sqrt{\cos^2(\theta) [a^4 + 6a^2 + (a^2 - 1)^2 \cos(2\theta) + 1]} \right\}. \quad (31) \end{aligned}$$

The symplectic eigenvalue $\tilde{\nu}$ is obviously a periodic function of θ , and it is globally minimized for $\theta = k\pi$, with $k \in \mathbb{Z}$. The entanglement, in other words, is maximized for orthogonal modes in phase space, as already predicted in Ref. [21]. Notice that this results holds for general nonsymmetric states, i.e. also in the case when the two modes A_1 and A_2 possess different individual squeezings. For symmetric states, the logarithmic negativity is depicted as a function of the single-mode squeezing a and the tilt angle θ in figure 1.

In the experiment we will discuss below, the entanglement is produced by a single device, a type-II OPO operated below threshold. When no coupling is present in the

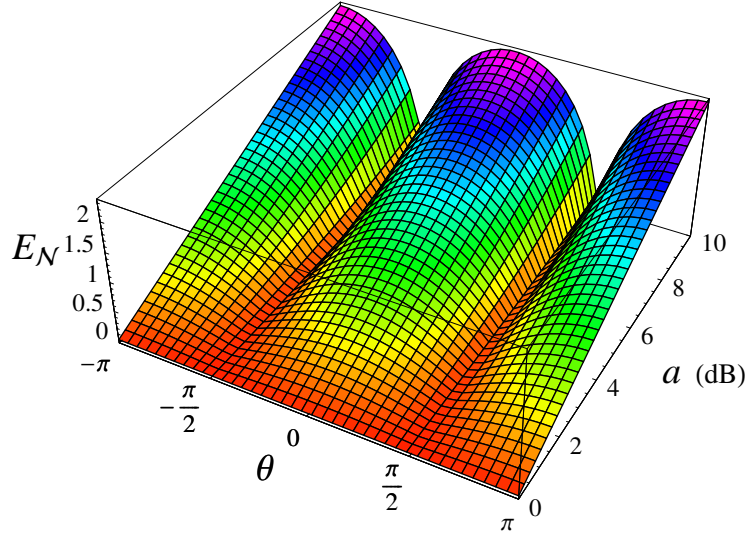

Figure 1. Logarithmic negativity as a function of the single-mode squeezing a and the tilt angle θ between the two non-orthogonal quadratures in presence of mode coupling.

optical cavity, the entangled modes are along the neutral axis of the crystal while the squeezed modes corresponds to the $\pm 45^\circ$ linear polarization basis. However, we have shown theoretically and experimentally in [20] that a coupling can be added *via* a birefringent plate which modifies the quantum properties of this device: the most squeezed quadratures are non-orthogonal with an angle depending on the plate angle. When the plate angle increases, the squeezed (A_-) quadrature rotates of a tilt angle θ and the correlations are degraded. The evolution is depicted on figure 2 through the noise ellipse of the superposition modes.

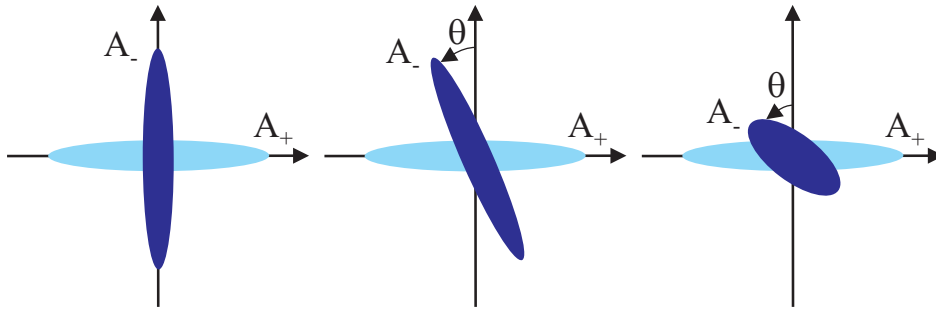

Figure 2. Fresnel representation of the noise ellipse of the $\pm 45^\circ$ rotated modes when the coupling is increased. The noise ellipse of the -45° mode rotates and the noise reduction is degraded when the coupling increases while the $+45^\circ$ rotated mode is not affected.

Eqn. 31 shows that when coupling is present, it is necessary to perform an operation on the two modes in order to optimize the available entanglement. Before

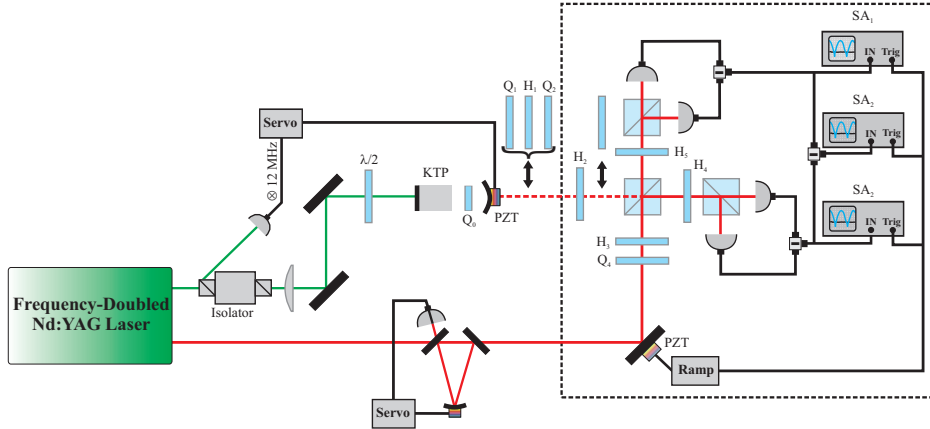

Figure 3. Experimental setup. A continuous-wave frequency-doubled Nd:YAG laser pumps below threshold a type II OPO with a $\lambda/4$ plate inserted inside the cavity (Q_0). The generated two-mode vacuum state is characterized by two simultaneous homodyne detections. The infrared output of the laser is used as local oscillator after filtering by a high-finesse cavity. $SA_{1,2,3}$: spectrum analyzers. $Q_{1,2,3,4}$ and $H_{1,\dots,5}$: respectively quarter and half waveplates. PD Lock: FND-100 photodiode for locking of the OPO. PD Split: split two-element InGaAs photodiode for tilt-locking of the filtering cavity.

developing experimental measures of entanglement and optimization of the available resource in our system, let us detail our experimental setup.

5. Experimental setup and homodyne measurement

The experimental scheme is depicted on figure 3 and relies on a frequency-degenerate type-II OPO below threshold. The system is equivalent to the one of the seminal experiment by Ou *et al.* but a $\lambda/4$ birefringent plate has been inserted inside the optical cavity (Q_0). When this plate is rotated, it results in a linear coupling between the signal and idler modes which induces above threshold a phase locking effect at exact frequency degeneracy [47, 48]. This triply-resonant OPO is pumped below threshold with a continuous frequency-doubled Nd:YAG laser. The input flat mirror is directly coated on one face of the 10mm-long KTP crystal. The reflectivities for the input coupler are 95% for the pump (532nm) and almost 100% for the signal and idler beams (1064nm). The output coupler ($R=38$ mm) is highly reflecting for the pump and its transmission is 5% for the infrared. At exact triple resonance, the oscillation threshold is less than 20 mW. The OPO is actively locked on the pump resonance by the Pound-Drever-Hall technique. The triple resonance is reached by adjustment of both the crystal temperature and the frequency of the pump laser. Under these conditions, the OPO can operate stably during more than one hour without mode-hopping. The birefringent plate Q_0 inserted inside the cavity is exactly $\lambda/4$ at 1064 nm and almost λ at the 532 nm pump wavelength. Very small rotations of this plate around the cavity axis can be operated thanks to a piezoelectric actuator.

Measurements of the quantum properties of arbitrary quadratures of light mode are generally made using homodyne detection [41]. When an intense local oscillator is used, one obtains a photocurrent which is proportional to the quantum noise of

the light in a quadrature defined by the phase-shift between the local oscillator and the beam measured. This photocurrent can be either sent to a spectrum analyzer which calculates the noise power spectrum or numerized for further treatments like tomographic measurements of the Wigner function [43] or selection [44]. As mentioned above, one can also characterize the entanglement by looking at linear combinations of the optical modes as opposed to linear combinations of the photocurrents [17, 18]. The two modes which form the entangled state must be transformed via the beam splitter operation ($R_{\pi/4}$), that is they are mixed on a 50/50 beam splitter or a polarizing beam-splitter preceded by $\lambda/2$ waveplate (H_2) into two modes which will be both squeezed if the original state is entangled.

Homodyne detection allows for a simple and direct measurement of the 2×2 diagonal blocks of the 4×4 CM. In order to measure the 2×2 off-diagonal blocks, linear combinations of the fields can be used as we will show below. In order to characterize simultaneously two modes a single phase reference is needed. To implement this, we have built a simultaneous double homodyne detection (Fig. 3, in box). The difference photocurrents are sent into two spectrum analyzers triggered by the same signal (SA₁ and SA₃). Two birefringent plates (Q_4 , H_3) inserted in the local oscillator path are rotated in order to compensate residual birefringence. A $\lambda/4$ (Q_3) plate can be added on the beam exiting the OPO in order to transform the in-phase detections into in-quadrature ones (making the transformation $(\hat{x}_+, \hat{p}_+, \hat{x}_-, \hat{p}_-) \rightarrow (\hat{x}_+, \hat{p}_+, \hat{p}_+, \hat{x}_+)$). In such a configuration, two states of light with squeezing on orthogonal quadratures give in phase squeezing curves on the spectrum analyzers. This has two goals: firstly, it simplifies the measurements of the phase-shift between the two homodyne detections and secondly it is necessary for the measurement of the off-diagonal blocks of the CM as we will show now.

Let us describe precisely the procedure used to extract the values of the CM from the homodyne detection signals. These signals consist in an arbitrary pair of spectrum analyzer traces which are represented in figure 4. The horizontal axis is the local oscillator (LO) phase which is scanned as a function of time *via* a piezoelectric transducer while the vertical axis gives the noise power relative to the shot noise expressed in decibels (dB).

We make no assumption on the form of the CM which is written in the general case

$$\Gamma = \left(\begin{array}{c|c} \Gamma_+ & C_{\pm} \\ \hline C_{\pm}^T & \Gamma_- \end{array} \right) = \left(\begin{array}{cc|cc} a & b & c & d \\ b & e & f & g \\ \hline c & f & h & i \\ d & g & i & j \end{array} \right)$$

When the LO phase is chosen so that zero corresponds to the long axis of the noise ellipse of the first mode, the CM is written in the form

$$\Gamma = \left(\begin{array}{cc|cc} a' & 0 & c' & d' \\ 0 & e' & f' & g' \\ \hline c' & f' & h' & i' \\ d' & g' & i' & j' \end{array} \right) = \left(\begin{array}{c|c} \Gamma'_+ & C'_{\pm} \\ \hline C'^T_{\pm} & \Gamma'_- \end{array} \right)$$

a' and e' correspond respectively to the maximum and minimum noise levels measured in a linear scale on the spectrum analyzer for the first mode, which we will choose arbitrarily to be A_+ . One can also easily determine h' , i' and j' from the spectrum

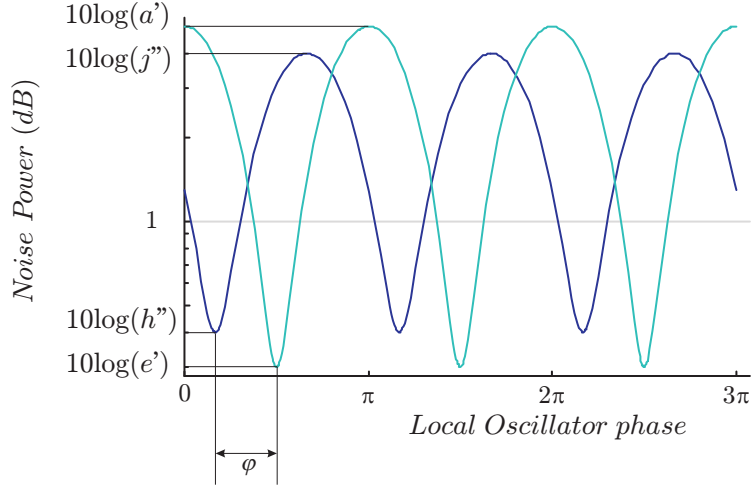

Figure 4. Spectrum analyzer traces as a function of the local oscillator phase.

analyzer traces for A_- : when the LO phase is chosen so that zero corresponds to the long axis of the noise ellipse of the second mode, the CM is written in the form

$$\Gamma''_- = \begin{pmatrix} h'' & 0 \\ 0 & j'' \end{pmatrix}$$

and Γ'_- can be easily deduced from Γ''_- by applying a rotation. The angle of this rotation is given by the phase shift φ between the two traces (see Fig.4). This operation is performed numerically. We have now measured both diagonal blocks.

In order to measure the non-diagonal blocks, one records on an additional spectrum analyzer a third signal, the difference between the two homodyne detection signals (these signals being themselves the difference between their respective photodiodes photocurrents, see Fig. 3). Let us consider the case where the waveplate Q_3 is not present, for a given LO phase ψ_1 , the homodyne detections will give photocurrents which are proportional to the amplitude noise for the A_+ beam, \hat{x}_+ and to the phase noise for the A_- beam, \hat{p}_- . The signal recorded on spectrum analyzer SA₂ is, in this case, proportional $\hat{s} = \hat{x}_+ - \hat{p}_-$ whose variance is

$$\langle \hat{i}^2 \rangle = \langle \hat{x}_+^2 \rangle + \langle \hat{p}_-^2 \rangle - 2\langle \hat{x}_+ \hat{p}_- \rangle = a' + j' - 2d'.$$

a' and j' being already known, it is easy to extract d' from this measurement. For a LO phase $\psi_1 + \pi/2$, one will get using a similar procedure e' , h' and f' . Let us now add the wave plate Q_3 . For a LO phase ψ_1 , one will get a' , h' and c' and for $\psi_1 + \pi/2$ e' , j' and g' thus completing the measurement of the CM.

6. Experimental measures of entanglement by the negativity

As described previously, the entanglement is deduced experimentally from the CM. As all experimental measurements, the measurement of the CM is subject to noise. It is thus critical to evaluate the influence of this noise on the entanglement. A quantitative analysis, relating the errors on the measured CM entries (in the A_{\pm} basis) to the resulting error in the determination of the logarithmic negativity (the latter quantifying entanglement between the corresponding A_1 and A_2 modes) has

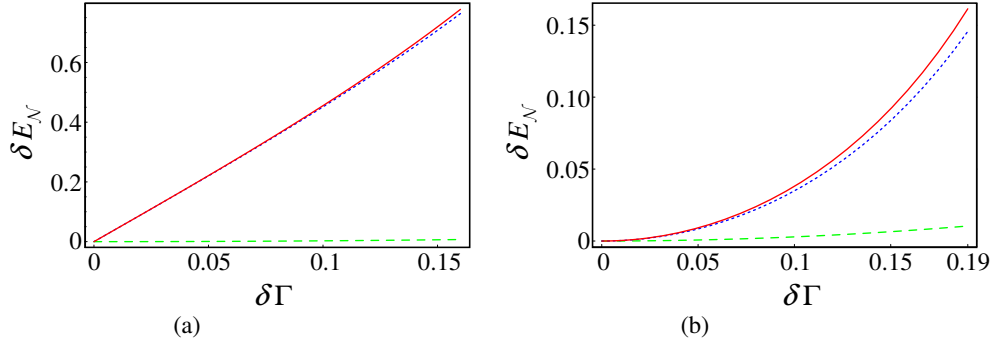

Figure 5. Error $\delta E_{\mathcal{N}}$ on the logarithmic negativity between modes A_1 and A_2 , as a function of the error $\delta\Gamma$ on the entries of the diagonal (a) and off-diagonal (b) 2×2 blocks of the measured CM Γ in the A_{\pm} basis, given by Eq. (32). In plot (a): the solid red curve refers to equal errors (of value $\delta\Gamma$) on the eight entries of the diagonal blocks, the dotted blue curve refers to equal errors on the four diagonal entries of the diagonal blocks while the dashed green curve refers to equal errors on the off-diagonal entries of the diagonal blocks (non standard form entries). At $\delta\Gamma \gtrsim 0.16$ some of the considered states get unphysical. In plot (b): the solid red curve refers to equal errors on the four entries of the off-diagonal block, the dotted blue curve refers to equal errors on the two off-diagonal entries of the off-diagonal block (non standard form entries), while the dashed green curve refers to equal errors on the diagonal entries of the off-diagonal block (standard form entries). At $\delta\Gamma \gtrsim 0.19$ some of the considered states get unphysical.

been carried out and is summarized in Fig. 5 in absence of mode coupling. In general, the determination of the logarithmic negativity is much more sensitive to the errors on the diagonal 2×2 blocks α and β (referring to the reduced states of each mode, see Eq. (12)) of the CM Γ than on the off-diagonal ones (γ , and its transpose γ^T , whose expectations are assumed to be null). Let us remark that the relative stability of the logarithmic negativity with respect to the uncertainties on the off-diagonal block adds to the reliability of our experimental estimates of the entanglement. Notice also that, concerning the diagonal blocks, the errors on diagonal (standard form) entries turn out to affect the precision of the logarithmic negativity more than the errors on off-diagonal (non standard form) entries. This behavior is reversed in the off-diagonal block, for which errors on the off-diagonal (non standard form) entries affect the uncertainty on the entanglement more than errors on the diagonal (standard form) entries.

Experimentally, we have measured the noise on the CM elements to be at best on the order of a few percents of the measured values for the diagonal blocks, corresponding to a fraction of a dB [42]. This is the case for the diagonal blocks which are well-known since they are directly related to the noise measurements of A_+ and A_- . The situation is less favorable for the off-diagonal blocks which require the two homodyne detections to be very precisely in phase since signals from these two detections are used. As a consequence, these blocks show a large experimental noise. As shown on Fig. 5 (b), this may lead in some cases to unphysical CM, yielding for instance a negative determinant and complex values for the logarithmic negativity. Typical values are 0.07 ± 0.05 dB or 1 ± 1 dB for the diagonal elements of the off-diagonal blocks. A phase difference between the two homodyne detections of a few degrees can easily explain such values, especially when the squeezing is large as in our case. In the following, we will set these terms to zero in agreement with the form of

the CM of Eq. 29.

Let us first give an example of entanglement determination from measurements of CM elements, in the absence of mode coupling. Without the plate, the squeezing of the two superposition modes is expected on orthogonal quadratures (the ideal CM is then in the form 29 with $\theta = 0$). Spectrum analyzer traces while scanning the local oscillator phase are shown on figure 6: the rotated modes are squeezed on orthogonal quadratures.

The state is produced directly in the standard form and the CM in the A_{\pm} basis can be extracted from this measurement:

$$\Gamma(\rho = 0) = \left(\begin{array}{cc|cc} 0.33 & 0 & (0) & (0) \\ 0 & 7.94 & (0) & (0) \\ \hline (0) & (0) & 7.94 & 0 \\ (0) & (0) & 0 & 0.33 \end{array} \right) \quad (32)$$

The resulting smallest symplectic eigenvalue is the geometric average of the two minimal diagonal elements : $\tilde{\nu}_- = 0.33$, yielding a logarithmic negativity $E_{\mathcal{N}} = -\log_2(\tilde{\nu}_-) = 1.60$ between the modes A_1 and A_2 .

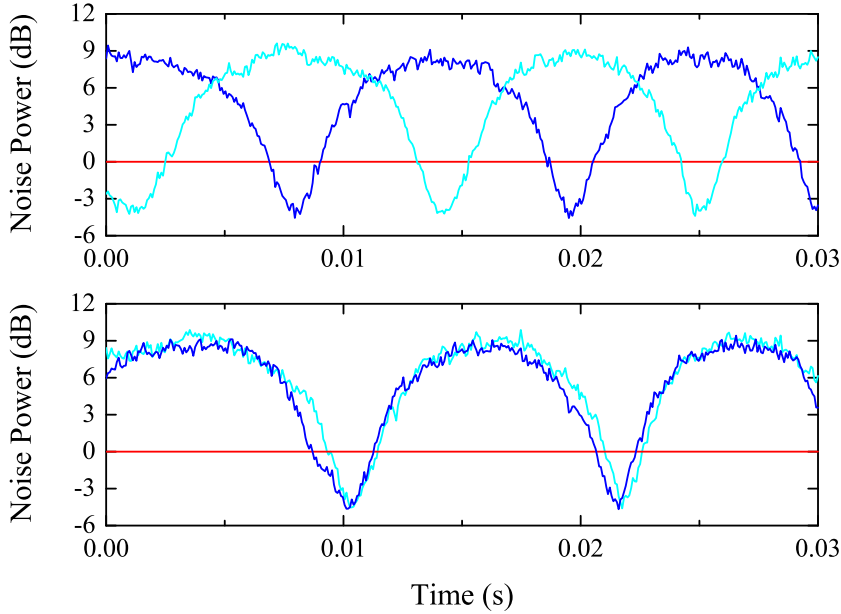

Figure 6. Normalized noise variances at 3.5 MHz of the $\pm 45^\circ$ modes while scanning the local oscillator phase. The first plot corresponds to in-phase homodyne detections and the second one in-quadrature. Squeezing is well observed on orthogonal quadratures. (RBW 100 kHz, VBW 1 kHz)

7. Experimental non standard form and optimization by linear optics

As discussed previously, when the plate angle is increased, the state produced is not anymore in the standard form but rather similar to eqn. 29. Figure 7 gives the normalized noise variances at 3.5 MHz of the rotated modes while scanning the local oscillator phase for an angle of the plate $\rho = 0.3^\circ$. The first plot shows that the

squeezing is not obtained on orthogonal quadratures. The CM takes the following form:

$$\Gamma(\rho = 0.3^\circ) = \left(\begin{array}{cc|cc} 0.4 & 0 & (0) & (0) \\ 0 & 12.59 & (0) & (0) \\ \hline (0) & (0) & 9.54 & -5.28 \\ (0) & (0) & -5.28 & 3.45 \end{array} \right) \quad (33)$$

In this instance, the logarithmic negativity between A_1 and A_2 is much lower than the previous value: $E_{\mathcal{N}} = 1.13$.

As stated above, entanglement can be increased *via* passive operations performed simultaneously on the two modes. Such operations include phase-shifts and beam splitters, which can be readily performed on co-propagating, orthogonally polarized beams [24]. The minimal combination of waveplates can be shown to consist in three waveplates : two $\lambda/4$ waveplates (Q_1 and Q_2 on Fig. 3) and one $\lambda/2$ waveplate (H_1). When using a combination of these three plates, the state can be put back into standard form which will maximize the entanglement. This operation consists in a phase-shift of the rotated modes. Figure 7 gives the normalized noise variances before and after this operation. The CM is changed to:

$$\Gamma(\rho = 0.3^\circ) = \left(\begin{array}{cc|cc} 0.4 & 0 & (0) & (0) \\ 0 & 12.59 & (0) & (0) \\ \hline (0) & (0) & 12.59 & 0 \\ (0) & (0) & 0 & 0.4 \end{array} \right), \quad (34)$$

giving a logarithmic negativity $E_{\mathcal{N}} = 1.32$ between A_1 and A_2 , larger than the value before the operation. It is also the maximal value than can be obtained considering the available entanglement. This value is smaller than the one obtained when the cavity waveplate (Q_0) is not tilted since tilting this waveplate reduces the correlations

Let us remark again that this transformation is non-local in the sense of the EPR argument: it has to be performed before spatially separating the entangled modes for a quantum communication protocol for instance.

8. Conclusion

We have described the powerful tools underlying the description of continuous variables systems in quantum optics. These tools allow for a nice pictorial view of two-mode Gaussian entangled states. Specifically, we have illustrated their properties through the description and manipulation of the entanglement produced experimentally with an original device, a type-II optical parametric oscillator containing a birefringent plate. We have demonstrated the capabilities of this system through entanglement measurements and manipulation of entangled states, showing in particular how entanglement can be maximized using purely passive operations.

We have also studied quantitatively the influence on the entanglement of the noise affecting the measurement of the elements of the CM. We thus showed that the most significant covariances (exhibiting the highest stability against noise) for an accurate entanglement quantification are the diagonal terms of the diagonal single-mode blocks, and the off-diagonal terms of the intermodal off-diagonal block, the latter being the most difficult to measure with high precision. Alternative methods have been devised to tackle this problem [49, 38] based on direct measurements of global and local invariants of the CM. Such techniques have been implemented in the case of

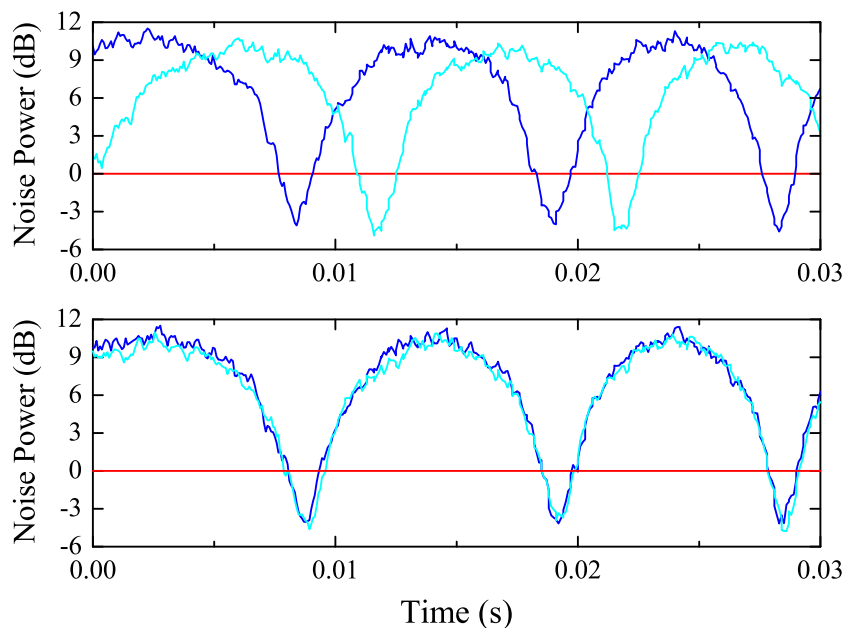

Figure 7. Normalized noise variances at 3.5 MHz of the rotated modes while scanning the local oscillator phase for an angle of the plate of 0.3° , before and after the non-local operation. The homodyne detections are in-quadrature. After this operation, squeezing is observed on orthogonal quadratures.

pulsed beams [50] but no experiment to date has been performed for continuous-wave beams.

Acknowledgement

Laboratoire Kastler-Brossel, of the Ecole Normale Supérieure and the Université Pierre et Marie Curie, is associated with the Centre National de la Recherche Scientifique (UMR 8552). Laboratoire Matériaux et Phénomènes Quantiques, of Université Denis Diderot, is associated with the Centre National de la Recherche Scientifique (UMR 7162). This work has been supported by the European Commission project QUICOV (IST-1999-13071) and ACI Photonique (Ministère de la Recherche et de la Technologie). JAOH acknowledges financial support from CAPES/COFECUB. AS acknowledges financial support from EPSRC through the grant QIP-IRC. GA and FI acknowledge INFN, INFN, and MIUR under national project PRIN-COFIN 2002 for financial support.

References

- [1] Quantum information with Continuous Variables, edited by S. L. Braunstein and A. K. Pati (Kluwer Academic Publishers, Dordrecht, 2003)
- [2] S. L. Braunstein and P. van Loock, *Quantum information with continuous variables*, quant-ph/0410100, and Rev. Mod. Phys. **77** (2005), in press.
- [3] Quantum Information with Continuous Variables of Atoms and Light, N.Cerf, Leuchs and Polzik eds. Imperial College Press in press (2005).

- [4] Z. Y. Ou, S. F. Pereira, H. J. Kimble, and K. C. Peng, *Realization of the Einstein-Podolsky-Rosen paradox for continuous variables*, Phys. Rev. Lett. **68**, 3663 (1992).
- [5] J. Laurat, T. Coudreau, G. Keller, N. Treps, and C. Fabre, *Compact source of Einstein-Podolsky-Rosen entanglement and squeezing at very low noise frequencies*, Phys. Rev. A **70**, 042315 (2004).
- [6] A. S. Villar, L. S. Cruz, K. N. Cassemiro, M. Martinelli, P. Nussenzeig, *Generation of Bright Two-Color Continuous Variable Entanglement*, submitted, quant-ph: 0506139.
- [7] Y. Zhang, H. Wang, X. Li, J. Jing, C. Xie, and K. Peng, *Experimental generation of bright two-mode quadrature squeezed light from a narrow-band nondegenerate optical parametric amplifier*, Phys. Rev. A **62**, 023813 (2000).
- [8] Ch. Silberhorn, P. K. Lam, O. Weiß, F. König, N. Korolkova, and G. Leuchs, *Generation of continuous variable Einstein-Podolsky-Rosen entanglement via the Kerr nonlinearity in an optical fiber*, Phys. Rev. Lett. **86**, 4267 (2001).
- [9] V. Josse, A. Dantan, A. Bramati, M. Pinard, and E. Giacobino, *Continuous Variable Entanglement using Cold Atoms*, Phys. Rev. Lett. **92**, 123601 (2004).
- [10] L.-A. Wu, H. J. Kimble, J. L. Hall, and H. Wu, *Generation of squeezed states by parametric down conversion*, Phys. Rev. Lett. **57**, 2520 (1986).
- [11] W. P. Bowen, N. Treps, B. C. Buchler, R. Schnabel, T. C. Ralph, H. Bachor, T. Symul, and P. K. Lam, *Experimental investigation of continuous-variable quantum teleportation*, Phys. Rev. A **67**, 032302 (2003).
- [12] J. Wenger, A. Ourjoumtsev, R. Tualle-Brouiri, and Ph. Grangier, *Time-resolved homodyne characterization of individual quadrature-entangled pulses*, Eur. Phys. J. D **32**, 391 (2005).
- [13] A. Furusawa, J. L. Sørensen, S. L. Braunstein, C. A. Fuchs, H. J. Kimble, and E. S. Polzik, *Unconditional quantum teleportation*, Science **282**, 706 (1998).
- [14] N. Takei, H. Yonezawa, T. Aoki, and A. Furusawa, *High-Fidelity Teleportation beyond the No-Cloning Limit and Entanglement Swapping for Continuous Variables*, Phys. Rev. Lett. **94**, 220502 (2005).
- [15] N. Takei, T. Aoki, S. Koike, K. Yoshino, K. Wakui, H. Yonezawa, T. Hiraoka, J. Mizuno, M. Takeoka, M. Ban, and A. Furusawa, *Experimental demonstration of quantum teleportation of a squeezed state*, quant-ph/0311056.
- [16] X. Jia, X. Su, Q. Pan, J. Gao, C. Xie, and K. Peng, *Experimental demonstration of unconditional entanglement swapping for continuous variables*, Phys. Rev. Lett. **93**, 250503 (2004).
- [17] Lu-Ming Duan, G. Giedke, J. I. Cirac, and P. Zoller, *Inseparability criterion for continuous variable systems*, Phys. Rev. Lett. **84**, 2722 (2000).
- [18] R. Simon, *Peres-Horodecki separability criterion for continuous variable systems*, Phys. Rev. Lett. **84**, 2726 (2000).
- [19] G. Giedke, M. M. Wolf, O. Krüger, R. F. Werner, and J. I. Cirac, *Entanglement of formation for symmetric Gaussian states*, Phys. Rev. Lett. **91**, 107901 (2003).
- [20] J. Laurat, L. Longchambon, T. Coudreau, G. Keller, N. Treps, and C. Fabre, *Effects of mode coupling on the generation on Einstein-Podolsky-Rosen entanglement in a type-II OPO below threshold*, Phys. Rev. A **71**, 022313 (2005).
- [21] M. M. Wolf, J. Eisert, and M. B. Plenio, *Entangling power of passive optical elements*, Phys. Rev. Lett. **90**, 047904 (2003).
- [22] A. M. Barnett and P. M. Radmore, *Methods in theoretical quantum optics* (Clarendon Press, Oxford, 1997).
- [23] R. Simon, E. C. G. Sudarshan, and N. Mukunda, *Gaussian-Wigner distributions in quantum mechanics and optics*, Phys. Rev. A **36**, 3868 (1987).
- [24] R. Simon, N. Mukunda, and B. Dutta, *Quantum noise matrix for multimode systems: $U(n)$ invariance, squeezing and normal forms*, Phys. Rev. A **49**, 1567 (1994).
- [25] Arvind, B. Dutta, N. Mukunda, and R. Simon, *The Real Symplectic Groups in Quantum Mechanics and Optics*, Pramana **45**, 471 (1995), and quant-ph/9509002.
- [26] J. Williamson, Am. J. Math. **58**, 141 (1936); R. Simon, S. Chaturvedi, and V. Srinivasan, *Congruences and canonical forms for a positive matrix: Application to the Schweinler-Wigner extremum principle*, J. Math. Phys. **40**, 3632 (1999).
- [27] Here $|A|$ stands for the absolute value of the diagonalizable matrix A , to be understood in the usual operatorial sense: if $A = T^{-1}DT$, where D is diagonal and T is a diagonalizing operator, then $|A| = T^{-1}|D|T$, where $|D|$ is just the diagonal matrix with the absolute values of the eigenvalues of A as entries.
- [28] M. G. A. Paris, F. Illuminati, A. Serafini, and S. De Siena, *Purity of Gaussian states: measurement schemes and time evolution in noisy channels*, Phys. Rev. A **68**, 012314 (2003).
- [29] G. Vidal and R. F. Werner, *Computable measure of entanglement*, Phys. Rev. A **65**, 032314

- (2002).
- [30] A. Serafini, F. Illuminati, and S. De Siena, *Symplectic invariants, entropic measures and correlations of Gaussian states*, J. Phys. B: At. Mol. Opt. Phys. **37**, L21 (2004).
 - [31] R. F. Werner and M. M. Wolf, *Bound entangled Gaussian states*, Phys. Rev. Lett. **86**, 3658 (2001).
 - [32] A. Serafini, G. Adesso, and F. Illuminati, *Unitarily localizable entanglement of Gaussian states*, Phys. Rev. A **71**, 032349 (2005).
 - [33] K. Życzkowski, P. Horodecki, A. Sanpera, and M. Lewenstein, *Volume of the set of separable states*, Phys. Rev. A **58**, 883 (1998).
 - [34] J. Eisert, *PhD Thesis*, Universität Potsdam, Potsdam, 2001.
 - [35] M. B. Plenio, *The logarithmic negativity is a full entanglement monotone under measuring LOCC and PPT-operations*, quant-ph/0505071.
 - [36] C. H. Bennett, D. P. DiVincenzo, J. Smolin, and W. K. Wootters, *Mixed-state entanglement and quantum error correction*, Phys. Rev. A **54**, 3824 (1996).
 - [37] P. M. Hayden, M. Horodecki, and B. M. Terhal, *The asymptotic entanglement cost of preparing a quantum state*, J. Phys. A: Math. Gen. **34**, 6891 (2001).
 - [38] G. Adesso, A. Serafini, and F. Illuminati, *Determination of continuous variable entanglement by purity measurements*, Phys. Rev. Lett. **92**, 087901 (2004).
 - [39] G. Adesso, A. Serafini, and F. Illuminati, *Extremal entanglement and mixedness in continuous variable systems*, Phys. Rev. A **70**, 022318 (2004).
 - [40] G. Adesso and F. Illuminati, *Equivalence between entanglement and the optimal fidelity of continuous variable teleportation*, quant-ph/0412125.
 - [41] H. P. Yuen and V. W. S. Chan, *Noise in homodyne and heterodyne detection*, Opt. Lett. **8**, 177 (1983).
 - [42] The noise expressed in decibels (dB) is obtained from the covariance matrix elements via the formula $N_{ij}(dB) = 10 \log_{10}(\Gamma_{ij})$
 - [43] K. Vogel and H. Risken, *Determination of quasiprobability distributions in terms of probability distributions for the rotated quadrature phase*, Phys. Rev. A **40**, 2847 (1989); D. T. Smithey, M. Beck, M. G. Raymer, and A. Faridani, *Measurement of the Wigner distribution and the density matrix of a light mode using optical homodyne tomography: Application to squeezed states and the vacuum*, Phys. Rev. Lett. **70**, 1244 (1993).
 - [44] J. Laurat, T. Coudreau, N. Treps, A. Maître, and C. Fabre, *Conditional preparation of a quantum state in the continuous variable regime: generation of a sub-Poissonian state from twin beams*, Phys. Rev. Lett. **91**, 213601 (2003).
 - [45] A. Heidmann, R. J. Horowicz, S. Reynaud, E. Giacobino, C. Fabre, and G. Camy, *Observation of quantum noise reduction on twin laser beams*, Phys. Rev. Lett. **59**, 2555 (1987).
 - [46] J. Laurat, T. Coudreau, L. Longchambon, and C. Fabre, *Experimental investigation of amplitude and phase quantum correlations in a type II OPO above threshold: from the non-degenerate to the degenerate operation*, Opt. Lett. **30**, 1177 (2005).
 - [47] E.J. Mason, N.C. Wong, *Observation of two distinct phase states in a self-phase-locked type II phase-matched optical parametric oscillator*, Opt. Lett. **23**, 1733 (1998)
 - [48] L. Longchambon, J. Laurat, T. Coudreau, and C. Fabre, *Non-linear and quantum optics of a type II OPO containing a birefringent element, 1. classical operation*, Eur. Phys. Journ. D **30**, 279 (2004).
 - [49] J. Fiurasek, N.J. Cerf, *How to measure squeezing and entanglement of Gaussian states without homodyning*, Phys. Rev. Lett. **93**, 063601 (2004).
 - [50] J. Wenger, J. Fiurasek, R. Tualle-Brouri, N.J. Cerf, P. Grangier, *Pulsed squeezed vacuum characterization without homodyning*, Phys. Rev. A **70**, 053812 (2004).