

Hole redistribution in $\text{Sr}_{14-x}\text{Ca}_x\text{Cu}_{24}\text{O}_{41}$ ($x=0, 12$) spin ladder compounds: ^{63}Cu and ^{17}O NMR study under pressure.

Y. Piskunov^{1,2}, D. Jérôme¹, P. Auban-Senzier¹, P. Wzietek¹ and A. Yakubovsky³

¹ *Laboratoire de Physique des Solides (UMR 8502), Université Paris-Sud, 91405, Orsay, France*

² *Institute of Metal Physics, Ekaterinburg 620219, Russia*

³ *Russian Scientific Center "Kurchatov Institute", Moscow, Russia*

(Dated: May 23, 2005)

We report the results of a ^{63}Cu and ^{17}O NMR study of the nuclear quadrupole interaction tensor, $^{17,63}\nu_{Q,\alpha}$, in the hole doped spin ladder system $\text{Sr}_{14-x}\text{Ca}_x\text{Cu}_{24}\text{O}_{41}$ ($x=0$ and 12) performed under ambient and high pressures. NMR data show that the hole density in the Cu_2O_3 ladder layer grows with temperature, Ca content and an applied pressure. We have derived the hole occupation of Cu 3d and O 2p orbitals at the different ion sites in the Cu_2O_3 ladder as a function of the temperature, Ca substitution and pressure. We also suggest that the most important role of high pressure for the stabilization of a superconducting ground state in Ca-rich two-leg ladders is an increase of the hole concentration in the conducting Cu_2O_3 planes. We have obtained an estimate of 0.10 hole per Cu1 for the hole concentration at low temperature in Ca12 under 32 kbar when this compound undergoes a superconducting transition at 5K. Such a value fits fairly well with the doping phase diagram of cuprate superconductors.

PACS numbers: 74.25.Ha, 74.72.Jt, 76.60.Cq

I. INTRODUCTION

Quasi one dimensional two-leg ladders $\text{Sr}_{14-x}\text{Ca}_x\text{Cu}_{24}\text{O}_{41}$ (Ca_x) have been intensively investigated over the last years due to their fascinating physical properties.^{1,2} Spin ladders $\text{Sr}_{14-x}\text{Ca}_x\text{Cu}_{24}\text{O}_{41}$ have a spin-liquid ground state with a finite spin-gap³ and antiferromagnetic (AF) long-range order^{4,5} coexisting with spin singlets and hole pairs at low T . Furthermore, for samples with the largest Ca concentration, an applied pressure in the range 30-80 kbar stabilizes a superconducting ground state in the ladder planes with a transition temperature passing through a maximum at 10 K around 40 kbar.⁶ Consequently, clarifying the interplay between spin and charge degrees of freedom in doped antiferromagnets is a very important matter for understanding the onset of a superconducting state in spin ladders as well as in high- T_c superconductors. The $\text{Sr}_{14-x}\text{Ca}_x\text{Cu}_{24}\text{O}_{41}$ system is intrinsically hole doped as the stoichiometry implies an average copper valency of 2.25. The redistribution of the preexisting holes among chains and ladders in this composite system, depending on the Ca content, applied pressure and temperature is one of the most important factor which controls the physical properties (in particular superconductivity) of these spin-ladders.

Optical measurements⁷ and the calculation of the Madelung potentials⁸ have shown that for the $x = 0$ compound holes are staying essentially in the chains providing a valency of 2.06 for the ladder Cu sites. Their localization in the chains leads to an insulating behavior. In addition, upon Ca substitution holes are transferred from the chains to the ladders.^{7,9,10} At the same time, the longitudinal conductivity (along the c -axis) increases, leading to quasi one dimensional (Q-1-D) metallic properties.^{6,9} This hole transfer can be caused by the

reduction of the distance between chains and (Sr,Ca) layers,¹¹ which results in an enhancement of the electrostatic potentials in the chains.⁸ Experimentally, however, the precise amount of hole transfer is still under discussion. Osafune *et al.*⁷ have found that the copper valency in the ladders increases from 2.06 up to 2.22 ($n_h = 0.22$ holes per Cu) when x increases from 0 to 11. The systematic measurements of the ^{63}Cu nuclear spin-spin relaxation time T_{2G} (Ref.12) probing the spin correlation length has shown that holes were doped into Cu_2O_3 ladder with a content of $n_h \sim 0.14, 0.22$ and 0.25 holes per Cu for $x=6, 9$ and 11.5 , respectively. Recently, Isobe *et al.*¹³ have investigated the temperature dependence of the crystal structure of $\text{Sr}_{0.4}\text{Ca}_{13.6}\text{Cu}_{24}\text{O}_{41}$ ladders by the Rietveld analysis of neutron diffraction data. Using the bond-valence sum calculation they have estimated the hole concentration in ladder planes as $n_{ladder}(T = 300\text{K}) \sim 0.09$ per Cu1, *i.e.* about three times smaller than what was reported in Ref. 7,12. Moreover, Isobe *et al.*¹³ found that holes located in the ladders tend to move back into the chains at low temperature and that almost all holes were located in the chains near the liquid-He temperature. A similar estimate for the hole content $n_{ladder}(T = 300\text{K}) \sim 0.08$ for the Ca12 compound has been recently deduced from polarization-dependent X-ray absorption data by Nücker *et al.*¹⁴ With a decreasing x , X-ray data indicate only a marginal decrease of $n_{ladder}(T = 300\text{K}) \sim 0.06$ for Ca0. More recently, Thurber *et al.*¹⁵ have reported NMR measurements of the ^{17}O nuclear quadrupole interactions $^{17}\nu_Q$ on the Ca_x ($x=0, 3, 8$). They have related the changes in $^{17}\nu_Q$ to the variation in the effective hole concentration Δn_{ladder} in the Cu_2O_3 ladder layer and have found a decrease of the hole number in Cu_2O_3 going to low temperature for all x values. In addition, they have noticed only a small increase of the hole density of $\Delta n_{ladder} \sim 0.04$ in the

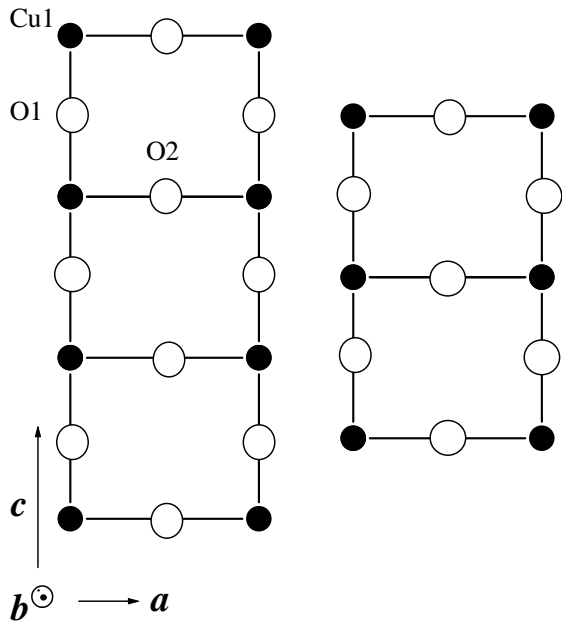

FIG. 1: Schematic representation of the two-leg ladder layer. Closed and open circles are Cu and O atoms, respectively.

ladders layer going from Ca0 to Ca8.

The main effect of Ca doping on the structure of $\text{Sr}_{14-x}\text{Ca}_x\text{Cu}_{24}\text{O}_{41}$ is a reduction of the \mathbf{b} parameter. A similar conclusion is reached by analyzing the effect of hydrostatic pressure.^{16,17} It is the \mathbf{b} parameter which is most sensitive to pressure. Hence, we can expect an increase of the ladder hole density to take place as pressure is increased. This assumption is in agreement with the decrease of the electrical resistivity observed in Refs. 6,9,18 under high pressure. Experimentally, however, quantitative estimates for the hole number transferred into the ladder subsystem under high pressure are still missing.

In order to address such a question the present work attempts to provide an experimental determination of the hole distribution among ladder and chain subsystems as a function of temperature, doping, and pressure. The latter point is crucial since pressure is a prerequisite for the stabilization of superconductivity in $\text{Sr}_{14-x}\text{Ca}_x\text{Cu}_{24}\text{O}_{41}$. We present detailed copper and oxygen NMR studies of the nuclear quadrupole interaction tensor, $^{17,63}\nu_{Q,\alpha}$, in Ca0 and Ca12 single crystal samples at ambient pressure and under the pressure of 32 kbar which can drive the Ca12 system to the situation where superconductivity is stabilized at low temperature. The measurements of $^{17,63}\nu_{Q,\alpha}$ were performed at the different ion sites Cu1, O1 and O2 (see Fig. 1) in the Cu_2O_3 ladder plane. The part concerning the ambient pressure data is consistent with the work of previous workers.¹⁵ Our results emphasize an additional transfer of holes from chains to ladders when pressure is applied in highly Ca-substituted samples.

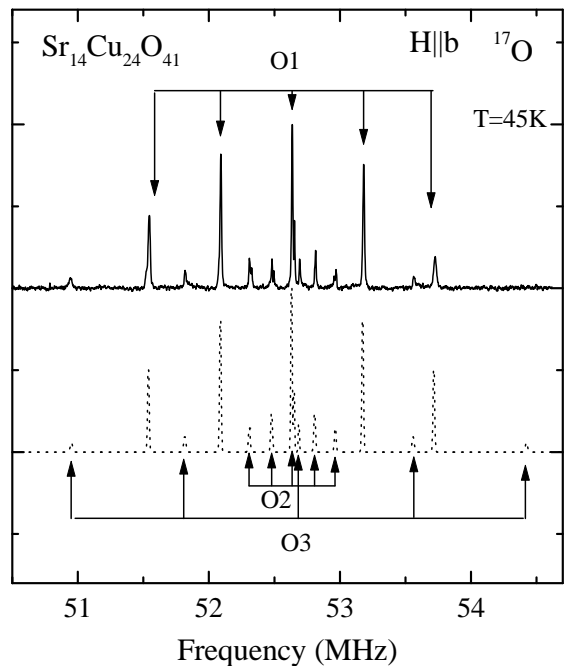

FIG. 2: ^{17}O NMR spectrum in $\text{Sr}_{14}\text{Cu}_{24}\text{O}_{41}$ for $H \parallel \mathbf{b}$ measured at $T=45$ K under ambient pressure (solid line) and the results its simulation (dotted line).

II. EXPERIMENT

NMR studies were carried out on monocrystalline samples of $\text{Sr}_{14}\text{Cu}_{24}\text{O}_{41}$ (Ca0) and $\text{Sr}_2\text{Ca}_{12}\text{Cu}_{24}\text{O}_{41}$ (Ca12) grown by the traveling solvent floating zone method.¹⁹ The samples were enriched with ^{17}O isotope as described elsewhere.²⁰ ^{63}Cu ($I = 3/2$) and ^{17}O ($I = 5/2$) NMR measurements have been performed at a field of 9.3 Tesla with the usual Fourier transform method. The components of the quadrupole interaction tensor, $^{17,63}\nu_{Q,\alpha}$, ($\alpha = a, b, c$) were determined from ^{17}O and ^{63}Cu NMR spectra recorded for the different orientations of the single crystals in the external magnetic field using a simulation software taking into account quadrupolar corrections to the Zeeman frequency in a second order perturbation theory. A typical ^{17}O NMR spectrum obtained for the Ca0 sample at ambient pressure (solid line) and the result of its simulation (dotted line) are displayed in Fig. 2. A precise orientation of the single crystal in the magnetic field along the corresponding axis has been reached through a fine adjustment of the angular position of the pressure cell in the magnetic field. As far as the Cu nucleus is concerned we used the second order shift of the central line as explained below but we also checked on the sample Ca0 that the value of $^{63}\nu_{Q,b}$ thus obtained was in very good agreement with the first order quadrupolar shift derived from the frequency difference between the central and the satellite lines.

NMR frequencies up to the second order quadrupolar

contribution are given by the equations,

$${}^{63}\nu_{(1/2,-1/2),b} = (1 + K_b)\nu_0 + \frac{(\nu_c - \nu_a)^2}{12\nu_0(1 + K_b)} \quad (1)$$

for $H \parallel b$ -axis where K_b , ν_0 , ν_α are the Knight shift, the Larmor frequency in a diamagnetic substance and the quadrupolar tensor components, respectively. For $H \parallel c$ -axis, ${}^{63}\nu_{(1/2,-1/2),c}$ can be expressed as,

$${}^{63}\nu_{(1/2,-1/2),c} = (1 + K_c)\nu_0 + \frac{(3\nu_b - |\nu_c - \nu_a|)^2}{48\nu_0(1 + K_c)} \quad (2)$$

When the magnetic field is aligned along the c -axis, the quadrupolar contribution to the NMR shift is about ten times larger than for the case $H \parallel b$ according to equations 1 and 2 and consequently must be treated on equal footings with the magnetic shifts.

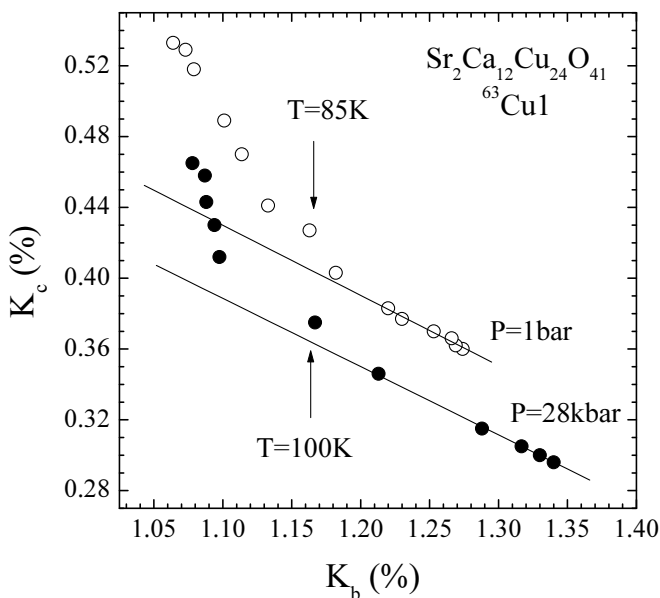

FIG. 3: ${}^{63}\text{Cu1}$ K_c versus K_b plots with temperature as the implicit parameter at $P = 1\text{bar}$ and 28kbar in Ca12 . Straight lines concern the low temperature domain.

We have determined K_c (Eq. (2)) using the values $\nu_a = -4.2\text{MHz}$, $\nu_b = 15.7\text{MHz}$, $\nu_c = -11.5\text{MHz}$ estimated by Magishi *et-al.*¹² for the neighboring composition $\text{Sr}_{2.5}\text{Ca}_{11.5}\text{Cu}_{24}\text{O}_{41}$ at low T . Assuming that $K_{c,s}(P = 1\text{bar}, T = 0) = 0$ in the spin gap regime at ambient pressure we obtain: $K_{c,orb} = K_c(T = 0) = 0.30\%$. Since the spin parts $K_{c,s}$ and $K_{b,s}$ are both proportional to the spin susceptibility $\chi_s(T)$ and given K_{orb} which is temperature independent, the plot K_c versus K_b with temperature as the implicit parameter must be linear,

$$K_c(T) = \frac{A_c(0)}{A_b(0)}K_b(T) + \left[K_{c,orb} - \frac{A_c(0)}{A_b(0)}K_{b,orb} \right], \quad (3)$$

where $A_{c,b}$ are the uniform hyperfine fields.

K_c versus K_b plots at 1bar and 28kbar are shown in figure. 3. As seen in the figure, these plots are not fitted by a straight line over the whole T range. We can ascribe the deviation of the data from straight lines to the temperature dependence of ${}^{63}\nu_Q \equiv |\nu_b|$, namely, it is due to ν_Q increasing with the temperature. Such an increase of ν_Q was reported in several NMR studies of $\text{Sr}_2\text{Ca}_{12}\text{Cu}_{24}\text{O}_{41}$ ^{21,22,23}. In those works, it was indicated that the variation of ν_Q is negligible in the low T regime but becomes quite appreciable above $T \approx 100\text{K}$. Therefore, $K_c(T)$ versus $K_b(T)$ plots were fitted by straight lines in the temperature range below 100K . As a result of the fit, $\frac{A_b(0)}{A_c(0)} = 2.6 \pm 0.1$ is independent of the applied pressure. This finding agrees well with $\frac{A_b(0)}{A_c(0)} = 2.5$ derived in reference¹². Using the ratio $\frac{A_b(0)}{A_c(0)} = 2.6$ and $K_{b,s}$ data *vs* temperature one can derive with a little bit of algebra the T dependence of ν_Q displayed on figure.4

III. RESULTS

Temperature dependences of the b - and c -axis components of the oxygen and copper nuclear quadrupole frequencies, ${}^{17,63}\nu_{Q,b(c)}$, measured for the Cu1 , O1 and O2 ladder sites in Ca0 and Ca12 samples under ambient and high pressures are presented in Figures 4, 5 and 6. For the Ca - free sample, ${}^{17,63}\nu_{Q,\alpha}$, for the Cu1 , O1 , and O2 sites depends on temperature only weakly below 150K , however, increases steeply above 150K . As to the Ca12 compound, $\nu_{Q,\alpha}(\text{Cu1}, \text{O1}, \text{O2})$ shows a dramatic change in the temperature range $\Delta T = 50 \div 200\text{K}$ and a T independent behavior outside this region. As is seen in the

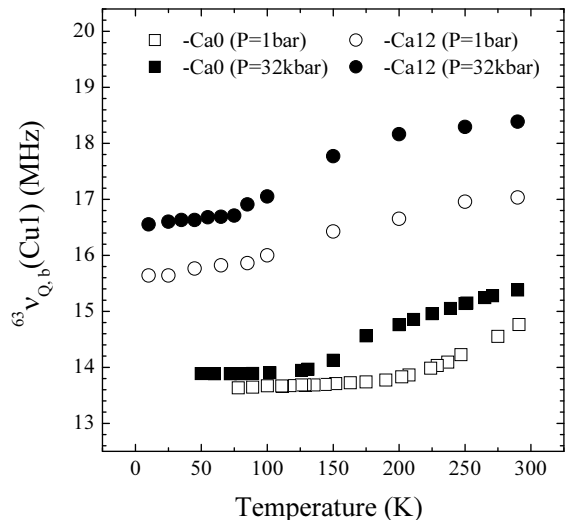

FIG. 4: Temperature dependence of the nuclear quadrupole frequency ${}^{63}\nu_{Q,b}$ at the ladder Cu1 sites in Ca0 and Ca12 single crystals under ambient and high pressures.

figures, the quadrupole frequencies $\nu_{Q,b}(\text{Cu1}, \text{O1}, \text{O2})$ and

$\nu_{Q,c}(O1)$ reveal an increase with both the Ca content and an applied pressure while on the contrary $\nu_{Q,c}(O2)$ is reduced. This fact is indicative of an increase of the asymmetry parameter for EFG tensor at the O2 site, $\eta(O2)$, with increasing Ca content and pressure.

Let us now consider possible reasons for the evolution of $^{17,63}\nu_{Q,\alpha}$ ($\alpha = a, b, c$) varying doping, pressure and temperature.

In a semiempirical approach the quadrupole frequency can be written as a sum of two contributions,²⁴

$$\nu_{Q,\alpha} = (1 - \gamma_\infty)\nu_{l,\alpha} + \nu_{h,\alpha}, \quad (4)$$

where the first term describes the contribution from neighboring ions in a point-charge model enhanced by the Sternheimer antishielding factor γ_∞ and $\nu_{h,\alpha}$ is the term arising from holes in the orbitals of the ion itself. For the Cu 3d and O 2p unfilled shells the hole contributions $^{63}\nu_h$ and $^{17}\nu_h$ can be expressed as follows²⁵

$$^{63}\nu_h = \frac{1}{2} \frac{^{63}Qe^2}{h} \frac{4}{7} \langle r^{-3} \rangle_{3d} n_{3d} = \nu_{3d,0} n_{3d} \quad (5)$$

$$\begin{aligned} ^{17}\nu_{h,\alpha} &= \frac{3}{20} \frac{^{17}Qe^2}{h} \frac{4}{5} \langle r^{-3} \rangle_{2p} \left[n_{2p,\alpha} - \frac{n_{2p,\beta}}{2} - \frac{n_{2p,\gamma}}{2} \right] \\ &= \nu_{2p,0} \left[n_{2p,\alpha} - \frac{n_{2p,\beta}}{2} - \frac{n_{2p,\gamma}}{2} \right] (\alpha, \beta, \gamma = a, b, c). \end{aligned} \quad (6)$$

Here, $\nu_{3d,0}$ ($\nu_{2p,0}$) is the quadrupole frequency when there is one hole in the 3d (2p) orbital and n_{3d} ($n_{2p,\alpha}$) is the hole number in the Cu 3d (O 2p, α) shell. If we take $^{63}Q = -0.211 \times 10^{-24} \text{ cm}^2$, $^{17}Q = -0.026 \times 10^{-24} \text{ cm}^2$, $\langle r^{-3} \rangle_{3d} = 6.04 \text{ a.u.}$,²⁶ $\langle r^{-3} \rangle_{2p} = 3.27 \text{ a.u.}$,^{27,28} we get, $\nu_{3d,0} = 77 \text{ MHz}$, $\nu_{2p,0} = 2.4 \text{ MHz}$.

Quite generally, the lattice contribution to the quadrupole frequency reads,

$$(1 - \gamma_\infty)\nu_{l,\alpha} = (1 - \gamma_\infty) \frac{3}{2I(2I-1)h} Qe \sum_i \frac{\partial^2}{\partial \alpha^2} \frac{e_i}{r_i}, \quad (7)$$

where e_i is the effective charge of the i -th ion and r_i is its position. The sum goes over all crystal sites except for the one considered. In our calculations we used the same values for $^{17}\gamma_\infty = -9$ and $^{63}\gamma_\infty = -20$ as were found in high- T_c cuprates.^{26,29} Then, for α -component of the quadrupole frequency at the oxygen k sites ($k=O1, O2$), $\nu_{Q,\alpha}(k)$ reads (in MHz),

$$\begin{aligned} ^{17}\nu_{Q,\alpha}(k) &= 2.4 \left[n_{2p,\alpha}^k - \frac{n_{2p,\beta}^k}{2} - \frac{n_{2p,\gamma}^k}{2} \right] + \\ &2.80 \times 10^{-9} \sum_j L_\alpha^k(j) e_j. \end{aligned} \quad (8)$$

Here, $L_\alpha^k(j) = \sum_i^{(j)} \frac{\partial^2}{\partial \alpha^2} \frac{1}{r_i}$ is the contribution of the ions located at one of the position j ($j = O1, O2, O3, Cu1, Cu2, Sr/Ca$ sites) to the α -component of the lattice sum

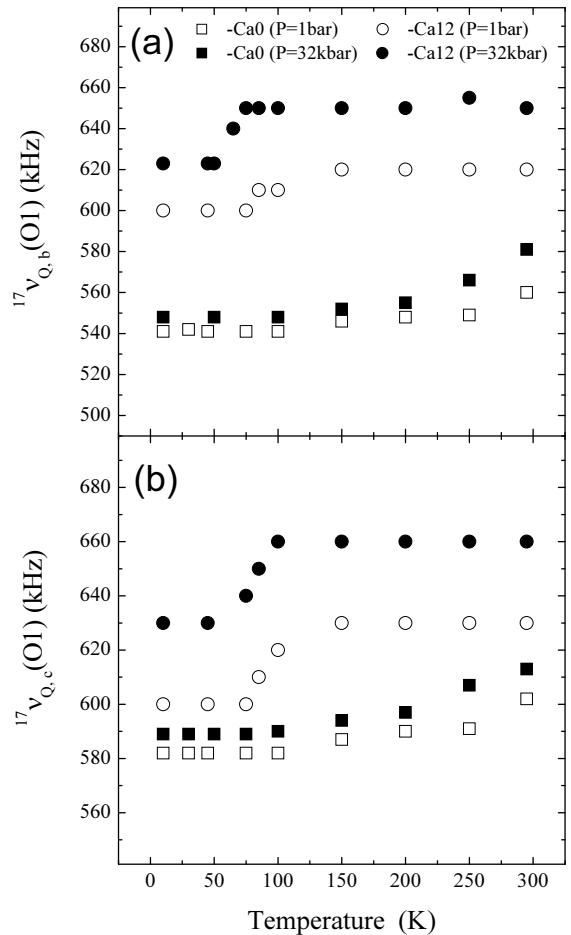

FIG. 5: Temperature dependence of $^{17}\nu_{Q,b(c)}$ at the ladder leg O1 site in Ca0 and Ca12 for H|| **(a) and for H||c (b) under ambient and high pressures.**

for the k -th site ($k=O1, O2$). Cu2 and O3 are copper and oxygen sites in the CuO_2 chains.

Similarly, for $\nu_{Q,\alpha}(\text{Cu1})$ we get,

$$\nu_{Q,\alpha}(\text{Cu1}) = 77n_{3d} + 1.66 \times 10^{-7} \sum_j L_\alpha^{\text{Cu1}}(j) e_j \quad (9)$$

It is important to notice that there is a rather large uncertainty in the lattice contribution (Eq.(7)) to the quadrupole frequency calculated by using a point charge model, which is an oversimplified approximation. Furthermore, the Sternheimer factors $^{63}\gamma_\infty$ and $^{17}\gamma_\infty$ are only crudely determined in the ladders. This uncertainty conveys an important uncertainty for the actual determination of the absolute hole concentration in the ladder Cu_2O_3 layers. Fortunately, the change in the lattice contribution caused by a variation of the temperature, Ca doping and pressure are negligible. Hence, the modification of the quadrupole frequency $\Delta\nu_{Q,\alpha} = (1 - \gamma_\infty)\Delta\nu_{l,\alpha} + \Delta\nu_{h,\alpha}$ observed in the experiment is dominated by the second term $\Delta\nu_{h,\alpha}$ in Eq. (4). In this case, the uncertainty in the lattice contribution $(1 - \gamma_\infty)\Delta\nu_{l,\alpha}$

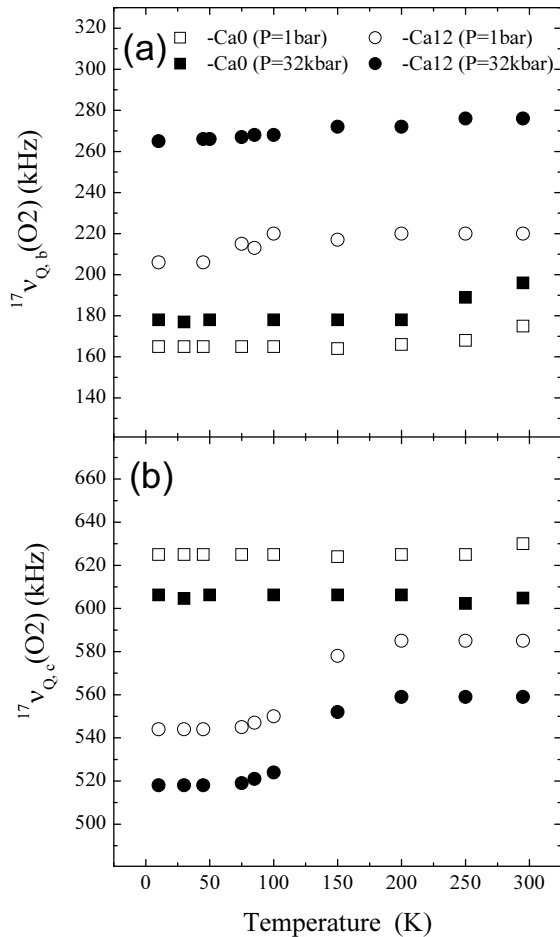

FIG. 6: Temperature dependence of $^{17}\nu_{Q,b(c)}$ at the ladder rung O2 site in Ca0 and Ca12 for $H||b$ (a) and for $H||c$ (b) under ambient and high pressures.

can be neglected since it is a negligible contribution altogether.

The change of quadrupole frequencies $^{17}\nu_{Q,\alpha}$ and $^{63}\nu_{Q,\alpha}$ originating from the hole transfer between chains and ladders can be expressed as follows,

$$\Delta\nu_{Q,\alpha}(k) = 2.4 \left[\Delta n_{2p,\alpha}^k - \frac{\Delta n_{2p,\beta}^k}{2} - \frac{\Delta n_{2p,\gamma}^k}{2} \right] + 2.8 \times 10^{-9} \sum_j L_\alpha^k(j) \Delta n_j + 2.8 \times 10^{-9} \sum_j \Delta L_\alpha^k(j) e_j \quad (10)$$

$$\Delta\nu_{Q,\alpha}(Cu1) = 77\Delta n_{3d} + 1.66 \times 10^{-7} \sum_j L_\alpha^{Cu1}(j) \Delta n_j + 1.66 \times 10^{-7} \sum_j \Delta L_\alpha^{Cu1}(j) e_j, \quad (11)$$

where Δn_{3d} ($\Delta n_{2p,\alpha}^k$) is the variation of the hole number in the Cu 3d (O 2p, α) orbitals and Δn_j is the change of the hole density in the entire O 2p (or Cu 3d) orbital of the ion at the site j . The third term in Eqs. (10) and

(11) takes into account a change of the lattice contribution due to a variation of lattice parameters as a function of temperature, pressure and doping. These small corrections have been calculated for each cases of the ν_Q variation using the results of Refs. 16,17. Next, we have assumed that the holes occupy only the O $2p_\sigma$ orbitals, *i. e.* $n_{2p,b}^k = 0$. Hence,

$$\Delta n(O1(O2)) = \Delta n_{2p,a}(O1(O2)) + \Delta n_{2p,c}(O1(O2)). \quad (12)$$

In addition we have assumed that the holes transferred into the ladders are removed evenly from all atoms of the chains, *i. e.* $\Delta n(O3) = \Delta n(Cu2) \equiv \Delta n_{chain}$, leading to,

$$\Delta n_{chain} = \frac{14}{30} \Delta n(Cu1) + \frac{14}{30} \Delta n(O1) + \frac{7}{30} \Delta n(O2). \quad (13)$$

This latter assumption has practically no effect on the final result. For instance, the result of our calculations is hardly modified if we assume that all holes in the chains are located either in oxygen O 2p or copper Cu 3d orbitals. We have also ignored any effect of covalent bonding between copper and ligand oxygens. Since the transferred hyperfine fields at the O1 and O2 sites are not affected by pressure, doping and temperature²⁰ a variation of ν_Q due to the change of covalent effects exceeding 1-2 % change in ν_Q seems very unlikely. The solution of the system of equations Eqs. (10) - (13) allows us to derive the change in the hole concentration, Δn , for each orbitals.

The hole distribution in Ca0 and Ca12 ladder compounds under ambient and high pressures is summarized in Figs. 7 and 8. Fig. 7(a) shows for compositions Ca0 and Ca12 at ambient and high pressures the temperature dependences of the total hole number in the ladders (counted per Cu1) which are transferred from the CuO_2 chains (left vertical axis). This is the only quantity our measurements can determine accurately. In Fig. 7(a) the number of holes Δn_{ladder} transferred into the ladder plane of $Sr_{14}Cu_{24}O_{41}$ was assumed arbitrarily to be zero at low T . The overall tendency for the hole density in the ladders is a decrease at low temperature. Such a decrease can happen for the following reason: the backtransfer of holes from ladders to chains. In this respect, we could ascribe the temperature of $\sim 200K$ below which on fig.6a $^{17}\nu_{Q,b}(O2)$ becomes temperature independent to the onset of a CDW state³⁰ (or a hole crystallization³¹) in the ladders of Ca0. However, such an effect is not so clearly observed in the hole number on the Cu1 sites. In addition we can rule out such an interpretation for the sudden drop of the hole number in Ca12 around 75K since for this compound the CDW ground state is no longer stable at low temperature³². The backtransfer of charges from the ladders to the chains as temperature is lowered, when the distance between the chains and the ladders is shortened seems to contradict the fact that a shrinkage of the intersheet CuO_2 - Cu_2O_3 distance leads to a hole transfer towards the ladders. This discrepancy has been recently resolved by Isobe *et al.*¹³ These authors have

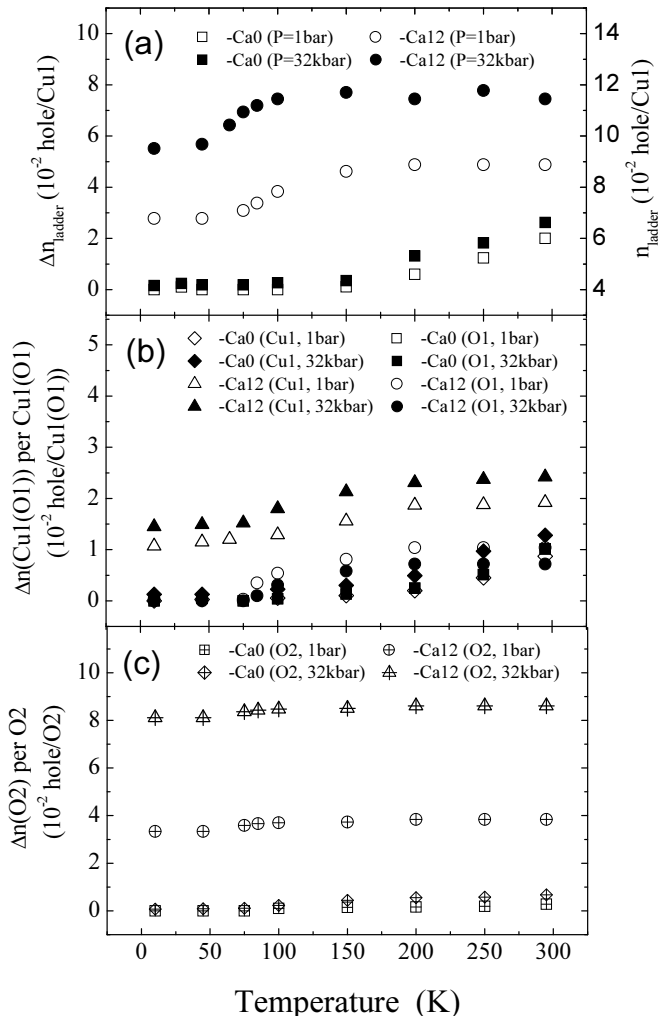

FIG. 7: The hole distribution in Ca0 and Ca12 ladders under ambient and high pressures. (a) T dependence of the hole number per ladder Cu in the Cu_2O_3 ladder transferred from the CuO_2 chains (left vertical axis) and of the total hole concentration after calibration with the NEXAFS data, *see text* (right vertical axis). The distribution of transferred holes among the Cu1, O1 (b) and O2 (c) sites.

shown that it is the minimum O3-Cu1 distance of the modulated structure which governs the hole density in the ladders. Moreover, in spite of the average O3-Cu1 distance becoming shorter at low temperature the minimum does expand. This expansion leads in turn to a reverse hole transfer from ladders to chains.

Using the bond-valence sum calculation, Isobe *et al.*¹³ have obtained that the ladder layer of the Ca13.6 compound contains 1.3 holes per formula unit (*f.u.*) (*i.e.* 0.092 hole per Cu1) at room temperature. In addition, according to this calculation, as the temperature is lowered down to 5 K nearly all holes (~ 1 hole per *f.u.* or 0.07 hole per Cu1) move back to the chains. We note that our results give for Ca12 a much smaller fraction (0.28 holes per *f.u.* or 0.02 hole per Cu1) of the holes moving

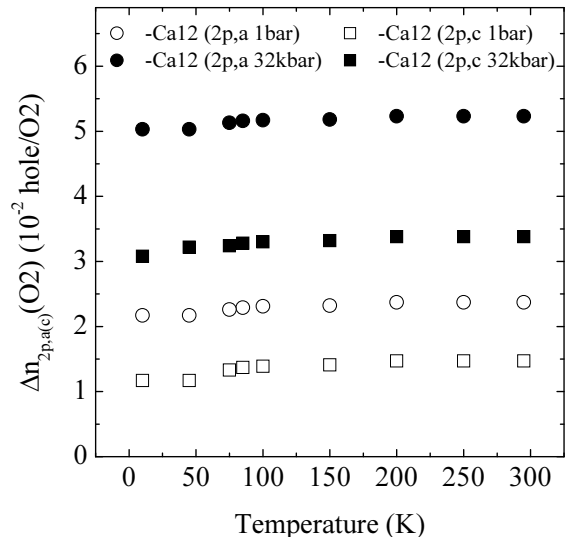

FIG. 8: The distribution of holes located in the 2p orbitals of the oxygen rung site O2 in Ca12 between the 2p,a and 2p,c orbitals.

back into the chains with decreasing temperature. Furthermore, since we only see in the NMR/NQR spectrum the contribution from evenly distributed holes³³, our results indicate that a rather substantial number of holes in Ca12 is remaining on the ladders (possibly delocalized) even down to the lowest temperature. Supporting the possibility that not all holes in the Ca-rich samples are backtransferred from the ladders to the chains at low T is the observation of an antiferromagnetic long-range ordering taking place in the chains of Ca-rich ($x \geq 10$) spin ladders. In the case when six holes per *f.u.* are located in chains, spin-singlet dimers form and antiferromagnetic long-range order does not take place in chains. It is the situation which prevails in Ca-poor compounds with $x < 10$ (Ref. 4). The **presence** of AF order in the chains of the Ca-rich ladders can serve as an indication that the hole number in the chains is less than 6 holes per *f.u.* In that event, "lone" spins and/or "spin-trimers" can form in the chains inducing staggered spin modulations on the remaining spin singlets and AF long-range order in the spin liquid state is established.

IV. DISCUSSION

We have obtained that an increase of the Ca content up to 12 atoms per *f.u.* leads to only a small increase of the hole density in the ladder layer (~ 0.03 hole/Cu1). This value is much smaller than the 0.16 hole/Cu1 found in optical conductivity measurements of Osafune *et al.* for Ca12⁷ but is quite close to the value 0.02 hole/Cu1 derived by in NEXAFS measurements of Nücker *et al.*¹⁴ Interestingly, although the results of Nücker *et al.* and those of Osafune *et al.* relative to the hole number in Cu_2O_3 planes of Ca-rich samples are quite differ-

ent both investigations report the same absolute value $n_{ladder}(300K) \approx 0.06$ hole/Cu1 for the Ca0 compound at room temperature. Consequently, if the hole density in the ladder of Ca0 is really 0.06 holes per Cu1 at room temperature then our results imply that 0.04 hole/Cu1 still persist in the ladder plane of the Ca-free sample at low T . Hence, it is necessary to add 0.04 hole/Cu1 to the amount Δn_{ladder} of holes transferred to the ladders, see fig. 7(a) (left axis), in order to obtain the total hole number, n_{ladder} , located in ladder layers as shown on the right axis of the figure. Then, $n_{ladder}(\text{Ca12}, 300K)$ becomes 0.09 and 0.12 hole/Cu1 at 1 bar and 32 kbar respectively.

At this stage it is interesting to compare our findings for the amount of holes sitting on the ladders in Ca0 with the predictions derived from an *ab initio* calculation by Gellé and Lepetit.³⁴ Following their calculation, the number of holes on the ladders should be much smaller than 1 per *f.u.* in order to lead to a localization of magnetic electrons in agreement with the experimental observation of dimeric units separated by Zhang-Rice singlets. According to fig. 7(a) our experiment gives 0.04 per Cu1 or (0.56 holes per *f.u.*) on the ladders at low temperature. As far as the Ca12 compound is concerned, our experiment gives under ambient pressure a number of 1 hole per *f.u.* transferred into the ladders at low temperature. This figure compares fairly well with the *ab-initio* calculation made for the Ca13.6 system³⁴ predicting a small hole transfer in-between 1 and 2 per *f.u.* in order to explain the existence of an antiferromagnetic ground state at low temperature in the heavily Ca-substituted samples.

An other important result of our study is the observation of an additional increase of n_{ladder} in the ladder layer of the Ca-rich compound under high pressure. The amount of increase is comparable to what is obtained at ambient pressure going from Ca0 to Ca12. It is apparent, therefore, that the important role of high pressure in achieving the conditions for the stabilization of superconductivity in Ca12 is an increase of the hole doping of the conducting Cu_2O_3 planes. On the other hand, high pressure leads to only a slight transfer of holes from chains to ladders in Ca-free compound Ca0. Note, however, that the $\Delta n_{ladder}(\text{Ca0}, 32 \text{ kbar}, 300K) \simeq 0.0262$ hole/Cu1, obtained in our experiments, is quite close to the $\Delta n_{ladder}(\text{Ca3}, 1 \text{ bar}, 300K) \simeq 0.0270$ hole/Cu1 reported by Thurber *et al.*¹⁵ It is well known that the main effect of Ca doping and of a hydrostatic pressure on the structure of $\text{Sr}_{14-x}\text{Ca}_x\text{Cu}_{24}\text{O}_{41}$ is a reduction of the \mathbf{b} parameter.^{11,16,18} The contraction of lattice parameters induced by a pressure of 30 kbar corresponds to a substitution of three Sr by three Ca, *i. e.* $\mathbf{b}(x = 0, P = 30\text{kbar}) \approx \mathbf{b}(x = 3, P = 1\text{bar})$.¹⁶ Thus, the equality between $\Delta n_{ladder}(\text{Ca0}, 32 \text{ kbar})$ and $\Delta n_{ladder}(\text{Ca3}, 1 \text{ bar})$ suggests that the transfer of holes from chains to ladders under pressure and upon Ca doping is caused, at least for the Ca-poor compounds, by the same reason namely, a shrinkage of the intersheet

$\text{CuO}_2\text{-Cu}_2\text{O}_3$ distance.

The hole distribution among Cu1, O1 and O2 sites of the ladders as a function of temperature at different pressure and Ca content is presented in Figs. 7(b) and 7(c). These figures show that the holes transferred from the chains to the ladders with increasing temperature sit mainly on the O1 and Cu1 sites. Ca substitution leads to the transfer of holes which reside on the Cu1 and O2 rung sites. Finally, nearly all holes transferred at room temperature into the ladders when pressure is applied occupy the O2 sites.

Figure 8 shows the distribution of holes located in the 2p orbitals of the oxygen rung site O2 in Ca12 between the 2p,a and 2p,c orbitals. As is seen in the figure, these holes go primarily in the 2p orbitals oriented along the a -axis of the rungs at increasing Ca content and pressure. This is in agreement with the conclusions of Ref. 14 where an enhancement of the hole density in the O 2p,a orbitals in going from Ca0 to Ca12 was found.

It has been shown in a number of theoretical studies that the spin gap value Δ_s in the spectrum of spin excitations of two-leg ladders is very sensitive to the degree of carrier doping of the Cu_2O_3 layer.^{35,36} Namely, Δ_s decreases as the hole number in the ladder plane is increased. Our previous NMR studies^{37,38,39} have revealed a substantial reduction of the spin gap under pressure. Since the applied pressure causes the transfer of holes from the chains to the ladders it is reasonable to explain the spin gap reduction under pressure by an increase of the hole density in the ladder layer. As mentioned above, the ladder layers of Ca12 contain a finite amount of non-localized holes even at low T the number of which increasing under pressure. Therefore, the growth of the residual spin susceptibility at low T at increasing pressure observed in our previous works^{37,38,39} can be related to the increase of single mobile holes in the ladders at low T . Such a situation leads in turn to a finite density of states at the Fermi level which contributes to the spin susceptibility as seen from the Korringa contribution to the NMR relaxation.

Note that the achievement of an appropriate carrier doping level due to the b -axis shrinkage under pressure is not a sufficient condition for a stabilization of superconductivity in Ca_x compounds. Otherwise, even a less substituted Ca_x sample should show superconductivity applying a high pressure. Experimentally, $\text{Sr}_4\text{Ca}_{10}\text{Cu}_{24}\text{O}_{41}$ did not reveal superconductivity up to 85 kbar.⁴⁰ Ca substitution has an effect on the lattice similar to high pressure although not equivalent.^{16,18} The lattice parameter \mathbf{a} in the Ca_x ladders shows hardly any change under pressure but on the other hand is very sensitive to Ca doping. For instance, an hydrostatic compression of a Ca8 sample up to 110 kbar cannot reduce the \mathbf{a} parameter down to its value in Ca12 under 30 kbar.¹⁶ Since a reduction of the \mathbf{a} parameter enhances the interladder interaction along the a -axis it leads to a more two-dimensional ladder system. We suggest that prerequisites for the stabilization of superconductivity in a spin-ladder are an adequate "two-

dimensional degree" and a large enough carrier doping level. Ca substitution is essential to achieve a two dimensional character while the necessary carrier density can only be attained by pressure.

V. CONCLUSION

In summary, we have reported a ^{63}Cu and ^{17}O NMR investigation of the nuclear quadrupole interaction tensor, $^{17,63}\nu_{Q,\alpha}$, in the hole doped spin ladder system $\text{Sr}_{14-x}\text{Ca}_x\text{Cu}_{24}\text{O}_{41}$ ($x=0$ and 12) at ambient pressure and under a pressure of 32 kbar when Ca12 ladders are superconducting. We have related the changes in $^{17,63}\nu_{Q,\alpha}$ to a variation in the effective hole concentration of the ladder layer and have determined the hole distribution among ladder and chain systems as a function of temperature, Ca content and an applied hydrostatic pressure. The results are summarized in Figs. 7 and 8.

The overall tendency of the temperature dependence for the hole density in the ladder layer is a reduction as temperature is lowered. The effective hole concentration in the Cu_2O_3 ladder plane of Ca0 compounds depends only weakly on the temperature below 150 K but increases steeply above 150 K. The additional hole number in ladder layers of Ca12 shows a dramatic change in the temperature range $\Delta T = 50 \div 200$ K and a T -independent behavior outside this region. Holes transferred from the chains to the ladders at increasing temperature occupy mainly the Cu $3d_{x^2-y^2}$ and the O $2p_c$ orbitals at the Cu1 and O1 sites of ladders.

An increase of the Ca content and of the applied pressure leads to an additional doping of the Cu_2O_3 ladder units. Ca substitution leads to a transfer of holes in the orbitals of Cu1 and rung oxygen O2 ions whereas under pressure nearly all transferred holes occupy the O $2p_a$ orbitals of O2 oxygens. A comparison between the effect of pressure and Ca substitution on the hole number in the ladder layers and of the lattice parameters suggests that the hole transfer from chains to ladders under

pressure and upon Ca doping is caused, at least for Ca poor compounds by a shrinkage of the intersheet CuO_2 - Cu_2O_3 distance. Furthermore, our results indicate that a rather substantial number of holes in the ladder planes of Ca12 is remaining delocalized down to the lowest temperature. We suggest that the important role of high pressure for realizing superconductivity in Ca12 is an increase of the hole density in the ladder layers. However, the stabilization of a superconducting ground state in the spin ladder $\text{Sr}_{14-x}\text{Ca}_x\text{Cu}_{24}\text{O}_{41}$ is achievable only at a rather high "2D degree" in the ladder plane. This two-dimensionality is obtained more by Ca substitution than by high pressure.

Finally, it is worth putting the behavior of superconducting spin ladders in the context of high T_c (HTSC) superconductors. Once enough 2-D character has been achieved by Ca doping, superconductivity can then be stabilized at a strongly pressure dependent critical temperature. T_c amounts to 5 K in Ca12 under 30 kbar³⁷ and passes through a maximum at 10K in Ca11.5⁴¹ and Ca13.6⁴² under 45 and 35 kbar respectively. As suggested by the present NMR/NQR study, pressure enhances the carrier concentration in the ladder planes. The pressure (hole concentration) dependence of T_c is also reminiscent of the parabolic dependence found for T_c versus the carrier concentration in many HTSC⁴³.

Acknowledgments

A. Revcolevschi, U. Ammerhal and G. Dhahlenne are gratefully acknowledged for the samples preparation. We thank A. Inyushkin for helping us with the ^{17}O isotope exchange process. Y.P. would like to thank S. Verkhovskii for useful discussions. Y.P. acknowledges the CNRS and "Russian Science Support Foundation" for a financial support. The work was supported by the Ministry of Sciences and Technology of the Russian Federation under contract No 25/03 and the Russian Foundation for Basic Researches (Project N 05-02-17846).

¹ E. Dagotto and T.M. Rice. *Science*, 271:618, 1996.

² E. Dagotto. *Rep. Prog. Phys.*, 62:1525, 1999.

³ E. Dagotto, J. Riera, and D. Scalapino. *Phys. Rev. B*, 45:R5744, 1992.

⁴ T. Nagata, H. Fujino, J. Akimitsu, M. Nishi, K. Kakurai, S. Katano, M. Hiroi, M. Sera, and N. Kobayashi. *J. Phys. Soc. Jpn.*, 68:2206, 1999.

⁵ S. Ohsugi, K. Magishi, S. Matsumoto, Y. Kitaoka, T. Nagata, and J. Akimitsu. *Phys. Rev. Lett.*, 82:4715, 1999.

⁶ T. Nagata, M. Uehara, J. Goto, J. Akimitsu, N. Motoyama, H. Eisaki, S. Uchida, H. Takahashi, T. Nakanishi, and N. Mori. *Phys. Rev. Lett.*, 81:1090, 1998.

⁷ T. Osafune, N. Motoyama, H. Eisaki, and S. Uchida. *Phys. Rev. Lett.*, 78:1980, 1997.

⁸ Y. Mizuno, T. Tohyama, and S. Maekawa. *J. Phys. Soc. Jpn*, 66:937, 1997.

⁹ N. Motoyama, T. Osafune, T. Kakeshita, H. Eisaki, and S. Uchida. *Phys. Rev. B*, 55:R3386, 1997.

¹⁰ M. Kato, K. Shiota, and Y. Koike. *Physica C*, 258:284, 1996.

¹¹ E.M. McCarron, M.A. Subramanian, J.C. Calabrese, and R.L. Harlow. *Mater. Res. Bull.*, 23:1355, 1988.

¹² K. Magishi, S. Matsumoto, Y. Kitaoka, K. Ishida, K. Asayama, M. Uehara, T. Nagata, and J. Akimitsu. *Phys. Rev. B*, 57:11533, 1998.

¹³ M. Isobe, M. Onoda, T. Ohta, F. Izumi, K. Kimoto, E. Takayama-Muromachi, A.W. Hewat, and K. Ohoyama. *Phys. Rev. B*, 62:11667, 2000.

¹⁴ N. Nücker, M. Merz, C. A. Kuntscher, S. Gerhold, S. Schuppler, R. Neudert, M. S. Golden, J. Fink, D. Schild, S. Stadler, V. Chakarian, J. Freeland, Y. U. Idzerda, K. Conder, M. Uehara, T. Nagata, J. Goto, J. Akimitsu,

- N. Motoyama, H. Eisaki, S. Uchida, U. Ammerahl, and A. Revcolevschi. *Phys. Rev. B*, 62:14384, 2000.
- ¹⁵ K.R. Thurber, K.M. Shen, A.W. Hunt, T. Imai, and F.C. Chou. *Phys. Rev. B*, 67:094512, 2003.
- ¹⁶ S. Pachot, P. Bordet, R.J. Cava, C. Chaillout, C. Darie, M. Hanfland, M. Marezio, and H. Takagi. *Phys. Rev. B*, 59:12048, 1999.
- ¹⁷ S. Pachot. *Ph D. thesis*, 1999.
- ¹⁸ M. Isobe, T. Ohta, M. Onoda, F. Izumi, S. Nakano, J.Q. Li, Y. Matsui, E. Takayama-Muromachi, T. Matsumoto, and H. Hayakawa. *Phys. Rev. B*, 57:613, 1998.
- ¹⁹ L.P. Regnault, J.P. Boucher, H. Moudden, J.E. Lorenzo, A. Hiess, U. Ammerahl, G. Dhahlenne, and A. Revcolevschi. *Phys. Rev. B*, 59:1055, 1999.
- ²⁰ Y. Piskunov, D. Jérôme, P. Auban-Senzier, P. Wzietek, and A. Yakubovsky. *Phys. Rev. B*, 69:014510, 2004.
- ²¹ P. Carretta, S. Aldrovandi, R. Sala, P. Ghigna, and A. Lascialfari. *Phys. Rev. B*, 56:14587, 1997.
- ²² M. Takigawa, N. Motoyama, H. Eisaki, and S. Uchida. *Phys. Rev. B*, 57:1124, 1998.
- ²³ T. Imai, K.R. Thurber, K.M. Shen, A.W. Hunt, and F.C. Chou. *Phys. Rev. Lett.*, 81:220, 1998.
- ²⁴ M.H. Cohen and F. Rief. *Solid State Phys.*, 5:321, 1957.
- ²⁵ K. Hanzawa. *J. Phys. Soc. Jpn*, 62:3302, 1993.
- ²⁶ T. Shimizu. *J. Phys. Soc. Jpn*, 62:772, 1993.
- ²⁷ M.V. Eremin and O.V. Lavizina. *J. Exp. Theor. Phys. (JETP)*, 84:80, 1997.
- ²⁸ E. Clementi and A.D. McLean. *Phys. Rev.*, 133:A419, 1964.
- ²⁹ M. Takigawa, P.C. Hammel, R.H. Heffner, Z. Fisk, K.C. Ott, and J.D. Thompson. *Phys. Rev. Lett.*, 63:1865, 1989.
- ³⁰ B. Gorshunov, P. Haas, T. Room, M. Dressel, T. Vuletic, B. Korin-Hamzic, S. Tomic, J. Akimitsu, and T. Nagata. *Phys. Rev. B*, 66:060508(R), 2002.
- ³¹ P. Abbamonte, G. Blumberg, A. Rusydi, P.G. Evans, T. Siegrist, A. Gozar, H. Eisaki, E.D. Isaacs, and G.A. Sawatsky. *Science*, 431:1078, 2004.
- ³² T. Vuletic, B. Korin-Hamzic, S. Tomic, B. Gorshunov, P. Haas, T. Room, M. Dressel, J. Akimitsu, T. Sasaki, and T. Nagata. *Phys. Rev. Lett.*, 90:257002-1, 2003.
- ³³ In case an entire hole were localized on a site it would shift the NMR signal away from the NMR frequency window.
- ³⁴ A. Gellé and M.B. Lepetit. *Phys. Rev. Lett.*, 92:236402-1, 2004.
- ³⁵ R.M. Noack, S.R. White, and D.J. Scalapino. *Phys. Rev. Lett.*, 73:882, 1994.
- ³⁶ L. Campos Venuti and A. Muramatsu. *Phys. Rev. B*, 66:184510, 2002.
- ³⁷ H. Mayaffre, P. Auban-Senzier, M. Nardone, D. Jérôme, D. Poiblan, C. Bourbonnais, U. Ammerahl, G. Dhahlenne, and A. Revcolevschi. *Science*, 279:345, 1998.
- ³⁸ Y. Piskunov, D. Jérôme, P. Auban-Senzier, P. Wzietek, Y. Ammerahl, G. Dhahlenne, and A. Revcolevschi. *Eur. Phys. J. B*, 13:417, 2000.
- ³⁹ Y. Piskunov, D. Jérôme, P. Auban-Senzier, P. Wzietek, C. Bourbonnais, U. Ammerahl, G. Dhahlenne, and A. Revcolevschi. *Eur. Phys. Jour. B*, 24:443, 2001.
- ⁴⁰ N. Môri, H. Takahashi, and T. Nakanishi. in *Solid State Physics*, volume 31, page 797. Agne-Gijutsu-Center, Tokyo, 1996.
- ⁴¹ T. Nagata, M. Uehara, J. Goto, N. Komiya, J. Akimitsu, N. Motoyama, H. Eisaki, S. Uchida, H. Takahashi, T. Nakanishi, and N. Mori. *Physica C*, 282-287:153, 1997.
- ⁴² H. Takahashi, N. Mori, T. Nakanishi, T. Nagata, M. Uehara, J. Akimitsu, and K. Kinoshita. *Physica B*, 237-238:112, 1997.
- ⁴³ J.L. Tallon, J.R. Cooper, P.S.I.P.N. deSilva, G.V.M. Williams, and J.W. Loram. *Phys. Rev. Lett.*, 75:4114, 1995.