



HAL
open science

A hypocoloring model for batch scheduling

Dominique de Werra, Marc Demange, Jérôme Monnot, Vangelis Th. Paschos

► **To cite this version:**

Dominique de Werra, Marc Demange, Jérôme Monnot, Vangelis Th. Paschos. A hypocoloring model for batch scheduling. *Discrete Applied Mathematics*, 2005, 146 (1), pp.3-26. 10.1016/j.dam.2004.06.016 . hal-00004032

HAL Id: hal-00004032

<https://hal.science/hal-00004032>

Submitted on 23 Jan 2005

HAL is a multi-disciplinary open access archive for the deposit and dissemination of scientific research documents, whether they are published or not. The documents may come from teaching and research institutions in France or abroad, or from public or private research centers.

L'archive ouverte pluridisciplinaire **HAL**, est destinée au dépôt et à la diffusion de documents scientifiques de niveau recherche, publiés ou non, émanant des établissements d'enseignement et de recherche français ou étrangers, des laboratoires publics ou privés.

A hypocoloring model for batch scheduling

Dominique de Werra^{*} Marc Demange[†] Jérôme Monnot[‡] Vangelis Th. Paschos[‡]

Abstract

Starting from a batch scheduling problem, we consider a weighted subcoloring in a graph G ; each node v has a weight $w(v)$; each color class S is a subset of nodes which generates a collection of node disjoint cliques. The weight $w(S)$ is defined as $\max\{w(K) = \sum_{v \in K} w(v) \mid K \in S\}$.

In the scheduling problem, the completion time is given by $\sum_{i=1}^k w(S_i)$ where $\mathcal{S} = (S_1, \dots, S_k)$ is a partition of the node set of graph G into color classes as defined above.

Properties of such colorings concerning special classes of graphs (line graphs of cacti, block graphs) are stated; complexity and approximability results are presented. The associated decision problem is shown to be **NP-complete** for bipartite graphs with maximum degree at most 39 and triangle-free planar graphs with maximum degree k for any $k \geq 3$. Polynomial algorithms are given for graphs with maximum degree two and for the forests with maximum degree k . An (exponential) algorithm based on a simple separation principle is sketched for graphs without triangles.

Keywords: Batch scheduling; Graph coloring; Subcolorings, Hypocolorings; Weighted colorings; Approximability; NP-complete.

1 Introduction

Chromatic scheduling is the domain of scheduling problems which can be formulated in terms of graph coloring or more precisely of generalized graph coloring (i.e., coloring with a few additional requirements).

The development of chromatic scheduling have thus generated various extensions of graph coloring motivated by applications like course timetabling or processor scheduling problems or satellite communication.

In particular the concept of weighted coloring has been introduced to generalize classical coloring models and to handle situations where operations occur with possibly different processing times. In this paper, we shall generalize a weighted coloring model used in demange et al. [9] for studying some types of batch scheduling problems. Such a generalization of classical coloring appears in Fiala et al. [11], Albertson et al. [1] and Brown and Corneil [8] but simply as a variation of coloring problems. We also refer the reader to Broersma et al. [6]. To our knowledge the weighted case has not been studied specifically.

^{*}Ecole Polytechnique Fédérale de Lausanne, Switzerland, dewerra@ima.epfl.ch

[†]ESSEC, Dept. SID, France, demange@essec.fr

[‡]LAMSADE, Université Paris-Dauphine, France, {monnot,paschos}@lamsade.dauphine.fr

After motivating the use of such weighted coloring by means of batch scheduling, we will recall some complexity results related to these colorings and derive some complementary properties together with approximation results. We will also characterize a few solvable cases (graphs of degree 2) and an enumeration algorithm generalizing a classical coloring technique will be given for triangle-free graphs. The last section will present some possible extensions of these types of weighted colorings.

For all graph theoretical terms not defined here, the reader is referred to Berge [3] and, for all definitions related to complexity, to Garey and Johnson [12].

2 A chromatic scheduling model

In order to describe our generalized weighted coloring model, we shall consider an instance of batch scheduling problem which can be stated as follows:

We are given a finite set V of operations v to be processed on some identical processors whose properties will be stated later. Each operation has a positive (generally integral) processing time $w(v)$ which does not depend on the processor. No preemptions will be allowed during the processing of an operation. Each processor will handle one operation at a time. In addition, there are some incompatibilities between pairs of operations u, v ; if the pair u, v is *incompatible* then operations u and v cannot be processed simultaneously (on different processors).

At this stage we may associate to each operation v a node v of a graph $G = (V, E)$; the set E of incompatible pairs of operations will be associated with the edge set of G . Each node v will have a *weight* $w(v)$. Now a *batch* S of operations is a collection of pairwise compatible operations; the operations in S are assigned to different processors (assuming there is a large enough number of processors) and they are processed simultaneously. So all operations in S are completed when the operation v with the largest processing time $w(v)$ is completed. At this stage, the set S corresponds to a stable set in G . It is then natural to define the weight $w(S)$ as $w(S) = \max\{w(v) \mid v \in S\}$. Assigning each operation to some batch corresponds then to partitioning the node set V of graph G into a number k of stable sets. This is precisely the problem of finding a k -coloring $\mathcal{S} = (S_1, \dots, S_k)$ of G such that $C(\mathcal{S}) = w(S_1) + \dots + w(S_k)$ is minimum.

There are many situations where operations have to be assigned to batches (of compatible operations) which are processed one after the other (see Boudhar and Finke [5] for some examples). Examples in satellite communication and in production have also been modeled as special cases of the above batch scheduling problem (see Rendl [17], Boudhar and Finke [5]).

In the above model all operations in a batch are assigned to different processors and processed simultaneously. The processing time of a batch S is limited by the largest processing time of the operations in S . If the processing times may take different values, it may be worthwhile to assign two (or more) incompatible operations v with small processing times $w(v)$ to the same batch; they will be processed consecutively on the same processor. This will not increase the processing time $w(S)$ of the batch S as long as the sum of processing times of these operations does not exceed the longest processing time $w(v)$ in S .

In order to allow this possibility in our model, we have to generalize the definition of a stable set

in a graph G . We may view a stable set S in a graph G as a set of nodes which induces a collection of node disjoint cliques of size one (without any edges between them).

In a similar way, we shall say that a subset S of nodes is *hypostable set* in G if it induces a collection of node disjoint cliques (without any edges between them).

In our batch scheduling model, we shall in a natural way define the weight $w(K)$ of a clique K as $w(K) = \sum_{v \in K} w(v)$. Since K corresponds to incompatible operations (assigned to the same processor), the processing time of all operations in K will be the sum of all processing times. As a consequence, the weight of a hypostable set S will be $w(S) = \max\{w(K) \mid K \in S\}$.

In the case of stable sets, we have $|K| = 1$ for each clique K in S .

Our batch scheduling problem now consists in finding a k -hypocoloring $\mathcal{S} = (S_1, \dots, S_k)$ of the nodes of G , i.e., a partition of the node set into hypostable sets such that:

$$\widehat{K}(\mathcal{S}) = \sum_{i=1}^k w(S_i) \text{ is minimum} \quad (2.1)$$

Observe that k is generally not given; its value results from the minimization of \widehat{K} .

Assume we have a collection of people who have expressed some mutual compatibility (represented by edges of a graph whose nodes are the people). Each person v needs a certain number $w(v)$ of time units to tell his (her) stories. We want to invite each one of these people to a banquet where different tables are set for each banquet. The natural requirements are that we want to place at a same table people who are all compatible. At any table each person will tell successively his (her) stories. So for each table we will need an amount of time equal to the sum of the $w(v)$ of the persons v sitting at this table. In addition in order to avoid frustration we would require that on any given banquet there are no two people sitting at different tables who would have liked to be together (no edge between their nodes). The duration of a banquet will be the maximum time needed for the tables set up for this banquet. We want to invite each person to one banquet exactly and we want to find an assignment of the people to banquets (batches) and more precisely to tables in this banquet so that the total duration of the banquets is minimum (it is proportional to the cost of hiring personal to serve meals in the banquets). This is precisely a weighted hypocoloring of a graph with a minimum cost.

The above model may also be used for representing some machine scheduling problems: we are for instance given a collection of jobs v with processing times $w(v)$ in a flexible manufacturing system; we link the nodes representing two jobs if these share a certain number of tools ; it will thus be interesting to assign these jobs to a same machine on which the appropriate tools (and some others as well) will be installed. A batch will consist of an assignment of jobs to some machines in which we try to assign to a same machine jobs which share some tools. Since there is only a limited number of tools of each type, we will try to assign to different machines jobs which do not need the same tools. Hence a batch will be represented by a hypostable set in the graph of compatibilities (common tools) and the processing time of a batch will again be the maximum load of a machine (maximum of the sums of processing times of jobs assigned to the same machine) . We shall concentrate on this model of weighted hypocoloring which is motivated in a natural way by the batch scheduling context. For

clarifying purposes some results will be derived for this special model and we will mention in the last section how these ideas may be transposed to more general situations

3 Some special cases

Getting back to the definition of k -hypocolorings in a graph G we may by analogy define the hypochromatic number $\chi_h(G)$ of G as the smallest k for which G has a k -hypocoloring. Recognizing if $\chi_h(G) \leq 2$ for graph G is difficult (see Fiala et al. [11]); so, we will simply derive a few cases where the hypochromatic number can be obtained easily. In Broersma et al. [6], it is shown that the problem is easy for complements of bipartite graphs.

A *cactus* is a connected simple graph where any two elementary cycles have at most one node in common. By definition a cactus will have neither loops nor multiple edges.

Let G be the line graph $L(H)$ of a simple graph H ; then any k -hypocoloring of the nodes of G corresponds to an "edge k -hypocoloring" in H , i.e., a partition of the edge set of H into k subsets which may be called *hypostable*. There is a one-to-one correspondence between hypostable sets of nodes in G and hypostable sets of edges in H . It is not difficult to verify that a subset E' of edges in H is hypostable set iff it consists of node disjoint sets of stars (set of edges with exactly one common node) and triangles.

Before stating some results on the hypochromatic number of line graphs of cacti, let us introduce an auxiliary graph which will be useful later.

We are given a cactus H ; its blocks (2-connected components) will by definition be elementary cycles and edges not contained in any cycle (these are cut-edges). We associate with each block of H a node b ; then for each node v of H which is in at least two blocks we introduce a node v . We link each b to the nodes v corresponding to nodes of G which block b contains to obtain the auxiliary graph $G(H)$. It is easy to verify that if H is a cactus then $G(H)$ is a tree.

In $G(H)$ we can then choose an arbitrary node b (corresponding to a block) as a root and orient all its edges (which become arcs) away from b . We may next assign numbers $n(b)$ to the nodes b (corresponding to blocks) in such a way that whenever there is a path from b_i to b_j then $n(b_i) < n(b_j)$. This will define the coloring order to be used later.

A cactus is *bipartite* if it contains no (elementary) odd cycles.

Consider for instance the bipartite cactus given in Figure 1;

a bicoloring of the edges of H (heavy edges, light edges) is shown. Since the edge set of H is not a union of node disjoint stars and triangles, we have $\chi_h(L(H)) = 2$. Figure 2 represents a bipartite cactus obtained from the previous one by introducing a pendent edge $[e, f]$ at node e .

Let us try to color its edges with two colors; clearly in the cycle on nodes a, b, c, d we must have two heavy and two light edges. Assume w.l.o.g. that $[a, b]$ and $[a, d]$ are heavy, so that $[b, c]$ and $[c, d]$ are light; then $[d, g]$ cannot be colored (heavy or light). So, we may assume w.l.o.g. that $[a, b]$, $[c, d]$ are light and $[b, c]$, $[a, d]$ are heavy.

- case 1: $[c, e]$ is heavy. Then $[e, f]$, $[e, h]$ are light, $[h, i]$ is heavy, $[c, i]$ is light. Hence, $[d, g]$

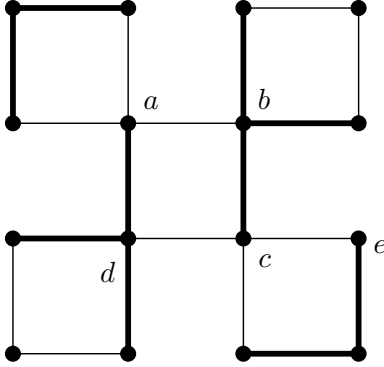

Figure 1: a bipartite cactus H with $\chi_h(L(H)) = 2$

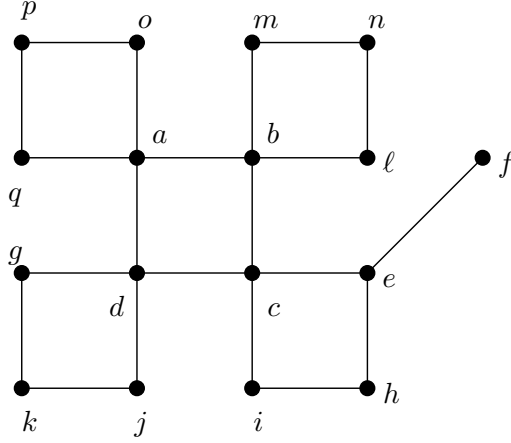

Figure 2: a bipartite cactus H with $\chi_h(L(H)) > 2$

and $[d, j]$ are heavy. So, $[a, q]$ is light. And now $[b, l]$ cannot be light (since $[a, q]$ and $[a, b]$ are light) and it cannot be heavy (since $[c, e]$ and $[b, c]$ are heavy).

- case 2: $[c, e]$ is light. Then $[e, f]$, $[e, h]$ are heavy, $[h, i]$ is light, and $[c, i]$ is heavy. Hence, $[d, j]$ is heavy. It follows that $[a, o]$ and $[b, m]$ must be light (otherwise, we could have three consecutive heavy edges). So, now $[a, o]$, $[a, b]$, $[b, m]$ are three consecutive light edges, which is not allowed.

All cases have been examined, so $\chi_h(L(H)) > 2$.

The construction given in the proof of proposition 3.1 will show that for bipartite cactus of Fig. 2, we have $\chi_h(L(H)) = 3$. It will be based on the auxiliary graph $G(H)$.

Proposition 3.1 *If G is the line graph $L(H)$ of a cactus H , then $\chi_h(L(H)) \leq 3$*

Proof: We shall color consecutively the edges in each two-connected component of H in the order defined by means of the auxiliary graph $G(H)$.

We start from the component b_1 and color its edges by using alternately colors a, b, c (if b_1 is just one edge, we use just color a). So, we have colored the component b_1 which corresponds to the root of the oriented tree in $G(H)$.

At each node of b_1 , at most two colors appear on adjacent edges. We consider now every cut-node v of b_1 and color all (uncolored yet) adjacent edges with one of the colors a, b, c which does not occur around v . This is always possible.

Now, we consider all components b_i containing these edges and color their remaining edges alternately with the two colors not used yet in b_i (if b_i is a single edge, we do nothing).

At this stage, in each such b_i all nodes (except possibly the cut-node between b_1 and b_i) have one color at least which does not occur on adjacent edges. So, we can continue coloring the component b_i , one after the other in any order which follows the partial order defined by the oriented tree. At each cut-node v , it will be possible to find an unused color among $\{a, b, c\}$ to color the edges of the "adjacent" component b_i (such that (v, b_i) is an arc in $G(H)$). This will finally give an edge 3-coloring of H where each color class contains no three consecutive edges, and hence it will correspond to a 3-hypocoloring in $L(H)$. \square

It would be interesting to characterize the graphs H for which $\chi_h(L(H)) \leq 2$. The example of bipartite cactus given above may suggest that such a characterization is not immediate. In this direction, we can state a property of *block graphs*; these are graphs where each block (two-connected component) is a clique.

Proposition 3.2 *If G is a connected block graph, then $\chi_h(G) \leq 2$. In particular, if $G = L(T)$ is the line graph of a tree, then $\chi_h(L(T)) \leq 2$*

Proof: A graph is the line graph $L(T)$ of a tree if and only if it is a block graph where each node is contained in at most two blocks. So, the result for $L(T)$ follows from the general case of block graphs.

Let G be a block graph, we may associate with it an auxiliary graph G' as follows:

each block b (maximal clique) of G is associated with a node b of G' ; each cut-node v (i.e., each node belonging to at least two blocks) becomes a node v of G' .

We link each b to the node v corresponding to node v of G which are in the block b .

It is again easy to verify that such a graph G' is a tree. We can choose a node b (corresponding to a block of G) as root and orient all edges from the root.

Then as before we will color the node of each block in any order respecting the orientations of the arcs of G' . All nodes of the clique b_1 corresponding to the root are colored with color α . Then we consider consecutively all cut-nodes in b_1 . We color the remaining nodes of all blocks having a node in common with b_1 with color β these are the blocks at distance 2 from b_1 in G'). More generally having colored some blocks by following paths from b_1 in G' , we consider the cut-nodes in these blocks. We color the remaining nodes of these blocks with the color not used for these cut-nodes.

We continue in this way until all nodes are colored with α or β . The construction will always be possible since any two blocks have at most one node in common. Each color class will consist

of cliques of G which are node disjoint and furthermore there is no edge of G between two different cliques of the same color. So, we have obtained a 2-hypocoloring of G . If G is simply a clique, then $\chi_h(G) = 1$. \square

4 Properties of optimal hypocolorings

We will derive here some properties which are based on the fact that hypocolorings are in some sense extensions of node colorings; the following is a simple extension of the observation that the number of colors used in an optimal weighted coloration of a simple graph does not exceed $\Delta(G) + 1$ (see Demange et al. [9]).

Lemma 4.1 *In a weighted graph $I = (G, w)$ such that $\forall v \in V, w(v) > 0$, any k -hypocoloring \mathcal{S} with minimum cost $\widehat{K}(\mathcal{S})$ satisfies $k \leq \Delta(G) + 1$*

Proof: We shall show that any l -hypocoloring $\mathcal{S}' = (S'_1, \dots, S'_l)$ with $l > \Delta(G) + 1$ can be transformed into a k -hypocoloring \mathcal{S} with $k \leq \Delta(G) + 1$ and $\widehat{K}(\mathcal{S}) < \widehat{K}(\mathcal{S}')$. Moreover, this construction is done in polynomial time. As usual we assume $w(S'_1) \geq w(S'_2) \geq \dots \geq w(S'_l)$; assume $S'_l \neq \emptyset$, so there is a node $x \in S'_l$. It has at most $\Delta(G)$ neighbors. Since, $l > \Delta(G) + 1$, there is at least one color say s , which satisfies $s \leq \Delta(G) + 1 < l$ and which does not occur in the neighborhood $N(x)$. So, we can recolor x with color s and setting $S_s^* = S'_s \cup \{x\}$, we have $w(S_s^*) = w(S'_s)$ since $w(x) \leq w(S'_l) \leq w(S'_s)$. Setting $S_i^* = S'_i$, ($i \neq s, l$) we get a l -hypocoloring \mathcal{S}^* with $|S_i^*| < |S'_l|$ and $\widehat{K}(\mathcal{S}^*) \leq \widehat{K}(\mathcal{S}')$. We repeat this until all nodes in S'_l have been recolored with a smaller color, then we continue until there are no more nodes with colors $s > \Delta(G) + 1$. At the end, the cost of the resulting hypocoloring verifies $\widehat{K}(\mathcal{S}^*) < \widehat{K}(\mathcal{S}')$ since we have assumed $\forall v \in V, w(v) > 0$. \square

This bound is not the best possible; by analogy with the the theorem of Brooks ([7]), we could try to get a bound of $\Delta(G)$ instead of $\Delta(G) + 1$. The bound $\Delta(G) + 1$ is attained when G is a clique but in this case, we also have an optimal solution with exactly i colors for any $1 \leq i \leq \Delta(G) + 1$. This motivates the next improvement of the bound.

We now state some results which hold for general graphs G with maximum degree $\Delta(G)$

Proposition 4.2 *If $I = (G, w)$ is a weighted graph with maximum degree $\Delta(G)$ then there exists a k -hypocoloring $\mathcal{S} = (S_1, \dots, S_k)$ with minimum cost $\widehat{K}(\mathcal{S})$ satisfying the following:*

- (i) $k \leq \Delta(G)$
- (ii) $\forall i \leq k, \forall v \in S_i, d_{G_{i,v}}(v) \geq i - 1$ where $G_{i,v}$ is the subgraph of G induced by $S_1 \cup \dots \cup S_{i-1} \cup \{v\}$
- (iii) $\forall i \leq k, S_i$ contains no $K_{\Delta(G)+3-i}$

Proof: Let us consider an optimum k -hypocoloring \mathcal{S} .

For (i): From lemma (4.1), we have $k \leq \Delta(G) + 1$. If $k \leq \Delta(G)$, we are done. So, assume $k = \Delta(G) + 1$ and we have a k -hypocoloring with a minimum number of nodes with color k , i.e., $|S_k|$

is minimum. Let v be a node in S_k . If there is some color $s \leq \Delta(G)$ missing in the neighborhood $N(v)$ then we can recolor v with s and we obtain a k -hypocoloring \mathcal{S}' with $\widehat{K}(\mathcal{S}') \leq \widehat{K}(\mathcal{S})$ and $|S'_k| < |S_k|$, a contradiction.

So, we can assume that all colors $1, \dots, \Delta(G)$ occur in $N(v)$. Let u be a neighbor of v in $S_{\Delta(G)}$ (i.e., $u \in N(v) \cap S_{\Delta(G)}$); u has some color $c \leq \Delta(G)$ missing in $N(u)$ since $v \in S_{\Delta(G)+1}$ is in $N(u)$.

If $c < \Delta(G)$, then we can recolor u with c and then v can be recolored with $\Delta(G)$; we still have a k -hypocoloring and the cost has not increased. Again $|S'_k| < |S_k|$, a contradiction.

So we must have color $c = \Delta(G)$ missing in $N(u)$. We recolor v with color $c = \Delta(G)$ and we get a new k -hypocoloring (edge $[v, u]$ is now in $S'_{\Delta(G)}$).

Repeat this as long as there are nodes with color $k = \Delta(G) + 1$, we will finally have a $\Delta(G)$ -hypocoloring $\mathcal{S}' = (S'_1, \dots, S'_{\Delta(G)})$ with $\widehat{K}(\mathcal{S}') \leq \widehat{K}(\mathcal{S})$ because $w(S'_{\Delta(G)}) \leq w(S_{\Delta(G)}) + w(S_{\Delta(G)+1})$. This is a contradiction again. Since we have examined all cases, (i) is proven.

For (ii): The proof is exactly the same as previously. If $d_{G_{i,v}}(v) < i - 1$ for some $v \in S_i$ then, we can recolor v with some color missing in $\{1, \dots, i - 1\}$ without increasing the cost of the hypocoloring. We repeat this as long as possible and the result follows.

For (iii): Assume that S_i contains a $K_{\Delta(G)+3-i}$ and let v be a node of this clique. Since $d_G(v) \leq \Delta(G)$, we deduce that $d_{G_{i,v}}(v) \leq d_G(v) - (\Delta(G) + 2 - i) \leq i - 2$ which gives a contradiction with (ii). \square

Remark 4.3 *We observe that it is always possible to find in polynomial time, a hypocoloring which verifies proposition (4.2). In other words, we can polynomially transform a hypocoloring \mathcal{S} satisfying lemma (4.1) into a hypocoloring \mathcal{S}' satisfying proposition (4.2) and verifying $\widehat{K}(\mathcal{S}') \leq \widehat{K}(\mathcal{S})$.*

Remark 4.4 *The bound (i) is best possible: for every integer p , there exists a tree G with $\Delta(G) = p$ and weights $w(v)$ for the nodes of G such that all optimal k -hypocolorings have $k = p$ colors.*

G is constructed as follows: start from the tree T_2 for $p = 2$; it consists of a chain a, b, c where nodes have labels $l(a) = l(c) = 2$, $l(b) = 1$ and $w(a) = w(c) = 10^1$, $w(b) = 10^0$.

Generally having obtained tree T_{i-1} (where nodes have labels in $1, 2, \dots, i - 1$ and weights at most 10^{i-2}) we construct T_i by introducing at each node v of T_{i-1} a chain of two additional nodes v', v'' where these new nodes have label i and weights $(1/2)10^{i-1}$. Now in T_i we take one of these new chains v', v'' such that the node adjacent in T_{i-1} has a cost 10^{i-2} and we condense the edge $[v', v'']$ into the node v_i (the weight of the new node is $w(v_i) = w(v') + w(v'') = 10^{i-1}$).

One can verify that the graph T_i is a tree with maximum degree i ; one also observes that the labels define a p -hypocoloring $\mathcal{S} = (S_1, \dots, S_p)$ where $S_i = \{v \mid l(v) = p + 1 - i\}$. Furthermore one can verify that \mathcal{S} is the unique optimum hypocoloring.

We can also obtain a bound of the number of different colors used in any optimal coloring \mathcal{S}^* using the size $|w|$ of the weight function w (i.e., the number of distinct values of the weights w) and the chromatic number $\chi(G)$ of G . We will denote by $|w|$ the size of w :

Proposition 4.5 *Let $I = (G, w)$ be a weighted graph such that $w(v) > 0$ for each $v \in V$, then any hypocoloring $\mathcal{S}^* = (S_1, \dots, S_k)$ with minimum cost $\widehat{K}(\mathcal{S})$ satisfies: $k = |\mathcal{S}^*| \leq 1 + |w|(\chi(G) - 1)$.*

Proof: Let $I = (G, w)$ be a weighted graph such that $|w| \geq 1$ and $\mathcal{S}^* = (S_1, \dots, S_\ell)$ be an optimal hypocoloring of G with $w(S_1) \geq \dots \geq w(S_\ell)$. We show that $l = |\mathcal{S}^*| \leq 1 + |w|(\chi(G) - 1)$ by using an inductive proof on $|w|$:

Let $t = \max\{i : w(S_i) \geq \max_{v \in V} w(v)\}$. Remark that $t \leq \chi(G)$ since otherwise, an optimal coloring gives a better solution. Moreover, if $t = |\mathcal{S}^*| = \ell$, then we deduce $\widehat{K}(\mathcal{S}^*) \geq \ell w_{max}$; on the other hand, an optimal coloring is a feasible solution with a cost at most $w_{max}\chi(G)$. Thus, we obtain $\ell w_{max} \leq \widehat{K}(\mathcal{S}^*) \leq w_{max}\chi(G)$ and since $|w| \geq 1$, we also have $\chi(G) \leq 1 + |w|(\chi(G) - 1)$.

Now, assume $t < |\mathcal{S}^*|$; we deduce $t \leq \chi(G) - 1$ since otherwise an optimal coloring of G gives a better solution. Observe that $\mathcal{S}' = (S_{t+1}, \dots, S_k)$ is an optimal hypocoloring on the sub-instance $I' = (G', w')$ where G' is the subgraph of G induced by $V' = S_{t+1} \cup \dots \cup S_\ell$ and w' is the restriction of w to G' . By construction $I' \neq \emptyset$ since $t < |\mathcal{S}^*|$. Moreover, $|w'| \leq |w| - 1$. Thus, using an inductive hypothesis, we have

$$\ell - t = |\mathcal{S}'| \leq 1 + |w'|(\chi(G') - 1) \leq 1 + (|w| - 1)(\chi(G) - 1) \quad (4.1)$$

and the result follows since $t \leq \chi(G) - 1$. \square

5 Complexity of hypocoloring

Before presenting some complexity results for the hypocoloring problem, we will state a simple observation. It is a direct consequence of the fact that for any hypocoloring \mathcal{S} and for any clique K of a graph G , $\widehat{K}(\mathcal{S}) \geq w(K)$.

Property 5.1 *Let G be a complete k -partite weighted graph on sets L_1, \dots, L_k ; then an optimum hypocoloring is $\mathcal{S} = (L_1, \dots, L_k)$; furthermore it satisfies: $\widehat{K}(\mathcal{S}) = \max\{w(K) : K \text{ is a clique of } G\}$.*

More generally assume that a graph G has a k -coloring $\mathcal{S} = (S_1, \dots, S_k)$ and let $v_i \in S_i$ be a node of maximum weight in S_i ($i = 1, \dots, k$).

Then if $\{v_1, \dots, v_k\}$ forms a clique in G , \mathcal{S} is an optimum hypocoloring and $\widehat{K}(\mathcal{S}) = \max\{w(K) : K \text{ is a clique of } G\} = w(v_1) + \dots + w(v_k)$.

We will now show that the hypocoloring problem is close to the coloring problem in some cases; more precisely, we prove that the hypocoloring problem is **NP-hard** for a class Ψ of graphs as soon as the coloring problem is difficult enough in this class of graphs. On the other hand, this problem is also **NP-hard** for bipartite graphs even though the coloring problem is polynomial for these graphs.

Proposition 5.2 *Let Ψ be a class of graphs. If the restriction of the coloring problem is **NP-hard** for the Ψ -graphs, then the hypocoloring problem is strongly **NP-hard** for the graphs of Ψ .*

Proof: Let Ψ be a class of graphs and assume that the coloring problem is **NP-hard** for the restriction to Ψ -graphs. Let $G \in \Psi$, and consider the instance $I = (G, w_0)$ where the cost of each node is equal to one (i.e., $w_0(v) = 1, \forall v \in V$). Let $\mathcal{S}^* = (S_1, \dots, S_k)$ be an optimum hypocoloring of G ; we will show that $\chi(G) = \widehat{K}(\mathcal{S}^*)$.

We have $\widehat{K}(\mathcal{S}^*) \leq \chi(G)$ since any coloring of G is also a hypocoloring of I with the same cost. Conversely, for each $i \leq k$, S_i consists of node disjoint cliques K_1, \dots, K_{j_i} and by choice of w_0 , we have $w(S_i) = \max_{1 \leq p \leq j_i} |K_p|$. So, the hypostable set S_i can be partitioned in at most $\max_{1 \leq p \leq j_i} |K_p|$ stable sets, just picking one node in each clique K_i . We apply the same procedure for each hypostable and we obtain a coloring of G with $\widehat{K}(\mathcal{S}^*)$ colors and the result follows. \square

We will show in section (7.2), that the hypocoloring problem is polynomial when the maximum degree is at most 2. On the other hand, we now prove that when G is a triangle-free graph with maximum degree 3 and w can take only two different values, then the hypocoloring problem is strongly **NP-hard**.

We start with $1 - IN\ 3SAT$ proved to be **NP-complete** in Schaefer ([18]); this problem is defined as follows: Given a collection \mathcal{C} of m clauses over the set X of n Boolean variables such that each clause has exactly three literals, is there a truth assignment f satisfying \mathcal{C} such that each clause in \mathcal{C} has exactly one true literal?

Theorem 5.3 *The hypocoloring problem is strongly NP-hard for triangle-free graphs with maximum degree 3.*

Proof: We shall reduce $1 - IN\ 3SAT$ to our problem. Let $\mathcal{C} = (C_1, \dots, C_m)$ be a collection of m clauses with variable set $X = \{x_1, \dots, x_n\}$ such that every clause C_j of \mathcal{C} contains exactly three literals, $C_j = x \vee y \vee z$ where each literal x or y or z is either x_k or $\overline{x_k}$ for some suitable k .

From instance $I = (\mathcal{C}, X)$ of $1 - IN\ 3SAT$, we construct an instance $I' = (G, w)$ of hypocoloring such that the answer of I is yes if and only if there exists a hypocoloring \mathcal{S} of I' with cost $\widehat{K}(\mathcal{S}) \leq 3$.

We use two gadgets: gadget clause and gadget variable. From the clause $C_i = x \vee y \vee z$, we build the graph F_i described in Figure 3.

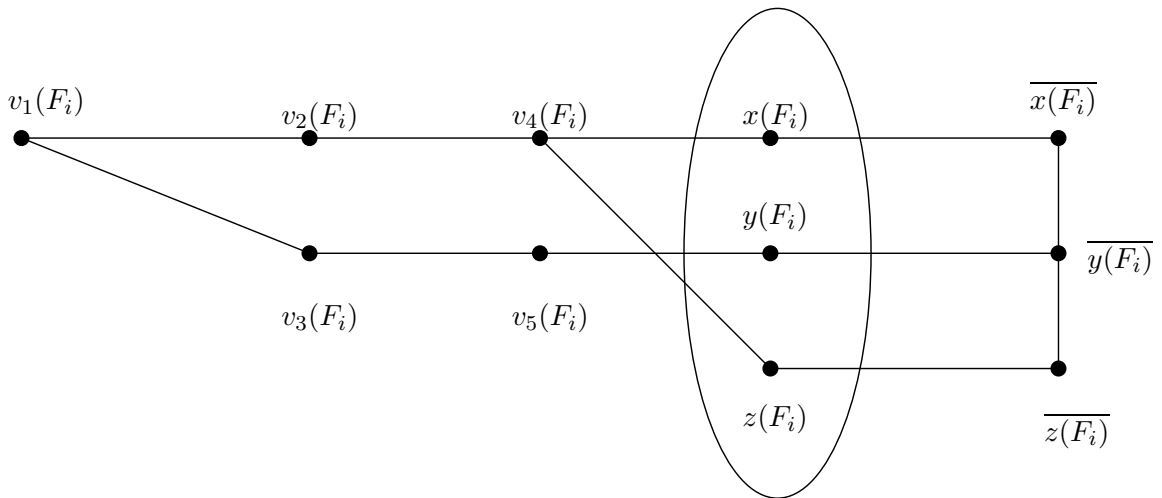

Figure 3: a gadget clause F_i

This graph has 11 nodes $v_1(F_i), \dots, v_5(F_i)$ and $x(F_i), y(F_i), z(F_i), \overline{x(F_i)}, \overline{y(F_i)}, \overline{z(F_i)}$ and 12 edges $\{[v_1(F_i), v_2(F_i)], [v_1(F_i), v_3(F_i)], [v_2(F_i), v_4(F_i)], [v_3(F_i), v_5(F_i)], [v_4(F_i), x(F_i)], [v_4(F_i), z(F_i)],$

$[v_5(F_i), y(F_i)]$ and the edges $\{[x(F_i), \overline{x(F_i)}], [y(F_i), \overline{y(F_i)}], [z(F_i), \overline{z(F_i)}], [\overline{x(F_i)}, \overline{y(F_i)}], [\overline{y(F_i)}, \overline{z(F_i)}]\}$. Moreover, the weights of nodes are one except for $v_1(F_i)$ which is two (i.e., $w(v_1(F_i)) = 2$ and $\forall v \in V(F_i) \setminus \{v_1(F_i)\}, w(v) = 1$).

From the variable x_j , we build the graph H_j described in Figure 4.

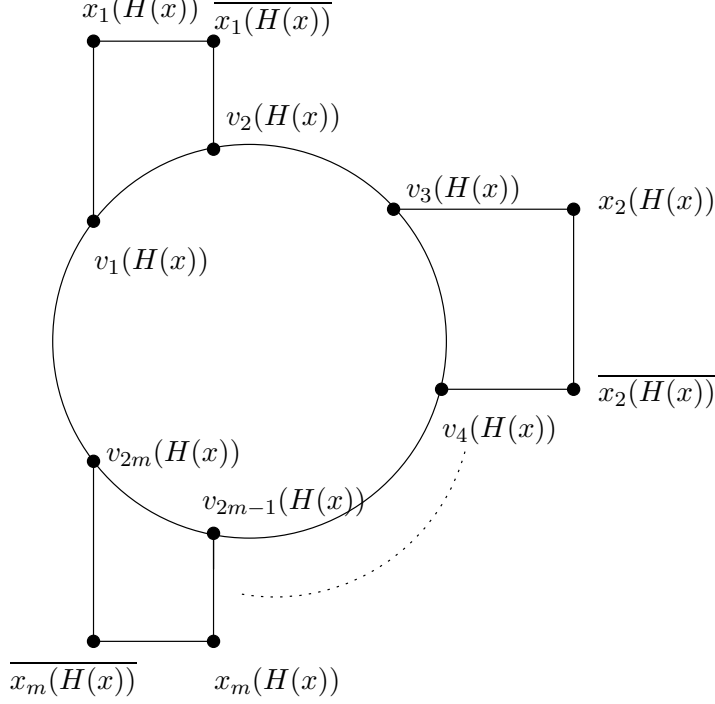

Figure 4: a gadget variable H_j

This graph has $4m$ nodes $x_1(H_j), \dots, x_m(H_j), \overline{x_1(H_j)}, \dots, \overline{x_m(H_j)}$ and $v_1(H_j), \dots, v_{2m}(H_j)$ and $5m$ edges described as follows:

For any $k \leq m$, we have a box on $\{v_{2k-1}(H_j), v_{2k}(H_j), \overline{x_k(H_j)}, x_k(H_j)\}$ described by the edge set $\{[v_{2k-1}(H_j), v_{2k}(H_j)], [v_{2k}(H_j), \overline{x_k(H_j)}], [\overline{x_k(H_j)}, x_k(H_j)], [x_k(H_j), v_{2k-1}(H_j)]\}$.

Moreover, there is a cycle of size $2m$ between the nodes $\{v_1(H_j), \dots, v_{2m}(H_j)\}$ described by the sequence $\{[v_1(H_j), v_2(H_j)], \dots, [v_{2m-1}(H_j), v_{2m}(H_j)], [v_{2m}(H_j), v_1(H_j)]\}$.

Finally, the weights of nodes are one (i.e., $w(z) = 1, \forall z \in V(H_j)$).

In addition, we link these different graphs in the following way:

If the variable x is in the clause C_i then we have:

if $x = x_j$ then we add the edge: $[x_i(H_j), x(F_i)]$

else $x = \overline{x_j}$ then we add the edge: $[\overline{x_i(H_j)}, x(F_i)]$.

This graph G has a maximum degree equal to 3 and the instance $I' = (G, w)$ is computable in polynomial time with respect to n and m .

Let f be a truth assignment of $I = (\mathcal{C}, X)$ (i.e., $f(x_i) = 1$ if $x_i = true$ and $f(x_i) = 0$ if $\overline{x_i} = true$) The hypostable sets S_1 and S_2 of the hypocoloring $\mathcal{S} = (S_1, S_2)$ of I' verifying $\widehat{K}(\mathcal{S}) \leq 3$ are given by:

$$\begin{aligned}
S_1 &= \cup_{i=1}^m [\{v_1(F_i), v_4(F_i), v_5(F_i)\} \cup \{x(F_i) : f(x) = 1\} \cup \{\overline{x(F_i)} : f(x) = 0\}] \\
&\quad \cup_{j=1}^n \cup_{k=1}^m \{x_k(H_j), v_{2k}(H_j) : f(x) = 0\} \\
&\quad \cup_{j=1}^n \cup_{k=1}^m \{\overline{x_k(H_j)}, v_{2k-1}(H_j) : f(x) = 1\} \\
S_2 &= V(G) \setminus S_1
\end{aligned}$$

It is easy to verify that $\mathcal{S} = (S_1, S_2)$ is a hypocoloring and $w(S_1) = 2$ and $w(S_2) = 1$; thus $\widehat{K}(\mathcal{S}) = w(S_1) + w(S_2) = 3$.

Conversely, let \mathcal{S} be a hypocoloring of I' verifying $\widehat{K}(\mathcal{S}) \leq 3$; moreover, assume that $w(S_1) \geq w(S_i)$ for any hypostable set S_i of \mathcal{S} . We exhibit a truth assignment f of I by taking $f(x) = 1$ if and only if $x \in S_1$ (i.e., if $x = x_k$ is in the clause C_i , then we get $f(x) = 1$ else it is $\overline{x_k}$ which is in the clause C_i and we get $f(x) = 1$).

In order to prove this, we shall establish properties of hypocoloring \mathcal{S} :

- (i) $\mathcal{S} = (S_1, S_2)$ and $2 = w(S_1) \geq w(S_2)$.
- (ii) $w(S_2) = 1$ and S_2 is a stable set.
- (iii) $\forall i \leq m, |S_1 \cap \{x(F_i), y(F_i), z(F_i)\}| = 1$.
- (iv) $\forall j \leq n, H_j \cap S_1$ and $H_j \cap S_2$ are stable sets.
- (v) $\forall e = [x_i(H_j), x(F_i)] \in E(G'), x_i(H_j)$ and $x(F_i)$ have two distinct colors.
- (vi) $\forall e = [\overline{x_i(H_j)}, x(F_i)] \in E(G'), \overline{x_i(H_j)}$ and $x(F_i)$ have two distinct colors.

Proof of (i): Assume that $w(S_1) \geq w(S_i)$ for any hypostable S_i of \mathcal{S} ; since $w(S_1) \geq w(v_1(F_1)) = 2$ and the graph G contains an induced P_3 , then we necessarily have $w(S_1) = 2$ (otherwise $\widehat{K}(\mathcal{S}) > 3$). Moreover, since $w(S_i) \geq 1$, we have $S_i = \emptyset$ for $i \geq 3$.

Proof of (ii): Since $w(S_2) \geq 1$ and $\widehat{K}(\mathcal{S}) \leq 3$, we have $w(S_2) = 1$. If S_2 contains at least one edge $e = [x, y]$, we have $w(S_2) \geq w(x) + w(y) \geq 2$, contradiction with the previous statement.

Proof of (iii): From (i), we know that for any $i \leq m$, we have $v_1(F_i) \in S_1$ and $\{v_2(F_i), v_3(F_i)\} \subset S_2$; then, $\{v_4(F_i), v_5(F_i)\} \subset S_1$. Finally, at most one node of $x(F_i), z(F_i)$ belongs to S_1 since otherwise we would have an induced P_3 . If we have $y(F_i) \in S_1$, then $\{x(F_i), z(F_i)\} \cap S_1 = \emptyset$ since otherwise S_2 contains an edge which is a contradiction with claim (ii). We conclude this claim by affirming that $x(F_i), y(F_i), z(F_i)$ can not be simultaneously in S_2 since otherwise $\overline{x(F_i)}, \overline{y(F_i)}, \overline{z(F_i)}$ will be in S_1 .

Proof of (iv): This claim affirms that the gadgets H_j for every $j \leq n$ are always hypocoloring as a simple 2-coloring; by claim (ii), we can observe that the box induce by the nodes $\{v_{2k-1}(H_j), v_{2k}(H_j), \overline{x_k(H_j)}, x_k(H_j)\}$ is necessarily colored in a simple 2-coloring (otherwise S_2 contains an edge which is a contradiction with (ii)). Now, assume that an edge $e = [v_{2k}(H_j), v_{2k+1}(H_j)]$ is in S_1 ; since any box is colored with a 2-coloring and that $v_1(H_j), \dots, v_{2m}(H_j)$ is an even cycle, we necessarily have an edge of this cycle in S_2 , which is still impossible.

Proof of (v): If $x(F_i) \in S_2$, then by (ii) we have $x_i(H_j) \in S_1$ since we have supposed that $e = [x_i(H_j), x(F_i)]$ is an edge in G . Now, if $x(F_i) \in S_1$, then by the proof of (iii), we know that the

nodes $v_4(F_i), v_5(F_i)$ are in S_1 too and, then in F_i , there is an edge adjacent to $x(F_i)$ and belongs to S_1 . Thus, since we have supposed that $e = [x_i(H_j), x(F_i)]$ is an edge in G , we have $x_i(H_j) \in S_2$.

Proof of (vi): Similar to the previous claim.

Finally, from (iii), we know that we have exactly one literal true in each clause. Moreover, the (iii), (iv) and (v) indicate that the function f is a truth assignment. \square

We now prove that, even if the graph G is triangle free and planar with a maximum degree equal to 3, the hypocoloring problem is still **NP-hard**.

Theorem 5.4 *The hypocoloring problem is strongly NP-hard for the triangle free planar graphs with maximum degree 3.*

Proof: In the previous theorem, all gadgets F_i and H_j are planar and then only the edges $[x_l(F_i), x_p(H_j)]$ may create some problems since they may cross each other. In this case, we apply the *crossover* technique (see Garey and Johnson [12]) which consist in replacing each edge crossing by a planar gadget. Since there are only a polynomial number of edge crossings, we obtain a polynomial reduction.

First, we embed the graph G' of theorem 5.3 in the plane in such a way that every edge is a straight line and the crossing edge occurs only between two edges $[x_l(F_i), x_p(H_j)]$. This can be done in polynomial-time.

Second, we replace each crossing edge by the gadget (L, w) described in Figure 5 and we obtain a new graph G'' which is planar, without triangle and with a maximum degree equal to 3.

Finally, we prove that there exists a hypocoloring \mathcal{S} of G' satisfying $\widehat{K}(\mathcal{S}) \leq 3$ if and only if there exist a hypocoloring \mathcal{S}' of G'' satisfying $\widehat{K}(\mathcal{S}') \leq 3$.

For sake of simplicity, we have not explicitly described the vertex set and the edge set of the graph F . However, F contains 8 particular vertices $x_1, x'_1, y_1, y'_1, x_2, x'_2, y_2, y'_2$ and the weight of any vertex is one excepted x'_1, y'_1, x'_2, y'_2 for which is two (i.e., $w(x'_1) = w(y'_1) = w(x'_2) = w(y'_2) = 2$).

Let \mathcal{S} be an hypocoloring of G' (or G'') satisfying $\widehat{K}(\mathcal{S}) \leq 3$; since G' (or G'') contains the previous gadgets, we know that $\mathcal{S} = (S_1, S_2)$ with $w(S_1) = 2$ and $w(S_2) = 1$. Moreover, we have the following properties:

For any hypocoloring $\mathcal{S} = (S_1, S_2)$ satisfying $\widehat{K}(\mathcal{S}) \leq 3$, we have:

- (i) x_1 and x_2 have not the same color.
- (ii) y_1 and y_2 have not the same color.
- (iii) $\{x'_1, x'_2, y'_1, y'_2\} \subseteq S_1$
- (iv) For any $x = x_1, x_2, y_1, y_2$, the neighbors outside of the gadget (L, w) have not the same color as x .

These properties can be easily proved by checking the four cases ($x_1, y_1 \in S_1$ or $x_1 \in S_1$ and $y_1 \in S_2$ or $x_1 \in S_2$ and $y_1 \in S_1$ or $x_1, y_1 \in S_2$).

Finally, from these properties, we deduce that there exists a hypocoloring \mathcal{S} of G' satisfying $\widehat{K}(\mathcal{S}) \leq 3$ if and only if there exists a hypocoloring \mathcal{S}' of G'' satisfying $\widehat{K}(\mathcal{S}') \leq 3$. \square

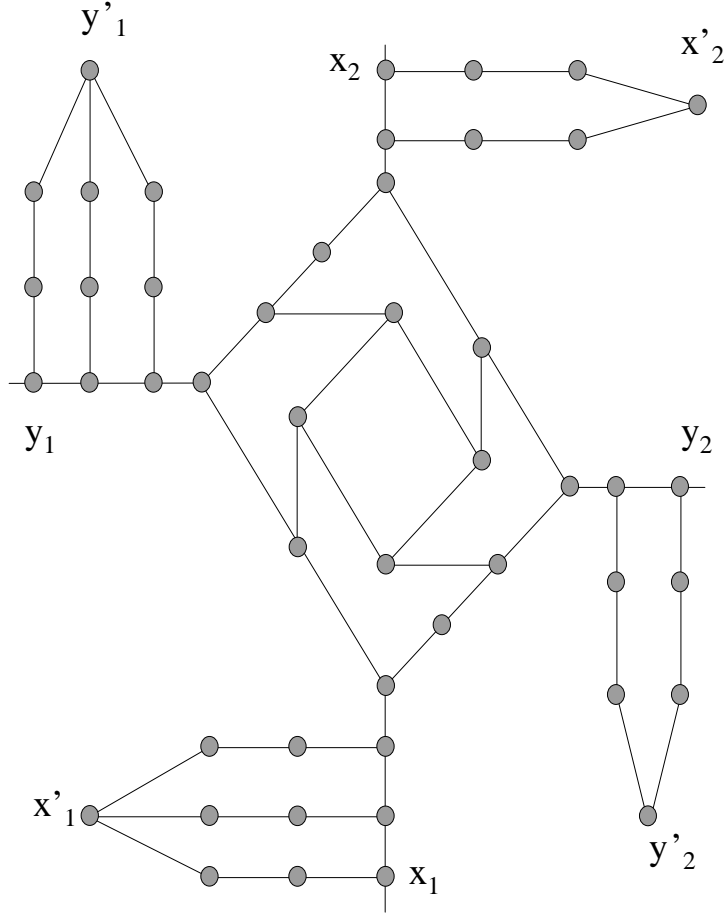

Figure 5: the planar gadget (L, w) .

Now, we deal with the case where the graph is bipartite and the maximum degree bounded above by 39.

Theorem 5.5 *The hypocoloring problem is strongly NP-hard for bipartite graphs with maximum degree at most 39.*

Proof: We polynomially transform the pre-extension coloring problem $1-PrExt$ (proved to be **NP-complete** in Bodlaender et al. [4]) into the hypocoloring problem in bipartite graphs; $1-PrExt$ can be described as follows: given a bipartite graph $G = (V, E)$ with $|V| \geq 3$ and maximum degree equal to 12 and three nodes v_1, v_2, v_3 , does there exist a 3-coloring (S_1, S_2, S_3) of the nodes of G such that $v_i \in S_i$ for $i = 1, 2, 3$?

Let $G = (L, R; E)$ be a bipartite graph where L (resp. R) is the "left set" (resp. "right set") of nodes and each edge has one endpoint in L and the other in R and let v_1, v_2, v_3 be three specific nodes (w.l.o.g. we may assume $\{v_1, v_2, v_3\} \subseteq L$).

We polynomially construct a new bipartite graph G' such that there exists a hypocoloring \mathcal{S} of G' with $\widehat{K}(\mathcal{S}) \leq 7$ if and only if there exists a 3-coloring (S_1, S_2, S_3) of G with $v_i \in S_i$, $i = 1, 2, 3$.

In order to do that, we use the two following gadgets:

- The bipartite graph $H_0 = (L_0, R_0; E_0)$ where $L_0 = \{l_1, l'_1, l_2, l'_2, l_3\}$ and $R_0 = \{r_1, r'_1, r_2, r'_2, r_3\}$ and the edges are for any $1 \leq i \leq 3$, $[l_i, y], [l'_i, y]$ for $y \in R_0 \setminus \{r_i, r'_i\}$. Finally, we get $w(l_i) = w(l'_i) = w(r_i) = w(r'_i) = 2^{3-i}$ for $i = 1, 2, 3$. This graph is described in Figure 6.

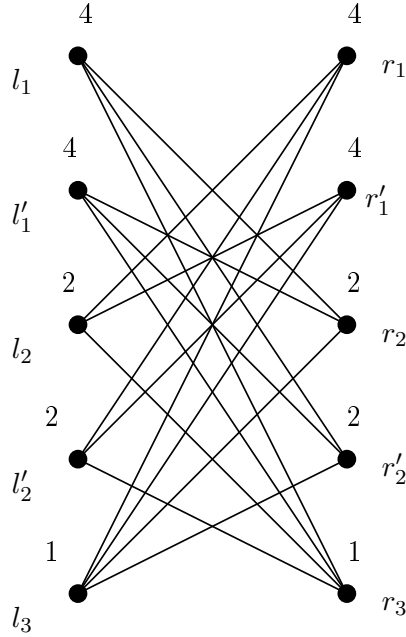

Figure 6: the gadget H_0 .

- The complete bipartite graph $K_{3,2}$ where one node x of the left set and one node of the right set y are specified. The weights are $w(x) = w(y) = 1$ and $w(v) = 2$ otherwise.

Now, the instance $I = (G', w)$ of hypocoloring is built in the following way: Starting from G , we add a copy of H_0 and we identify nodes v_1, v_2, v_3 of G with nodes l_1, l_2, l_3 of H_0 . Moreover, for each edge $e = [l, r]$ of G , we introduce a copy of $K_{3,2}$ and we identify nodes l, r with nodes x_e, y_e respectively. We call this graph H_e where L_e and R_e denote respectively, the left and right sets. This gadget is described in Figure 7.

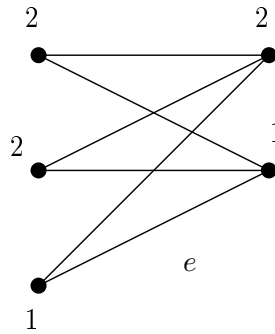

Figure 7: the gadget H_e .

Note that G' is still bipartite and its maximum degree is bounded above by 39 ($\Delta(G') \leq 3\Delta(G) + 3 = 39$).

Let (S_1, S_2, S_3) be a 3-coloring of G with $v_i \in S_i$, $i = 1, 2, 3$; then we get a hypocoloring \mathcal{S}' of the nodes of G' by applying the following process:

We start with $S'_i = (S_i \setminus \{v_i\}) \cup \{l_i, l'_i\}$ for $i = 1, 2, 3$ and for each edge $e = [l, r]$ of G with $l \in L$ and $r \in R$, we do:

- If $l \in S_j$ with $j = 1, 2$ then we take $S'_j = S'_j \cup (L_e \setminus \{x_e\})$
- If $r \in S_j$ with $j = 1, 2$ then we take $S'_j = S'_j \cup (R_e \setminus \{y_e\})$
- If $l \in S_3$ and $r \in S_j$ with $j = 1, 2$ then we take $S'_{3-j} = S'_{3-j} \cup (L_e \setminus \{x_e\})$
- If $r \in S_3$ and $l \in S_j$ with $j = 1, 2$ then we take $S'_{3-j} = S'_{3-j} \cup (R_e \setminus \{y_e\})$

\mathcal{S}' is a coloring of G' (thus a hypocoloring) and verifies $\widehat{K}(\mathcal{S}') = w(S'_1) + w(S'_2) + w(S'_3) = 7$.

Conversely assume G' has a k -hypocoloring $\mathcal{S}' = (S'_1, \dots, S'_k)$ verifying $\widehat{K}(\mathcal{S}') \leq 7$. Moreover, suppose that we have ordered the hypostable sets in such way that $w(S'_1) \geq \dots \geq w(S'_k)$; we deduce the following properties:

- (i) $\{l_1, l'_1, r_1, r'_1\} \subseteq S'_1$ and $\{l_1, l'_1, r_1, r'_1\}$ is a stable set of S'_1 (i.e., in the subgraph induced by S'_1 , they are isolated nodes).
- (ii) $\{l_2, l'_2, r_2, r'_2\} \subseteq S'_2$ and $\{l_2, l'_2, r_2, r'_2\}$ is a stable set of S'_2 (i.e., in the subgraph induced by S'_2 , they are isolated nodes).
- (iii) $k = 3$ and $w(S'_1) = 4$, $w(S'_2) = 2$, $w(S'_3) = 1$.
- (iv) $\{l_3, r_3\} \subseteq S'_3$ and S'_3 is a stable set of G' .

Proof of (i): By construction, $w(S'_1) \geq 4$ and we have $\{l_1, l'_1, r_1, r'_1\} \subseteq S'_1$ since otherwise $\widehat{K}(\mathcal{S}') \geq w(S'_1) + 4 \geq 8$. Assume that there exists $x \in S'_1$ and $y \in \{l_1, l'_1, r_1, r'_1\}$ such that $[x, y] \in E$. By symmetry of H_0 , we can suppose $y = l_1$; since G' contains no triangle and the edge $[x, l'_1] \in E$, we conclude that $l'_1 \notin S'_1$, which gives a contradiction.

Proof of (ii): From the definition of hypostable and for (i), we deduce $\{l_2, l'_2, r_2, r'_2\} \cap S'_1 = \emptyset$. So, $w(S'_2) \geq 2$; if $\{l_2, l'_2, r_2, r'_2\} \not\subseteq S'_2$, then $\widehat{K}(\mathcal{S}') \geq w(S'_1) + w(S'_2) + 2 \geq 8$ which is impossible. Next, as for (i), we can prove that these nodes form a stable set in the subgraph induced by S'_2 and then, $l_3 \notin S'_1 \cup S'_2$ and $r_3 \notin S'_1 \cup S'_2$; we deduce that $S'_3 \neq \emptyset$.

Proof of (iii): From the previous remark, we have $w(S'_3) \geq 1$ and if $S'_4 \neq \emptyset$ or $w(S'_1) \neq 4$ or $w(S'_2) \neq 2$ or $w(S'_1) \neq 1$, then we have $\widehat{K}(\mathcal{S}') \geq 8$ which is impossible.

Proof of (iv): We necessarily have $\{l_3, r_3\} \subseteq S'_3$; moreover, S'_3 contains only nodes of weight one. Now, assume that S'_3 is not a stable set, we will have $w(S'_2) \geq 2$ and it is in contradiction with (iii).

We want to prove that $(S_1, S_2, S_3) = (S'_1 \cap V, S'_2 \cap V, S'_3 \cap V)$ is a 3-coloring of G with $l_i \in S_i$; let us suppose the contrary, there will exist an edge $e = [r, l] \in E$ with $\{l, r\} \subseteq S'_j$ and $j = 1$ or 2 (since S'_3 is a stable set, see (iv)); Since the subgraph induced by $L_e \cup R_e$ is hypocolorized with at

most three colors, we have by construction of H_e , $S'_j \cap (L_e \setminus \{l\}) = \emptyset$ and $S'_j \cap (R_e \setminus \{r\}) = \emptyset$. Then, since $(L_e \cup R_e) \setminus \{l, r\}$ must be hypocolored with at least two colors and the cost of these nodes are two, we deduce that S'_3 contains a node of weight two, which is impossible. Finally, (i), (ii) and (iv) indicate that $l_i \in S_i$ which concludes the proof. \square

6 Approximability of some cases of hypocoloring.

We use two approximation-quality criteria called in what follows *standard approximation ratio* and *differential approximation ratio*, respectively. Consider an instance I of an **NP**-hard optimization problem Π and a polynomial time approximation algorithm **A** solving Π ; we will denote by $\text{worst}(I)$, $\text{val}_A(I)$ and $\text{opt}(I)$ the values of the worst solution of I , of the approximated one (provided by **A** when running on I), and the optimal one for I , respectively. If Π is a minimization problem, the value $\text{worst}(I)$ is in fact the optimal solution of a maximization problem Π' having the same objective function and the same constraint set as Π . Let us note that computation of the solution realizing $\text{worst}(I)$ can be easy for some **NP**-hard problems (this is the case of graph coloring) but for other ones (for example, for traveling salesman, or for optimum satisfiability, or for minimum maximal independent set) this computation is **NP**-hard. Commonly, the quality of an approximation algorithm for Π is expressed by the ratio (called standard in what follows) $\rho_A(I) = \text{val}_A(I)/\text{opt}(I)$, and the quantity $\rho_A = \sup\{r : \rho_A(I) \geq r, I \text{ instance of } \Pi\}$, if Π is a minimization problem constitutes the approximation ratio of **A** for Π . On the other hand, the differential approximation ratio measures how the value of an approximate solution is placed in the interval between $\text{worst}(I)$ and $\text{opt}(I)$. More formally, it is defined as $\delta_A(I) = |\text{worst}(I) - \text{val}_A(I)|/|\text{worst}(I) - \text{opt}(I)|$. The quantity $\delta_A = \inf\{r : \delta_A(I) \leq r, I \text{ instance of } \Pi\}$ is the differential approximation ratio of **A** for Π . A very optimistic configuration for both standard and differential approximations is the one where an algorithm achieves ratios bounded below by $1 - \epsilon$ ($1 + \epsilon$ for the standard approximation for minimization problems), for any $\epsilon > 0$. We call such algorithms *polynomial time approximation schemes*. The complexities of such schemes may be polynomial or exponential in $1/\epsilon$ (they are always polynomial in the sizes of the instances). A polynomial time approximation scheme with complexity also polynomial in $1/\epsilon$ is called *fully polynomial time approximation scheme*.

We shall present here approximation algorithms for hypocolorings in some special classes of graphs. More specifically, we are interested in a class of graphs for which the coloring problem is easy and the chromatic number is small; formally, we denote by Ψ_k a class of graphs verifying: (i) $\forall G' \subseteq G$ if $G \in \Psi_k$, then $G' \in \Psi_k$, (ii) $\forall G \in \Psi_k$, $\chi(G) \leq k$ and (iii) coloring on Ψ_k -graphs is polynomial.

For instance, the set of forests is a Ψ_2 -class.

Let Ψ_k be a class of graphs described above such that the hypocoloring problem is **NP-hard** (in particular, we have $k \geq 2$). $I = (G, w)$ will be an instance of hypocoloring where $G \in \Psi_k$ and assume that the nodes are ordered according to their non-increasing weights $w(v_1) \geq \dots \geq w(v_n)$. Moreover, we can always suppose that $w(v) > 0$, $\forall v \in V$ (by deleting the nodes v with $w(v) = 0$).

We also denote by G_i the subgraph induced by the node set $\{v_1, \dots, v_i\} = V_i$ and by j_0 the

smallest index i such that G_i contains an induced P_3 . When $G_n = G$ does not contain an induced P_3 , we set $j_0 = n + 1$. Finally, we denote by $\mathcal{C}(V')$ an optimal coloring of the subgraph of G induced by V' .

6.1 Standard approximation.

A trivial bound of the standard approximability on Ψ_k -graphs is k and consists of computing $\mathcal{C}(V)$ in a whole graph (in other words, we just compute an optimal coloring). We now propose a polynomial time approximation algorithm achieving a better constant standard approximation ratio for this class of graphs. This algorithm, denoted by $\Psi_k\text{-HYPOCOLOR}$ works as follows:

1. Sort the nodes of G in non-increasing weight order;
2. Compute $j_0 = \min\{i : G_i \text{ contains an induced } P_3\}$ and $V_{j_0} = \{v_1, \dots, v_{j_0}\}$;
3. For $i = 1$ to j_0 do
 - (a) $S_1^i = V_{j_0} \setminus \{v_i, \dots, v_{j_0}\}$;
 - (b) Compute $\mathcal{C}(V \setminus S_1^i)$ (i.e. an optimal coloring on the unweighted graph induced by $V \setminus S_1^i$);
 - (c) Define hypocoloring $\mathcal{S}^i = (S_1^i, \mathcal{C}(V \setminus S_1^i))$;
4. Compute $\mathcal{S} = \operatorname{argmin}\{\widehat{K}(\mathcal{S}^i) : i = 1, \dots, j_0\}$;

We can easily observe that each hypocoloring \mathcal{S}^i is feasible and that its number of colors is at most $k + 1$. So, the algorithm $\Psi_k\text{-HYPOCOLOR}$ is correct and its time-complexity is similar to the one of computing an optimal coloring on Ψ_k -graphs times n .

Theorem 6.1 *Algorithm $\Psi_k\text{-HYPOCOLOR}$ polynomially solves hypocoloring in Ψ_k -graphs within standard approximation ratio bounded above by $\frac{k^2}{2k-1}$.*

Proof: Let $G = (V, E)$ be a weighted Ψ_k -graph and $\mathcal{S}^* = (S_1^*, \dots, S_\ell^*)$ be an optimal hypocoloring of $I = (G, w)$ with $w(S_1^*) \geq \dots \geq w(S_\ell^*)$. If $\ell = 1$, then $j_0 = n + 1$ and the solution \mathcal{S} computed by $\Psi_k\text{-WHYPOCOLOR}$ verifies $\widehat{K}(\mathcal{S}) \leq \widehat{K}(\mathcal{S}^{j_0}) = \widehat{K}(\mathcal{S}^*)$. So, assume that $j_0 \leq n$; denote by S_i the set $S_1^* \cap V_i$ for any $i \leq j_0$.

If $S_1 = \emptyset$ then $\widehat{K}(\mathcal{S}^*) \geq 2w_{max}$ and $\widehat{K}(\mathcal{S}) \leq \widehat{K}(\mathcal{S}^1) \leq k w_{max}$. Thus, we have $\widehat{K}(\mathcal{S}) \leq \frac{k}{2}\widehat{K}(\mathcal{S}^*)$.

If $S_1 \neq \emptyset$ then we obtain $S_1 = V_1$; on the other hand, we also have $S_{j_0} \neq V_{j_0}$ since V_{j_0} is not an hypostable set. Thus, the item $i_0 = \max\{i : S_i = V_i\}$ exists and verifies $i_0 < j_0 \leq n$. Now, we are interested in the solution $\mathcal{S}^{i_0} = (S_1^{i_0}, \dots, S_{k+1}^{i_0})$; by construction, we have: $w(S_1^{i_0}) \geq \dots \geq w(S_{k+1}^{i_0})$.

If $w(S_2^{i_0}) \leq w(S_1^{i_0})\frac{k-1}{k}$, then For $r \geq 3$,

$$w(S_r^{i_0}) \leq \frac{k-1}{2k-1}(w(S_2^{i_0}) + \frac{k}{2k-1}w(S_2^{i_0})) \leq \frac{k-1}{2k-1}(w(S_1^{i_0}) + w(S_2^{i_0}))$$

So, summing up these inequalities, we deduce:

$$w(S_3^{i_0}) + \dots + w(S_{k+1}^{i_0}) \leq \frac{(k-1)^2}{2k-1}(w(S_1^{i_0}) + w(S_2^{i_0}))$$

Hence

$$\widehat{K}(\mathcal{S}^{i_0}) \leq \left(\frac{(k-1)^2}{2k-1} + 1\right)(w(S_1^{i_0}) + w(S_2^{i_0})) = \frac{k^2}{2k-1}(w(S_1^{i_0}) + w(S_2^{i_0})) \quad (6.1)$$

Since $\widehat{K}(\mathcal{S}^*) \geq w(S_1^{i_0}) + w(S_2^{i_0})$ from the choice of i_0 and from the fact that $S_2^{i_0}$ is a stable set ($w(S_2^{i_0})$ is the maximum weight of the nodes in $V \setminus S_1^{i_0}$) the result follows.

If $w(S_2^{i_0}) \geq w(S_1^{i_0}) \frac{k-1}{k}$, then $\widehat{K}(\mathcal{S}^*) \geq w(S_1^{i_0}) \frac{2k-1}{k}$ and we have:

$$\widehat{K}(\mathcal{S}) \leq \widehat{K}(\mathcal{S}^1) = w(\mathcal{C}(V)) \leq k w(S_1^{i_0}) \leq \frac{k^2}{2k-1} \widehat{K}(\mathcal{S}^*)$$

Finally, since $\frac{k^2}{2k-1} \geq \frac{k}{2}$, we obtain the expected result. \square

For the graphs with maximum degree 3, we have the corollary:

Corollary 6.2 *There exists a $\frac{9}{5}$ -standard approximation for the hypocoloring problem in graphs with maximum degree at most 3.*

Proof: We can assume that G does not contain any copy of K_4 , since in time at most $O(n^4)$, we can precolor the nodes of the K_4 with the same colors as in optimal hypocoloring. Thus, by Brooks' theorem we deduce $\chi(G) \leq 3$. Moreover in this case, we can compute in polynomial-time an optimal coloring. Thus, these graphs are a Ψ_3 -class and we can apply Theorem 6.1. \square

Corollary 6.3 *There exists a $\frac{9}{5}$ -standard approximation for the hypocoloring problem in triangle free planar graphs.*

Proof: From Grotzsch's theorem [13], we know that the coloring problem is easy for triangle free planar graphs. Thus, since $\chi(G) \leq 3$ when G is triangle free planar, we deduce that triangle free planar graphs forms a Ψ_3 -class, and then we can apply Theorem 6.1. \square

The bipartite graphs are also a special case of Ψ_2 -class and then, we have:

Corollary 6.4 *There exists a $\frac{4}{3}$ -standard approximation for the hypocoloring problem in bipartite graphs.*

On the other hand, we can also establish a bound on the standard approximability of these two types of graphs.

Examine first the proof of Theorem 5.4, consider a triangle-free planar graph G . Remember that $\widehat{K}(\mathcal{S}^*) \leq 3$ iff the answer for $1 - IN\ 3SAT$ is *yes*. Assume now that there exists a polynomial time approximation algorithm A achieving, for some $\epsilon_0 > 0$, an approximation ratio $(4/3) - \epsilon_0$.

- If $\widehat{K}(\mathcal{S}^*) \leq 3$ (the answer for $1 - IN\ 3SAT$ in $I = (\mathcal{C}, X)$ is *yes*), then $\text{val}_A(G) = 4 - 3\epsilon_0$ and, since val has to be integer, $\text{val}_A(G) = 3$;
- on the other hand, if $\widehat{K}(\mathcal{S}^*) \geq 4$, i.e., the answer for $1 - IN\ 3SAT$ in $I = (\mathcal{C}, X)$ is *no*, then $\text{val}_A(G) \geq \widehat{K}(\mathcal{S}^*) \geq 4$.

Consequently, with the hypothesis that a polynomial time approximation algorithm A achieves, for some $\epsilon_0 > 0$, approximation ratio $(4/3) - \epsilon_0$ for hypocoloring, one can in polynomial time decide on the right answer for $1 - IN\ 3SAT$ by simply reading the value of the solution computed by A . The following proposition summarizes the above discussion.

Proposition 6.5 *Unless $P = NP$, for any $\epsilon > 0$ no polynomial time algorithm achieves an approximation ratio bounded above by $(4/3) - \epsilon$ for the hypocoloring problem in triangle-free planar graphs with maximum degree bounded above by 3.*

By the same type of proof and from theorem 5.5, we can also show:

Proposition 6.6 *Unless $P = NP$, for any $\epsilon > 0$ no polynomial time algorithm achieves an approximation ratio bounded above by $(8/7) - \epsilon$ for the hypocoloring problem in bipartite graphs with maximum degree bounded above by 39.*

We end this subsection by proposing another simple approximation algorithm which works for any value of $\Delta(G)$. This algorithm uses a decomposition of G into at most $s = \lceil \frac{\Delta(G)+1}{3} \rceil$ subgraphs G_i satisfying $\Delta(G_i) \leq 2$ by applying a result of Lovász [15]. Then, for each $i = 1, \dots, s$, we compute an optimum hypocoloring \mathcal{S}_i^* on G_i by using the algorithm presented in Subsection 7.2 (Proposition 7.18) and we color the corresponding solution with new colors. Finally, the solution \mathcal{S} is the juxtaposition of these hypocolorings \mathcal{S}_i^* .

Theorem 6.7 *The hypocoloring problem is $\lceil \frac{\Delta(G)+1}{3} \rceil$ -standard approximable.*

Proof: We have $\widehat{K}(\mathcal{S}) = \sum_{i=1}^s \widehat{K}(\mathcal{S}_i^*)$ and $\widehat{K}(\mathcal{S}^*) \geq \widehat{K}(\mathcal{S}_i^*)$ for any $i = 1, \dots, s$. Then, $\widehat{K}(\mathcal{S}) \leq s \times \widehat{K}(\mathcal{S}^*)$. \square

6.2 Differential approximation.

We now show that in the Ψ_k -graphs, there is a differential approximation scheme. Assume that $G = (V, E) \in \Psi_k$ and consider then the following algorithm, called Ψ_k -Hypo_SCHEME in what follows and run it with parameters G and a fixed constant $\epsilon > 0$:

1. Sort the nodes of G in non-increasing weight order;
2. Set $\eta = \lceil 1/\epsilon \rceil$;
3. Compute an optimal hypocoloring $\tilde{\mathcal{S}}$ of the graph induced by $V_{2k\eta+k}$;
4. Compute an optimal coloring $\mathcal{C}(V_{2k\eta+k})$ of the subgraph induced by $V \setminus V_{2k\eta+k}$;
5. Set $\mathcal{S} = (\tilde{\mathcal{S}}, \mathcal{C}(V_{2k\eta+k}))$;

Since η and k are fixed constants, the set $\tilde{\mathcal{S}}$ of step 3 of algorithm Ψ_k -Hypo_SCHEME can be computed by an exhaustive search in constant time. Consequently, the whole complexity of Ψ_k -Hypo_SCHEME is linear in n .

Theorem 6.8 *For any fixed $\epsilon > 0$, the differential approximation ratio of Ψ_k -Hypo_SCHEME when called with inputs $G \in \Psi_k$ and ϵ , is bounded below by $1 - \epsilon$.*

Proof: Let $G = (V, E)$ be a weighted Ψ_k -graph and $\mathcal{S}^* = (S_1^*, \dots, S_l^*)$ be an optimal hypocoloring of $I = (G, w)$ with $w(S_1^*) \geq \dots \geq w(S_l^*)$. We first show that the number of hypostable sets of $\tilde{\mathcal{S}}$ is not very large and that $\widehat{K}(\mathcal{S}^*) \geq \widehat{K}(\tilde{\mathcal{S}})$.

claim (i): $|\tilde{\mathcal{S}}| \leq k(\eta + 1)$

Proof of claim (i): We denote by \tilde{V}_1 the node set formed by the union of hypostable sets of $\tilde{\mathcal{S}}$ having their number of connected components equal to one; so, the graph \tilde{G}_1 induced by \tilde{V}_1 is a union of disjoint cliques plus eventually some edges between these cliques. We affirm that \tilde{G}_1 has at most k nodes; by construction, the weight of these hypostable sets is $w(\tilde{V}_1) = \sum_{v \in \tilde{V}_1} w(v)$ and if $|\tilde{V}_1| > k$, then an optimal coloring of \tilde{G}_1 gives a better value (since $\tilde{G}_1 \in \Psi_k$) which is impossible; thus, we have: $|\tilde{\mathcal{S}}| \leq (|V_{2k\eta+k} \setminus \tilde{V}_1|)/2 + |\tilde{V}_1| = (2k\eta)/2 + k$.

claim (ii): $\widehat{K}(\mathcal{S}^*) \geq \widehat{K}(\tilde{\mathcal{S}})$

Proof of claim (ii): We take the hypocoloring \mathcal{S}' of the subgraph induced by $V_{2k\eta+k}$ which is the restriction of the hypocoloring \mathcal{S}^* (i.e., $\mathcal{S}' = (S_1^* \cap V_{2k\eta+k}, \dots, S_l^* \cap V_{2k\eta+k})$). Since the criterion is maximum, we have: $\widehat{K}(\mathcal{S}^*) \geq \widehat{K}(\mathcal{S}')$; on the other hand, since the property of hypocoloring is hereditary, we also have $\widehat{K}(\tilde{\mathcal{S}}) \leq \widehat{K}(\mathcal{S}')$ and the result follows.

Now, since $wor(G_{2k\eta+k}) = \sum_{v \in V_{2k\eta+k}} w(v)$ and by inequality of claim (i) and the fact that the nodes of G are sorted in non-increasing weight order, we have: $wor(G_{2k\eta+k}) - \widehat{K}(\tilde{\mathcal{S}}) \leq (k\eta) \times w(v_{2k\eta+k})$. Moreover, since $\eta \geq 1/\epsilon$, we obtain:

$$\epsilon \left(wor(G_{2k\eta+k}) - \widehat{K}(\tilde{\mathcal{S}}) \right) \geq k \times w(v_{2k\eta+k}) \quad (6.2)$$

Finally, by claim (ii) and since $wor(G_{2k\eta+k}) \leq wor(G)$, the solution \mathcal{S} produced by the algorithm Ψ_k -Hypo_SCHEME verifies $w(\mathcal{C}(V_{4\eta+k})) \leq kw(v_{4\eta+k})$ ($\chi(G) \leq k$ since $G \in \Psi_k$) and by inequality (6.2), we have:

$$\widehat{K}(\mathcal{S}) = \widehat{K}(\tilde{\mathcal{S}}) + w(\mathcal{C}(V_{4\eta+k})) \leq (1 - \epsilon)\widehat{K}(\tilde{\mathcal{S}}) + \epsilon wor(G_{2k\eta+k}) \leq (1 - \epsilon)\widehat{K}(\mathcal{S}^*) + \epsilon wor(G)$$

□

We note finally that with exactly the same arguments as for the proofs of Proposition 6.6 and Proposition 6.5 and taking into account that $wor(G) - \widehat{K}(\mathcal{S}^*) \leq P(n)$ for some polynomial P , one can conclude that, unless $\mathbf{P} = \mathbf{NP}$, no polynomial time algorithm can achieve a differential approximation ratio greater than $1 - \frac{1}{P(n)}$, and the following holds.

Proposition 6.9 *Unless $\mathbf{P} = \mathbf{NP}$, if the hypocoloring problem is strongly **NP-hard** on a Ψ_k -class, then the hypocoloring problem cannot be solved in a Ψ_k -class by a fully polynomial time differential approximation scheme.*

This is the case for the triangle-free graphs with maximum degree equal to 3 and for the bipartite graphs.

7 Polynomial cases

In this section, we consider two polynomial cases of the weighted hypocoloring problem: when the input is a collection of disjoint trees with maximum degree at most Δ and when the input is a collection of disjoint cycles. The first case is equivalent to solve hypocoloring in trees with degree at most Δ whereas the second case is equivalent to solve hypocoloring in graphs with degree at most 2, as we will be shown later. Thus, since a tree is a particular bipartite graph, we have a frontier for the hardness of the hypocoloring problem between trees with maximum degree at most 39 and bipartite graphs with maximum degree at most 39; the first case will be shown to be polynomial in the next subsection whereas the bipartite case has been shown to be strongly **NP-hard** (see proposition 5.5). Finally, we will see that there is also another hardness gap for general graphs between graphs with maximum degree at least 3 and graphs with maximum degree at most 2.

Before establishing these results, we shall give some results on hypocolorings in $(r + 1)$ -clique free graphs. For a hypostable set S , the *characteristic value* will be the integer number q such that $q = w(S)$. Since we are in $(r + 1)$ -clique free graphs, there are at most $O(n^r)$ possible characteristic values of the different hypostable sets. More generally, for a hypocoloring $\mathcal{S} = (S_1, \dots, S_k)$ with $w(S_1) \geq \dots \geq w(S_k)$ we call *vector of characteristic values*, the vector (q_1, \dots, q_k) such that for any $i \leq k, q_i = w(S_i)$. In $(r + 1)$ -clique free graphs, given a vector (q_1, \dots, q_k) with $q_1 \geq \dots \geq q_k$, the problem of deciding if there is a hypocoloring \mathcal{S}' whose vector of characteristic values (q'_1, \dots, q'_k) verifies for any $i, q'_i \leq q_i$ can be polynomially reduced to the *list-hypocoloring_r problem* as will be shown below. This latter problem is formally described by the following:

list-hypocoloring_r:

Instance: a graph $G = (V, E)$, a set \mathcal{C} of colors and, for every clique K with size at most $r, C_K \subseteq \mathcal{C}$ is a set of colors such that each one of them may occur on some nodes of the clique K but not on all nodes at a time.

Question: does G admit a hypocoloring such that for any clique K , not all the nodes of K have the same color i with $i \in C_K$?

Remark 7.1 *Clearly, we must have C_K contained in $C_{K'}$ when $K \subseteq K'$. Moreover, the problem list-hypocoloring_r polynomially reduces to the problem list-hypocoloring_{r'} when $r \leq r'$.*

Remark 7.2 *Note that when list-hypocoloring_r is polynomial for a class Ψ of $(r + 1)$ -clique free graphs then, the related problem of constructing such a hypocoloring is polynomial. Let $I = (G, C_K)$ be an instance of list-hypocoloring_r. In order to do that, we find a r -clique K of G such that $C_K \neq \mathcal{C}$. Let $i \notin C_K$ and denote by G' the subgraph of G induced by $V \setminus V(K)$; we color K with color i and for each node v of G' which is adjacent to a node of K , we set $C_v = C_v \cup \{i\}$ and more generally for each clique K of G' containing v , we set (see remark 7.1) $C_K = C_K \cup \{i\}$. Let I' be the resulting instance. If the answer of list-hypocoloring_r on instance I' is yes, we apply again this procedure on I' else we set $C_K = C_K \cup \{i\}$ and we apply again this procedure on I . Finally, when $C_K = \mathcal{C}$ for every r -clique K of G , we apply the same procedure with $(r - 1)$ -cliques and so on.*

For every clique K of G , we denote by $w(K)$ the quantity $\sum_{v \in K} w(v)$. Let (q_1, \dots, q_k) with $q_1 \geq \dots \geq q_k$ be a vector. Since G is $(r + 1)$ -clique free, each hypostable set is a union of disjoint cliques with size at most r , we can polynomially construct an instance of $\text{list-hypocoloring}_r$ in the following way: the graph G is the same, $\mathcal{C} = \{1, \dots, k\}$ and for any clique K of G , $C_K = \{i \in \mathcal{C} : q_i < w(K)\}$. Assume that the answer of the $\text{list-hypocoloring}_r$ instance is yes and let $\mathcal{S}' = (S'_1, \dots, S'_k)$ with $w(S'_1) \geq \dots, w(S'_k)$ (some S'_i can be empty) be such a hypocoloring. Let K be a clique of S'_i ; by construction $w(K) \leq q_i$ since $i \notin C_K$ and then, $q'_i = w(S'_i) \leq q_i$. Conversely, if such a hypocoloring exists then, the answer of the $\text{list-hypocoloring}_r$ instance is yes. So, we have proved the result claimed.

In the graphs with maximum degree Δ (which is a subclass of $(\Delta + 2)$ -clique free graphs), we now prove that hypocoloring polynomially reduces to $\text{list-hypocoloring}_{\Delta+1}$.

Proposition 7.3 *The hypocoloring problem for graphs of degree at most Δ polynomially reduces to the $\text{list-hypocoloring}_{\Delta+1}$ problem.*

Proof: Let (G, w) be a weighted graph with maximum degree Δ , a minimum hypocoloring can be computed by the following algorithm:

1. For every vector (q_1, \dots, q_Δ) with $q_1 \geq \dots \geq q_\Delta$ and such that $q_i = w(K_i)$ for some clique K_i of G do:
 - (a) Solve the related $\text{list-hypocoloring}_{\Delta+1}$ instance ;
 - (b) If the answer is yes, construct such a hypocoloring ;
2. Select a minimum weight hypocoloring among feasible hypocolorings computed during an execution of step (1b) ;

The complexity-time of this algorithm is $O(n^{\Delta^2} \times C(n))$ where $C(n)$ is the complexity-time to solve the $\text{list-hypocoloring}_{\Delta+1}$ problem. Since G admits a minimum hypocoloring with at most Δ colors (see proposition 4.2), let $\mathcal{S}^* = (S_1^*, \dots, S_\Delta^*)$ with $w(S_1^*) \geq \dots, w(S_\Delta^*)$ be an optimal hypocoloring (with possibly some $S_i^* = \emptyset$) and denote by $(q_1^*, \dots, q_\Delta^*)$ its vector of characteristic values. Let us examine the step of algorithm with the vector $(q_1^*, \dots, q_\Delta^*)$. By construction, the answer of the $\text{list-hypocoloring}_{\Delta+1}$ instance is yes and the algorithm finds a hypocoloring $\mathcal{S}' = (S'_1, \dots, S'_\Delta)$ verifying $w(S'_i) \leq q_i^*$ and then, $w(S'_i) = q_i^*$ since $(q_1^*, \dots, q_\Delta^*)$ is a vector of characteristic values of an optimal hypocoloring. \square

Corollary 7.4 *Let us consider a class Ψ of graphs of degree bounded above by Δ such that $\text{list-hypocoloring}_{\Delta+1}$ is polynomial on Ψ . Then, the minimum hypocoloring problem is also polynomial on Ψ .*

Since we have proved in theorem 5.4 and theorem 5.5 that the hypocoloring problem is **NP-hard** in bipartite graphs with maximum degree 39 and planar triangle-free graphs with maximum degree 3 respectively, we deduce the two following corollaries:

Corollary 7.5 For any $r \geq 40$, list-hypocoloring $_r$ in bipartite graphs of degree 39 is **NP-complete**.

Corollary 7.6 For any $r \geq 4$, list-hypocoloring $_r$ in planar triangle-free graphs of degree 3 is **NP-complete**.

7.1 Trees with maximum degree Δ

In trees, there are at most $2n - 1$ characteristic values for the different hypostable sets. Thus, the algorithm of proposition 7.3 is in this case in $O(n^\Delta)$ times the complexity-time of the list-hypocoloring $_{\Delta+1}$. We now show that we can solve the list-hypocoloring $_{\Delta+1}$ problem in trees by using dynamic programming.

Let $\mathcal{C} = \{1, \dots, \Delta\}$ be the set of colors. Let us then consider $(T = (V, E); (C_K)_{K \in V \cup E})$ an instance of list-hypocoloring $_{\Delta+1}$ where T is a tree. Given a node v , we respectively denote by $H_v(T)$ and $H'_v(T)$ the sets of colors defined by:

$h \in H_v(T)$ (resp. $H'_v(T)$) if and only if there is a feasible hypocoloring for which v is colored by h and no (resp. exactly one) neighbor of v is colored by h .

We denote by v_1, \dots, v_d the neighbors of v . The deletion of v induces a forest with d connected components ; let $T_i, i = 1, \dots, d$ denote the subtree containing v_i . The following lemma can then be easily shown:

Lemma 7.7 For $h \in \mathcal{C}$, we have:

$$h \in H_v(T) \Leftrightarrow \begin{cases} h \notin C_v, \\ \forall j, (H_{v_j}(T_j) \cup H'_{v_j}(T_j)) \setminus [(H_{v_j}(T_j) \cup H'_{v_j}(T_j)) \cap \{h\}] \neq \emptyset \end{cases}$$

$$h \in H'_v(T) \Leftrightarrow \begin{cases} h \notin C_v, \\ \exists j \in \{1, \dots, d\}, h \in H_{v_j}(T_j) \text{ and } h \notin C_{[v, v_j]}, \\ \forall j' \neq j, (H_{v_{j'}}(T_{j'}) \cup H'_{v_{j'}}(T_{j'})) \setminus [(H_{v_{j'}}(T_{j'}) \cup H'_{v_{j'}}(T_{j'})) \cap \{h\}] \neq \emptyset \end{cases}$$

Proposition 7.8 For any $t \geq 2$, List-hypocoloring $_t$ in trees is polynomial.

Proof: Let us consider the following polynomial-time algorithm:

1. Choose a root $r \in V$ and orient the tree from r to leaves (T_v denotes the subtree induced by v and its descendants ;
2. Compute, for every node v and from leaves to the root, sets $H_v(T_v)$ and $H'_v(T_v)$ (by using lemma 7.7) ;
3. For every color in $H_r(T) \cup H'_r(T)$ compute a feasible hypocoloring by using lemma 7.7 (from the root to leaves) ;

The related complexity is $O(n\Delta^2)$. □

Corollary 7.9 *The hypocoloring problem is polynomial in trees with bounded degree. The related complexity is $O(\Delta^2 n^{\Delta+1})$.*

Remark 7.10 *It is easy to remark that we can polynomially transform a forest (T_1, \dots, T_p) with maximum degree Δ into a tree T with maximum degree Δ such that an optimal hypocoloring of the tree is an optimal hypocoloring of the forest. In order to do that, we iteratively take two subtrees of the forest that we link by the leaves with an additional node with cost 0.*

When the number of different weights of w is constant, we are able to give a polynomial algorithm on the tree. Indeed, by proposition 4.5, we know that the size of any optimal hypocoloring is bounded by $|w| + 1$, and then, the previous algorithm also works in polynomial-time:

Corollary 7.11 *The hypocoloring problem is polynomial in trees when the number $|w|$ of different weights is bounded. The related complexity is $O(n^{|w|+2})$.*

7.2 Graphs with maximum degree two

We shall examine here the special situation where the graph G has maximum degree $\Delta = 2$ (the case $\Delta = 1$ is trivial: G consists of isolated edges and nodes, so $\chi_h(G) = 1$). We prove by a similar technique of previously that the case of maximum degree two is also polynomial. However, the method presented here is slightly more involved than the previous one.

In our situation, the connected components of G are chains and cycles and all hypostable sets will consist of nodes and of edges (cliques of size 2). From proposition (4.2), there exists an optimal hypocoloring $\mathcal{S} = (S_1, S_2)$ of G with $w(S_1) \geq w(S_2)$ since $\Delta(G) = 2$. The case $S_2 = \emptyset$ is trivial and can be solved in linear-time. Thus, we will suppose $S_i \neq \emptyset$ for $i = 1, 2$ and more generally that $\chi_h(G) \geq 2$.

Lemma 7.12 *Let G consist of a collection of node disjoint chains C_1, \dots, C_p where each node v has weight $w(v) \geq 0$ and $\chi_h(G) \geq 2$; there exists a graph G' consisting of a single cycle C such that for any non negative integer r , G' has a 2-hypocoloring \mathcal{S}' with $\widehat{K}(\mathcal{S}') \leq r$ if and only if G has a 2-hypocoloring \mathcal{S} with $\widehat{K}(\mathcal{S}) \leq r$*

Proof: Let a_i, b_i be the end nodes of chain C_i in G for $i = 1, \dots, p$. We introduce into G new nodes c_i, d_i with weight $w(c_i) = w(d_i) = 0$ and new edges $[c_i, d_i], [d_i, a_i], [b_i, c_{i+1}]$ for $i = 1, \dots, p$ (the indices are taken modulo p , which implies that $[b_p, c_{p+1}]$ is $[b_p, c_1]$). Let G' be the graph obtained in this way. Clearly any k -hypocoloring ($k \geq 2$ since $\chi_h(G) \geq 2$ if G' is not a triangle) \mathcal{S} of G can be extended to a k -hypocoloring \mathcal{S}' of G' with $\widehat{K}(\mathcal{S}) = \widehat{K}(\mathcal{S}')$: consider w.l.o.g. nodes c_i, d_i ; if $b_{i-1} \in S_c$ and $a_i \in S_d$ ($c \neq d$) then introduce c_i into S_d and d_i into S_c . If $\{b_{i-1}, a_i\} \subseteq S_c$ then introduce $[c_i, d_i]$ into S_d . Conversely, the restriction of a 2-hypocoloring \mathcal{S}' of G' to the nodes of G gives a 2-hypocoloring \mathcal{S} of G with $\widehat{K}(\mathcal{S}) = \widehat{K}(\mathcal{S}')$. \square

As a consequence, we may restrict our attention to graphs $G = (V, E)$ whose connected components are cycles and let $n = |V| = |E|$. We will define the weight $w(e)$ of an edge $e = [x, y]$ as the sum $w(x) + w(y)$. Then, we notice that there are at most $n + t + 1$ possible values for $w(S_1)$

where t is the number of triangles of G and $2n$ possible values for $w(S_2)$. It is important to notice that we cannot solve separately the problem in each connected component as we can done in the unweighted version: an optimum hypocoloring is not necessarily formed by optimum hypocoloring on each connected components (see in particular the instance given by two chains of length two (x_1, x_2, x_3) and (y_1, y_2, y_3) with $w(x_1) = 8$, $w(y_1) = w(y_2) = 5$, $w(x_2) = 3$, $w(x_3) = w(y_3) = 1$). From (iii) of proposition (4.2), we know that S_2 does not contain any K_3 . Thus, if there is a triangle in a hypostable set, it must be in S_1 .

Property 7.13 $\text{Max}_{v \in V} w(v) \leq w(S_1) \leq \max\{\text{Max}_{e \in E} w(e); \max_{K_3} w(K_3)\}$

For given values p, q ($p \geq q$) we shall determine using the procedure $A(p, q)$ whether a 2-hypocoloring $\mathcal{S} = (S_1, S_2)$ of G exists such that $w(S_1) = p$ and $w(S_2) = q$. Formally, the algorithm $A(p, q)$ is the following:

starting with the smallest possible value of p and the smallest possible value of $q \leq p$, we apply properties 7.14 to 7.17 (given below) to get the smallest q for which a solution (S_1, S_2) exists such that $w(S_1) = p$ and $w(S_2) = q$. If such a hypocoloring can be found, we store the current solution $\mathcal{S} = (S_1, S_2)$ with $\text{val}(\mathcal{S}) = p + q$ if it is better than the best solution found so far. Whenever such a solution has been found, we increase p to the next possible value and we start again with the minimum q . An optimal hypocoloring (S_1, S_2) will be given by the solution stored.

We shall use in $A(p, q)$ the following properties:

Property 7.14 *If $w(v) > q$, then $v \in S_1$; if x, y, z are three consecutive nodes on an induced P_3 with $x, y \in S_i$ then $z \in S_{3-i}$ for $i = 1, 2$.*

Property 7.15 *If for some edge $e = [x, y]$, we have $w(e) > p$, then x, y are neither both in S_1 nor both in S_2 ; if $w(e) > q$, then x, y are nor both in S_2 . In such situations, we shall simply say that the color i is not feasible for edge $e = [x, y]$.*

Starting from G with given values p, q we will apply the above properties as long as possible to derive consequences on the colors to be assigned to the nodes and to the edges of G . For instance, if $e = [x, y]$ verifies $w(x) > q$ and $w(y) > p - q$, then $x \in S_1$ and $y \in S_2$.

We will then arrive to a situation where no solution exists (this may occur for instance if 3 consecutive nodes must get the same color or if there exists an odd cycle where color 1 is forbidden for all edges) or where some nodes have obtained some fixed color and we are left with a collection of chains whose end nodes have some fixed color (but no intermediate node is colored) and with some cycles which have no fixed color; in addition some edges may have forbidden colors. Observe in particular that a 2-hypocoloring may exist even if colors 1 and 2 are forbidden for some edge $e = [x, y]$; this simply means that x and y must have different colors.

In the remaining cycles without fixed colors, we have two possible situations: if C_i has even length, then we alternate colors 1 and 2 (in other words, we produce a coloring). If C_i has odd length, then by the previous remark, we know that there exists an edge e for which color 1 is feasible. So, we introduce this edge into S_1 and we alternate colors 1 and 2 for the remaining nodes.

Now, each remaining cycle C_i has at least one node with a fixed color. We can describe C_i by the sequence $(F_1, D_1, F_2, \dots, F_k, D_k)$ where F_i and D_i are chains. Moreover for any i , all nodes of F_i have a fixed color and each D_i has two endpoints with a fixed color and all intermediate nodes are uncolored. Note that some F_i may be empty (in this case, i.e., $F_i = \emptyset$, we identify the terminal endpoint of D_{i-1} with the initial endpoint of D_i) and each D_i has at least 3 nodes. Thus for instance, if in a cycle C , property (7.14) determines the color of exactly one node, say a , then the sequence consists of chain D_1 and its two endpoints are the same node a .

Let a_1, \dots, a_s be the nodes of the chain D_i where a_1 and a_s have fixed colors. If $a_1 \in S_1$, then for $e = [a_1, a_2]$ color 1 cannot be forbidden because this would force $a_2 \in S_2$. If $a_1 \in S_2$, then similarly for $e = [a_1, a_2]$ color 1 cannot be forbidden. So, we have $w(a_1) + w(a_2) \leq p$ for $a_1 \in S_1$ or $w(a_1) + w(a_2) \leq q$ for $a_1 \in S_2$; in addition for each intermediate node a_i , we have $w(a_i) \leq q$. For a_s we have the same relations as for a_1 .

Property 7.16 *Let D_i with nodes a_1, \dots, a_s be a chain such that $a_1, a_s \in S_j$ with s odd or such that $a_1 \in S_j, a_s \in S_{3-j}$ with s even for some $j = 1, 2$.*

Then there exists a 2-hypocoloring $\mathcal{S} = (S_1, S_2)$ where the colors 1 and 2 alternate in D_i .

Proof: This follows immediately from the observation that for all intermediate nodes a_i , we have $w(a_i) \leq q$. \square

Property 7.17 *Let D_i with nodes a_1, \dots, a_s be a chain such that $a_1, a_s \in S_j$ with s even or such that $a_1 \in S_i, a_s \in S_{3-j}$ with s odd for some $j = 1, 2$.*

Then there exists a 2-hypocoloring $\mathcal{S} = (S_1, S_2)$ such that $[a_1, a_2]$ gets one of its feasible colors.

Proof: Assume $a_1 \in S_1$; we have observed that we have in this case $w(a_1) + w(a_2) \leq p$, so we can introduce a_2 into S_1 and we are back to the case of property (7.16).

Similarly if $a_1 \in S_2$, we have $w(a_1) + w(a_2) \leq q$, so we introduce a_2 into S_2 and we are in a similar situation. The result follows from property (7.16). \square

Finally, for each chain D_i , we apply properties (7.16) and (7.17) and we color properly the remaining cycles. Now, when a value of p is fixed, we observe that the consequence of properties (7.14) and (7.15) can be obtained in $O(n^2)$ steps and gives a feasible value of q (if there exists). Then again in $O(n)$ steps, we can apply properties (7.16) and (7.17) to determine a 2-hypocoloring. It should be observed that cases where no solution can be found occur only when consequence of properties (7.14) and (7.15) are drawn.

Proposition 7.18 *There exists a polynomial time algorithm of complexity $O(n^3)$ to determine an optimum hypocoloring in a graph G with $\Delta(G) \leq 2$.*

Proof: Let $\mathcal{S}^* = (S_1^*, S_2^*)$ be an optimal hypocoloring of G with $w(S_1^*) \geq w(S_2^*)$. Let study the situation where p is equals to $w(S_1^*)$: by construction, the consequence of properties (7.14) and (7.15) give a partial feasible solution. Then, the procedure $A(p, q)$ finds a value q such that the consequences of properties (7.16) and (7.17) also yield a complete feasible solution $\mathcal{S} = (S_1, S_2)$ of G

with $p = w(S_1) > q \geq w(S_2)$. We necessarily have $w(S_2^*) \geq q$ since q is a minimum value such that the partial solution exists; if $w(S_2^*) \neq q$, then we obtain a contradiction since $\widehat{K}(\mathcal{S}^*) > p + q \geq \widehat{K}(\mathcal{S})$; thus, we have $w(S_2^*) = q$ and the proposition follows. \square

8 An (exponential) algorithm for triangle-free graphs

We shall now consider graphs containing no induced triangles; these are precisely the graphs G for which the largest size $\omega(G)$ of a clique is two. In such graphs, hypostable sets consist of nodes and of edges (cliques of size 2). Such graphs can have arbitrarily large chromatic numbers; it follows that they can also have arbitrarily large hypochromatic number: indeed a triangle-free graph G with $\chi(G) \geq 2k$ has $\chi_h(G) \geq k$. If we had $\chi_h(G) < k$, then we could take a minimum hypocoloring $\mathcal{S} = (S_1, \dots, S_r)$ of G with $r < k$. Each S_i could be decomposed into two stable sets S'_i, S''_i (since it consists of nodes and of edges) and we would get a $2r$ -coloring ($\mathcal{S}' = (S'_1, \dots, S'_r, S''_1, \dots, S''_r)$) of G with $2r < 2k$, which is a contradiction. So, triangle-free graphs are far from being trivial with respect to "hypochromaticity".

We shall now show that, based on the separation principle (link two nodes or merge them) described for instance in Berge, chap. 15 [3] for usual colorings of graphs, we can develop a "light version" procedure for determining a hypocoloring \mathcal{S} with minimum cost $\widehat{K}(\mathcal{S})$ in a weighted triangle-free graph. This procedure will in addition exhibit in a striking way the symmetry between usual colorings and hypocolorings.

For usual colorings, one separates the possible colorings of a graph G into two classes by repeatedly choosing a pair of non adjacent nodes x, y . There is a one-to-one correspondence between the colorings of G where x and y have the same color and the colorings of the graph G_1 obtained from G by merging nodes x, y into a single node x' (linked to all neighbors of x and to all those of y in G).

In the same way there is a one-to-one correspondence between the colorings of G where x and y have different colors and the colorings of the graph G_2 obtained from G by introducing an edge $[x, y]$.

So, G can be replaced by G_1 and G_2 . We repeat this operation for each one of G_1 and G_2 as long as possible, i.e., until we obtain graphs containing no more pair of non adjacent nodes, i.e., graphs which are cliques. The size of the smallest clique obtained in this way is the chromatic number of G . This idea can be extended to weighted colorings of G : whenever we merge nodes x, y into xy , we set $w(xy) = \max\{w(x), w(y)\}$. The above algorithm can be applied as before. The clique with minimum weight will give the optimal cost of a weighted coloring.

Our purpose is to give an (exponential) algorithm for finding a hypocoloring \mathcal{S} with minimum cost $\widehat{K}(\mathcal{S})$ in a weighted triangle-free graphs by using an additional separation principle. Since, we are handling hypostable sets (i.e., sets of nodes and edges), we will have to introduce some blocking mechanism which will prevent us from introducing some edges into hypostable sets: if e is in some S_i , then no adjacent edge can be introduced into the same hypostable set S_i . The algorithm will be based on a "Contract or Connect" principle; we will call it the *COContract or Connect Algorithm* or shortly COCA. It is described in table 8.

Clearly such a procedure may be exponential. It enumerates in an implicit way all hypcolorings of G and finds the minimum value of the cost $\widehat{K}(\mathcal{S})$ of such hypcolorings \mathcal{S} .

Edges which are no longer allowed to be introduced into a hypostable set are *blocked*. While $II(H)$ separates the usual colorings of H as described above, procedure $II(H)$ separates the hypcolorings into two classes: the hypcolorings where x and y (linked) are in the same hypostable set and the hypcolorings where x and y are in different sets.

At the final stage, a graph H will be a clique with all edges blocked; the corresponding colorings can be reconstructed by looking at the name of each node which is obtained by concatenation of the names of the nodes which have been sequentially merged. The "light" version of the COCA algorithm is just the enumeration algorithm for usual (unweighted) colorings. Notice that even if G contains no triangles by assumption, the auxiliary graphs constructed by the separation procedure I and II may contain triangles.

Data: Weighted triangle free graph G

Output: A hypcoloring \mathcal{S} with minimum cost $\widehat{K}(\mathcal{S})$

1. **Initialisation:** All edges are free; $L = \{G\}$;

$s(G)$ =best solution so far; $w^* = +\infty$

2. While $L \neq \emptyset$ do

(a) Choose a graph H in L ;

(b) If H has at least one free edge then apply procedure $I(H)$

else (all edges are blocked)

i. If H is not a clique then apply procedure $II(H)$

else (H is a clique with all edges blocked)

A. $w = \sum_{v \in V(H)} w(v)$;

B. If $w < w^*$ then $s(G) = H$ and $w^* = w$;

3. Remove H from L and introduce the graphs H_1, H_2 (produced by separation procedure) if they exist into L ;

Table 1. The COCA Algorithm

We now describe the two separation procedures:

separation procedure $I(H)$

1. Choose a free edge $[x, y]$ in H ;

2. Let H_1 be obtained from H by condensing $[x, y]$ into a node xy with $w(xy) = w(x) + w(y)$; all edges adjacent to xy are blocked;

3. Let H_2 be obtained from H by blocking $[x, y]$;

separation procedure $II(H)$

1. Choose two non adjacent nodes x, y in H ;

2. Let H_1 be obtained from H by condensing x, y into a node xy with $w(xy) = \max\{w(x); w(y)\}$; all edges adjacent to xy remain blocked;

3. Let H_2 be obtained from H by introducing the edge $[x, y]$; $[x, y]$ is blocked;

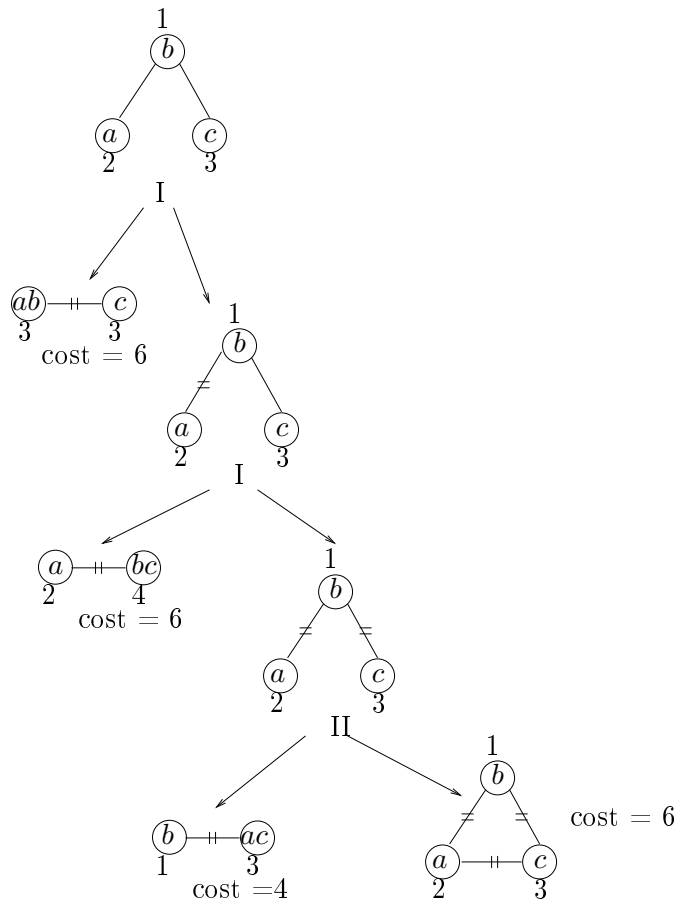

Figure 8: an illustration of the COCA algorithm

Remark 8.1 *In the case where the hypostable sets are redefined as disjoint sets of cliques of size at most two (i.e., non-adjacent nodes and edges) then the COCA algorithm can be used to find optimal "hypocolorings" in arbitrary graphs.*

An illustration of the COCA algorithm is given in Figure 8 for a small exemple.

Notice that the COCA algorithm could be extended to handle the case of hypostable sets containing no clique of size greater than a given r , but its formulation would not be as elegant as the above one.

9 Some extensions and variations

In the above batch scheduling model described in section 2, we have required that each connected component of the subgraph induced by a hypostable set S be a clique (of size one or more). This may be too strong. Each connected component of the subgraph induced by S is a collection of operations assigned to the same processor; they will hence be processed consecutively. But they need not be all pairwise incompatible. Such operations could simply be required to form a connected component of the subgraph induced by S or, in other contexts, a subgraph verifying a hereditary property P ; we will call such colorings *conditional subcolorings (or P -subcolorings)*. These notions are linked (in their unweighted versions) to the concept of *conditional colorings* of G with respect to a graph theoretical property P ; the conditional chromatic number $\chi(G, P)$ is the minimum integer k such that there is a partition of the nodes into k sets such that the subgraph induced by each set has the property P (see Albertson et al. [1], Dillon [10] or Harary [14]). An important application of conditional coloring is the circuit manufacturing problem and is defined by $P(V') = \text{true}$ iff the subgraph induced by V' is planar; the number $\chi(G, \text{Planar})$ is also known as the *node thickness* of a graph (see Beineke and White [2] and Mutzel et al. [16] for a survey).

So, we could consider more general hypostable sets and define their weights in an appropriate way. If for instance S is an arbitrary subset of nodes in a weighted graph G such that each connected component C of S verifies property P , let $\mathcal{C}(S)$ be the collection of connected components C in the subgraph induced by S . Let f be a function giving the cost of connected component C (f takes into account the cost of operations in C); so we can have $f(C) = \sum_{v \in V(C)} w(v)$ or $f(C) = \max_{v \in V(C)} w(v)$ for each connected component $C \in \mathcal{C}(S)$ where $V(C)$ is the node set of C . In any case, we suppose that the function f on $\mathcal{P}(V)$ verifies:

$$\forall v \in V, f(\{v\}) = w(v) \tag{9.1}$$

Then, as before, $w(S) = \max\{f(C) \mid C \in \mathcal{C}(S)\}$. Hence, a P -generalized hypocoloring of the weighted graph $G = (V, E)$ with respect to f will be a partition \mathcal{S} of the node set V into k (disjoint) such subsets S_1, \dots, S_k ; the cost $\widehat{K}(\mathcal{S})$ will be defined as:

$$\widehat{K}(\mathcal{S}) = \sum_{i=1}^k w(S_i)$$

where for each i , $w(S_i) = \max\{f(C) \mid C \in \mathcal{C}(S_i)\}$.

- In this paper, we mainly refer to the case $f(C) = \sum_{v \in V(C)} w(v)$ and P is the property to be a clique. As in the previous sections, an optimum value will be indifferently denoted by $\widehat{K}(\mathcal{S})$ or $\Pi(G, \text{Clique}, \text{sum})$.

- In the more general situation corresponding to the case without constraints, we have $f(C) = \sum_{v \in V(C)} w(v)$ and P is the trivial property (always equals to true). Note that if all weights are equal to one, then $w(C) = |V(C)|$ and $w(C)$ is the number of nodes in the largest connected component of the subgraph induced by S . If each C is constrained to be a single node, then we have the classical node k -coloring concept.
- When $f(C) = \max_{v \in V(C)} w(v)$ and P is the property to be a clique (i.e., we want study the quantity $\Pi(G, \text{Clique}, \max)$), we obtain another generalization of the coloring problem which has been studied under the name of *subcoloring* (see Brown and Corneil [8], Albertson et al. [1]). The *subchromatic number* of G is the smallest k for which there exists a partition of the node set into k hypostable sets (called substable sets). Basic complexity results related to subcolorings are given in Fiala et al. [11], namely proving that, if a graph G has subchromatic number equal to k , the associated problem is NP-complete in the graphs with maximum degree bounded above by k^2 for any $k \geq 2$.

Observe finally that P -generalized hypocolorings of a weighted graph G with respect to f exist for any hereditary property P . So the following quantity can be computed:

$$\Pi(G, P, f) = \min\{\widehat{K}(\mathcal{S}) \mid \mathcal{S} \text{ is a } P\text{-hypocoloring of } G \text{ with respect to } f\} \quad (9.2)$$

In this case, clearly we have $\Pi(G, P, f) \leq \Pi(G, \max)$ where in $\Pi(G, \max)$, the predicate is defined by: $\forall V' \subseteq V, P(V') = \text{true}$ iff $|V'| = 1$ (the quantity $\Pi(G, \max)$ has been studied in demange et al. [9]) since P is a hereditary property and f verifies property (9.1). We also derive an upper bound on these quantities:

Proposition 9.1 *Let $G = (V, E, w)$ be a weighted graph and $\mathcal{S} = (S_1, \dots, S_k)$ a partition of node set V of G . If $V(C)$ denotes the node set of a connected subgraph C in G and $w_{\max}(V') = \max_{v \in V'} w(v)$ for any $V' \subseteq V$, we have for any hereditary property P and function f verifying (9.1) :*

$$\Pi(G, P, f) \leq \sum_{i=1}^k w_{\max}(S_i) \max\{|V(C)| : C \in \mathcal{C}(S_i)\} \quad (9.3)$$

Proof: Assume there is a partition $\mathcal{S} = (S_1, \dots, S_k)$ of the node set of G and a hereditary property P and a function f verifying (9.1) such that: $\sum_{i=1}^k w_{\max}(S_i) \max\{|V(C)| : C \in \mathcal{C}(S_i)\} < \Pi(G, P, f) \leq \Pi(G, \max)$; then each S_i can be partitioned into at most $\max\{|V(C)| : C \in \mathcal{C}(S_i)\}$ stable sets; since the value of each such stable set in S_i is at most $w_{\max}(S_i)$, this would give a weighted coloring of G with a value strictly smaller than $\Pi(G, \max)$, which is impossible. \square

In fact, we could define the weighted chromatic number of a weighted graph G by:

$$\Pi(G, \max) = \min_{\mathcal{S}=(S_1, \dots, S_p) \text{ partition of } V} \sum_{i=1}^p w_{\max}(S_i) \max\{|V(C)| : C \in \mathcal{C}(S_i)\}$$

Indeed $\Pi(G, \max)$ never exceeds the right hand side. Consider an optimal weighted coloring $\mathcal{S}^* = (S_1^*, \dots, S_k^*)$ (i.e., with $\Pi(G, \max) = \sum_{i=1}^k w(S_i^*)$); for the corresponding partition we have

$|V(C)| = 1$ for every connected component of every S_i^* ; hence, we have equality for this specific partition. Thus, when all weights are one, we get an alternative definition of the chromatic number; if we are given an arbitrary partition of the node set, it may also provide an upper bound on $\chi(G)$.

On the other hand when we restrict to the graphs without $(k+1)$ -clique, we have for our problem the following inequality:

Lemma 9.2 *If G is $(k+1)$ -clique free then we have:*

$$\Pi(G, \text{clique}, \text{sum}) \leq \Pi(G, \text{max}) \leq H_k \Pi(G, \text{clique}, \text{sum}) \quad (9.4)$$

where H_k is the k -th harmonic number (i.e., $H_k = \sum_{i=1}^k 1/i$).

Proof: The first inequality has been proved. Let $\mathcal{S}^* = (S_1^*, \dots, S_r^*)$ be an optimum hypocoloring of G . We denote by C_i for $i = 1, \dots, r_1$ the connected components of S_1^* . We split the hypostable set S_1^* into stable sets $S_{1,1}^*, \dots, S_{1,k}^*$ by the following procedure: $v \in S_{1,1}^*$ if and only if there exist $j \leq r_1$ such that $v \in C_j$ and $w(v) = \max_{x \in C_j} w(x)$. In other words, $S_{1,1}^*$ consists of the set of elements of each connected component which have the largest weight. Then, we delete $S_{1,1}^*$ from S_1^* and we repeat the procedure until S_1^* is empty. Then, we repeat the procedure on S_2^* until we obtain a complete coloring. We know by construction that there exists at most k such stable sets from S_i^* since G is $(k+1)$ -clique free (we can also have $S_{i,k}^* = \emptyset$ for some $i \leq r$). We show that we have for $i = 1, \dots, r$ and for $j = 1, \dots, k$:

$$w(S_{i,j}^*) \leq \frac{w(S_i^*)}{j} \quad (9.5)$$

We only prove the result for $i = 1$ since it suffices to delete S_1^* from G to obtain the result for $i = 2$ and so on. If $j = 1$, the result is trivial. Let $j \leq k$ be an integer such that $w(S_{1,j}^*) \neq 0$ (otherwise, the result is again trivial); denote by v_j a node of $S_{1,j}^*$ verifying $w(v_j) = w(S_{1,j}^*)$. By construction in the hypostable set S_1^* , there exists a j -clique K_j such that $v_j \in K_j$ and for any other node v of K_j we have $w(v) \geq w(v_j)$. Thus, we obtain $j w(v_j) \leq \sum_{v \in K_j} w(v) \leq w(S_1^*)$.

Finally, we sum the inequality (9.5) over all i, j and we obtain the expected result. \square

Remark 9.3 *This bound is best possible. Consider $G = \cup_{i=1}^k K_i$ where K_i is a complete graph on i nodes and for any node v of K_i , we set $w(v) = k!/i$. Then $\Pi(G, \text{max}) = H_k \Pi(G, \text{clique}, \text{sum})$.*

We conclude this subsection with an inequality on the size of any optimal P -hypocoloring \mathcal{S}^* of G with respect to criterion max (i.e., $\widehat{K}(\mathcal{S}^*) = \Pi(G, P, \text{max})$); thus, in this case the cost of a P -hypostable set S is $w(S) = \max_{x \in S} w(x)$. We will need some additional notations: we denote by $q = \chi_P(G)$ the quantity $\Pi(G, P, \text{max})$ when all weights of G are equal to one. We also respectively denote by $|\mathcal{S}^*|$ and $|w|$ the size of the solution \mathcal{S}^* and the size of the weight function w (i.e., the number of different values taken by w). Then, we have:

Proposition 9.4 *Let $G = (V, E, w)$ be a weighted graph with $w(v) > 0$ for any node v ; every optimal P -hypocoloring $\mathcal{S}^* = (S_1, \dots, S_k)$ of G with respect to criterion max such that $w(S_1) \geq \dots \geq w(S_k)$ satisfies: $w(S_i) > w(S_{i+q-1})$, for any $i \leq k - q$. Thus, we have:*

$$|\mathcal{S}^*| \leq 1 + |w|(\chi_P(G) - 1) \quad (9.6)$$

Proof: Let $\mathcal{S}^* = (S_1, \dots, S_k)$ be an optimal P -hypocoloring of G with respect to criterion max . Assume now that $q = \chi_P(G) \geq 2$; choose the smallest i such that $w(S_i) = \dots = w(S_{i+q-1}) \geq w(S_k)$. We have $i \leq k - q$ by assumption. Now $S_i \cup S_{i+1} \cup \dots \cup S_k$ induces a subgraph G' of G ; we have therefore $\chi_P(G') \leq \chi_P(G) = q$ since the property is hereditary, so there exists a P -coloring $(S'_i, \dots, S'_{i+q-1})$ of G' (with $i + q - 1 < k$). Assuming $w(S'_i) \geq w(S'_{i+1}) \geq \dots \geq w(S'_{i+q-1})$ we have $w(S'_i) = w(S_i)$ and $w(S'_{i+s}) \leq w(S'_i) = w(S_{i+s})$ for $s = 1, \dots, q - 1$ since the criterion is max . Setting $S'_j = S_j$ for $j = 1, \dots, i - 1$ we get an $(i + q - 1)$ P -coloring $\mathcal{S}' = (S'_1, \dots, S'_{i+q-1})$ of G with $\widehat{K}(\mathcal{S}') < \Pi(G, P, max)$ which is a contradiction. \square

Most of the results established in previous sections can be transposed to $\Pi(G, P, sum)$ and sometimes to $\Pi(G, P, max)$. Namely the approximation results and the properties of the size (or the value) of optimal solutions.

10 Conclusion

Further research will be needed in several directions to explore the field of hypocolorings. Batch scheduling is a motivation for this purpose, there are also several theoretical aspects which are of interest. For instance, finding in a bipartite graph a 2-hypocoloring with minimum cost (among those which use at most two colors) is an open problem to our knowledge (an optimum hypocoloring in such a graph may have more than two colors) or establishing complexity results for trees without restriction on the maximum degree.

In addition, heuristics for general graphs should be designed and tested. We hope that the initial results derived in this paper will be a first step along this line of development.

Acknowledgments. This work was partially carried out during a visit of the first author to the LAMSADE at Université de Paris-Dauphine in June 2002; the support of this institution is gratefully acknowledged.

References

- [1] M. O. ALBERTSON, R. E. JAMISON, S. T. HEDETNIEMI, and S. C. LOCKE, *The subchromatic number of a graph*, Discrete Math. **74** (1989), 33–49.
- [2] L. W. BEINEKE and A. T. WHITE, *Selected topics in graph theory*, Academic press, London, 1978.
- [3] C. BERGE, *Graphs and Hypergraphs*, North Holland, Amsterdam, 1973.
- [4] H. L. BODLAENDER, K. JANSEN, and G. J. WOEGINGER, *Scheduling with incompatible jobs*, Discrete Appl. Math. **55** (1994), 219–232.

- [5] M. BOUDHAR and G. FINKE, *Scheduling on a batch machine with job compatibilities*, Special issue ORBEL-14: emerging challenges in operations research (Mons 2000) Belg. J. Oper. Res. Statist. Comput. Sci. **40** (2000), 69–80.
- [6] H. BROERSMA, F.V. FOMIN, J. NESETRIL, and G. J. WOEGINGER, *More about subcolorings*, Computing **69** (2002), 187–203.
- [7] R. L. BROOKS, *On colouring the nodes of a network*, Proc. Cambridge Phil. Soc. **37** (1941), 194–197.
- [8] J. L. BROWN and D. G. CORNEIL, *On generalized graph colorings*, J. Graph Theory **11** (1987), 87–99.
- [9] M. DEMANGE, D. DE WERRA, J. MONNOT, and V. Th. PASCHOS, *Weighted node coloring: when stable sets are expensive (extended abstract)*, Proc. WG 02, LNCS **2573** (2002), 114–125.
- [10] M. R. DILLON, *Conditionnal coloring*, Ph.D. thesis, University of Colorado at Denver, 1998.
- [11] J. FIALA, K. JANSEN, V. B. LE, and E. SEIDEL, *Graph subcolorings: Complexity and algorithms*, Proc. WG 01, LNCS **2204** (2001), 154–165.
- [12] M. R. GAREY and D. S. JOHNSON, *Computers and intractability. a guide to the theory of NP-completeness*, CA, Freeman, 1979.
- [13] H. GROTZSCH, *Ein dreifarbensatz für dreikreisfreie netze auf der kugel*, Wiss. Z. Martin Luther Univ. Halle-Wittenberg, Math. Naturwiss Reihe **8** (1959), 109–120.
- [14] F. HARARY, *Conditional colorability in graphs*, in Graphs and Applications, Proc. First Colo. Symp. graph theory (F. Harary and J. Maybee eds), Wiley intersci., Publ. N.Y., 1985.
- [15] L. LOVÁSZ, *On decomposition of graphs*, Stud. Sci. Math. Hung. **1** (1966), 237–238.
- [16] P. MUTZEL, T. ODENTHAL, and M. SCHARBRODT, *The thickness of graphs: A survey*, Graphs Combin. **14** (1998), 59–73.
- [17] F. RENDL, *On the complexity of decomposing matrices arising in satellite communication*, Operations Research Letters **4** (1985), 5–8.
- [18] T. J. SCHAEFER, *The complexity of satisfiability problems*, Proc. STOC (1978), 216–226.