

Gestion Dynamique des Services Techniques pour Modèle à Composants

Colombe Hérault, Sylvain Lecomte

LAMIH / ROI / SID

DECOR 29 octobre 2004



LAMIH / ROI / SID

Colombe.Herault@univ-valenciennes.fr

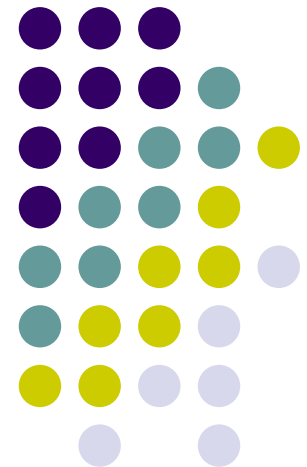

Plan



- Problématique
 - Services techniques dans les modèles à composants distribués techniques composants aptabilité l'annuaire respectives spectives

Application à base de composants et services techniques



conteneurs

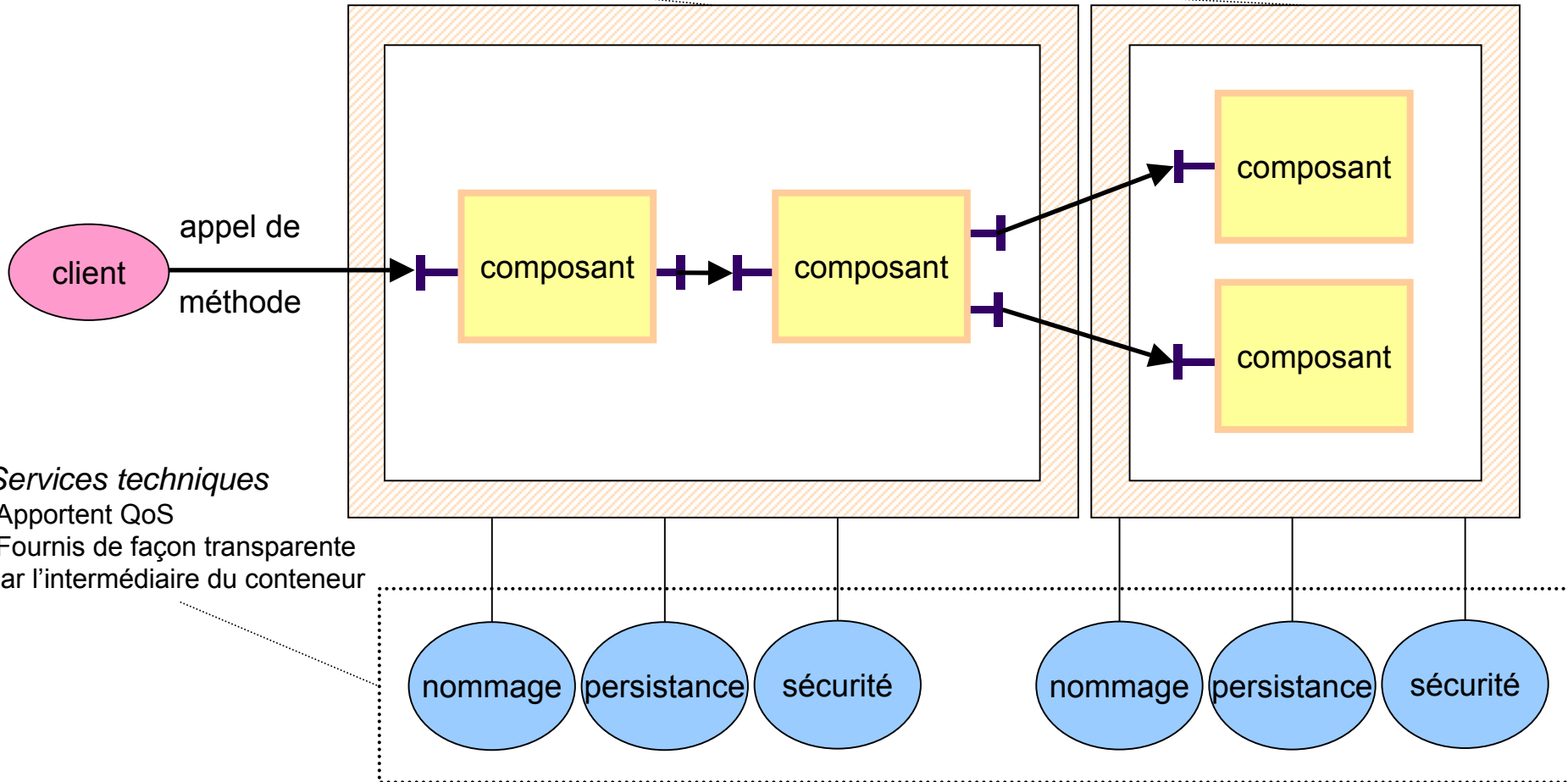

Nouvelles applications

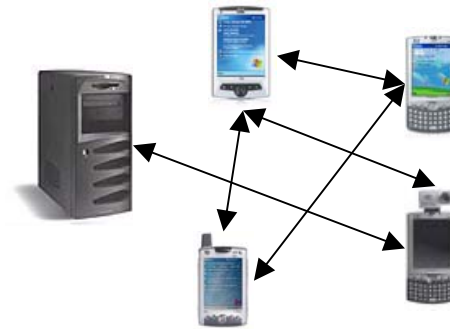
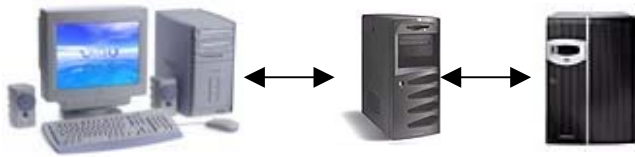

Application d'entreprise	Application de l'informatique ubiquitaire
Environnement fixe	Environnement hétérogène
3 tiers	p2p
Sûre, rapide, complexe, de taille importante, temps de dvpt long	Légère, svt déconnectée, Dynamiquement découverte temps de dvpt court
Développée grâce aux composants, bénéficie des services techniques	Solutions ad hoc

Motivations



conteneurs

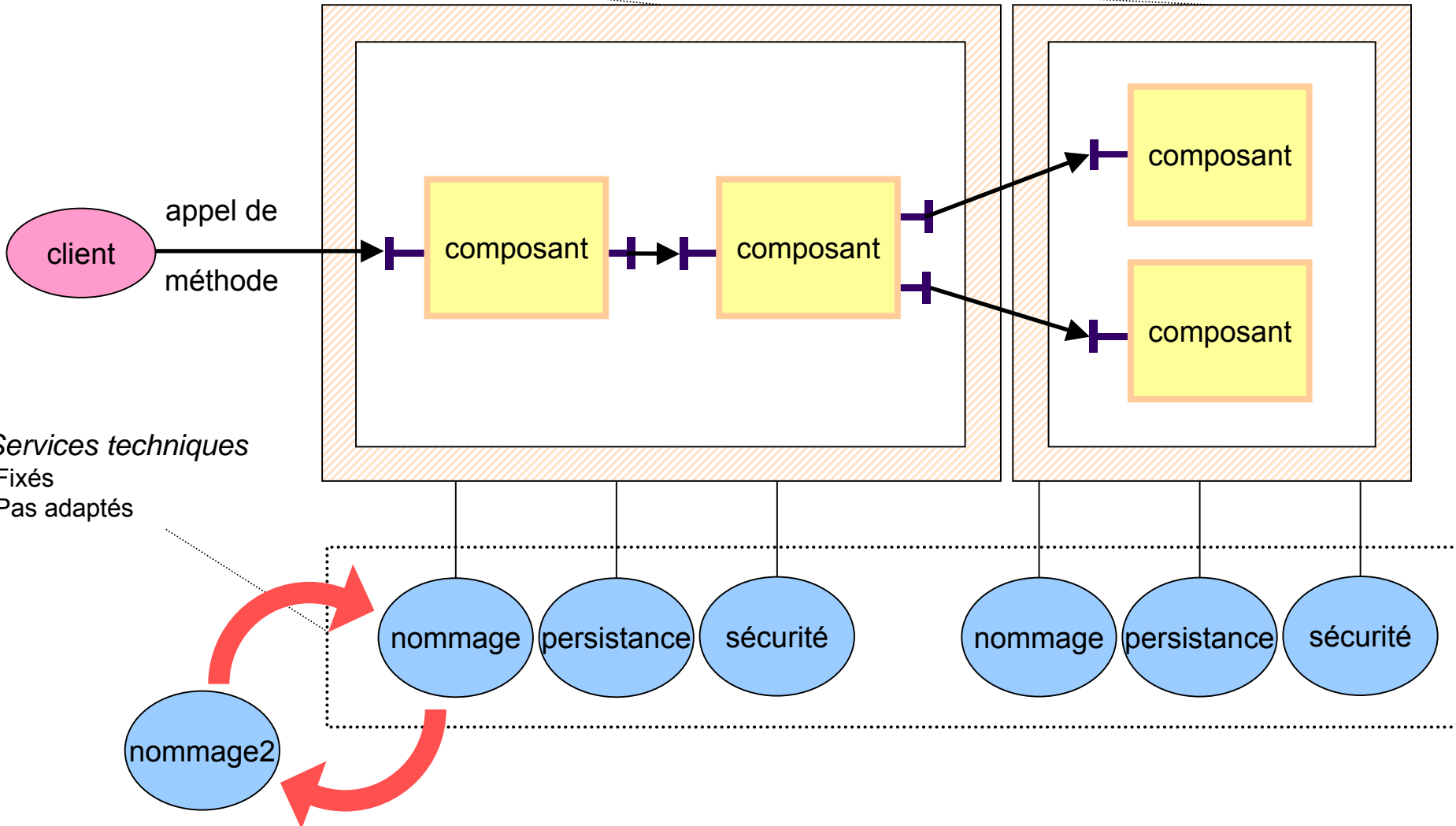

Services Techniques à base de composants



- Choix de Fractal
 - définition claire des concepts
 - Plusieurs niveaux
 - Composant/contrôleur/interface
 - composants composites et partagés
 - réflexivité
 - reconfiguration dynamique

Services Techniques à base de composants

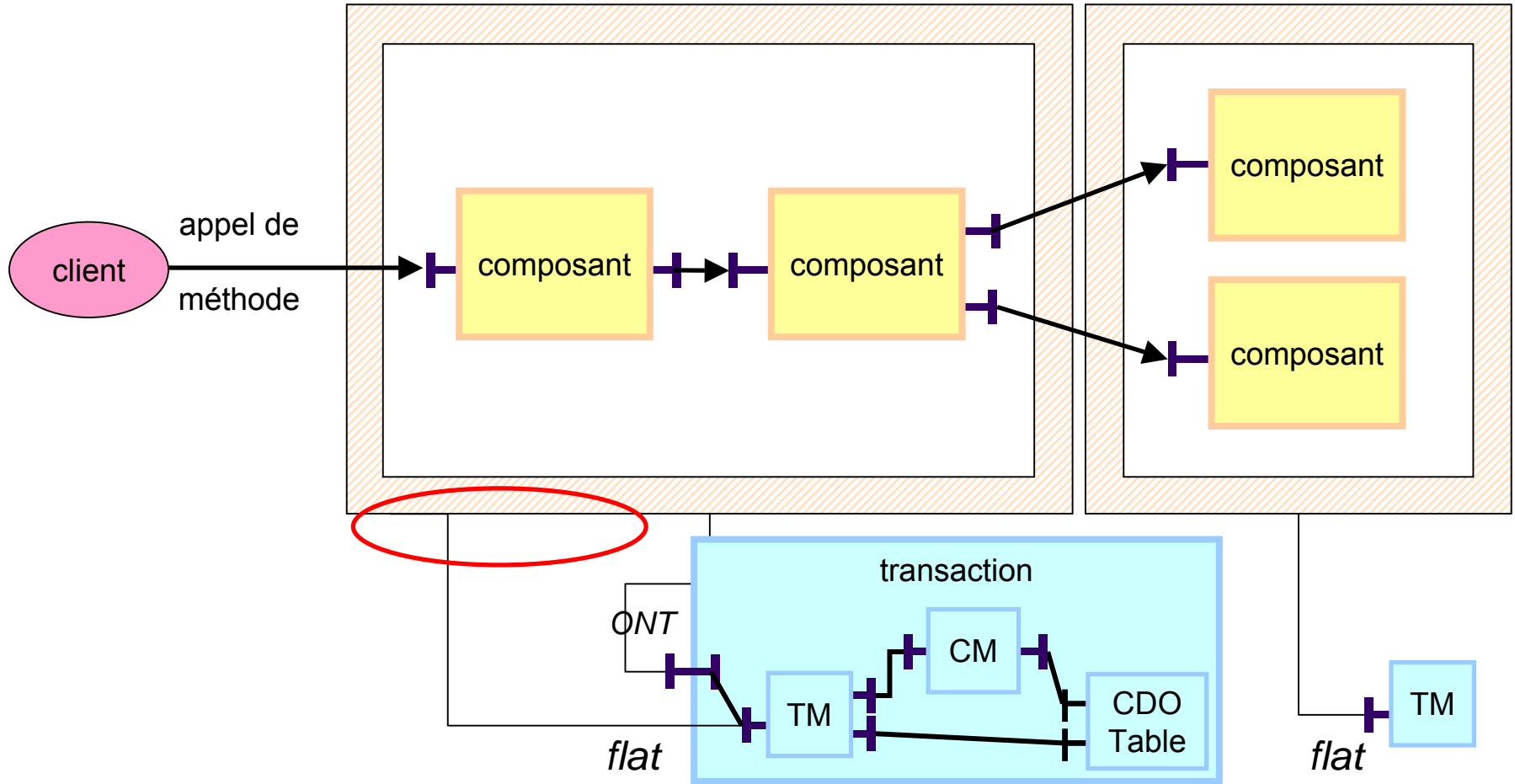

Composants de gestion

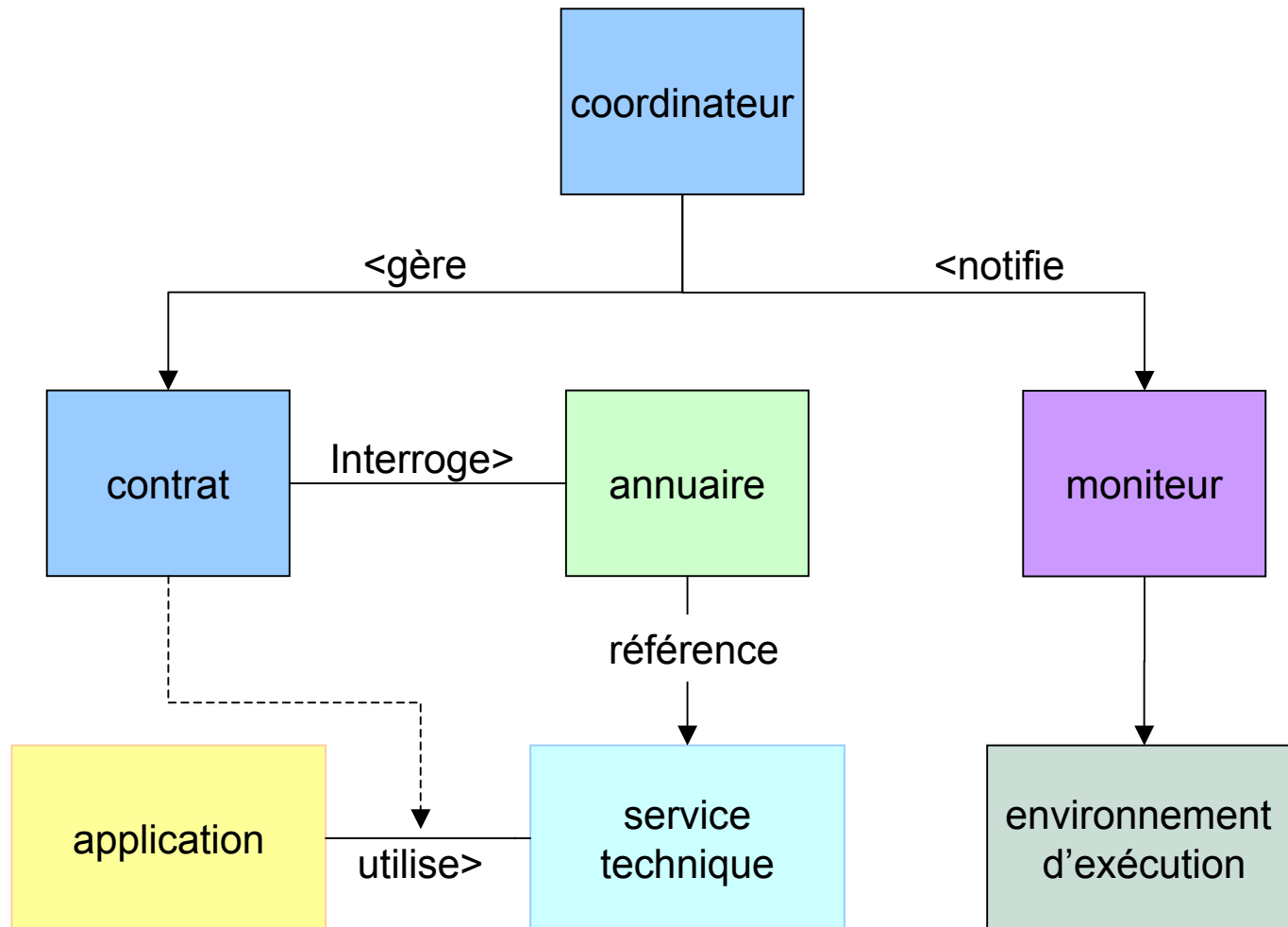

Prototype

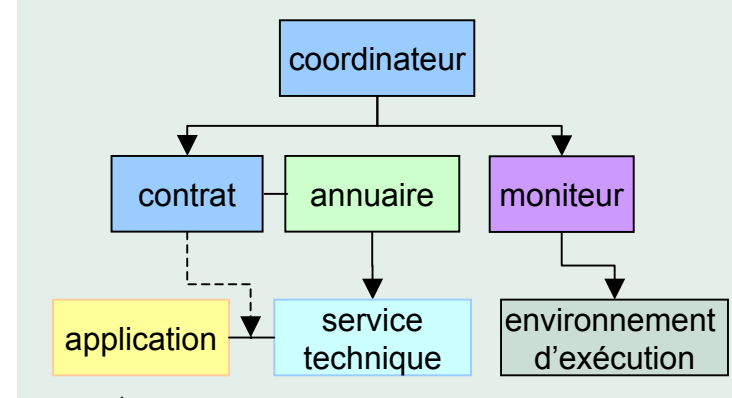
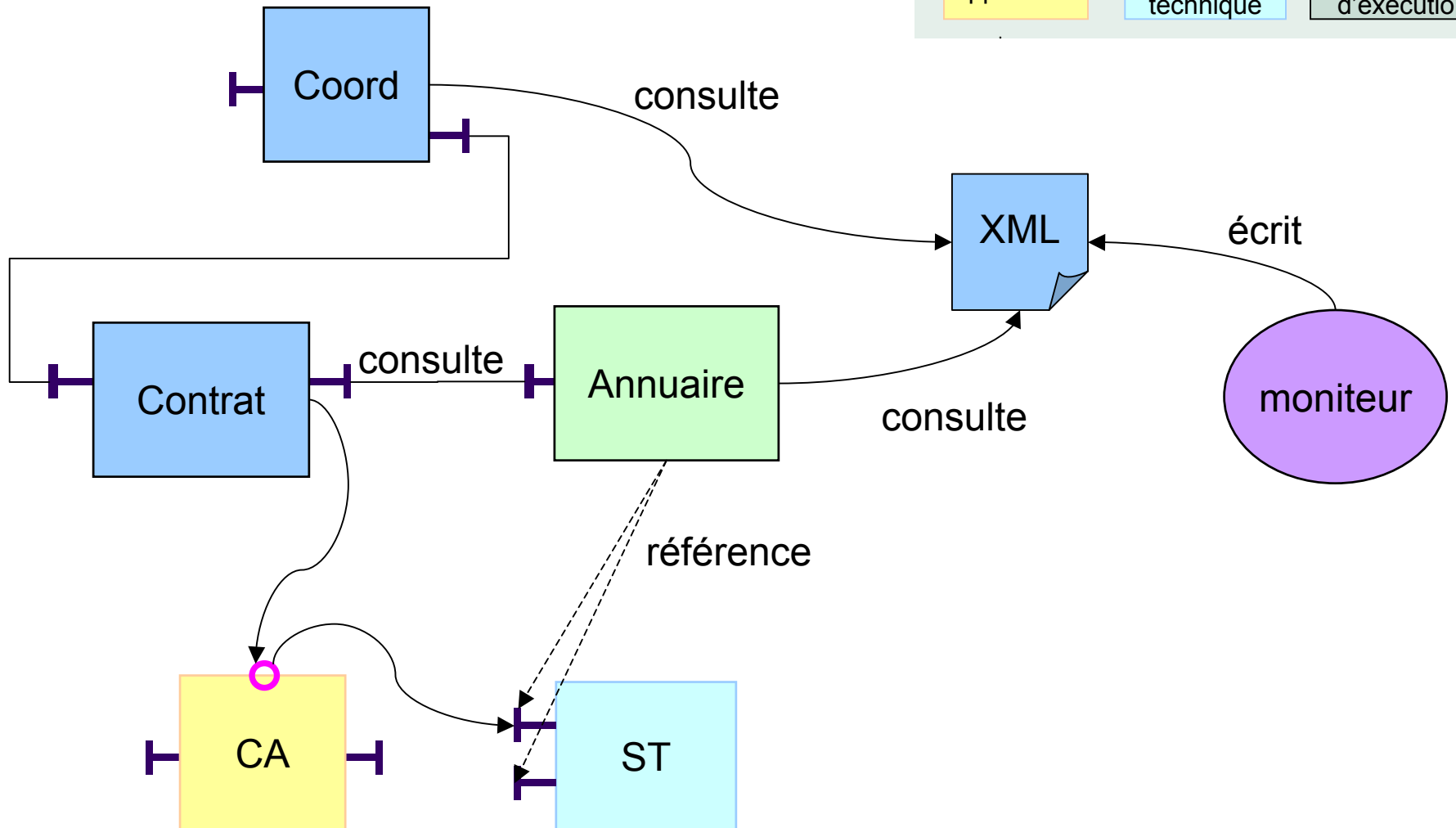

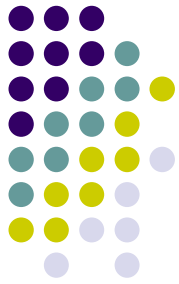

Annuaire

```
<Query xmlns:qs="http://objectweb.org/query">  
<Function>Transaction Service</qs:Function>  
<propertyMatching>  
  <queryInstance>  
    <queryTechnical>  
      <![CDATA [(version = FLAT)]]>  
    </queryTechnical>  
  </queryInstance>  
</propertyMatching>
```

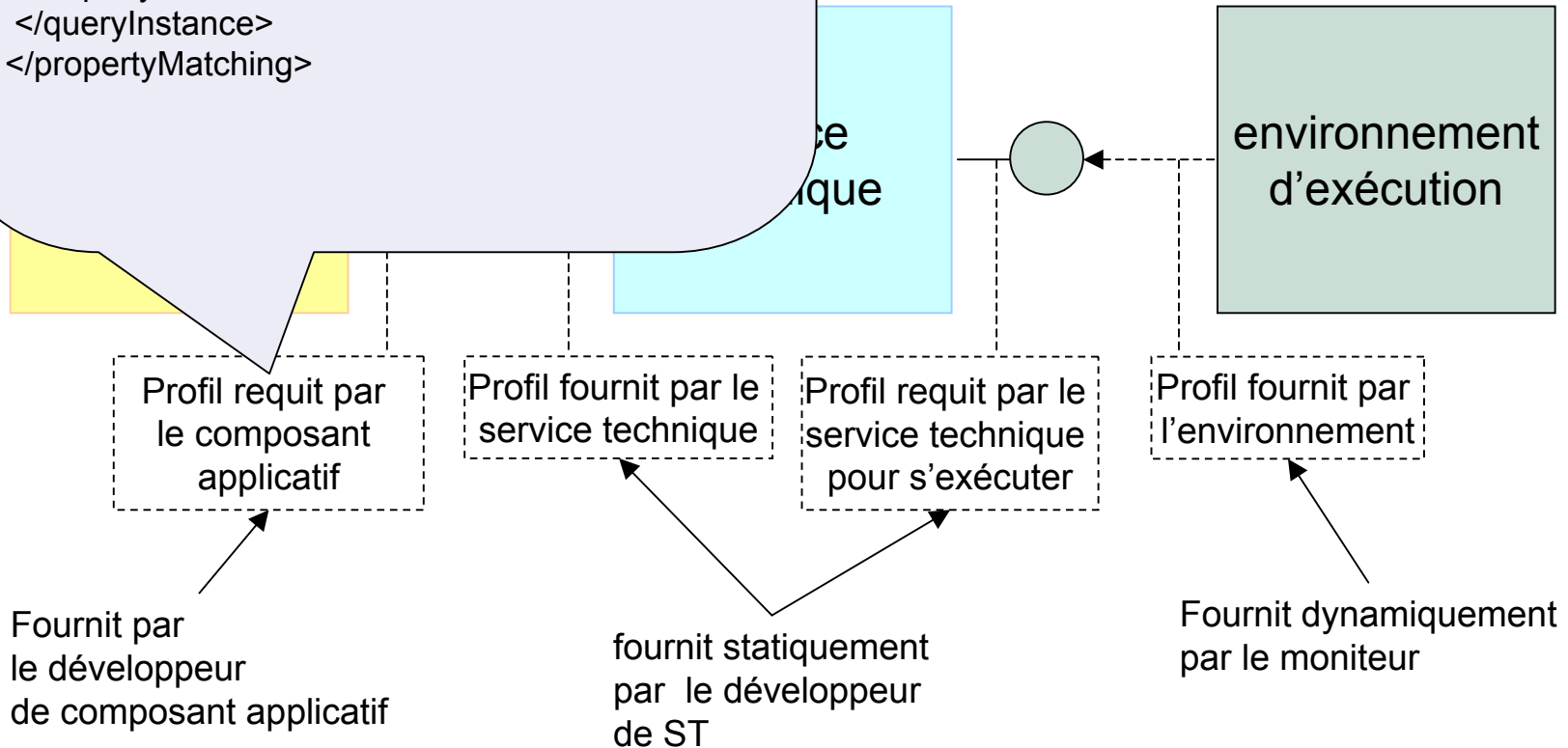

Requêtes de l'a

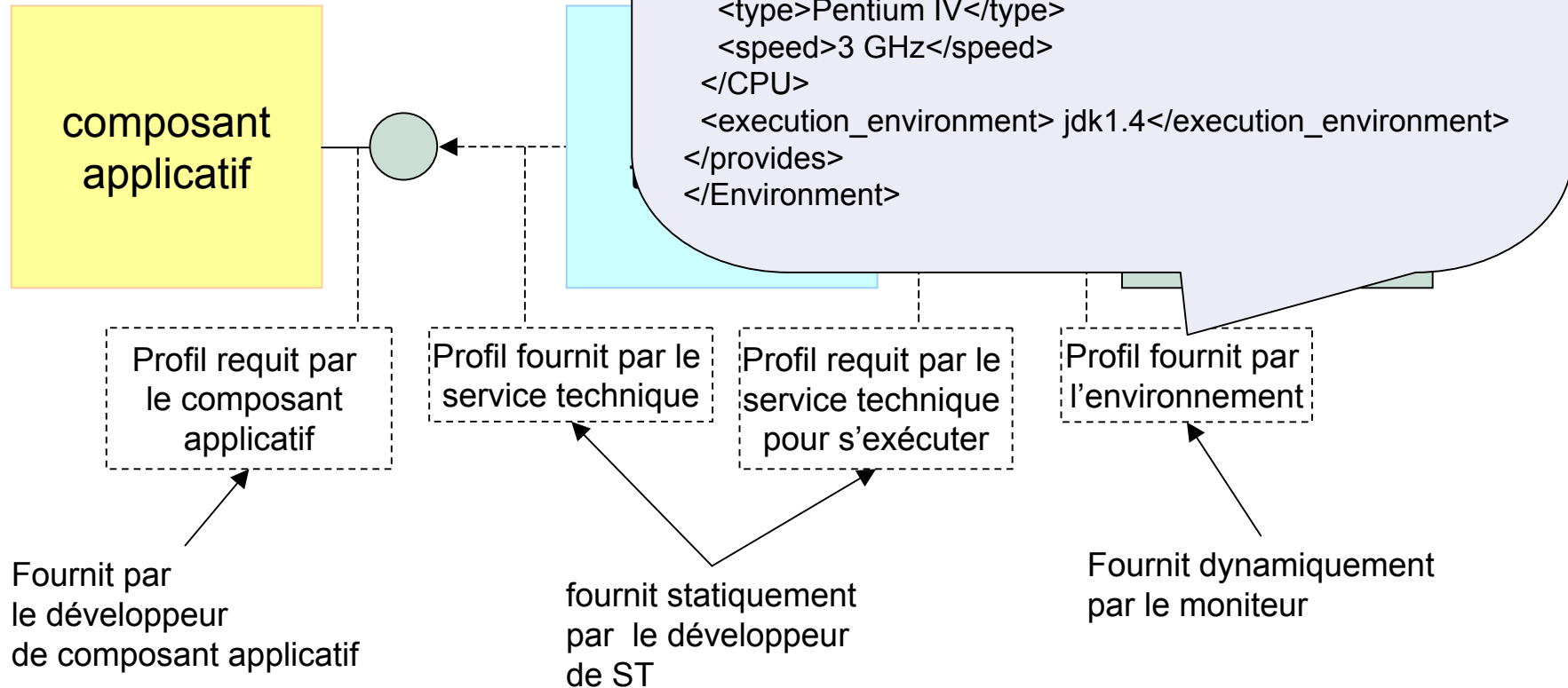

Requêtes de l'annuaire

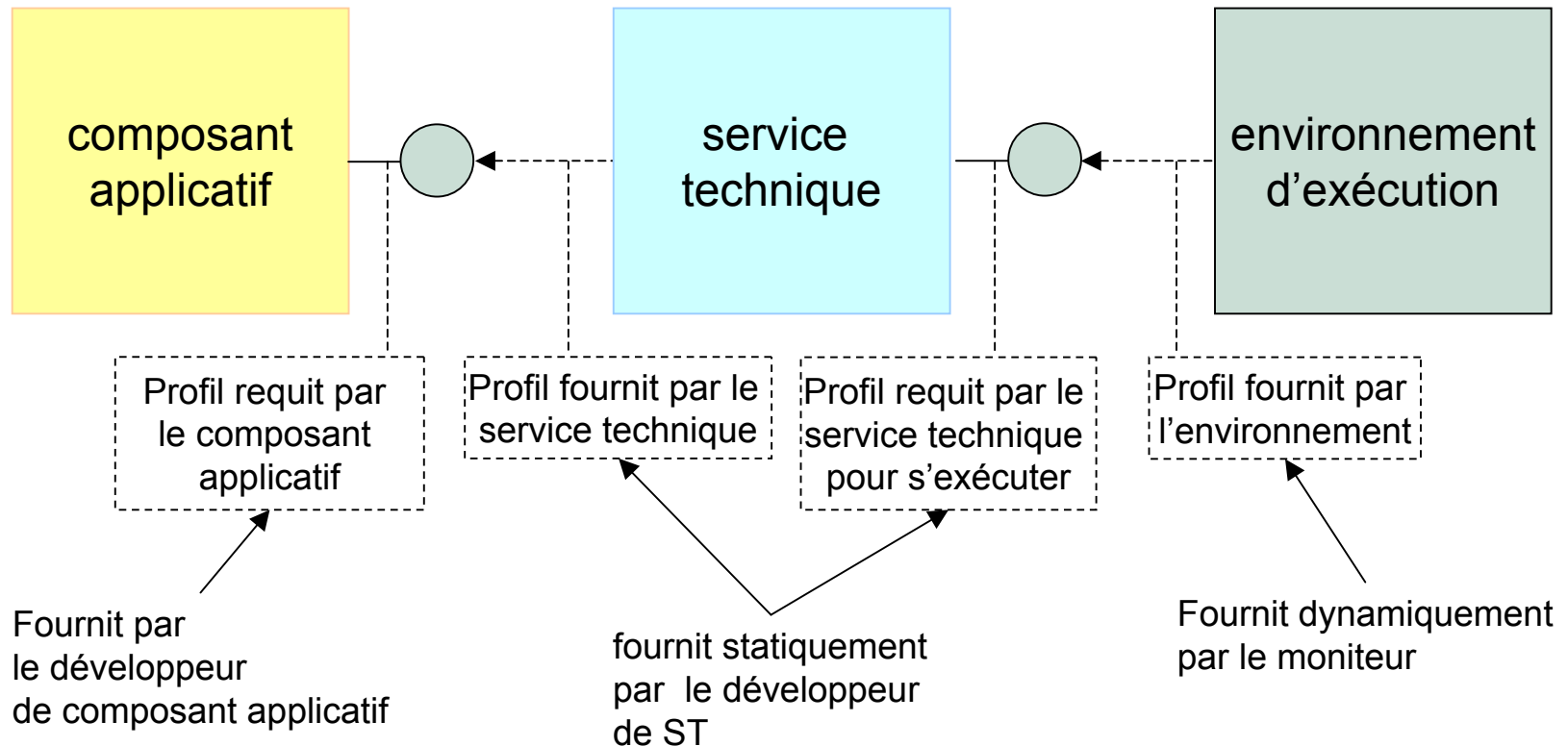

Focus sur l'annuaire

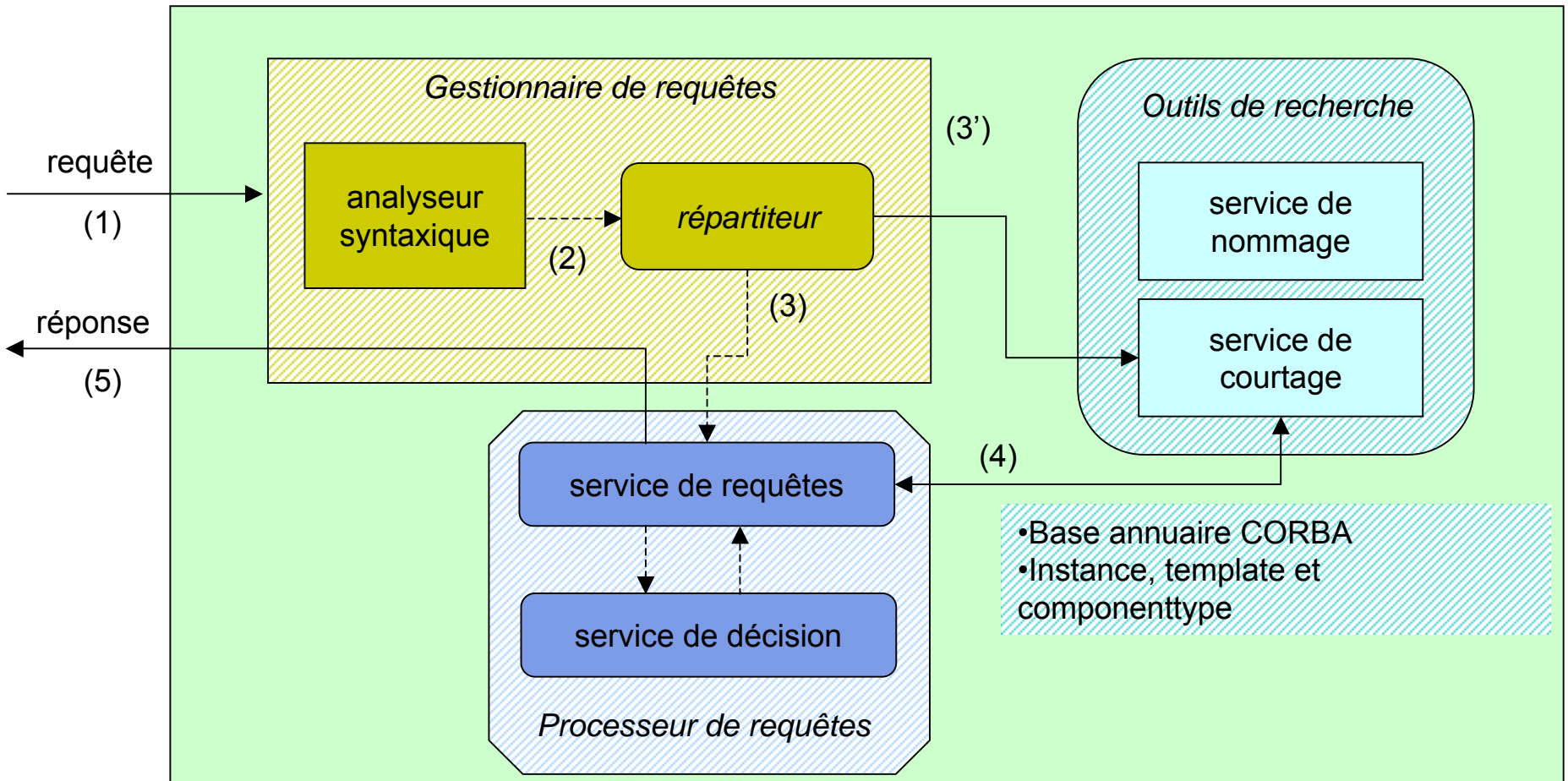

Prototype de l'annuaire

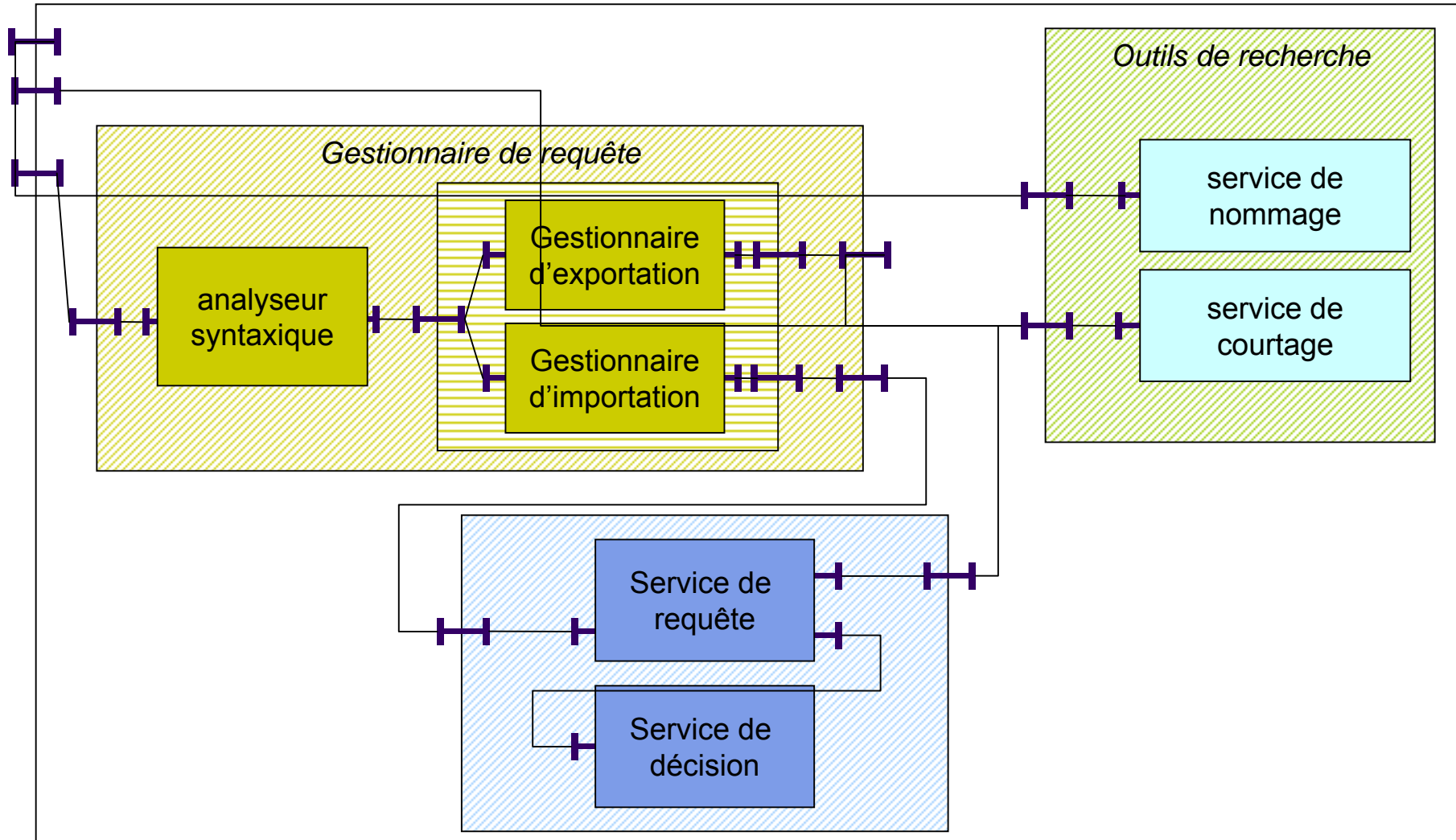

Conclusion et perspectives



- Services techniques adaptables à base de composants
 - Fractal
 - assemblage comp. appli / services techniques
- Composants de gestion
 - adaptabilité dynamique
 - prise en compte de l'environnement d'exécution
 - Contrat, annuaire, coordinateur, moniteur
 - Prototype fonctionnel

Conclusion et perspectives



- Prototype
 - Finesse des mises à jour
 - Annuaire
 - LDAP ou BD XML
 - Module de décision
- Acquisition et interprétation
 - Base de connaissances
 - Informations sur l'environnement d'exécution
- Sûreté de reconfiguration