



HAL
open science

**Influence of the structural modulations and the
Chain-ladder interaction in the
 $Sr_{14-x}Ca_xCu_{24}O_{41}$ compounds.**

Alain Gellé, Marie-Bernadette Lepetit

► **To cite this version:**

Alain Gellé, Marie-Bernadette Lepetit. Influence of the structural modulations and the Chain-ladder interaction in the $Sr_{14-x}Ca_xCu_{24}O_{41}$ compounds.. *Physical Review B: Condensed Matter and Materials Physics* (1998-2015), 2006, 74, pp.235115. hal-00003226v4

HAL Id: hal-00003226

<https://hal.science/hal-00003226v4>

Submitted on 30 Oct 2006

HAL is a multi-disciplinary open access archive for the deposit and dissemination of scientific research documents, whether they are published or not. The documents may come from teaching and research institutions in France or abroad, or from public or private research centers.

L'archive ouverte pluridisciplinaire **HAL**, est destinée au dépôt et à la diffusion de documents scientifiques de niveau recherche, publiés ou non, émanant des établissements d'enseignement et de recherche français ou étrangers, des laboratoires publics ou privés.

Influence of the structural modulations and the Chain-ladder interaction in the $Sr_{14-x}Ca_xCu_{24}O_{41}$ compounds.

Alain Gellé

*Laboratoire de Physique Quantique, IRSAMC - CNRS UMR 5626,
Université Paul Sabatier, 118 route de Narbonne, F-31062 Toulouse Cedex 4, FRANCE*

Marie-Bernadette Lepetit

*Laboratoire de Physique Quantique, IRSAMC - CNRS UMR 5626, Université Paul Sabatier,
118 route de Narbonne, F-31062 Toulouse Cedex 4, FRANCE and
Laboratoire CRISMAT, ENSICAEN - CNRS UMR 6508,
6 boulevard Maréchal Juin, F-14050 Caen Cedex, France*

(Dated: October 30, 2006)

We studied the effects of the incommensurate structural modulations on the ladder subsystem of the $Sr_{14-x}Ca_xCu_{24}O_{41}$ family of compounds using ab-initio explicitly-correlated calculations. From these calculations we derived $t - J$ model as a function of the fourth crystallographic coordinate τ describing the incommensurate modulations. It was found that in the highly calcium-doped system, the on-site orbital energies are strongly modulated along the ladder legs. On the contrary the two sites of the ladder rungs are iso-energetic and the holes are thus expected to be delocalized on the rungs. Chain-ladder interactions were also evaluated and found to be very negligible. The ladder superconductivity model for these systems is discussed in the light of the present results.

PACS numbers: 71.10.Fd, 71.27.+a, 71.23.Ft

I. INTRODUCTION

The $Sr_{14-x}Ca_xCu_{24}O_{41}$ family of compounds has attracted a lot of attention in the last years due to the discovery of a superconducting phase¹ in these quasi-unidimensional systems. The $Sr_{14-x}Ca_xCu_{24}O_{41}$ are layered materials with alternated planes of two-leg spin ladders and planes of spin chains². The superconducting phase, observed in the highly calcium-doped systems, at low temperature and under pressure, is believed to be the realization of the predicted superconductivity in two-leg ladders systems³. Indeed, it is currently assumed that the $Sr_{14-x}Ca_xCu_{24}O_{41}$ ladder subsystem can be represented by a two-leg ladder isotropic $t - J$ model with $J/t \sim 0.4$ and a hole doping ranging between 1⁴ and 2.8⁵ holes per formula unit (f.u.), that is between 0.07 and 0.2 hole per ladder site. Numerical as well as slave-bosons analytical calculations⁶, showed that in this parameter range, the superconducting pairing fluctuations are dominant. Hole-pairs are predicted to be bounded on the rungs and the superconductivity to be supported by pairs collective modes.

The $Sr_{14-x}Ca_xCu_{24}O_{41}$ compounds present structural incommensurate modulations of both the chains and ladder subsystems. It was shown⁷ using ab-initio calculations, that, unlike what was usually assumed, the chain subsystem cannot be considered as a quasi-homogeneous system for which the structural modulations induce only small perturbative effects. In fact, the modulations caused by the influence of the ladders on the chain subsystem are responsible for the low-energy physics of the latter, that is charge localization and spin arrangement. These ab-initio calculations showed that the parameters of the second neighbor $t - J + V$ model are strongly mod-

ulated. The major effects are (i) on the on-site magnetic orbital energies that fluctuate within a few electron-Volt range, (ii) on the first neighbor effective exchange integrals that range from ferromagnetic (as expected for such 90° oxygen-bridged copper sites) to antiferromagnetic (in the calcium highly-doped compounds). Moreover the calcium iso-electronic substitution, that acts as a chemical pressure, is responsible for large variations of the $t - J$ model parameters. It results a quite different chain ground-state for the undoped and highly-doped systems. The undoped compound exhibits the formation of second-neighbor dimers caused by the electron localization on sites with low orbital energy, while the large x compounds exhibit the formation of low spin clusters with antiferromagnetic local ordering.

One can thus wonder whether the structural modulations induce as important effects on the ladder electronic structure, as observed on the chain one. This point is of crucial importance since the existence of such an effect would strongly questioned the interpretation of the observed superconductivity. Another point, often addressed in the literature, is the importance of possible chain-ladder coupling. Indeed, in the highly calcium-doped compound, some of the chain oxygen atoms come close to the ladder coppers as apical atoms. The aim of the present work is to provide answers to these questions, by the means of ab-initio calculations. The method used is an embedded fragment spectroscopy method that explicitly computes both the correlation effects and the screening effects. A $t - J$ model, explicitly dependent on the structural modulations, is derived from the ab-initio results for the ladders. The calculations are done on both ladders and mixed, chain and ladder, fragments, in the low-temperature phases of both the undoped⁸ and

$x = 13.6$ calcium-doped⁹ compounds. It would have been of great interest to also run calculations in the superconducting phase, unfortunately structural data are not available under pressure. Nevertheless we will discuss possible extrapolation of the ambient pressure results.

The next section will be devoted to the computational details. Section 3 will discuss the $t - J$ model, section 4 will discuss the chain-ladder interactions and finally the last section will be devoted to discussions and conclusions.

II. METHOD AND COMPUTATIONAL AND DETAILS

It is well known that, in strongly correlated systems, few electrons (per unit cell) are responsible for their spectacular properties. These electrons are usually unpaired and localized both spatially and energetically near the Fermi level (from now on we will refer to them as magnetic electrons).

Consequently, the electronic wave function of these systems is essentially multi-configurational, i.e. it cannot be described, even in a qualitative way, by a single Slater determinant. The consequence is that single-reference based methods such as Hartree-Fock plus perturbation theory or even Density Functional Theory (DFT) fail to correctly treat some characteristics of the electronic structure of such systems¹⁰. While DFT methods yield reasonable Fermi surfaces such as in the doped superconductor copper oxides, the LDA method fails to predict the correct insulating versus metallic behavior in a lot of correlated systems or effective local interactions such as the magnetic exchange constant J . This is for instance the case for the same copper oxides for which the Fermi surfaces were correctly predicted. Indeed, the LDA estimate of the magnetic exchange in the La_2CuO_4 compound ranges for instance from 600 meV to 800 meV according to the functional used while the experimental measurements¹¹ yield 135 ± 6 meV and the embedded cluster method used in the present work 145 meV¹². LDA+U¹³ or constrained LDA¹⁴ (CLDA) methods that treat the correlation within the magnetic orbitals in a mean field scheme yield better results. For instance the LDA+U method yields between 129 and 165 meV for the J value of $Sr_2CuO_2Cl_2$ (exp. 125 meV) and the CLDA method yields 128 meV for the La_2CuO_4 compound. These methods however still present a lot of arbitrariness, for instance the uncertainty on the results for the CLDA are of 50% according to the authors of ref.¹⁴.

A few density functional calculations are present in the literature for the present system. Arai and coworkers¹⁵ performed a LDA calculation on the average structure (without the subsystem modulations) of the $Sr_{14}Cu_{24}O_{41}$ in quasi periodic approximation. Their results exhibit a metallic behavior for both the chains and ladders subsystems whereas they are experimentally found to be insulating. More recently, unpublished results from Schuster

and Schwingenschlgl¹⁶ found the same results when including the structural modulations. Let us point out that the LDA+U method should yield better results on such strongly correlated systems. Unfortunately calculations including the structural modulation necessitate a much too large quasi-periodic unit cell for the calculation to be tractable.

For such problems it is therefore necessary to rely on wave-function, multi-reference, ab-initio, spectroscopy methods such as the Difference Dedicated Configurations Interaction^{17,23} (DDCI) on embedded clusters. This method proved its ability to quantitatively reproduce the local interactions of a large family of magnetic systems such as high T_c copper oxides¹², vanadium oxides¹⁸, nickel and cuprate fluorides¹⁹, etc. Such multi-reference wave function methods are very powerful to treat strong correlation problems, however they necessitate a formally finite system. The use of such methods for the treatment of strongly correlated materials is possible since the interactions between the magnetic electrons are essentially local. In fact it was proved, both by quasi-degenerate perturbation analysis²⁴ and numerically by increase of the cluster size^{20,21,22,25} that only the bridging ligands and the first coordination shell of the magnetic centers are of importance for the magnetic, transfer or coulomb interactions.

The DDCI method is a variational method specifically designed for the calculation of excited states involving open shells. It is based on the exact diagonalization of a selected configuration space built as follow. First a partition of the cluster orbitals in occupied, active and virtual is defined. The active set of orbitals is defined to be the magnetic orbitals supporting the low energy physics as defined above. In the present work this set of orbitals is formed by the open $3d$ orbitals of the copper atoms, that is the $3d_{x^2-y^2}$ orbitals for the ladder subsystem and the $3d_{xz}$ orbitals for the chain subsystem (x refers to the crystallographic **a** direction and z to the **c** direction). The occupied orbitals are the inner orbitals that one can expect to be essentially doubly-occupied in the system and the virtual orbitals are the orbitals essentially empty in ground and low energy states of the system. The set of all determinants that can be built from all possible spin and charge arrangements within the active orbitals, all occupied orbitals being doubly-occupied and all virtual orbitals being empty, is called the Complete Active Space (CAS) and is considered as the reference space. The exact diagonalization within this space will properly treat both the open-shell character of the problem and the electronic correlation within the active or magnetic orbitals. The simultaneous optimization of the orbitals will yield the best possible partition (CASSCF procedure). Once the reference space is defined the DDCI space to be diagonalized is built from the CAS determinants and all single and double excitations on each of them except the ones that excite two occupied orbitals toward two virtual ones. Indeed, one can see easily from a perturbative analysis that at the second order the later configurations

bring only a diagonal shift and do not contribute to the excitation energies between the low energy states that essentially differ by their component on the CAS.

The DDCI method has proved to be very reliable for the study of the strongly correlated compounds, since, the use of a CAS ensures to treat properly :

1. the multi-determinantal and open-shell character of the reference wave function,
2. the correlation between the magnetic electrons,

while the selected doubly excited configurations allows to include²³

1. the screening effects (dynamical polarization and correlation) on the different configurations of the reference wave function,
2. the effects of the ligand to metal charge transfers mediating the interactions,
3. and the screening effects on the latter configurations.

One could be surprised by the importance we give to the ligand to metal charge transfer configurations, however their importance can be shown by a simple perturbative analysis of the microscopic mechanism supporting the effective exchange and transfer integrals. This mechanisms

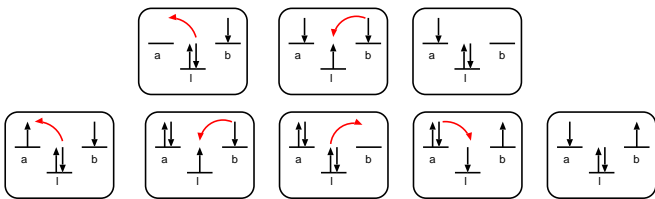

FIG. 1: Schematic representation of the microscopic mechanism responsible for the through-bridge transfer (first line) and super-exchange (second line) effective integrals between the a and b magnetic orbitals. The arrows picture the microscopic hopping involved at each step between the magnetic a or b orbitals and the ligand one, l.

lead to the classical formulation

$$\begin{aligned} t &\simeq \frac{t_{al}t_{bl}}{\Delta'} \\ J &\simeq -4\frac{t_{al}^2t_{bl}^2}{\Delta^2U} \end{aligned} \quad (1)$$

where Δ' and Δ are the ligand to metal excitation energies (let us note that these two energies are somewhat different due to the presence or absence of a spectator electron on the metal-ligand bond), U is the Coulomb repulsion in the magnetic orbitals and t_{al} , t_{bl} are the ligand to metal direct transfer integrals. One sees from figure 1 and equation 1 that in order to obtain an accurate determination of the effective transfer and exchange integrals, one should properly evaluate the ligand to metal excitation energy.

The effects of the rest of the crystal on the computed fragments are essentially the Madelung potential and the exclusion effects. Exclusion effects are treated using total-ion pseudo-potentials²⁶ (TIPs) that prevent the quantum fragment electrons to extend in regions of space normally occupied by the electrons of the rest of the crystal. In the present work TIPs²⁷ are used on the first shell of atoms surrounding the computed cluster. The Madelung potential is reproduced by a set of point charges located on the material atomic position. The charges were chosen so that the strontium and calcium atoms are di-cations (Ca^{2+} and Sr^{2+}). The copper and oxygen charges were chosen as Cu^{2+} and $O^{-2+\delta}$. The δ correction is associated to the self-doping in holes. It was attributed to the oxygens since the holes were shown to be essentially localized on them²¹. The δ values for the chain and ladder subsystems were chosen in agreement with the experimental assumptions and our previous calculations^{21,22}, that is all the holes on the chains for the $Sr_{14}Cu_{24}O_{41}$ system and one hole transfer on the ladders for the $Sr_{0.4}Ca_{13.6}Cu_{24}O_{41}$ compound. Concerning now the hole repartition within each subsystem, we have chosen an homogeneous repartition, corresponding to an average state in order not to induce localization effects due to a particular repartition. One should note that the main effect of a localization of the magnetic electrons will be a modification of the on-site orbitals energies through the Coulomb repulsion. This self-consistent effect is taken into account in this work through the inclusion of the screened NN electron repulsion in the energy curves (see figure 7). Due to screening effects, larger distance coulomb repulsion is expected to be of much weaker importance.

Two types of fragments are used in the present work :

- Cu_2O_7 fragments for the ladder legs and the ladder rungs interactions (see figures 2a and 2b),
- Cu_2O_8 for the chain-ladder interactions (see figure 2c).

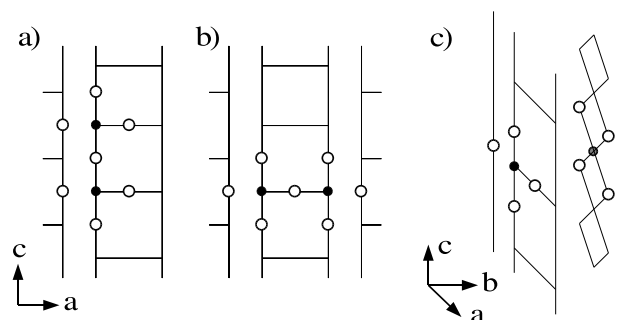

FIG. 2: Schematic representation of the computed fragments. a) for the ladder legs interactions, b) for the ladder rungs interactions and c) for the chain-ladder interactions. Circles represent the fragment atoms; the gray circles represent oxygen atoms, while the black circles represent the copper atoms.

On-site orbital energies (ε) and hopping (t) parameters of the $t - J$ model are extracted from the first doublet-doublet excitation energies, and associated wavefunctions, of the above fragments with one magnetic electron. Exchange integrals (J) are deduced from the singlet-triplet first excitation energies on the same fragments with two magnetic electrons. A least-square fit method is used in order to fit the effective parameters to the ab-initio results.

The calculations were done using the MOLCAS²⁸ and CASDI set of programs and the basis sets used can be found in reference²⁹.

In an incommensurate system all atoms or dimers have different geometries and environment. It is therefore impossible to compute all symmetry independent set of t , J , ε , etc. parameters. Indeed, the atomic positions of the present compounds are described as the three dimensional projection of a periodic four dimensional structure (for further details see reference³⁰). It comes for the atomic positions of the two subsystems

$$\vec{r}_i(p, n_x, n_y, n_z) = \vec{r}_i(p, 0, 0, 0) + \vec{R}_i(n_x, n_y, n_z) + \vec{f}(\tau_i(n_z))$$

where i refers to the subsystem and p labels the atoms in the unit cell,

$$\vec{r}_i(p, 0, 0, 0) = x_0(p)\vec{a} + y_0(p)\vec{b} + z_0(p)\vec{c}_i$$

is the atomic position of the average structure in the reference unit cell

$$\vec{R}_i(n_x, n_y, n_z) = n_x\vec{a} + n_y\vec{b} + n_z\vec{c}_i$$

is the translation vector of the average structure of each subsystem i , and $\vec{f}(\tau_i(p, n_z))$ is the modulation vector of the subsystem i with the periodicity of the other subsystem : j .

$$\tau_i(p, n_z) = (z_0(p) + n_z) \frac{c_i}{c_j}$$

and

$$\vec{f}(\tau_i(p, n_z)) = \sum_{n=1}^{n_{max}} A_{i,n}(p) \sin(2\pi n\tau_i(p, n_z)) + B_{i,n}(p) \cos(2\pi n\tau_i(p, n_z))$$

We thus computed the $t - J$ model parameters at 11 different positions along the ladders. These positions were chosen in order to get a good representation of the incommensurate distortions. The computed values were then extrapolated to the whole system using the above crystallographic description of incommensurate systems. It was done using a Fourier's series analysis, as a function of the fourth coordinate τ , associated with the incommensurate modulations³⁰. All results of this work are given as a function of the τ coordinate of the copper atom (on-site parameters) and of the copper atom of lowest x and z coordinate for the interaction terms.

III. INFLUENCE OF THE STRUCTURAL MODULATIONS ON THE LADDER SUBSYSTEM

A. $t - J + V$ model

Figure 3 displays the hopping and exchange parameters for the undoped and calcium-doped compounds. One first notices that, as was observed on the chains subsystem^{21,22}, the variations of the parameters are quite large. For instance, on the $x = 13.6$ ladder legs, the hopping modulations reach up to 160 meV. One should however point out that the nominal values of both the hopping and exchange integrals are much larger for the ladder subsystem than for the chain one due to the nearly 180° $Cu-O-Cu$ angles. In fact, this is essentially the ligand to metal charge transfer integrals of equations 1 that are sensitive to the structural modulations. In the chain subsystem one of them, let us say t_{al} , is nearly zero (due to the nearly 90° irc angles) and thus very responsive to any structural distortions. In the ladder subsystem both t_{al} and t_{bl} are large (due to the nearly 180° irc angles). The consequence is that the relative variations of the parameters are much smaller on the ladder subsystems. Indeed, even for the hopping on the ladder legs of the $Ca_{13.6}$ compound, the relative variation reaches only 22% of the nominal value, while it was 100% for the chains nearest-neighbor (NN) hoppings. It can thus be expected that despite their large absolute values, hopping and exchange fluctuations will not be as crucial for the ladders electronic structure, as for the chains subsystems one. Nevertheless one should remember that these modulations are not small enough for their effect to be negligible.

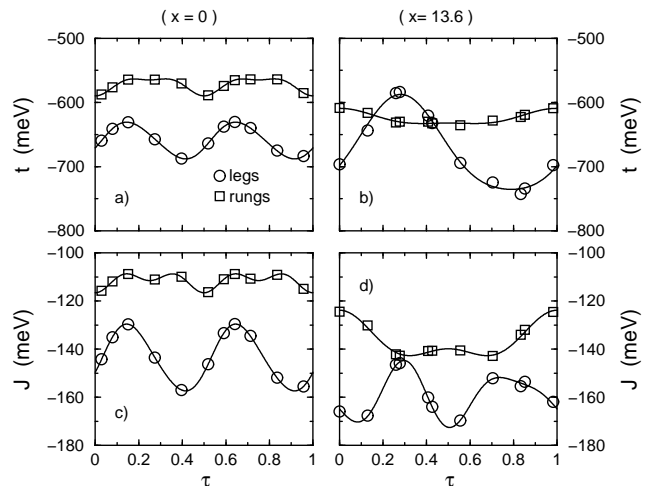

FIG. 3: Effective hopping (a and b) and exchange (c and d) parameters as a function of the modulation crystallographic coordinate τ . Figures a and c correspond to the undoped compound and figures b and d to the calcium-doped compound ($x = 13.6$). The circles and squares are the computed points for the legs and rungs, the solid line are the fitted Fourier series.

Eccleston *et al*³¹ reported exchange values extracted from neutron scattering experiments, for the undoped compound. These values of 130 meV for the ladder legs and 72 meV for the ladder rungs are to be compared with our computed mean values of respectively 143 meV and 111 meV. While the order of magnitude are in good agreement the ratio between the average rungs and legs exchange is larger in our calculations ($J_{\perp}/J_{\parallel} = 0.77$) than in the experimental evaluation (0.55). One should however notice that the J_{\perp}/J_{\parallel} evaluation from neutron scattering does not take into account the four copper cyclic exchange parameter. Matsuda *et al*³² found that the consideration of this cyclic term in the fit of the neutron scattering data of the $La_6Ca_8Cu_{24}O_{41}$ compound notably increases the a J_{\perp}/J_{\parallel} ratio, more in agreement with the present results. In addition, the cyclic exchange has been evaluated by ab-initio methods for the $SrCu_2O_3$ compound³³ and found to be 18% of the leg exchange value, in qualitative agreement with the neutrons scattering data of Matsuda *et al* which evaluate this term to 15% of the leg exchange. Another argument in favor of the quality of our calculations is the consistency between the exchange and hopping parameters, computed independently. Indeed, equation 1 yields $J_{\perp}/J_{\parallel} \simeq (t_{\perp}/t_{\parallel})^2$, while our computed average values gives $J_{\perp}/J_{\parallel} = 0.77$ and $(t_{\perp}/t_{\parallel})^2 = 0.75$.

It is interesting to notice that our calculation shows a variation of the exchange constant along the ladder legs of about 19% of the exchange average value. This result compares nicely with the predictions of Schmidt *et al*³⁴ that postulated that the structural modulations in the ladders would induce a transfer integral modulation and thus an exchange integral one. In addition, they showed that such a modulation ($\sim 16\%$ in their work) of the leg exchange values was able to explain the discrepancies observed between the Raman spectra of the $Sr_{14}Cu_{24}O_{41}$ and the $La_6Ca_8Cu_{24}O_{41}$ compounds.

One can point out that both hopping and exchange absolute values increase with the calcium content. This is specially true for the ladder rung exchange that goes from a mean value of 112 meV for the $x = 0$ compound to 136 meV for the $x = 13.6$ compound.

Figure 4 reports the on-site orbital energies, $\varepsilon(\tau)$, for the $x = 0$ (c) and $x = 13.6$ (d) compounds. One sees immediately that the variations of these on-site energies are large, however much weaker in amplitude than for the chain subsystems. Indeed, for the undoped compound, ε varies in a 0.3 eV range while it is 1.2 eV²¹ for the chain subsystem. Similarly for the $x = 13.6$ compound the variations range is 1.6 eV for the ladders while it is 2.4 eV²² for the chains. This results are in agreement with the hopping and exchange results and are due to the facts that (i) the structural modulations are of weaker amplitude on the ladder subsystem than on the chain one, (ii) the parameters modulation of one subsystem, and specifically the on-site orbital energies, are essentially due to the structural modulations of the concerned subsystem itself²¹. It is remarkable that these on-

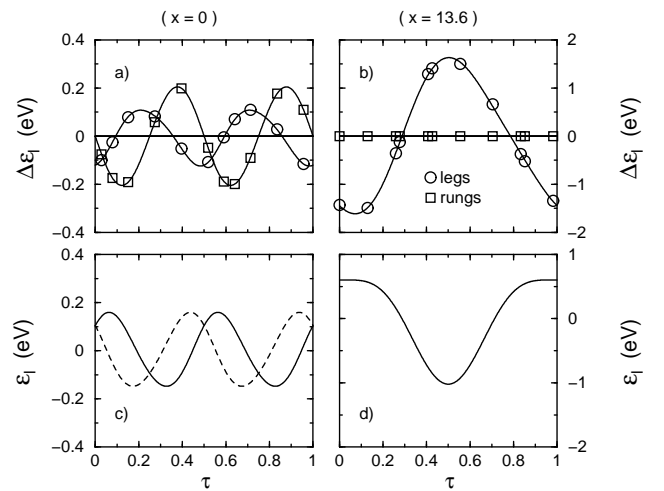

FIG. 4: On-site orbital energies differences between NN sites (a for $x = 0$ and b for $x = 13.6$). The circles correspond to the computed values on the legs fragments and the squares to the rungs ones. The lines are the fitted Fourier series. Deduced on-site energies are presented on figures c for $x = 0$ and d for $x = 13.6$. The solid and dashed curves correspond to the two legs of a ladder.

site energies modulations are totally correlated with the Madelung potential modulation, both for the chain and ladder subsystems and both for the undoped and highly calcium doped compounds (see figure 5). Indeed, despite the fact that the local environments of the ladders and chain magnetic centers are very different the computed on-site orbital energies exhibit the same dependence to the Madelung potential : $\Delta\varepsilon = 0.42\Delta V_{Mad.Pot.}$ (where $V_{Mad.Pot.}$ is the Madelung potential on the copper sites and delta refers to the NN differences).

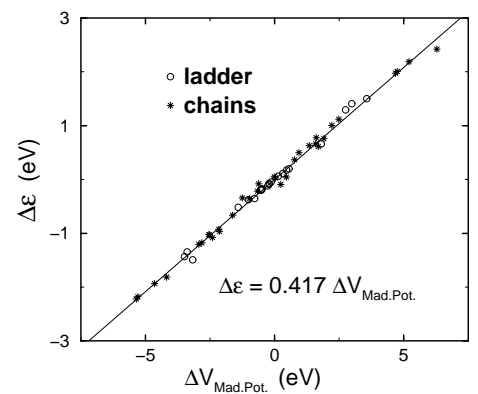

FIG. 5: Computed NN-difference of the on-site orbital energies as a function of the corresponding Madelung potential differences.

Comparing the ε values as a function of the calcium doping, one sees that as for the chain subsystem the calcium-doped compound presents much larger on site orbital energy fluctuations than the undoped system. This

difference is in fact much larger than for the chain subsystem since the $x = 13.6$ versus $x = 0$ average orbital energy ratio is 5.3 for the ladders while it is only 2 for the chains. Another important point, that will be discussed in more details later on, is the fact that the ε variation range is weaker than the hopping integral in the $x = 0$ system (0.3 eV versus 0.660 eV), while it is much larger in the $x = 13.6$ compound (1.6 eV versus 0.670 eV) and can be expected to induce in this case a hole localization on the ladders.

Another important remark concern the orbital energy difference between two sites belonging to the same rung. Indeed, for the undoped system this difference is strongly modulated, with a NN energy difference larger than between NN leg atoms (see figure 4a). For the highly doped compound however, the two copper sites of a same rung are iso-energetic. Indeed, the maximum absolute value of the computed orbital energy difference between two sites on the same rung is smaller than 1 meV. This energy degeneracy witnesses a hidden extra symmetry since the two copper sites of a rung respectively correspond to τ and $-\tau$. One retrieves this symmetry on figure 4d where the $\varepsilon(\tau)$ function is symmetric around $\tau = 0.5$. The expected consequence of such a symmetry is the fact that the holes present in the ladder subsystem should be delocalized between the two sites of the ladder rungs, while localized in the \vec{c} direction.

IV. CHAIN-LADDER INTERACTIONS

In this section we will address the possibility of a chain-ladder coupling due to the structural modulations. Indeed, as mentioned in the introduction, in the highly calcium-doped compounds, the chains can be distorted in such a way that their oxygen atoms come into an apical position of the ladder copper atoms with a small $Cu_{ladder}-O_{chain}$ distance (2.7 Å). In the undoped compound however, the $Cu_{ladder}-O_{chain}$ distances always remain larger than 3.1 Å.

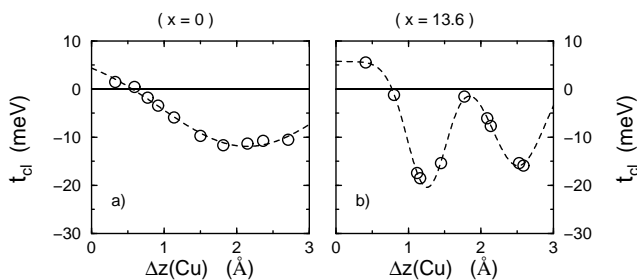

FIG. 6: Effective hopping between the chain and ladder closest copper sites as a function of the difference between the two copper coordinates along the \vec{c} axis ($\Delta z(Cu)$). Circles represent the computed points and the dashed lines are a guide for the eyes.

Figure 6 displays the effective hopping integrals be-

tween chain and ladder closest copper sites. One sees immediately that unlike what has been supposed in the literature, the chain-ladder hopping terms remain weak whatever the $Cu_{ladder}-O_{chain}$ distances. Indeed, both the nominal values and the variation ranges (in meV units : $[-11.7, 1.5]$ for the $x = 0$ system and $[-18.5, 5.5]$ for the $x = 13.6$ compound) are of the same order of magnitude for the undoped and calcium-doped compounds.

We also computed the chain-ladder magnetic couplings and the on-site orbital energy differences between the chain and ladder systems. The effective exchange were always found weaker than 1 meV, that is negligible. As far as the chain-ladder orbital energy differences are concerned, the results obtained from the present chain-ladder fragments are in full agreement with the results presented on the ladder subsystems and those from references^{21,22} on the chain subsystems. One should point out that the present calculations allow us to set the chain-ladders relative energy levels, as will be discussed further. Let us also notice that the orbital energy differences between chain and ladder sites are not proportional to the Madelung potential differences on the related sites, unlike what was observed for the intra-subsystems orbital energy modulations (see figure 5).

One should notice at this point, that counter ions were not included in the fragment since their effects were expected to be smaller than the contribution due the $Cu-O-Cu$ path. Their contributions indeed involve $Cu-O-Ca/Sr-O-Cu$ path with $Ca/Sr-O$ distances larger than 2.4 Å. As the obtained values of the interactions are very small, their effects could be not totally negligible. Nevertheless, if the inclusion of the counter ions could slightly modify the values of the interactions, it will not change the main conclusion which is that the ladder-chain interactions are largely smaller than the intra-chain or intra-ladder interactions. Both hopping and exchange values are found more than one order of magnitude weaker. The chain and ladder layers can thus be safely considered as non-interacting.

V. DISCUSSION AND CONCLUSION

One of the most controversial subject about the $Sr_{14-x}Ca_xCu_{24}O_{41}$ family of compounds is the chain to ladder hole transfer as a function of the calcium content. While it is clearly established that the hole transfer increases both with the calcium content and the applied pressure, the actual amount of transferred holes does not reach a consensus, even for the $x = 0$ system. This subject is of importance for the understanding of the system properties since (i) it is supposed to be crucial for the superconducting phase³ and (ii) it is more generally directly related to the systems conduction properties since the conduction is supposed to occur in the ladder subsystem.

In such a compound, the localization of the electrons will mainly arise from (i) the modulation of the on site

energies due to structural modulations (ii) the correlation between magnetic electrons. A full treatment of this many body problem in an incommensurate system, is beyond the aim of this work, since it focuses on the role of the structural distortions. Moreover, the variations of the orbital energies are very large compared to the other parameters of this model. In the following, we will thus consider only the very first effect of electrons interactions, by including NN repulsions. This approach will already give indications on the role of the distortions on the electron localization, and transfer.

We evaluated the relative energy of the chain and ladder subsystems, responsible for the possible hole transfer, from the following parameters :

- the on-site orbital energies,
- the NN bi-electronic repulsion in the chain, the NN and NNN bi-electronic repulsion in the ladder.

In references^{21,22}, the NN bi-electronic repulsion V was computed for the chain subsystem using three centers fragment calculations. It was found to be almost independent of the structural modulations, temperature and calcium content. This can be understood by the fact that the NN repulsions are essentially dependent on the $Cu-Cu$ distances and not on the $Cu-O-Cu$ angles that dominate the modulations of the other effective interactions. We thus evaluated the NN repulsions on the ladders subsystem using the average computed chain value of 0.6 eV and the standard Ohno formula³⁵ for the distance dependence

$$V(R) = \frac{V_0}{1 + R/a_0}$$

where R is the inter-site distance, a_0 is the Bohr radius and V_0 a $R = 0$ effective constant. Extracting V_0 from the chain repulsions we get $V_0 = 3.7$ eV. We thus find

- for the intra-ladder repulsions : $V_{leg} \simeq V_{rung} \simeq 0.44$ eV, and $V_{diag} \simeq 0.32$ eV (diagonal repulsion on a plaquette),
- for the inter-ladder repulsions : $V_{leg-leg} \simeq 0.6$ eV.

Using these approximations and the computed orbital energies we determined the relative energies of the chains and ladders as a function of τ (see figure 7). Since the ladder hole-doping remains small we considered that the repulsions were acting on all ladder sites. As a matter of comparison we computed the mean (periodic approximation) relative energy between the ladder and chain sites using the same method. We found for the $x = 0$ undoped compound the chains about 0.5eV above the ladders while for the $x = 13.6$ compound the chain and ladders subsystems are quasi-degenerate. For the real compounds, one can see on figure 7 that while for the $x = 0$ compound the ladder energy curve is always about 0.65 eV lower than the first empty sites of the chains, for the $x = 13.6$ compound, the most energetic ladder sites

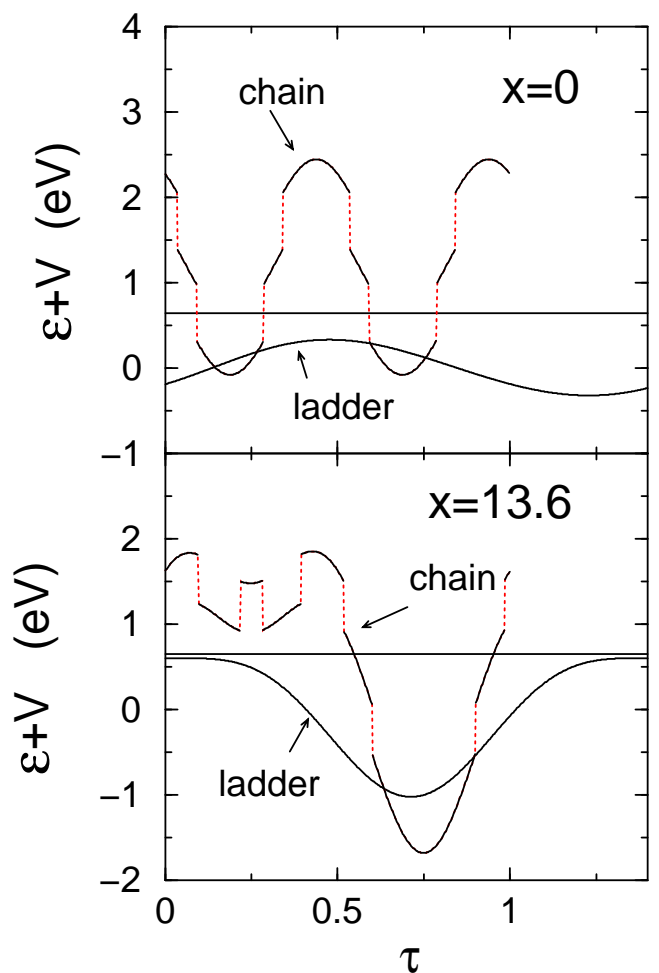

FIG. 7: Chain and ladder energies as a function of τ_{chains} . The site energies were evaluated as the sum of the orbital energies and the repulsion terms with neighboring atoms when the latter have lower orbital energies and are thus occupied prior to the considered one. The ladder fourth coordinate τ_{ladder} has been rescaled to $2c_{chain}/c_{ladder}$, so that the relative τ variation range of the two subsystems is proportional to the number of sites per f.u. in each sub-system. The horizontal line represents the Fermi level.

are at the Fermi level. These results are coherent with a complete hole localization on the chain sub-system for the undoped compound and a small hole transfer to the ladders for highly doped systems. It seems however difficult to extract a precise value of the chain to ladder hole transfer (for the $x = 13.6$ compound). Indeed the hole transfer can be expected to be sensitive to very small energetic variations, since the Fermi level is located in a region with large density of states, both for the chain and ladder subsystems. For the ladders subsystem, E_F is located on an energetic plateau. For the chain subsystem, E_F crosses the energy curve, unlike what happens in the undoped system where the Fermi level is located in an energetic gap. This may explain the large experimental

range of values obtained for this hole transfer.

Another consequence of the Fermi level localization on a ladders energetic plateau, is that the holes are localized on (quasi) iso-energetic rungs — while they are localized on very energetically different sites in the chain subsystem. These rungs are not first neighbors, but in most cases second and in some cases third neighbors. The holes can thus be considered as evolving on a subset of the ladders with (quasi) iso-energetic sites. In such a model, the rungs belonging to the real ladder located in between two hole-supporting rungs can be considered as bridging ligands. The resulting effective hopping and exchange integrals between the hole-supporting rungs are thus modulated according to the number and the characteristics of these in-between rungs. In such a model, these effective interactions between hole-supporting rungs can be expected to be rescaled to much lower values than the NN ones on the real ladder, and thus much lower values than the on-rung ones ($|t_{\text{leg}}^{\text{eff}}| \ll |t_{\text{rung}}|$ and $|J_{\text{leg}}^{\text{eff}}| \ll |J_{\text{rung}}|$).

We would like to conclude this work on a few opened questions on the super-conducting phase. First, the on-site energy variations are quite-large on the calcium-doped system, both for the chains and ladders subsystems. These modulations strongly increase as a function of the chemical pressure. Whether the applied pressure would act along the same line, it would induce an even larger distortion of the chains and ladders subsystems. Such a phenomenon would be quite incompatible with the usual super-conductivity theory in the ladder systems since it would induce an even larger modulation of the ladder on-site orbital energies. Another discrepancy between the present results and the super-conductivity predictions is that the super-conductive pairing is supposed to occur for (i) low ladder hole doping, (ii) $2|J_{\text{rung}}| > |J_{\text{leg}}|$ (both are verified in the present case) and (iii) $|J_{\text{rung}}| > |t_{\text{rung}}|$ which is far from being verified since $|t_{\text{rung}}| > 4|J_{\text{rung}}|$. One thus wonder either what type of structural distortions under applied pressure could correct these features hindering the super-conductivity or whether the observed super-conductivity arise from another origin that the usually accepted homogeneous ladder $t - J$ model.

Acknowledgments : the authors thank Dr. J. Etrillard for providing us with the undoped compound crystallographic structures, Dr. Maynau for providing us with the CASDI code. The present calculations were done at the CNRS/IDRIS computational facilities under project n 1104.

Appendix

The computed results were fitted as a function of the fourth crystallographic coordinate τ , using a Fourier series, according to the following expression

$$a_0 + \sum_n a_n \cos [2\pi n(\tau - \varphi_n)] \quad (2)$$

(a)						
$x = 0$	ε_l	$\Delta\varepsilon_r$	t_l	t_r	J_l	J_r
a_0	0.0	0.0	-659.2	-572.2	-143.9	-111.6
a_1	-153.0	204.3	28.3	12.4	-13.7	2.5
a_2	8.9	3.4	2.0	-5.1	-1.0	-2.5
φ_1	0.819	0.875	0.655	0.750	0.904	0.750
φ_2	0.786	0.688	0.089	0.500	0.982	0.500
(b)						
$x = 13.6$	ε_l	$\Delta\varepsilon_r$	t_l	t_r	J_l	J_r
a_0	0.0	0.0	-672.5	-624.7	-159.3	-136.4
a_1	-811.4		73.9	11.5	-0.2	8.0
a_2	-209.5		-11.1	4.0	-10.5	4.5
a_3					4.4	
φ_1	0.500	0.000	0.284	0.001	0.284	0.995
φ_2	0.004	0.000	0.529	1.000	0.537	0.997
φ_3					0.972	

TABLE I: Analytic fit of the $t - J$ model, a) for the $x = 0$ undoped compound, b) for the $x = 13.6$ calcium-doped compound. All energies are given in meV.

Only terms with a non negligible contribution to the series were retained.

The results are summarized in tables Ia for the $x = 0$ and Ib for $x = 13.6$.

-
- ¹ M. Uehara, T. Nagata, J. Akimitsu, H. Takahashi, N. Mori, K. Kinoshita, *J. Phys. Soc. Jap.* **65**, 2764 (1996) ; T. Nagata, M. Uehara, J. Goto, J. Akimitsu, N. Motoyama, H. Eisaki, S. Uchida, H. Takahashi, T. Nakanishi and N. Mri, *Phys. Rev. Lett.* **81**, 1090 (1998).
- ² M. McCarron, M.A. Subramanian, J.C. Calabrese and R.L. Harlow, *Mater Res. Bull.* **23**, 1355 (1988).
- ³ E. Dagotto, J. Riera and D. Scalapino, *Phys. Rev.* **B 45**, 5744 (1992) ; M. Sigrist, T. M. Rice and F. C. Zhang, *Phys. Rev.* **B 49**, 12058 (1994) ; H. Tsunetsugu, M. Troyer and T. M. Rice, *Phys. Rev.* **B 49**, 16078 (1994).
- ⁴ N. Nücker, M. Merz, C.A. Kuntscher, S. Gerhold, S. Schuppler, R. Nuedert, M.S. Golden, J. Fink, D. Schild, S.

- Stadler, V. Chalarian, J. Freeland, Y.U. Idzerda, K. Conder, M. Uehara, T. Nagata, J. Goto, J. Akimitsu, N. Motoyama, H. Eisaki, S. Uchida, U. Ammerahl, and A. Revcolevschi, *Phys. Rev.* **B 62**, 14384 (2000).
- ⁵ T. Osafune, N. Motoyama, H. Eisaki, and S. Uchida, *Phys. Rev. Lett.* **78**, 1980 (1997).
- ⁶ C. A. Hayward, D. Poilblanc, R. M. Noack, D. J. Scalapino and W. Hanke, *Phys. Rev. Letters* **75**, 926 (1995).
- ⁷ A. Gellé and M.-B. Lepetit, *Phys. Rev. Letters* **92**, 236402 (2004).
- ⁸ J. Etrillard, M. Braden, A. Gukasov, U. Ammerahl, A. Revcolevschi, *Phys. C Supercond.* **403**, 290 (2004).
- ⁹ M. Isobe, M. Onoda, T. Ohta, F. Izumi, K. Kimoto and

- E. Takayama-Muromachi, *Phys. Rev. B* **62**, 11667 (2000).
- ¹⁰ See for instance : W.E. Pickett, *Rev. Mod. Phys.* **61**, 433 (1989) ; I. de P.R. Moreira and F. Illas, *Phys. Rev. B* **60**, 5179 (1999).
- ¹¹ B. Keimer, N. Belk, R.J. Birgeneau, A. Cassanho, C.Y. Chen, M. Greven, M.A. Kastner, A. Aharony, Y. Endoh, R.W. Erwin and G. Shirane, *Phys. Rev. B* **46** 14034 (1992).
- ¹² D. Muñoz, F. Illas and I. de P.R. Moreira, *Phys. Rev. Letters* **84**, 1579 (2000) ; D. Muñoz, I. de P.R. Moreira and F. Illas, *Phys. Rev. B* **65**, 224521 (2002).
- ¹³ A.N. Yaresko, A.Y. Perlov, R. Hayn and H. Rosner, *Phys. Rev. B* **65** 115110 (2002).
- ¹⁴ M.S. Hybertsen, E.B. Stechel, M. Schluter and D.R. Jenison, *Phys. Rev. B* **41**, 11068 (1990).
- ¹⁵ M. Arai and H. Tsunetsugu, *Phys. Rev. B* **56**, R4305 (1997).
- ¹⁶ C. Schuster and U. Schwingenschlgl, communication at the ESF Workshop on Highly Frustrated Magnetism (HFM), novembre 7-9, 2005, Agelonde, La Londe Les Maures, France.
- ¹⁷ J. Miralles, J. P. Daudey and R. Caballol, *Chem. Phys. Lett.* **198**, 555 (1992) ; V. M. García *et al.*, *Chem. Phys. Lett.* **238**, 222 (1995) ; V. M. García, M. Reguero and R. Caballol, *Theor. Chem. Acc.* **98**, 50 (1997).
- ¹⁸ N. Suaud and M.-B. Lepetit, *Phys. Rev. B* **62** 402 (2000) ; N. Suaud and M.-B. Lepetit, *Phys. Rev. Letters* **88**, 056405 (2002).
- ¹⁹ I. de P.R. Moreira, F. Illas, C. Calzado, J.F. Sanz J.-P. Malrieu, N. Ben Amor and D. Maynau, *Phys. Rev. B* **59**, R6593 (1999).
- ²⁰ C.J. Calzado and J.P. Malrieu, *Eur. Phys. J. B* **21**, 375 (2001).
- ²¹ Alain Gellé and Marie-Bernadette Lepetit, *Eur. Phys. J. B* **46**, 489 (2005).
- ²² Alain Gellé and Marie-Bernadette Lepetit, *Eur. Phys. J. B* **43**, 29 (2005).
- ²³ C.J. Calzado, J.F. Sanz and J.P. Malrieu, *J. Chem. Phys.* **112**, 5158 (2000).
- ²⁴ M.-B. Lepetit, *Recent Research Developments in Quantum Chemistry*, p. 143, Vol. 3, Transworld research Network (2002).
- ²⁵ F. Illas, I. de P.R. Moreira, C. de Graaf, O. Castell and J. Casanovas, *Phys. Rev. B* **56**, 5069 (1997).
- ²⁶ N. W. Winter, R. M. Pitzer and D. K. Temple, *J. Chem. Phys.* **86**, 3549 (1987).
- ²⁷ Sr : W.R. Wadt and P.J. Hay, *J. Chem. Phys.* **82**, 284 (1985) ; Ca : J.L.Pascual, L.Seijo, Z.Barandiaran, *J.Chem.Phys.* **98**, 9715 (1993).
- ²⁸ G. Karlström, R. Lindh, P.-Å. Malmqvist, B. O. Roos, U. Ryde, V. Veryazov, P.-O. Widmark, M. Cossi, B. Schimmelpfennig, P. Neogrady, L. Seijo, *Computational Material Science*, **28**, 222 (2003).
- ²⁹ The calculations have been performed using the CASDI suite of programs provided of D. Maynau. The basis set and core effective potentials used can be found in : Z. Barandiaran and L. Seijo, *Can. J. Chem.* **70**, 409 (1992).
- ³⁰ P.M. de Wolff, *Acta Cryst. A* **30**, 777 (1974) ; A. Yamamoto, *Acta Cryst. A* **52**, 509 (1996).
- ³¹ R.S. Eccleston, M. Uehara, J. Akimitsu, H. Eisaki, N. Motoyama, and S. Uchida, *Phys. Rev. Lett.* **81**, 1702 (1998).
- ³² M. Matsuda, K. Katsumata, R.S. Eccleston, S. Brehmer and H.-J. Mikeska, *Phys. Rev. B* **62**, 8903 (2000).
- ³³ C. de Graaf, I. de P. R. Moreira, F. Illas and R. L. Martin, *Phys. Rev. B* **60**, 3457 (1999).
- ³⁴ K.P. Schmidt, C. Knetter, M. Grüninger and G.S. Uhrig, *Phys Rev. Letters* **90**, 167201 (2003).
- ³⁵ K. Ohno *Theor. Chim. Acta* **2**, 219 (1964).