



HAL
open science

Two-photon Ramsey fringes at 30 THz referenced to an H Maser / Cs fountain via an optical frequency comb at the 1 Hz level.

Alexander Shelkovnikov, Christophe Grain, Robert James Butcher, Anne Amy-Klein, Andréi Goncharov, Christian Chardonnet

► To cite this version:

Alexander Shelkovnikov, Christophe Grain, Robert James Butcher, Anne Amy-Klein, Andréi Goncharov, et al.. Two-photon Ramsey fringes at 30 THz referenced to an H Maser / Cs fountain via an optical frequency comb at the 1 Hz level.. IEEE Journal of Quantum Electronics, 2004, 40, pp.1023-1029. hal-00003121

HAL Id: hal-00003121

<https://hal.science/hal-00003121>

Submitted on 21 Oct 2004

HAL is a multi-disciplinary open access archive for the deposit and dissemination of scientific research documents, whether they are published or not. The documents may come from teaching and research institutions in France or abroad, or from public or private research centers.

L'archive ouverte pluridisciplinaire **HAL**, est destinée au dépôt et à la diffusion de documents scientifiques de niveau recherche, publiés ou non, émanant des établissements d'enseignement et de recherche français ou étrangers, des laboratoires publics ou privés.

Two-photon Ramsey fringes at 30 THz referenced to an H Maser / Cs fountain via an optical frequency comb at the 1 Hz level.

Alexander SHELKOVNIKOV, Christophe GRAIN, Robert J. BUTCHER, Anne AMY-KLEIN, Andréi GONCHAROV and Christian CHARDONNET

Abstract—Aspects of two-photon Ramsey fringes in SF₆ at 30 THz obtained with a 1m separation between the two absorption zones are presented. The experiment is referenced to a primary standard, the Hydrogen maser / Cs fountain located at BNM-SYRTE, via a femtosecond laser frequency comb generator. This results in a stability below 1 Hz for 1000 s of averaging, and absolute frequency measurements to ± 2 Hz which corresponds to 6×10^{-14} in relative frequency. Resolution of the hyperfine structure now approaches 10 Hz, while the fringe period of 200 Hz provides a frequency discriminator 100 times narrower than any other currently in use in the spectral region.

Index Terms— Carbon dioxide lasers, Frequency stability, SF₆, Optical frequency standard.

I. INTRODUCTION

The carbon dioxide laser has given to the 30 THz spectral region particular significance in frequency metrology. The current standard at 30THz is provided by the CO₂ laser locked onto a saturated absorption resonance of OsO₄ in a cell, the reference signal having full width half maximum (FWHM) of 20 kHz [1, 2]. The same area is particularly rich in molecular spectra and many problems in this area, together with questions of fundamental physics, have been investigated using the related saturation spectroscopy [3, 4]. Typical linewidths are 1-100 kHz. This paper presents continuing work on a two-photon Ramsey fringe experiment on a supersonic beam of SF₆ with the objectives, now essentially realized, of resolving the entire complex hyperfine structure over some 50 kHz and establishing absolute frequencies at the 1Hz level. Both aspects represent huge advances over cell saturation techniques.

Two experimental developments have led to the recent advances. First, the distance between the absorption zones has been increased to 1m, so that the fringe periodicity is now 200 Hz for pure SF₆. Data is routinely recorded with a signal-to-noise ratio (SNR) of 20 in a bandwidth of 1 Hz. The implied limit on the resolution of two components within the hyperfine structure of the SF₆ spectrum is only 10Hz. This is indeed found when fringe patterns are fitted. Second the entire system can now be directly related to the frequency comb of a femtosecond laser, itself referenced to a Hydrogen maser. The maser is compared to a Caesium fountain and to the GPS system. This gives a long-term stability and frequency reproducibility limited by the performance of the current electronics, various optical links and, possibly, the reference maser. The fs technology is necessarily operated in a new area of precision, comparable with the best currently in use [5, 6]. Figure 1 gives a block outline of the entire experiment.

Two related series of experiments are presented. First the central Ramsey fringe is employed as the reference point for a molecular clock; the clock frequency is measured, and its performance established, relative to the H maser. Second, and separately, Ramsey fringes are measured on an absolute frequency scale provided by the H maser. This gives a second measurement of the central fringe and the entire spectrum of Ramsey fringes over 50 kHz is put onto an absolute frequency scale.

This work is partly directed at a new frequency standard. Since a two-photon transition is used the absolute frequency depends on the optical power. Given the absolute scale, this small effect can be investigated and results are reported.

Manuscript submitted 11 September 2003. This work was carried out at the Laboratoire de Physique des Lasers, UMR 7538 C.N.R.S. Université Paris 13, 99 av. J.-B. Clément, 93430 Villetaneuse, France, and was supported in part by the Bureau National de Métrologie, C.N.R.S., Université Paris 13 and Gonville and Caius College, Cambridge.

Ch. Grain, A. Amy-Klein, and Ch. Chardonnet :Tel: 33 1 49 40 33 92, Fax: 33 1 49 40 32 00, e-mail : amy@lpl.univ-paris13.fr.

A. Shelkovnikov is also with P.N.Lebedev Physical Institute, Leninsky Prospect, 53, Moscow, 117924, Russia (e-mail : shelkov@x4u.lebedev.ru).

R.J. Butcher is also with The Cavendish Laboratory, Madingley Road, Cambridge CB3 0HE, UK (e-mail : rjb2@cus.cam.ac.uk).

A. Goncharov is also with The Institute of Laser Physics, Siberian Branch of the Russian Academy of Science, Pr. Lavrentyeva 13/3, 630090 Novosibirsk, Russia

II. THE TWO-PHOTON RAMSEY FRINGE EXPERIMENT

The two-photon Ramsey fringe experiment employing a supersonic beam of SF₆ has been developed over number of years and is already described in some detail [7-10]. In brief, the molecular beam interacts successively with two standing waves, which are tuned to a two-photon resonance. The excitation probabilities for the two zones of interaction interfere so that the population of the upper level oscillates with a periodicity P which depends on the transit time between the two zones : $P = u/\sqrt{2D}$, where u is the mean velocity of the beam and D the distance between zones. In order to obtain the central fringe in exact coincidence with the two-photon resonance the relative phase of the two standing waves must cancel. This is ensured by using a single folded Fabry-Perot cavity, comprising four mirrors in a U configuration [11]. The two-photon transition is the P(4)E⁰ line of the 2ν₃ band of SF₆, excited by the P(16) CO₂ laser line. This is particularly favorable because of its low J value and because of the enhancement due to the near-resonant intermediate transition, P(4) ν₃. Fringes in the two-photon absorption are detected by stimulated emission in a separate Fabry-Perot cavity. For this purpose the laser beam used for detection is strongly modulated in order to sample the whole Doppler profile. This technique has been described earlier [10], and is crucial in obtaining a good SNR.

The current experiment incorporates a new folded cavity with a separation of 1 m between absorption zones. This was mounted in a cylindrical invar structure and surrounded, as before, by a μ-metal shield to eliminate the Zeeman effect in the earth's magnetic field. The cavity is particularly susceptible to vibrations for two reasons. First, modulation frequencies must be low in order to record fringes at 200 Hz separation. Second, the size of the invar structure implies that its vibrational modes will be easily excited at these low frequencies. Thus the structure was supported using molybdenum wire, this material being chosen for its low Young modulus, while resting just in contact with the vacuum chamber via rubber shock absorbers. This chamber was further braced, after discovering its distortion under vacuum and in order to displace its normal modes of vibration. Optimum operation was obtained by frequency modulating Laser 2 (Figure 1) at 115 Hz with an index of 0.43, 12 mW in the U cavity, corresponding to a π/2 pulse, and 75 μW in the detection cavity.

Two CO₂ lasers are employed on the 10μm P(16) transition. The first is locked to the P(55) line in OsO₄ while the second is phase locked to the first with a radio frequency offset. The spectral purity for the whole experiment is thus determined by the first laser, while the second confers tunability under computer control. An electro-optic and three acousto-optic modulators are incorporated to shift the laser frequencies to the exact points required and to introduce various modulations [2, 10]. The clean phase modulation introduced at the electro-optic is notably significant for the quality of the OsO₄ lock [2].

In obtaining the highest resolution the most critical component is the first laser locked to OsO₄. To obtain fringes of periodicity 200 Hz at good contrast a stability of better than 20 Hz is required, which is difficult to obtain starting from a reference of FWHM 20kHz. The most significant requirement is spectral purity over times of order 1s, which can certainly be obtained using OsO₄ as the discriminant [1, 2]. Stability, however, is also required over longer times, 100s and more for data collection and averaging. The OsO₄ lock now reaches its limit and an additional active long-term stabilisation is clearly necessary. This has now been implemented by using a femtosecond comb.

Figure 2 shows an example of a recording of the central fringes as obtained using a beam of pure SF₆, generated from a reservoir pressure of 5×10⁵ Pa, 10 scans of 200 data points, lock-in time constant 100 ms. The fringe periodicity is 200 Hz and the SNR is 20. The recording is thus obtained in less than 4 minutes, using 1 second of averaging per point. The notably high SNR reflects a combination of patient attention to detail and a particularly stable laboratory environment.

III. ABSOLUTE FREQUENCIES AND LONG-TERM STABILISATION

A. The fs comb

The principle of frequency measurements using a femtosecond laser comb has been widely described [5, 6, 12], and the specific technique used in this experiment was initially employed in the measurement of an OsO₄ frequency, as recently published in detail [13]. A mode-locked Ti:Sa laser produces a train of fs pulses. Equivalently in the frequency domain these comprise a comb of modes spaced by frequency f_{rep} , which is also the repetition rate of the pulses and depends on the length of the fs cavity. The CO₂ laser frequency is smaller than the span of the modes of the fs cavity, and this can be exploited so that the CO₂ laser controls the separation between two of these modes.

The basic technique is shown in Figure 3. The laser diode at 852 nm is phase locked to a fs mode. The sum of the diode and CO₂ frequencies is generated in a crystal of AgGaS₂ and a second laser diode, at 788 nm, is phase locked to the sum. Finally a second fs mode is phase locked to the diode at 788 nm by feeding back to the fs cavity length. The phase lock loops include division ratios of 4 and 64 to increase their dynamic ranges and, with the notation of Figure 3, the frequencies are related as:

$$f(\text{CO}_2) = qf_{\text{rep}} \pm \Delta_1 \pm \Delta_2.$$

The repetition rate, f_{rep} , can be measured by directing part of the fs laser output onto a high-speed diode, and comparing the output with the frequency of another synthesizer. The primary datum measured is f_{rep} . The integer q (approx. 28400) and the signs are established unambiguously because the CO₂ frequency is already well known. In the experiments discussed below $f(\text{CO}_2)$ is the carrier frequency of the CO₂ laser (1) which is locked indirectly to OsO₄ via an acousto-optic and an electro-optic

modulator [2].

A counter with 1 s gate is used to measure f_{rep} . A computer then calculates the mean frequency and the Allan deviation from a long series of 1 s gate measurements. At the end of the measurement procedure the few points with frequencies differing by more than $\sim 10\sigma$ from the mean frequency, where σ is the standard deviation for a 1 s measurement, were removed. The number of such points is very small, 0-3 per 1000 data points.

All nine synthesizers and the reciprocal frequency counter employed in this experiment are referenced to a 100 MHz standard generated at BNM-SYRTE. This standard is generated from a hydrogen maser, itself compared to a Cs fountain [14]. The 100 MHz signal arrives at LPL via 43 km of optical fibre as amplitude modulation on a 1.55 μm carrier generated by a laser diode. It is divided down and used to phase lock the harmonic of a 5 MHz quartz oscillator, which thus provides the 10 MHz reference for the synthesizers and counter. The relative Allan deviation of this system is a few 10^{-13} for 1s [13].

B. Lock to the central SF_6 fringe, a Molecular Clock.

To measure the central fringe and to characterise the potential performance of the apparatus as a frequency standard, the central SF_6 fringe was employed as a discriminant. The OsO_4 continued to act as a fast discriminant to narrow the laser line while the absolute frequency was controlled by the SF_6 fringe. This system is entirely comparable to prestabilisation using a Fabry-Perot cavity, the OsO_4 line, FWHM 20 kHz, being equivalent to a Fabry-Perot resonance. Laser 1 is pre-stabilised onto the OsO_4 signal, while laser 2 follows laser 1 faithfully because of the phase lock. The error signal recorded by laser 2 relative to the SF_6 fringe is then used to apply a long-term correction, typical time constant 10s, to laser 1. Logging of f_{rep} thus indirectly measured the central SF_6 fringe. The result of 21 experiments of this type, over a period of 3 months, gives a central frequency and experimental standard deviation of:

$$\nu(SF_6, P(4) E^0, \text{central fringe}) = 28\,412\,764\,347\,322.1 \pm 2.7 \text{ Hz}$$

At the same time the Allan deviation can be obtained, and an example of this for times up to 1000s is shown in Figure 4. The most interesting point is that the Allan deviation has not reached an obvious plateau or started to rise again even at 1000s. The deviation is 5×10^{-13} at 1s and, initially, there seem to be two obvious contributions: The SF_6 fringe which has a predicted deviation of 8×10^{-14} at SNR=20 and the 100 MHz signal derived from the H Maser for which the measured figure is $8 \cdot 10 \times 10^{-14}$. However, when two synthesizers are compared directly, always referenced to the maser, the Allan deviation is similar to Figure 4 at 1 s¹. Thus there are limitations in the current measurement system and electronics which are very significant and mask the ultimate performance of the SF_6 lock.

The principal factors that might contribute to the error of ± 2.7 Hz are electronic offsets in the lock loops, baseline offset due to the underlying two-photon absorption, and limitations in the measurement chain.

IV. ABSOLUTE FREQUENCY MEASUREMENT OF THE SYSTEM OF SF_6 FRINGES

A. Absolute Frequency Scale

The CO_2 reference laser, (1) in Figure 1, was phase locked by comparing the repetition frequency f_{rep} with a synthesized frequency and using the error signal in a slow feedback loop PLLa of Figure 1, time constant approximately 10s, to the CO_2 laser (1). This provided the absolute frequency scale while the OsO_4 acted as a fast discriminant to narrow the laser line. The fringe spectrum could then be scanned by computer control of the frequency of synthesizer 1 in the phase lock connecting the two CO_2 lasers.

B. Spectra

The hyperfine spectrum was recorded in 12 sections, each of 4 kHz, using a lock to the fs comb as described above. Various different locks were used and parts of the spectrum were repeated on different days with different conditions in the lock electronics. From the range of data obtained the relative frequencies reproduce to 2 Hz or better. Figure 5 presents the total span of 48 kHz, which revealed a total of 36 resolved components. The number anticipated is large and there is some current problem in reducing this data to molecular properties.

The signature of a single isolated hyperfine component should be:

$$\left[1 + C \cdot \cos\left(2\pi \frac{\nu - \frac{\nu_{eg}}{2}}{P}\right) \right] \exp \left[- \left(\frac{\nu - \frac{\nu_{eg}}{2}}{2 \left(\frac{u}{\Delta u} \right) \cdot P} \right)^2 \right]$$

¹ Since the frequency is counted with 1 s gate, due to dead time we can not reconstruct the true Allan deviation of the synthesizers, depending on the inverse of time [15]

on a very broad background from the normal Doppler-free two photon absorption. C is the contrast, $h\nu_{eg}$ the two-photon energy, v the frequency of Laser 2, u is the mean beam velocity and Δu its dispersion. The exponential term is required because the beam velocity has a dispersion. All the spectra can be fitted very satisfactorily to the derivative of this equation, as anticipated for FM detection, with a single fringe period and velocity dispersion. It is very important to make systematic fits as the relation to the individual transitions is essentially a Fourier problem and it is very easy to miss transitions in a superficial inspection. Figure 6 shows details of the central part of the fringe structure, over 1.5 kHz, and the quality of typical fits obtained.

C. Measurement of the central fringe

The central fringe was measured by alternating 5 up- and 5 down-scans of 500 Hz over the central fringe. 200 data points were recorded with a lock-in time constant of 0.1s, thus giving an averaging of 1s in a measurement lasting 200s. Some 80 measurements were made, over 4 months, with a variety of experimental conditions. Simultaneously, the performance of the system was monitored by logging the frequency of the counter, Figure 1, and building up the Allan deviation. The 80 individual measurements comprised 24 groups, each group consisting of successive measurements without any changes of experimental conditions. For maximum fringe signal, which corresponds to a pulse of $\pi/2$ in the absorption, the absolute frequency is:

$$\nu(\text{SF}_6, P(4) E^0, \text{central fringe}) = 28\,412\,764\,347\,323.0 \pm 1.4 \text{ Hz}$$

which is in close agreement with the clock measurement above. The histogram in Figure 7a shows the dispersion in the mean with $\sigma=1.4$ Hz.

A different way to consider the precision of the data is to analyse the deviations in each group of measurements. This helps to remove systematic effects from day to day and is a better estimator of the potential SF₆ accuracy. Thus, Figure 7b shows a composite of the accumulated dispersion about the mean within each set of measurements. Clearly the statistic is nearer to a normal distribution, as expected for random errors. The second dispersion is reduced, $\sigma=0.6$ Hz, and the inference is that there is a significant systematic component; we have not yet reached the limit imposed by the SF₆ fringes.

The measurement technology is thus being pushed close to its limits, both in frequency measurements and in diagnostics. The limit is not yet in the performance of the Ramsey fringe experiment. The critical link in the frequency chain is the synthesizer 2 in Figure 1. This is referenced at 10MHz and operates at 1GHz, a frequency which must then be multiplied by 28400 to reach the CO₂ frequency. The relative precision in the 1GHz frequency is required to be better than the fringe precision; but at the moment this is clearly not the case. In addition there is a question of phase noise on the fibre link to BNM-SYRTE. As monitored, the phase fluctuations and drifts in the optical link certainly result in significant frequency shifts, although these are below 1 Hz under our experimental conditions. Further the fs system is being used at the level of 1 Hz, a level of precision where satisfactory operation is non-trivial. There are also numerous nuances of alignment and power levels, although it might be noted that many parts of the experiment have been disassembled and re-mounted in the course of these measurements. There thus clearly remains a range of modifications and careful work to realize the ultimate performance.

V. LIGHT SHIFT

A light shift is always present in a 2-photon transition and bears directly on the metrological aspects of this experiment as it might be significantly large and certainly varies with power. It is a simple example showing the impossibility of separating molecular and optical eigenfunctions. Direct measurement of the frequency and amplitude of the central fringe as a function of intensity in the cavity in U gives the required data, as displayed in Figure 8. The plot of fringe amplitude against intensity then locates the $\pi/2$ point which agrees, well within its error, with the value calculated for the operational conditions. The shift in frequency from zero power to $\pi/2$ is $+0.75 \pm 0.5$ Hz and from 0 to π the shift is $+13.5 \pm 2$ Hz where the accuracy is limited by the location of the $\pi/2$ point. This problem is less acute at the $\pi/2$ point where the curve is almost flat, having a slope of $+0.06$ Hz/mW. Indeed this is particularly significant for a potential standard. The current measurements are smaller than those earlier reported [9] for a He-seeded beam, which is undoubtedly due to the resolution. Most importantly the saturation power varies with hyperfine component. Thus, when the light power is increased in a situation of incomplete resolution the centre of gravity of the fringe pattern will shift. A simple calculation predicts a global shift of $+5$ Hz for the fringes [16]. However this must be modified to apply directly to individual hyperfine components and we are continuing to work on this question.

In terms of absolute fringe frequency, the second order Doppler shift also plays a role. The molecular velocity is estimated as 400m/s from the fringe periodicity and the interzone distance. The shift is calculated as 25 Hz and is quadratic in velocity. Thus to obtain the correction to the laser frequency at a precision of 1 Hz the interzone distance must be measured to 4 cm, which is easily done.

VI. CONCLUSION

The 2-photon Ramsey fringe experiment on SF₆ currently presents the best frequency standard directly available at 10 μm .

Under conditions which are easily controlled and to which the experiment is unlikely to be very sensitive the frequency of the central fringe reproduces to better than ± 2 Hz. The corresponding hyperfine spectrum over 50 kHz is known to a similar accuracy. This situation results from two significant advances: the use of a 1 m zone separation giving a basic fringe periodicity of 200 Hz, and the implementation of a fs comb locking and measuring system related directly to the H maser standard. It is likely that this performance will be improved in the near future by upgrading the RF components in the measuring system, as these represent a current limitation, and by working carefully over a series of systematic effects.

With the resolution and reproducibility now obtained very sensitive tests of fundamental physics are a realistic goal. Parity violating frequency differences in the spectra of chiral molecules, recently calculated to be 50 mHz for CHFBrI [17], are certainly in sight. Recall, from Figure 4, that currently a 500 mHz difference can be established in an experiment requiring only 7 minutes. Time variation of fundamental constants presents a second intriguing possibility. The current Ramsey fringe experiment measures the ratio of a vibrational frequency in the SF₆ molecule to a hyperfine frequency in an atom, since the Cs atomic fountain gives the ultimate reference. This ratio, necessarily dimensionless, is mainly sensitive to the fine structure constant and to the ratio of proton to electron masses. Limits can already be placed on the time variations, even from the limited data presented here [18], and the experiment will certainly be refined in the near future.

REFERENCES

- [1] O. Acef, "Metrological properties of CO₂/OsO₄ optical frequency standard," *Opt. Comm.*, vol. 134, pp. 479-486, 1997.
- [2] V. Bernard *et al.*, "CO₂ laser stabilization to 0.1-Hz level using external electrooptic modulation," *IEEE J. of Quant. Electron.*, vol. QE-33, pp. 1282-1287, 1997.
- [3] R. J. Butcher, Ch. Chardonnet, and Ch.J. Bordé, "Hyperfine lifting of parity degeneracy and the question of inversion in a rigid molecule," *Phys. Rev. Lett.*, vol. 70, pp. 2698-2701, 1993.
- [4] Ch. Chardonnet, F. Guernet, G. Charton, and Ch. J. Bordé, "Ultrahigh-resolution saturation spectroscopy using slow molecules in an external cell," *Appl. Phys. B*, vol. B59, pp. 333-343, 1994.
- [5] J. Reichert *et al.*, "Phase Coherent Vacuum-Ultraviolet to Radio Frequency Comparison with a Mode-Locked Laser," *Phys. Rev. Lett.*, vol. 84, pp. 3232-3235, 2000.
- [6] D.J. Jones *et al.*, "Carrier-envelope Phase Control of Femtosecond Mode-Locked Lasers and Direct Optical Frequency Synthesis," *Science*, vol. 288, pp. 635-639, 2000.
- [7] L. F. Constantin *et al.*, "2.3 kHz two-photon Ramsey fringes at 30 THz," *Phys. Rev. A*, vol. 60, pp. 753-756, 1999.
- [8] A. Amy-Klein *et al.*, "High-resolution spectroscopy with a molecular beam at 10.6 μm ," *Phys. Rev. A*, vol. 63, pp. 0134041-0134048, 2000.
- [9] A. Shelkovich *et al.*, "500-Hz two-photon Ramsey fringes with a SF₆ beam : towards a new frequency standard in the 30-THz spectral region," *Appl. Phys. B*, vol. 73, pp. 93-98, 2001.
- [10] C. Grain *et al.*, "High-sensitivity detection of two-photon Ramsey fringes at 30 THz by frequency-comb assisted stimulated emission," *IEEE J. of Quant. Electron.*, vol. 38, pp. 1406-1411, 2002.
- [11] Ch.J. Bordé, "Sur les franges de Ramsey en spectroscopie sans élargissement Doppler," *C. R. Séances Acad. Sc. Paris*, vol. B 284, pp. 101-104, 1977.
- [12] S. T. Cundiff, J. Ye, and J. L. Hall, "Optical frequency synthesis based on mode-locked lasers," *Review of Scientific Instruments*, vol. 72, pp. 3749-3771, 2001.
- [13] A. Amy-Klein *et al.*, "Absolute frequency measurement in the 28 THz spectral region with a femtosecond laser comb and a long-distance optical link to a primary standard," *Appl. Phys. B*, vol. 78, pp. 25-30, 2004.
- [14] G. Santarelli *et al.*, "Quantum Projection Noise in an Atomic Fountain : a High Stability Cesium Frequency Standard," *Phys. Rev. Lett.*, vol. 82, pp. 4619-4622, 1999.
- [15] P. Lesage, "Characterization of Frequency stability : Bias due to the Juxtaposition of Time-Interval Measurement", *IEEE Trans. Instrum. Meas.*, vol. 32, pp. 204-207, 1983.
- [16] A. Amy-Klein *et al.*, "Slow molecule detection or Ramsey fringes in two-photon spectroscopy : which is better for high resolution spectroscopy and metrology?," *Opt. Expr.*, vol. 4, pp. 67-76, 1999.
- [17] P. Schwerdtfeger, J.K. Laerdahl, and Ch. Chardonnet, "Calculation of parity-violation effects for the C-F stretching mode of chiral methyl fluorides," *Phys. Rev. A*, vol. 65, pp. 0425081-0425087., 2002.
- [18] C. Chardonnet *et al.*, "Absolute frequency measurements of molecular transitions at ultra-high precision : towards new tests of time variation of the fundamental constants," *ICOLS03, Palm Cove, Australia*, 2003.

Figure captions

Figure 1: Block diagram of the two photon Ramsey fringe experiment referenced to a Hydrogen Maser/Cs fountain standard via a fs comb. Synthesizer 1 is used to tune CO₂ laser 2 through the Ramsey fringes. Synthesizer 2, at approximately 1 GHz, is used to mix the fs repetition frequency down, the counter operates in the 0-100 kHz range. Two phase-lock loops (PLL) are always in use while the third (PLL_a) is used only when the fringes are scanned. All synthesizers and the counter are referenced to the Hydrogen Maser located at BNM-SYRTE via an optical fibre link at 1.55 μm .

Figure 2 Fringes at 200 Hz, obtained using a 1m interzone separation. Experimental conditions: pure SF₆, input pressure 5×10^5 Pa, 12 mW inside U cavity FM modulation at 115 Hz index 0.43, 75 μW inside the detection cavity, time constant for detection 0.1s. Average of 5 up-down sweeps, 200 points, averaging 1s per point. Signal-to-noise ratio 20.

Figure 3: Simplified schematic of lasers and frequencies involved in locking of the fs system to a CO₂ laser frequency. The diode lasers at 852 and 788 nm are phase locked to two modes of the femtosecond comb while their frequency difference is locked to the CO₂ frequency.

Figure 4: Relative Allan deviation obtained by logging the counter frequency while the system was locked to the central fringe in SF₆, as calculated from a series of 1 s gate measurement.

Figure 5: Resolution of the hyperfine structure of the P(4) E⁰ two-photon line in the 2v₃ band of SF₆, obtained using a 1m interzone separation. Twelve contiguous sections, each of 4 kHz, give a total scan of 48 kHz. The scale is given in kHz relative to the central fringe. Experimental conditions: pure SF₆, input pressure 5×10^5 Pa, 12 mW inside U cavity, FM modulation at 115 Hz index 0.43, 75 μW inside the detection cavity, time constant for detection 0.1s. Ten sweeps, five up and five down, were normally recorded and 1000 data acquired, thus giving an averaging time of 1 s per point.

Figure 6: Enlarged view of the central 4 kHz of the spectrum. Conditions as in Figure 5. The spectrum is fitted with four hyperfine components, using a single periodicity, velocity dispersion, and background 2-photon signal.

Figure 7: Histograms of frequency measurements of the central fringe as obtained by recording the fringe. a) Absolute frequencies, 24 groups of measurements, $\sigma=1.4$ Hz. b) Relative to mean for each group, 80 measurements, $\sigma=0.6$ Hz. In each case the solid line shows the associated Normal distribution.

Figure 8: The light shift; amplitude and shift of central fringe as a function of laser power in the U Cavity. (a) Survey of all data on shifts with approximate error bars, and intensities from four separate experiments. There is no normalisation of intensities between experiments. (b) Polynomial fit at laser powers up to a π pulse, yielding a slope of 0.06 Hz/mW at the $\pi/2$ point, 12 mW.

Figure 1

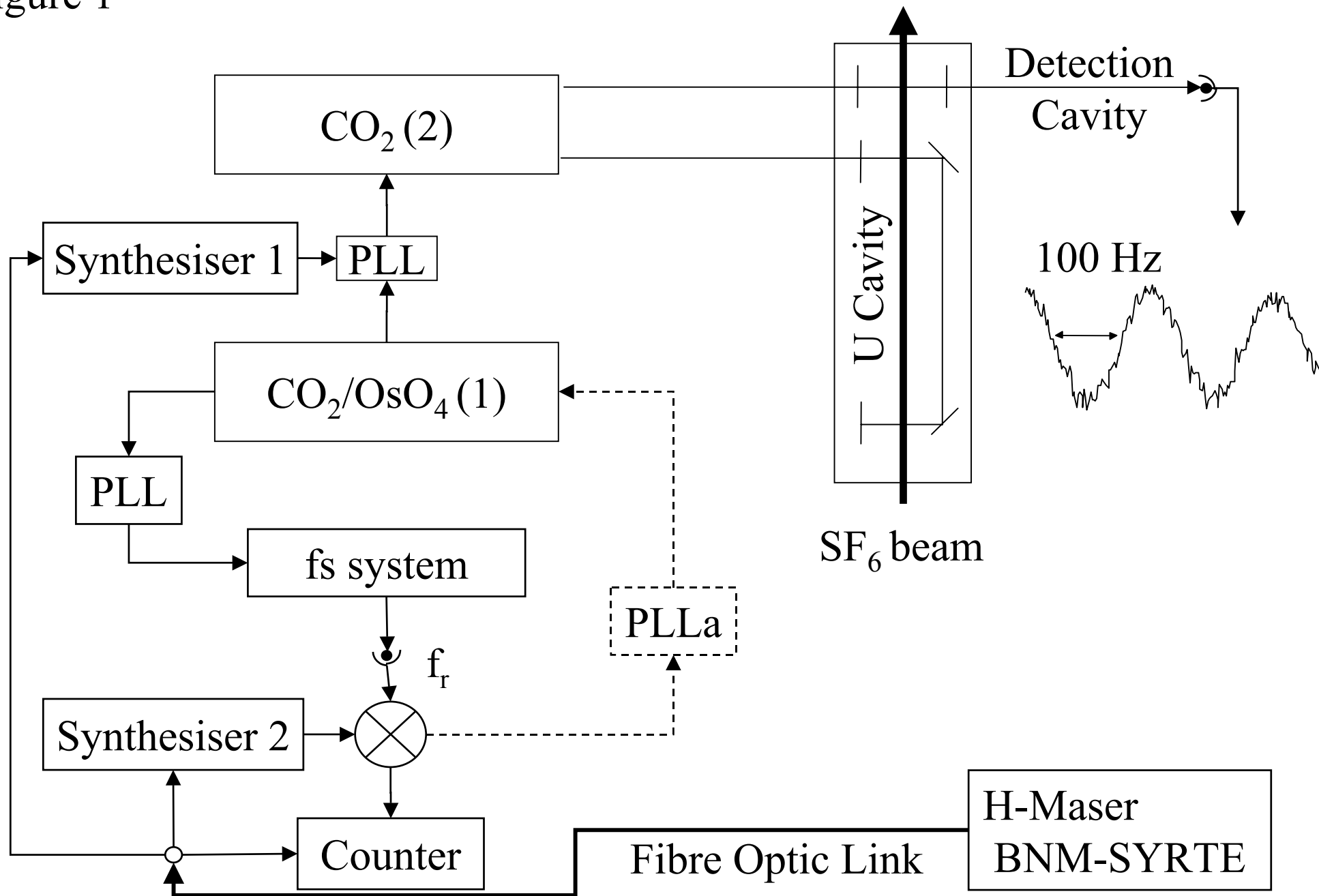

Figure 2

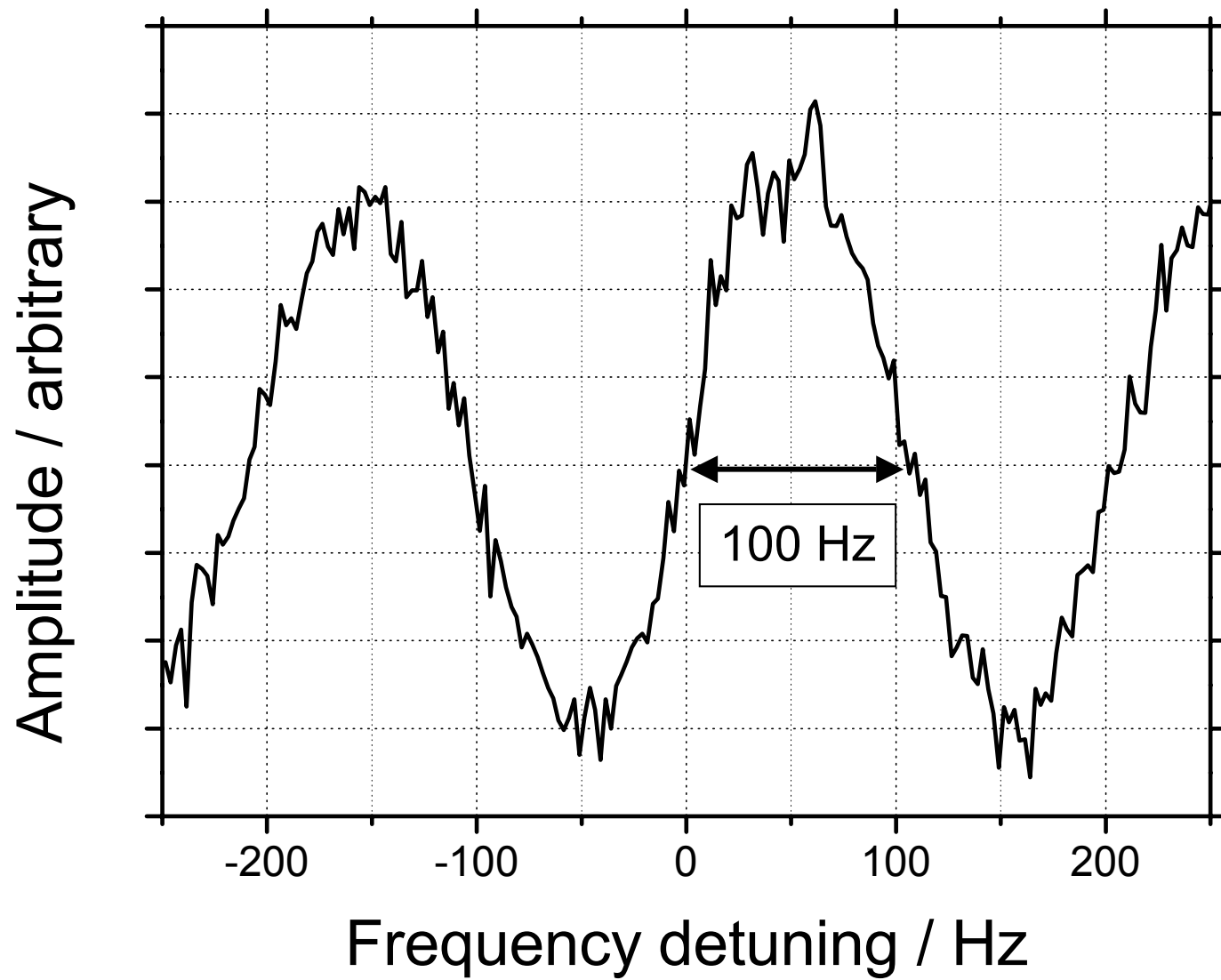

Figure 3

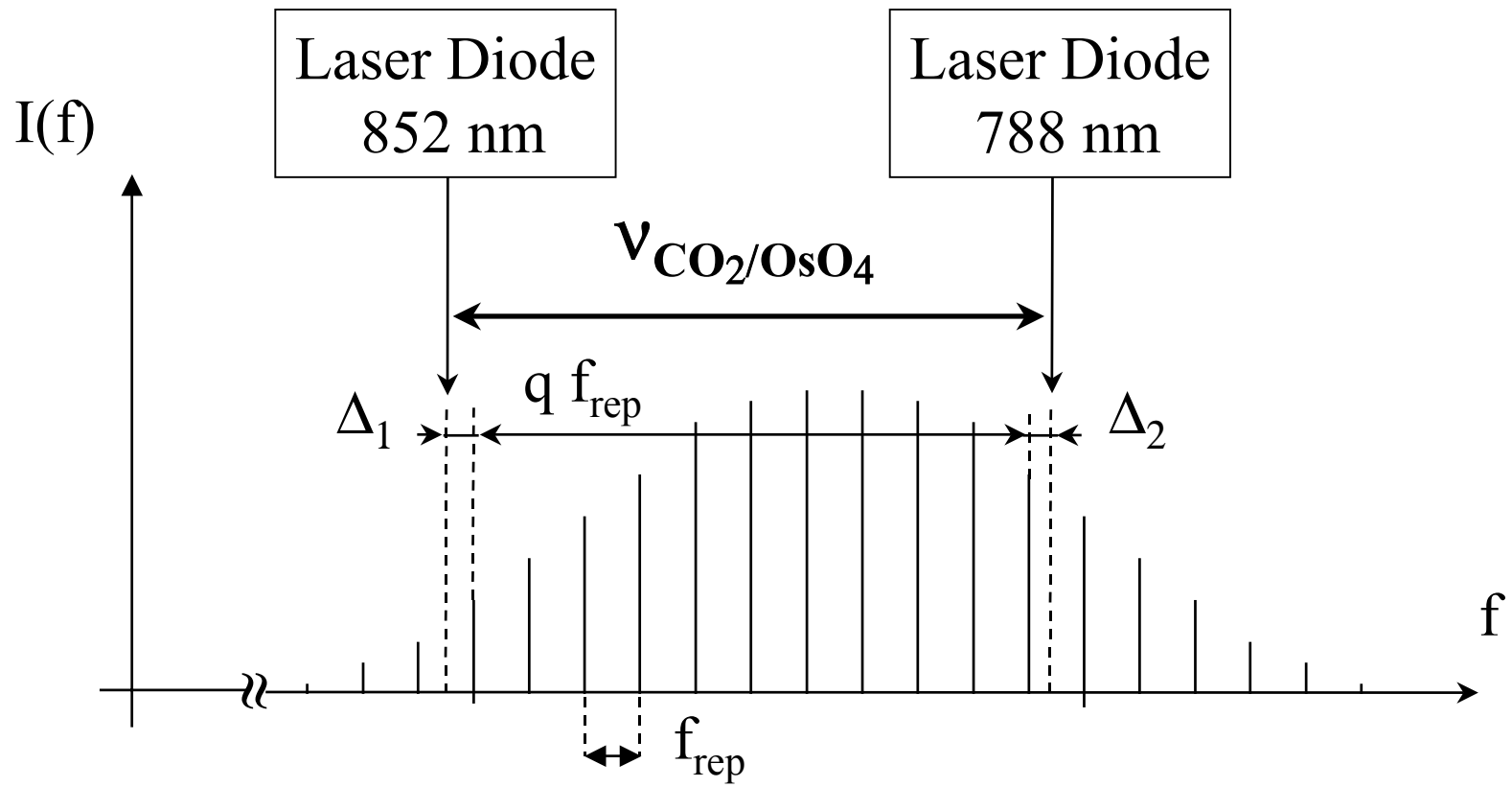

Figure 4

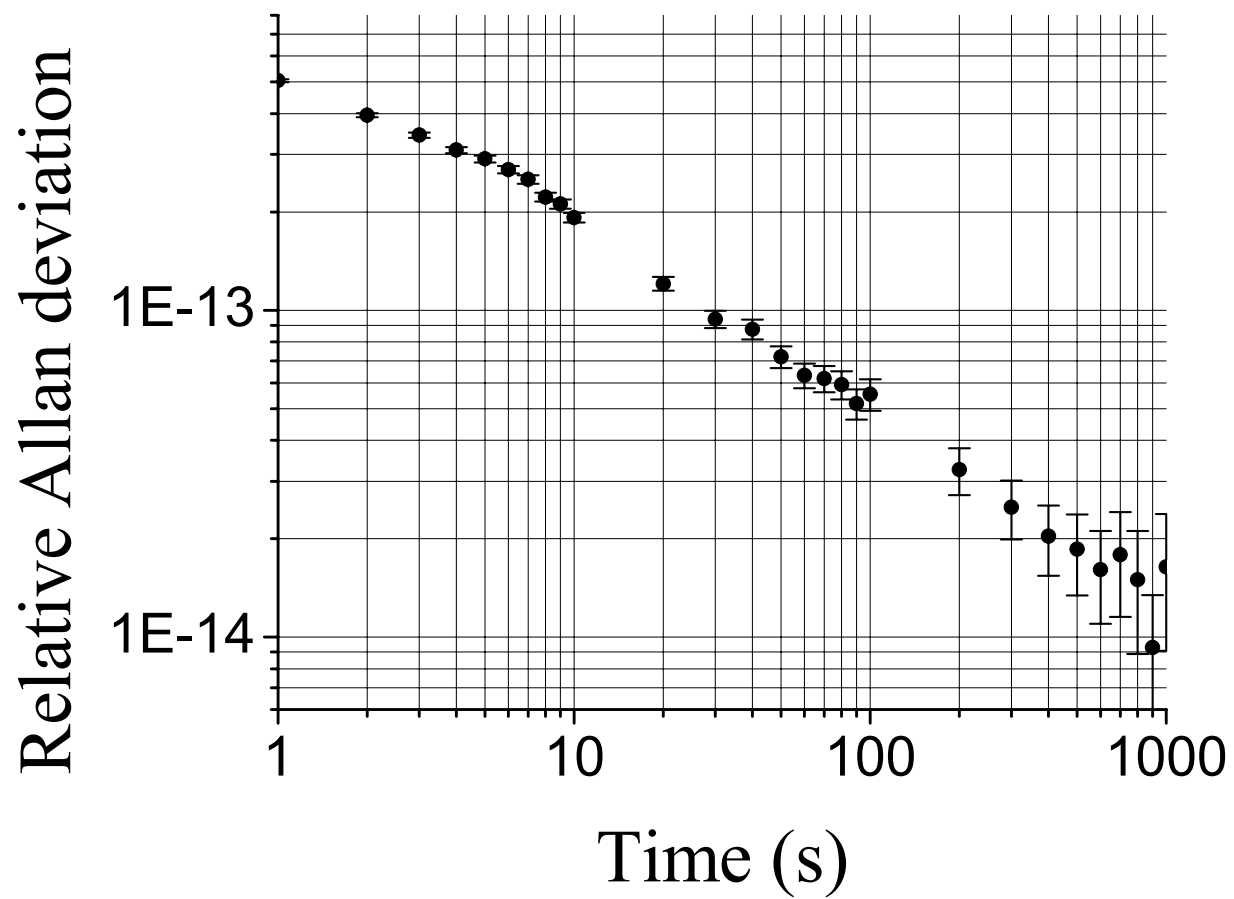

Figure 5

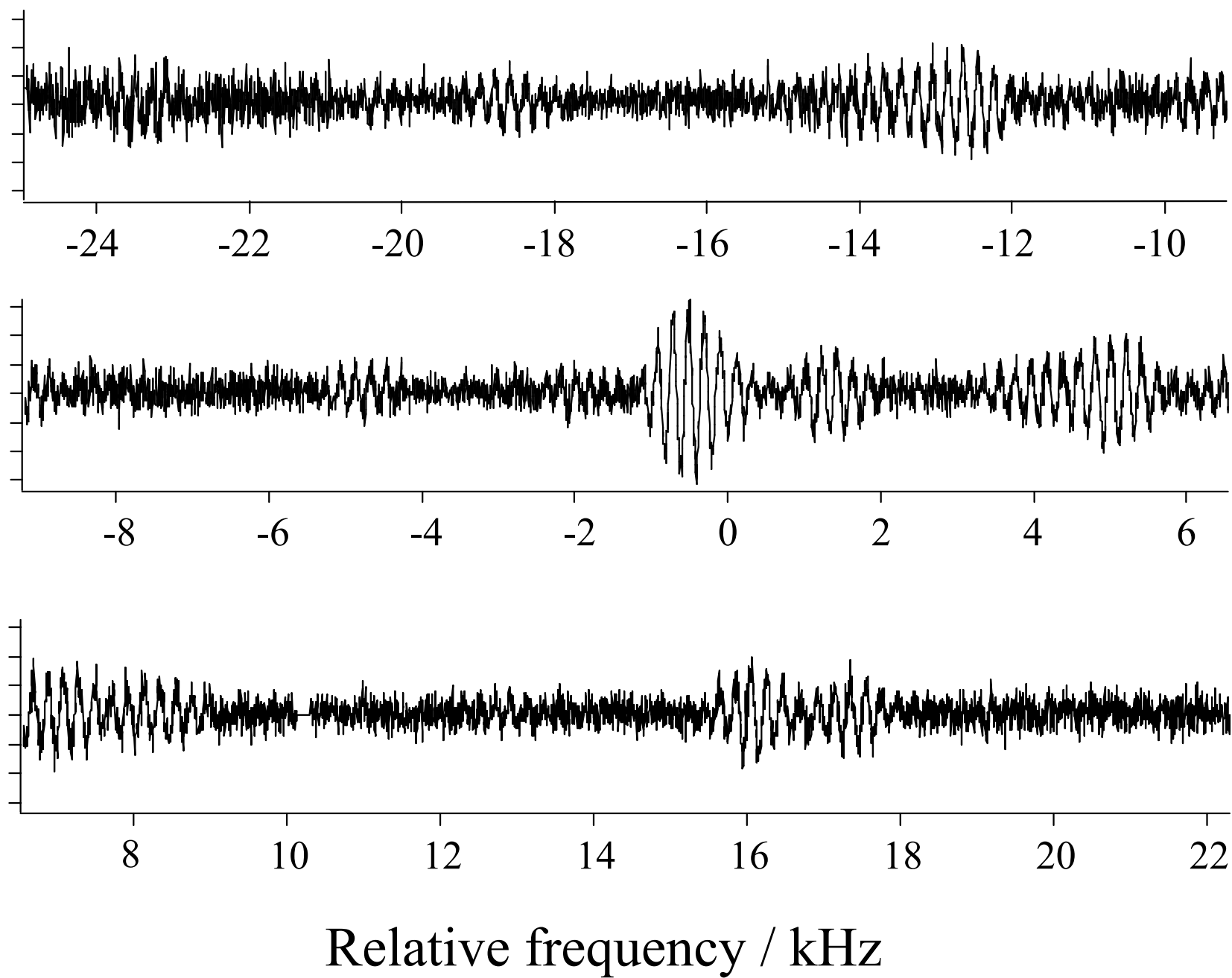

Figure 6

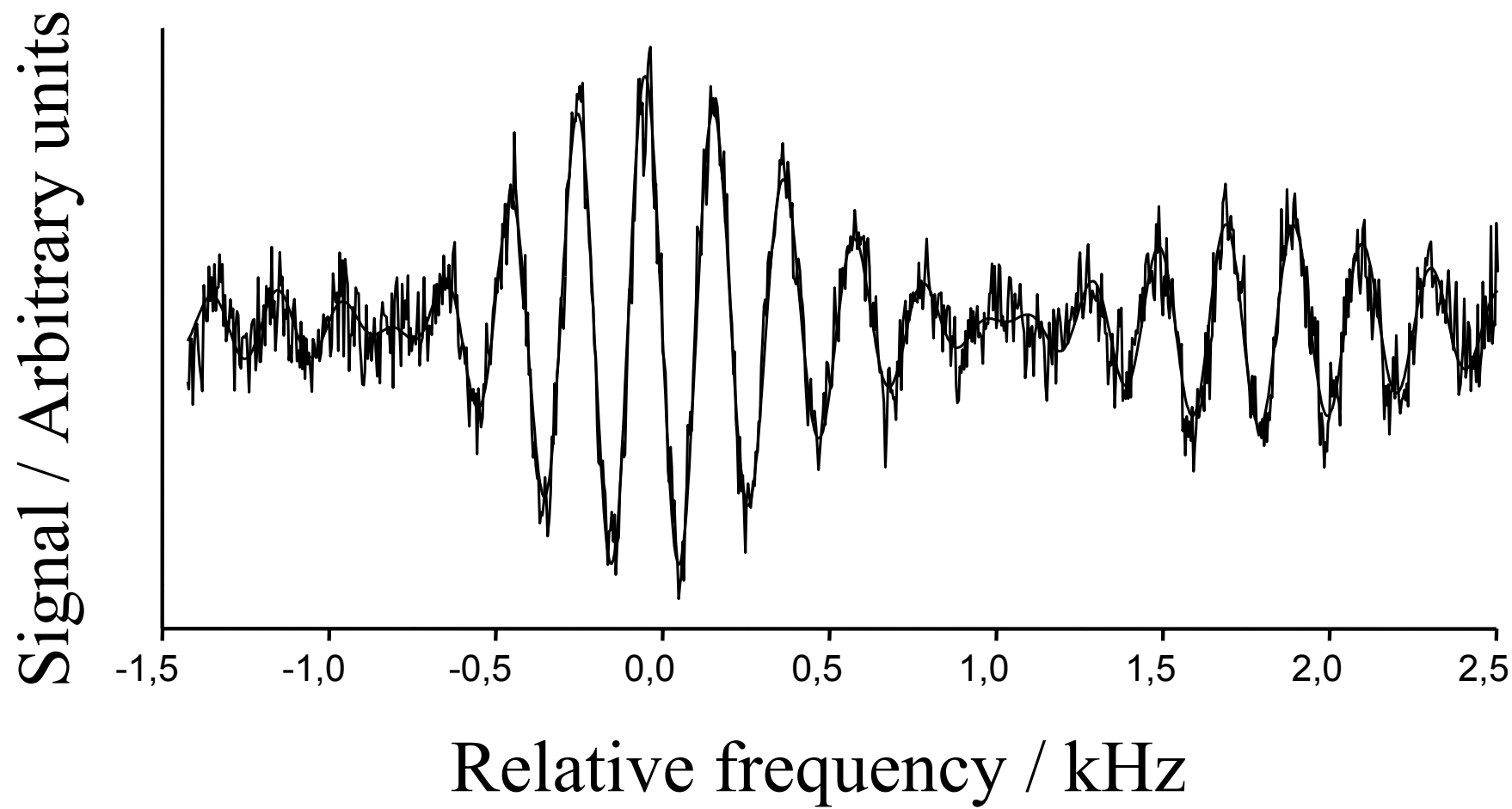
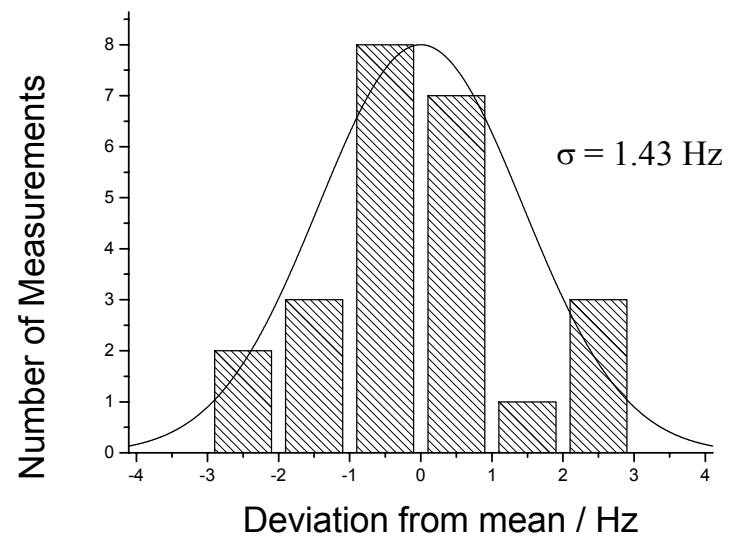

Figure 7

(a)



(b)

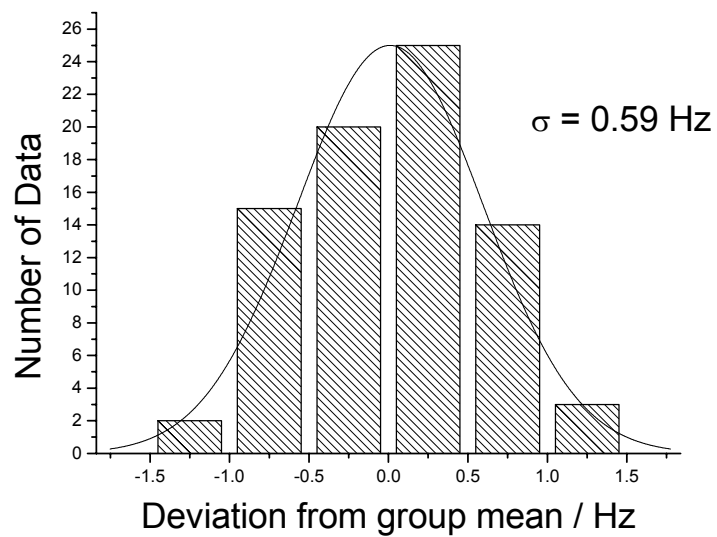
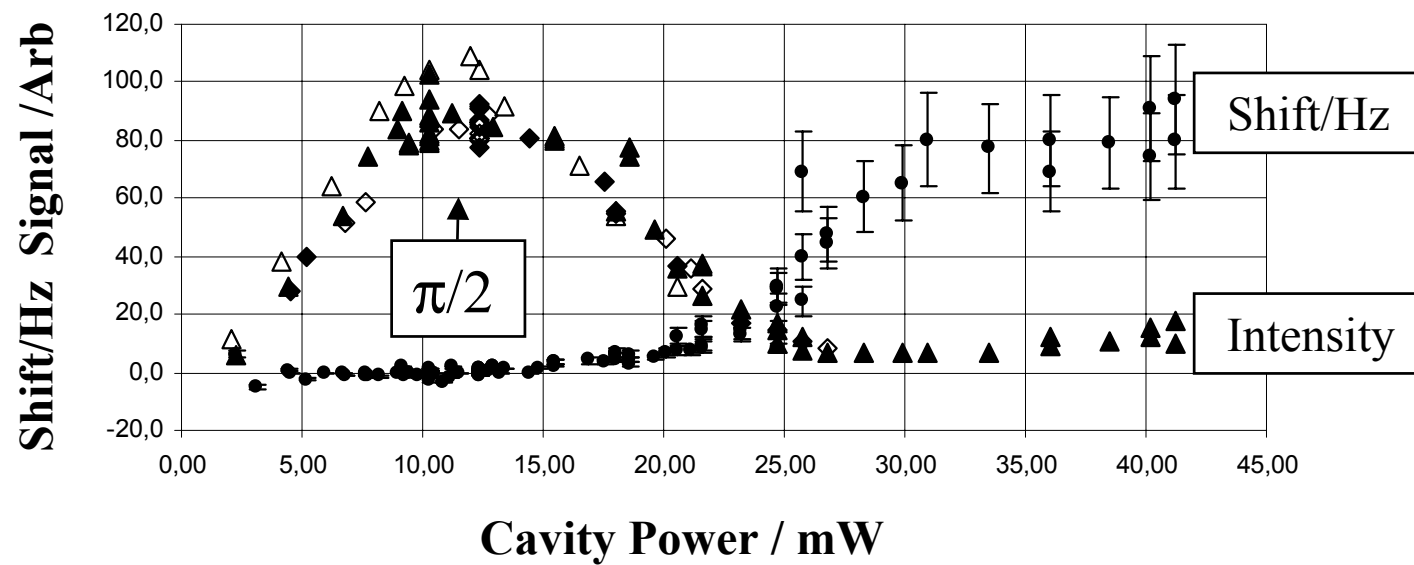

Figure 8

(a)



(b)

