

REAL QUADRICS IN \mathbb{C}^n , COMPLEX MANIFOLDS AND CONVEX POLYTOPES

FRÉDÉRIC BOSIO, LAURENT MEERSSEMAN

19 March 2004

dedicated to Alberto Verjovsky on his 60th birthday

ABSTRACT. In this paper, we investigate the topology of a class of non-Kähler compact complex manifolds generalizing that of Hopf and Calabi-Eckmann manifolds. These manifolds are diffeomorphic to special systems of real quadrics in \mathbb{C}^n which are invariant with respect to the natural action of the real torus $(\mathbb{S}^1)^n$ onto \mathbb{C}^n . The quotient space is a simple convex polytope. The problem reduces thus to the study of the topology of certain real algebraic sets and can be handled using combinatorial results on convex polytopes. We prove that the homology groups of these compact complex manifolds can have arbitrary amount of torsion so that their topology is extremely rich. We also resolve an associated wall-crossing problem by introducing holomorphic equivariant elementary surgeries related to some transformations of the simple convex polytope. Finally, as a nice consequence, we obtain that affine non Kähler compact complex manifolds can have arbitrary amount of torsion in their homology groups, contrasting with the Kähler situation.

Introduction

This work explores the relationships existing between three classes of objects, coming from different domains of mathematics, namely:

(i) *Real algebraic geometry*: the objects here are what we call *links*, that is transverse intersections in \mathbb{C}^n of real quadrics of the form

$$\sum_{i=1}^n a_i |z_i|^2 = 0 \quad a_i \in \mathbb{R}$$

with the unit euclidean sphere of \mathbb{C}^n .

(ii) *Convex geometry*: the class of simple convex polytopes.

(iii) *Complex geometry*: the class of non-Kähler compact complex manifolds of [Me1].

1991 *Mathematics Subject Classification*. 32Q55, 32M17, 52B05, 52C35.

Key words and phrases. topology of non-Kähler compact complex manifolds, affine complex manifolds, combinatorics of convex polytopes, real quadrics, equivariant surgery, subspace arrangements.

The second author would like to thank Santiago López de Medrano for many fruitful discussions. Thanks also to Alberto Verjovsky for giving the reference [Al].

Typeset by $\mathcal{A}\mathcal{M}\mathcal{S}$ - $\mathcal{T}\mathcal{E}\mathcal{X}$

The natural connection between these classes goes as follows. First, a link is invariant by the standard action of the real torus $(\mathbb{S}^1)^n$ onto \mathbb{C}^n and the quotient space is easily seen to identify with a simple convex polytope (Lemma 0.11). Secondly, as a direct consequence of the construction of [Me1], each link (after taking the product by a circle in the odd-dimensional case) can be endowed with a complex structure of a manifold of [Me1] (Theorem 12.2).

The aim of the paper is to describe the topology of the links and to apply the results to address the following question

Question. *How complicated can be the topology of the compact complex manifolds of [Me1]?*

This program is achieved by making a reduction to combinatorics of simple convex polytopes: a simple convex polytope encodes completely the topology of the associated link.

As shown by the question, the main motivation comes from complex geometry. Let us explain a little more why we find important to know the topology of the manifolds of [Me1].

Complex geometry is concerned with the study of (compact) complex manifolds. Nevertheless, no general theory exists and only special classes of complex manifolds as projective or Kähler manifolds or complex manifolds which are at least bimeromorphic to projective or Kähler ones are well understood. Moreover, except for the case of surfaces, there are few explicit examples having none of these properties; explicit meaning that it is possible to work with and to compute things on it. Indeed, the two classical families are the Hopf manifolds (diffeomorphic to $\mathbb{S}^1 \times \mathbb{S}^{2n-1}$, see [Ho]) and the Calabi-Eckmann manifolds (diffeomorphic to $\mathbb{S}^{2p-1} \times \mathbb{S}^{2q-1}$, see [C-E]).

In [LdM-Ve], [Me1] and [Bo], a new class of examples was provided. In particular, the class of [Me1] is explicit in the previous sense; the main complex geometrical properties (algebraic dimension, generic holomorphic submanifolds, local deformation space, ...) of these objects are established in [Me1].

Besides, it is proved in [Me2] that they are small deformations of holomorphic principal bundles over projective toric varieties with fiber a compact complex torus. In this sense, they constitute a natural generalization of Hopf and Calabi-Eckmann manifolds, which can be deformed into compact complex manifolds fibering in elliptic curves over the complex projective space \mathbb{P}^{n-1} (Hopf case) or over the product of projective spaces $\mathbb{P}^{p-1} \times \mathbb{P}^{q-1}$ (Calabi-Eckmann case). One of the main interest of these manifolds however is that they have a richer topology, since it is also proved in [Me1] that complex structures on certain connected sums of products of spheres can be obtained by this process.

Nevertheless, these examples of connected sums constitute very particular cases of the construction and the problem of describing the topology in the other cases was left wide open in [Me1]. Of course, due to the lack of examples of non Kähler and non Moishezon compact complex manifolds, the more intricate this topology is, the more interesting is the class of [Me1]. This is the starting point and motivation for this work and leads to the question stated above.

In [Me1], it was conjectured that they are all diffeomorphic to products of connected sums of spheres products and odd-dimensional spheres.

On the other hand, it follows from the construction that a manifold N of [Me1] is entirely characterized by a set Λ of m vectors of \mathbb{C}^n (with $n > 2m$). Moreover, a

homotopy of Λ in \mathbb{C}^n gives rise to a deformation of N as soon as an open condition is fulfilled at each step of the homotopy. If this condition is broken during the homotopy, the diffeomorphism type of the new complex manifold N' is different from that of N . In other words, there is a natural wall-crossing problem, and this leads to:

Problem. *Describe the topological and holomorphic changes occurring after a wall-crossing.*

This wall-crossing problem is linked with the previous question, since knowing how the topology changes after a wall-crossing, one can expect describe the most complicated examples. But it has also a holomorphic part, since the initial and final manifolds are complex.

In this article, we address these questions and give a description as complete as we can of the topology of these compact complex manifolds:

- Concerning the question above, the very surprising answer is that the topology of the complex manifolds of [Me1] is much more complicated than expected. Indeed, their homology groups can have arbitrary amounts of torsion (Theorem 14.1). Counterexamples are given in Section 11, as well as a constructive way of obtaining these arbitrary amounts of torsion.
- Concerning the wall-crossing problem, we show that crossing a wall means performing a complex surgery and describe precisely these surgeries from the topological and the holomorphic point of view (Theorems 5.4 and 13.3).

As an easy but nice consequence, we obtain that affine compact complex manifolds (that is compact complex manifolds with an affine atlas) can have arbitrary amount of torsion. It is thus not possible to classify, up to diffeomorphism, affine compact complex manifolds or manifolds having a holomorphic affine connection in high dimensions (≥ 3).

It is interesting to compare this result with the Kähler case: it is known that affine Kähler manifolds are covered by complex tori (see [K-W]), so the difference here is striking. Notice also that a statement similar to Theorem 14.1 is unknown for Kähler manifolds.

The paper is organized as follows. In Section 0, we collect the basic facts about the links. In particular, we introduce the simple convex polytope associated to a link as well as a subspace arrangement whose complement has the same homotopy type as the associated link. We also recall the previously known cases studied in [LdM1] and [LdM2].

In part I, we prove that the classes of links up to equivariant diffeomorphism (equivariant with respect to the action of the real torus) and up to product by circles are in 1 : 1 correspondence with the combinatorial classes of simple convex polytopes (Rigidity Theorem 4.1). This is the first main result of this part. It allows us to translate topological problems about the links entirely in the world of combinatorics of simple convex polytopes. In particular, we recall the notion of flips of simple polytopes of [McM] and [Ti] in Section 2 and prove some auxiliary results. We define in Section 3 a set of equivariant elementary surgeries on the links and prove in Section 4 (Theorem 4.7) that performing a flip on a simple convex polytope means performing an equivariant surgery on the associated link. Finally, we introduce in Section 5 the notion of wall-crossing of links and prove the second main Theorem of this part (Wall-crossing Theorem 5.4): crossing a wall for a link is equivalent to performing a flip for the associated simple convex polytope and

therefore the wall-crossing can be described in terms of elementary surgeries. As a consequence, we generalize a result of Mac Gavran (see [McG]) and describe explicitly the diffeomorphism type of certain families of links in Section 6.

In part II, we give a formula for computing the cohomology ring of a link in terms of subsets of the associated simple convex polytope. To do this, we apply the Goresky-MacPherson formula [G-McP] and the cohomology product formula of De Longueville [DL] on the subspace arrangement mentioned earlier. We rewrite them in terms of the simple polytope. The existence of such a formula is rather mysterious. Indeed it is somewhat miraculous that Goresky-MacPherson and De Longueville formulas can be rewritten on the convex polytope and that they become so easy in this new form. For example, it is rather difficult to check with the Goresky-MacPherson formula that the homology groups of a link satisfy Poincaré duality; with this new formula, Poincaré duality is given by Alexander duality on the boundary of the simple convex polytope (seen as a sphere). The proof of this formula is long and technically difficult. It is a matter of taking explicit Alexander duals of cycles in simplicial spheres. The formula is stated up to sign (for the cohomology product) in Section 7 as Cohomology Theorem 7.6. and is proved in Sections 7 and Sections 9 after some preliminary material about orientation and explicit Alexander duals in Section 8 and 9. The sign is made precise in Section 10. Finally, applications and examples are given in Section 11, and it is proved that the homology groups of a link can have arbitrary torsion (Torsion Theorem 11.11).

In part III, we apply the previous results to the family of compact complex manifolds of [Me1]. In Section 12, we recall very briefly their construction and prove that an even-dimensional link admits such a complex structure as well as the product of an odd-dimensional link by a circle. We resolve the holomorphic wall-crossing problem in Section 13 (Theorem 13.3). Finally, in Section 14, we obtain as an easy consequence of Theorem 11.11 that the homology groups of a compact complex manifold of [Me1] can have arbitrary amount of torsion, and as easy consequence of the construction that such a statement is true for affine compact complex manifolds.

Although the main motivation comes from complex geometry, part I (especially Section 6) should also be of interest for readers working on smooth actions of the torus on manifolds. It can be seen as a continuation of [LdM1], [LdM2] and [McG]. On the other hand, the cohomology formula of Part II has its own interest as a nice simplification of the Goresky-Mac Pherson and De Longueville formulas for a special class of subspace arrangements.

Notice that the smooth manifolds that we call links appear (but with a different definition, in particular not as intersection of quadrics) in the study of toric or quasitoric manifolds (see [D-J] and [B-P]). In a sense, some results of this paper are complementary to that of [D-J] and [B-P].

0. Preliminaries

In this Section, we give the basic definitions, notations and lemmas. Some of the results are stated and sometimes proved in [Me1] or [Me2], but in different versions; in this case we give the original reference, but at the same time, we give at least some indication about the proof to be self-contained.

In this paper, we denote by \mathbb{S}^{2n-1} the unit euclidean sphere of \mathbb{C}^n , and by \mathbb{D}^{2n} (respectively $\overline{\mathbb{D}^{2n}}$) the unit euclidean open (respectively closed) ball of \mathbb{C}^n .

Definition 0.1. A *special real quadric* in \mathbb{C}^n is a set of points $z \in \mathbb{C}^n$ satisfying :

$$\sum_{i=1}^n a_i |z_i|^2 = 0$$

for some fixed n -uple (a_1, \dots, a_n) in \mathbb{R}^n .

We are interested in the topology of the intersection of a finite (but arbitrary) number of special real quadrics in \mathbb{C}^n with the euclidean unit sphere. We call such an intersection the *link* of the system of special real quadrics.

Let $A \in M_{np}(\mathbb{R})$, that is A is a real matrix with n columns and p rows. We write A as (A_1, \dots, A_n) . To A , we may associate p special real quadrics in \mathbb{C}^n and a link, which we denote by X_A . The corresponding system of equations, that is :

$$\begin{cases} \sum_{i=1}^n A_i \cdot |z_i|^2 = 0 \\ \sum_{i=1}^n |z_i|^2 = 1 \end{cases}$$

will be denoted by (S_A) .

Notice that we include the special case $p = 0$. In this situation, $A = 0$ is a matrix of $M_{n0}(\mathbb{R})$ and X_A is \mathbb{S}^{2n-1} .

Definition 0.2. Let $A \in M_{np}(\mathbb{R})$. We say that A is *admissible* if it gives rise to a link X_A whose system (S_A) is non degenerate at every point of X_A . We denote by \mathcal{A} the set of admissible matrices.

In this paper, we restrict ourselves to the case where A is admissible. A link is thus a smooth compact manifold of dimension $2n - p - 1$ without boundary. Moreover it has trivial normal bundle in \mathbb{C}^n , so is orientable.

We denote by $\mathcal{H}(A)$ the convex hull of the vectors A_1, \dots, A_n in \mathbb{R}^p .

Lemma 0.3 (cf [Me2], Lemma 1.1). *Let $A \in M_{np}(\mathbb{R})$. Then A is admissible if and only if it satisfies :*

- (i) *The Siegel condition : $0 \in \mathcal{H}(A)$.*
- (ii) *The weak hyperbolicity condition : $0 \in \mathcal{H}(A_i \mid i \in I) \Rightarrow \text{cardinal}(I) > p$.*

Proof.

Clearly X_A is non vacuous if and only if the Siegel condition is satisfied.

Let $z \in X_A$ and let

$$(1) \quad I_z = \{1 \leq i \leq n \mid z_i \neq 0\} = \{i_1, \dots, i_q\} .$$

The system (S_A) is non degenerate at z if and only if the matrix :

$$\tilde{A}_z = \begin{pmatrix} A_{i_1} & \dots & A_{i_q} \\ 1 & \dots & 1 \end{pmatrix}$$

has maximal rank, i.e. rank $p + 1$.

Assume the weak hyperbolicity condition. As $z \in X_A$, we have $0 \in \mathcal{H}((A_i)_{i \in I_z})$. By Carathéodory's Theorem ([Gr], p.15), there exists a subset $J = \{j_1, \dots, j_{p+1}\} \subset$

I_z such that 0 belongs to $\mathcal{H}((A_i)_{i \in J})$. Moreover, $(A_{j_1}, \dots, A_{j_{p+1}})$ has rank p , otherwise, still by Carathéodory's Theorem, 0 would be in the convex hull of p of these vectors, contradicting the weak hyperbolicity condition.

As a consequence of these two facts, the vector space of linear relations between $(A_{j_1}, \dots, A_{j_{p+1}})$ has dimension one and is generated by a solution with all coefficients nonnegative. Assume that \tilde{A}_z has rank strictly less than $p+1$. Then, there is a non-trivial linear relation between $(A_{j_1}, \dots, A_{j_{p+1}})$ with the additional property that the sum of the coefficients of this relation is zero. Contradiction.

Conversely, assume that the weak hyperbolicity condition is not satisfied. For example, assume that 0 belongs to $\mathcal{H}(A_1, \dots, A_p)$ and let $r \in (\mathbb{R}^+)^p$ such that :

$$\sum_{i=1}^p r_i \cdot A_i = 0, \quad \sum_{i=1}^p r_i = 1 .$$

Then $z = (\sqrt{r_1}, \dots, \sqrt{r_p}, 0, \dots, 0)$ belongs to X_A and rank \tilde{A}_z is at most p so A is not admissible. \square

Note that the intersection $\mathcal{A} \cap M_{np}(\mathbb{R})$ is open in $M_{np}(\mathbb{R})$.

Let us describe some examples.

Example 0.4. Let $p = 1$. Then the A_i are real numbers. The weak hyperbolicity condition implies that none of the A_i is zero. Let us say that a of the A_i are strictly positive whereas $b = n - a$ of the A_i are strictly negative. The Siegel condition implies that a and b are strictly positive. There is just one special real quadric, which is the equation of a cone over a product of spheres $\mathbb{S}^{2a-1} \times \mathbb{S}^{2b-1}$. As we take the intersection of this quadric with the unit sphere, we finally obtain that X_A is diffeomorphic to $\mathbb{S}^{2a-1} \times \mathbb{S}^{2b-1}$.

Example 0.5. Let $p = 2$. Then the A_i are points in the plane containing 0 in their convex hull (Siegel condition). The weak hyperbolicity condition implies that 0 is not on a segment joining two of the A_i . Here are two examples of admissible configurations.

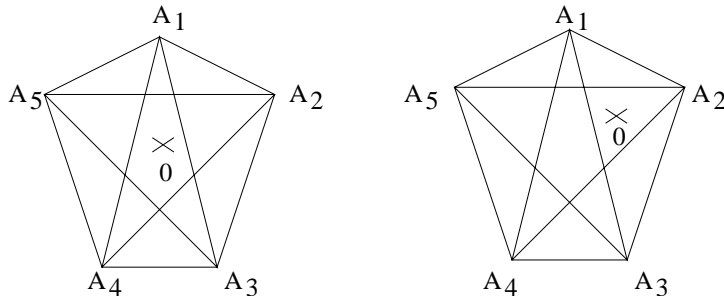

Assume that we perform a smooth homotopy $(A^t)_{0 \leq t \leq 1}$ between $A^0 = A$ and A^1 in \mathbb{R}^2 such that A^t still satisfies the Siegel and the weak hyperbolicity conditions for any t . Then the union of the X_{A^t} (seen as a smooth submanifold of $\mathbb{C}^n \times \mathbb{R}$) admits a submersion onto $[0, 1]$ with compact fibers. Therefore, by Ehresmann's Lemma, this submersion is a locally trivial fiber bundle and X_{A^1} is diffeomorphic to $X_{A^0} = X_A$. Using this trick, it can be proven that X_A is diffeomorphic to $X_{A'}$, where A' is a configuration of an odd number $k = 2l + 1$ of distinct points

with weights n_1, \dots, n_k (see [LdM2]). The result of such an homotopy on the two configurations of the previous picture is represented below. The arrows indicate the homotopy and the numbers appearing on the circles are the weights of the final configuration.

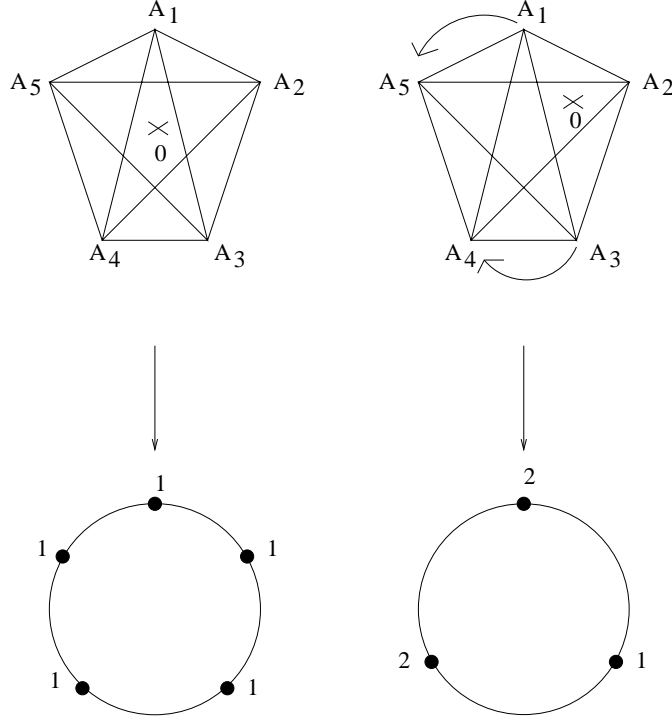

These weights encode the topology of the links.

Theorem [LdM2]. *Let $p = 2$ and let $A \in \mathcal{A}$. Assume that A is homotopic (in the sense given just above) to a reduced configuration of $k = 2l + 1$ distinct points with weights n_1, \dots, n_k . Then*

- (i) *If $l = 1$, then X_A is diffeomorphic to $\mathbb{S}^{2n_1-1} \times \mathbb{S}^{2n_2-1} \times \mathbb{S}^{2n_3-1}$.*
- (ii) *If $l > 1$, then X_A is diffeomorphic to*

$$\#_{i=1}^k \mathbb{S}^{2d_i-1} \times \mathbb{S}^{2n-2d_i-2}$$

where $\#$ denotes the connected sum and where $d_i = n_i + \dots + n_{i+l-1}$ (the indices are taken modulo k).

In particular, X_A is diffeomorphic to $\mathbb{S}^3 \times \mathbb{S}^3 \times \mathbb{S}^1$ for the configuration on the right of the previous figures, and diffeomorphic to $\#(5)\mathbb{S}^3 \times \mathbb{S}^4$ (that is the connected sum of five copies of $\mathbb{S}^3 \times \mathbb{S}^4$) for the configuration on the left.

Example 0.6. Products. Let A and B be two admissible configurations of respective dimensions (n, p) and (n', p') . Set

$$C = \begin{pmatrix} A & 0 \\ -1 \dots -1 & 1 \dots 1 \\ 0 & B \end{pmatrix}$$

Then it is straightforward to check that C is admissible and that X_C is diffeomorphic to the product $X_A \times X_B$. In other words, *the class of links is stable by direct product*. In particular, the product of a link with an odd-dimensional sphere is a link. For example, letting

$$C = \begin{pmatrix} A & 0 \\ -1 \dots -1 & 1 \end{pmatrix}$$

then X_C is diffeomorphic to $X_A \times \mathbb{S}^1$.

Let \mathcal{L}_A denote the complex coordinate subspace arrangement of \mathbb{C}^n defined as follows :

$$(2) \quad L_I = \{z \in \mathbb{C}^n \mid z_i = 0 \text{ for } i \in I\} \in \mathcal{L}_A \iff L_I \cap X_A = \emptyset$$

and let \mathcal{S}_A be its complement in \mathbb{C}^n . In other words,

$$(3) \quad \mathcal{S}_A = \{z \in \mathbb{C}^n \mid 0 \in \mathcal{H}((A_i)_{i \in I_z})\}$$

where I_z is defined as in (1). We have:

Lemma 0.7. *The sets X_A and \mathcal{S}_A have the same homotopy type.*

Proof. This is an argument of foliations and convexity already used in [C-K-P], [LdM-V], [Me1] and [Me2]. We sketch the proof and refer to these articles for more details.

Let \mathcal{F} be the smooth foliation of \mathcal{S}_A given by the action:

$$(z, T) \in \mathcal{S}_A \times \mathbb{R}^p \longmapsto (z_i \cdot \exp\langle A_i, T \rangle)_{i=1}^n \in \mathcal{S}_A .$$

Let $z \in \mathcal{S}_A$ and let F_z be the leaf passing through z . Consider now the map:

$$f_z : w \in F_z \longmapsto \|w\|^2 = \sum_{i=1}^n |w_i|^2$$

Using the strict convexity of the exponential map, it is easy to check that each critical point of f_z is indeed a local minimum and that f_z cannot have two local minima and thus cannot have two critical points (see [C-K-P] for more details). Now as $z \in \mathcal{S}_A$, then, by definition, 0 is in the convex hull of $(A_i)_{i \in I_z}$. This implies that F_z is a closed leaf and does not accumulate onto $0 \in \mathbb{C}^n$ (see [Me1] and [Me2], Lemma 2.12 for more details). Therefore, the function f_z has a global minimum, which is unique by the previous argument. Finally, a straightforward computation shows that the minimum of f_z is the point w of F_z such that:

$$\sum_{i=1}^n A_i |w_i|^2 = 0$$

In particular $w/\|w\|$ belongs to X_A .

As a consequence of all that, the foliation \mathcal{F} is trivial and its leaf space can be identified with $X_A \times \mathbb{R}_*^+ \times \mathbb{R}^p$. More precisely, the map:

$$(4) \quad \Phi_A : (z, T, r) \in X_A \times \mathbb{R}^p \times \mathbb{R}_*^+ \longmapsto r \cdot (z_i \cdot \exp\langle A_i, T \rangle)_{i=1}^n \in \mathcal{S}_A$$

is a global diffeomorphism. \square

Let $A \in \mathcal{A}$. The real torus $(\mathbb{S}^1)^n$ acts on \mathbb{C}^n by :

$$(5) \quad (u, z) \in (\mathbb{S}^1)^n \times \mathbb{C}^n \longmapsto (u_1 \cdot z_1, \dots, u_n \cdot z_n) \in \mathbb{C}^n .$$

Let X be a subset of \mathbb{C}^n , which is invariant by the action (5). We define the *natural torus action on X* as the restriction of (5) to X . In particular, every link X_A for $A \in \mathcal{A}$ is endowed with a natural torus action, as well as \mathbb{S}^{2n-1} , \mathbb{D}^{2n} and $\overline{\mathbb{D}^{2n}}$.

Definition 0.8. Let $A \in \mathcal{A}$ and $B \in \mathcal{A}$. We say that X_A and X_B are *equivariantly diffeomorphic* and we write $X_A \underset{eq}{\sim} X_B$ if there exists a diffeomorphism between X_A and X_B respecting the natural torus actions on X_A and X_B .

More generally, we say that X_A and $X_B \times (\mathbb{S}^1)^k$ are *equivariantly diffeomorphic* and we write $X_A \underset{eq}{\sim} X_B \times (\mathbb{S}^1)^k$ if there exists a diffeomorphism between X_A and $X_B \times (\mathbb{S}^1)^k$ respecting the natural torus actions on X_A and on $X_B \times (\mathbb{S}^1)^k$ (seen as a subset of $\mathbb{C}^n \times \mathbb{C}^k$).

Lemma 0.9. *There exists $k \in \mathbb{N}$ and $B \in \mathcal{A}$ such that X_A is equivariantly diffeomorphic to $X_B \times (\mathbb{S}^1)^k$ and X_B is 2-connected.*

Proof. Assume that $X_A \cap \{z_1 = 0\}$ is vacuous. Let $A_i = \begin{pmatrix} a_i \\ \tilde{A}_i \end{pmatrix}$. As A_1 is not zero by weak hyperbolicity condition, we may assume without loss of generality that $a_1 \neq 0$. Then, there exists an equivariant diffeomorphism :

$$z \in X_A \longmapsto \left(\frac{z_1}{|z_1|}, \frac{z_2}{\sqrt{1-|z_1|^2}}, \dots, \frac{z_n}{\sqrt{1-|z_1|^2}} \right) \in \mathbb{S}^1 \times X_B$$

where B is defined as :

$$B = \left(\tilde{A}_2 - \tilde{A}_1 \frac{a_2}{a_1}, \dots, \tilde{A}_n - \tilde{A}_1 \frac{a_n}{a_1} \right) .$$

Now, B is admissible since, at each point, the system (S_B) has rank p . We may continue this process until we have $X_A \underset{eq}{\sim} X_B \times (\mathbb{S}^1)^k$ where the manifold $X_B \subset \mathbb{C}^{n-k}$ intersects each coordinate hyperplane of \mathbb{C}^{n-k} (note that X_B may be reduced to a point). This means that the subspace arrangement \mathcal{L}_B has complex codimension at least 2 in \mathbb{C}^n and thus, by transversality, S_B is 2-connected. By Lemma 0.7, this implies that X_B is 2-connected. \square

We will denote by \mathcal{A}_0 the set of admissible matrices giving rise to a 2-connected link. More generally, let $k \in \mathbb{N}$. We will denote by \mathcal{A}_k the set of admissible matrices giving rise to a link with fundamental group isomorphic to \mathbb{Z}^k . Of course, by Lemma 0.9, the set \mathcal{A} is the disjoint union of all of the \mathcal{A}_k for $k \in \mathbb{N}$. Still from Lemma 0.9, observe that k is exactly the number of coordinate hyperplanes of \mathbb{C}^n lying in \mathcal{L}_A .

The action (5) induces the following action of \mathbb{S}^1 onto a link X_A :

$$(6) \quad (u, z) \in \mathbb{S}^1 \times X_A \longmapsto u \cdot z \in X_A$$

We call this action the *diagonal action* of \mathbb{S}^1 onto X_A . We have

Lemma 0.10. *Let $A \in \mathcal{A}$. Then the Euler characteristic of X_A is zero.*

Proof. The diagonal action is the restriction to X_A of a free action of \mathbb{S}^1 onto \mathbb{S}^{2n-1} , so is free. Therefore, we may construct a smooth non vanishing vector field on X_A from a constant unit vector field on \mathbb{S}^1 . \square

The quotient space of X_A by the natural torus action is given by the positive solutions of the system

$$(7) \quad A \cdot r = 0 \quad \sum_{i=1}^n r_i = 1$$

By the weak hyperbolicity condition, it has maximal rank. We may thus parametrize its set of solutions by

$$(8) \quad r_i = \langle v_i, p \rangle + \epsilon_i \quad p \in \mathbb{R}^{n-p-1}$$

for some $v_i \in \mathbb{R}^{n-2p-1}$ and some $\epsilon_i \in \mathbb{R}$. Projecting onto \mathbb{R}^{n-p-1} , this gives an identification of the quotient of X_A by (5) as

$$(9) \quad K_A = \{u \in \mathbb{R}^{n-p-1} \mid \langle v_i, u \rangle \geq -\epsilon_i\}$$

Lemma 0.11. *Let $A \in \mathcal{A}_k$. The set K_A is a (full) simple convex polytope of dimension $n - p - 1$ with $n - k$ facets.*

Proof. As K_A is the quotient space of the compact manifold X_A by the action of a compact torus, it is a compact subset of \mathbb{R}^{n-p-1} .

Using (9), K_A is a bounded intersection of half-spaces, i.e. a (full) convex polytope of dimension $n - p - 1$.

For every subset I of $\{1, \dots, n\}$, let :

$$(10) \quad Z_I = \{z \in \mathbb{C}^n \mid z_i = 0 \text{ if } i \in I, z_i \neq 0 \text{ otherwise}\}$$

Let $z \in X_A$ and define I_z as in (1). Then, for every z' belonging to the orbit of z , we have $I_z = I_{z'}$ and thus the action respects each set Z_{I_z} . Moreover, the action induces a trivial foliation of $X_A \cap Z_{I_z}$.

It follows from all this that each k -face of K_A corresponds to a set of orbits of points z with fixed I_z , i.e. to a set $X_A \cap Z_{I_z}$. In particular, there is a numbering of the faces of K_A such that each j -face is numbered by the $(n - p - 1 - j)$ -uple I of the corresponding Z_I . As a first consequence, the number of facets of K_A is exactly equal to the number of coordinate hyperplanes of \mathbb{C}^n whose intersection with X_A is non vacuous, that is is equal to $n - k$ (see the remark just after the proof of Lemma 0.9). As a second consequence of this numbering, each vertex v corresponds to a $(n - p - 1)$ -uple I and each facet having v as vertex corresponds to a singleton of I : each vertex is thus attached to exactly $n - p - 1$ facets, i.e. the convex polytope is simple. \square

We will call the set K_A the *associate polytope* of X_A . We will denote by P_A the combinatorial type of K_A and by P_A^* the dual of P_A , which is thus the combinatorial type of a simplicial polytope.

Following the numbering introduced in the proof of the previous Lemma, we will see P_A as a poset whose elements are subsets of $\{1, \dots, n\}$ satisfying :

$$(11) \quad I \in P_A \iff L_I \cap X_A \neq \emptyset \iff Z_I \subset \mathcal{S}_A \iff 0 \in \mathcal{H}((A_i)_{i \in I^c})$$

where $I^c = \{1, \dots, n\} \setminus I$. We equip P_A with the order coming from the inclusion of faces. Of course P_A^* will be seen as the same set but with the reversed order.

Let (v_1, \dots, v_n) be a set of vectors of some \mathbb{R}^q . Following [B-L], we call Gale diagram of (v_1, \dots, v_n) a set of points (w_1, \dots, w_n) in \mathbb{R}^{n-q-1} verifying for all $I \subset \{1, \dots, n\}$:

$$(12) \quad 0 \in \text{Relint}(\mathcal{H}(w_i)_{i \in I}) \iff \mathcal{H}(v_i)_{i \in I^c} \text{ is a face of } \mathcal{H}(v_1, \dots, v_n)$$

where Relint denotes the relative interior of a set.

Now, consider K_A . Notice that we may assume that the ϵ_i are positive, taking as $(\epsilon_1, \dots, \epsilon_n)$ a particular solution of (7). Under this assumption, let $B_i = v_i/\epsilon_i$ for i between 1 and n . The convex hull of (B_1, \dots, B_n) is a realization of P_A^* . Using (12) and the weak hyperbolicity condition, it is easy to prove the following result.

Lemma 0.12 (cf [Me1], Lemma VII.2). *The set (B_1, \dots, B_n) is a Gale diagram of (A_1, \dots, A_n) .*

Notice that two Gale diagrams of the same set are combinatorially equivalent. We finish this part with a realization theorem.

Realization Theorem 0.13 (see [Me1], Theorem 14). *Let P be the combinatorial type of a simple convex polytope. Then, for every $k \in \mathbb{N}$ there exists $A(k) \in \mathcal{A}_k$ such that $P_{A(k)} = P$. In particular, every combinatorial type of simple convex polytope can be realized as the associate polytope of some 2-connected link.*

Proof. Let P be the combinatorial type of a simple polytope and let P^* be its dual. Realize P^* in \mathbb{R}^q (with $q = \dim P^*$) as the convex hull of its vertices (v_1, \dots, v_n) .

Let us start with $k = 0$. By Lemma 0.12, it is sufficient to find $A(0) \in \mathcal{A}_0$ such that P^* is a Gale diagram of $A(0)$.

This can be done by taking a Gale transform ([Gr], p.84) of (v_1, \dots, v_n) , that is by taking the transpose of a basis of the solutions of :

$$\begin{cases} \sum_{i=1}^n x_i v_i = 0 \\ \sum_{i=1}^n x_i = 0 \end{cases}$$

We thus obtain n vectors (A_1, \dots, A_n) in \mathbb{R}^{n-q-1} . Set $A(0) = (A_1, \dots, A_n)$. We have now to check that $A(0) \in \mathcal{A}_0$. By an immediate computation, the Gale transform (A_1, \dots, A_n) satisfies the Siegel condition. Assume that 0 belongs to $\mathcal{H}(A_i)_{i \in I}$ for some $I = \{i_1, \dots, i_p\}$. Then $\mathcal{H}(v_i)_{i \in I^c}$ is a face of P^* of dimension less than $n-p-2$ with $n-p$ vertices. This face cannot be simplicial. Contradiction. The weak hyperbolicity condition is fulfilled.

Finally, as $P^* = P_{A(0)}^*$ has n vertices, the link $X_{A(0)}$ intersects each coordinate hyperplane of \mathbb{C}^n so is 2-connected (see Lemma 0.7).

Now, using the construction detailed in Example 0.6, we can find $A(k) \in \mathcal{A}_k$ for every k such that $P_{A(k)} = P$. \square

Note that, when P^* is the n -simplex, the previous construction (for a 2-connected link) yields $p = 0$ and the corresponding X_A is the standard sphere of \mathbb{C}^{n-1} .

PART I: ELEMENTARIES SURGERIES, FLIPS AND WALL-CROSSING

1. Submanifolds of X_A given by a face of P_A

Let $A \in \mathcal{A}$ and let F be a proper face of P_A numbered by I . Then, we may associate to F and A a link which we will denote by X_F (by a slight abuse of notation), smoothly embedded in X_A . To do this, just recall by (11) that

$$B = (A_j)_{j \in I^c}$$

is admissible and thus gives rise to a link X_B in \mathbb{C}^{n-b} where b is the cardinal of I . Now, X_B is naturally embedded into X_A as X_F by defining:

$$(13) \quad X_F = L_I \cap X_A$$

where L_I was defined in (2). Moreover, the natural torus action of $(\mathbb{S}^1)^n$ onto X_A gives by restriction to L_I the natural torus action of $(\mathbb{S}^1)^{n-b}$ onto $X_F \underset{eq}{\sim} X_B$.

We have

Proposition 1.1. *Let $A \in \mathcal{A}$ and let F be a face of P_A of codimension b . Then,*

(i) X_F is a smooth submanifold of codimension $2b$ of X_A which is invariant under the natural torus action.

(ii) The quotient space of X_F by the natural torus action is $F \subset K_A$.

(iii) X_F has trivial invariant tubular neighborhood in X_A .

Proof. The points (i) and (ii) are direct consequences of the definition (13) of X_F . Let us prove (iii). For $\epsilon > 0$, define:

$$L_I^\epsilon = \{z \in \mathbb{C}^n \mid \sum_{i \in I} |z_i|^2 < \epsilon\}.$$

and

$$W_F^\epsilon = X_A \cap L_I^\epsilon.$$

For simplicity, assume that $I = \{1, \dots, b\}$. Set $y_j = z_j$ for $1 \leq j \leq b$ and $w_j = z_{b+j}$ for $1 \leq j \leq n-b$. For $\epsilon > 0$ sufficiently small, the map

$$\pi : (y, w) \in W_F^\epsilon \longmapsto \frac{1}{\sqrt{\epsilon}} \cdot y \in \mathbb{D}^{2b}$$

is a smooth submersion. Indeed, a straightforward computation shows that the previous map is a submersion as soon as W_F^ϵ does not intersect any of the sets

$$\{w_j = 0 \mid b+j \in J\}$$

for J satisfying $F \cap F_J = \emptyset$ (cf the proof of Lemma 0.3). As this submersion has compact fibers, it is a locally trivial fiber bundle by Ehresmann's Lemma. It is even a trivial bundle, since \mathbb{D}^{2b} is contractible. Notice now that the action of $(\mathbb{S}^1)^n$ onto W_F^ϵ can be decomposed into an action of $(\mathbb{S}^1)^b$ leaving fixed the y -coordinates and an action of $(\mathbb{S}^1)^{n-b}$ leaving fixed the w -coordinates. The fibers of the previous submersion are invariant with respect to the action of $(\mathbb{S}^1)^{n-b}$ whereas the disk \mathbb{D}^{2b} is invariant with respect to the action of $(\mathbb{S}^1)^b$. All this implies that W_F^ϵ is equivariantly diffeomorphic to $X_F \times \mathbb{D}^{2b}$ endowed with its natural torus action. \square

In the case where F is a simplicial face, then we can identify precisely X_F .

Proposition 1.2. *Let $A \in \mathcal{A}_0$. The following statements are equivalent:*

- (i) X_A is equivariantly diffeomorphic to the unit euclidean sphere \mathbb{S}^{2n-1} of \mathbb{C}^n equipped with the action induced by the standard action of $(\mathbb{S}^1)^n$ on \mathbb{C}^n .
- (ii) X_A is diffeomorphic to \mathbb{S}^{2n-1} .
- (iii) X_A has the homotopy type of \mathbb{S}^{2n-1} .
- (iv) P_A is the $(n-1)$ -simplex.

Proof. When $p = 0$, the link X_A is the unit euclidean sphere \mathbb{S}^{2n-1} of \mathbb{C}^n and the natural torus action comes from the standard action of $(\mathbb{S}^1)^n$ on \mathbb{C}^n . On the other hand, when P_A is the $(n-1)$ -simplex, we have $p = 0$, since the dimension of P_A is $n - p - 1$; in this way, we get an equivalence between (i) and (iv).

Of course, (i) implies (ii) and (ii) implies (iii). So assume now that X_A is a homotopy sphere of dimension $2n - 1$. Recall that a polytope with n vertices is k -neighbourly if its k -skeleton coincides with the k -skeleton of a $(n-1)$ -simplex (cf [Gr], Chapter 7). In particular, a $(n-1)$ -simplex is $(n-2)$ -neighbourly. We will use the following Lemma:

Lemma 1.3. *Let $A \in \mathcal{A}_0$. The link X_A is $(2k)$ -connected if and only if P_A^* is the combinatorial type of a $(k-1)$ -neighbourly polytope.*

Proof of Lemma 1.3. Assume that P_A^* is $(k-1)$ -neighbourly. This means that every subset of $\{1, \dots, n\}$ of cardinal less than k numbers a face of P_A^* . Using (2) and (11), this means that every coordinate subspace of \mathcal{L}_A has at least complex codimension $k+1$. By transversality, this implies that \mathcal{S}_A is $(2k)$ -connected and thus, by Lemma 0.7, the link X_A is $(2k)$ -connected.

Now, assume moreover that P_A^* is not k -neighbourly. Then, there exists a coordinate subspace L_I in \mathcal{L}_A of codimension $k+1$. The unit sphere \mathbb{S}^{2k+1} of the complementary coordinate subspace L_I^c lies in \mathcal{S}_A and is not null-homotopic in \mathcal{S}_A . Therefore, \mathcal{S}_A and thus X_A are not $(2k+1)$ -connected. \square

Applying this Lemma gives that P_A^* is $(n-2)$ -neighbourly. But its dimension being $n-p-1$, this implies that p equals 0 and that it is the $(n-1)$ -simplex. Therefore (iii) implies (iv). \square

Corollary 1.4. *Let $A \in \mathcal{A}$. Then P_A is the $(n-p-1)$ -simplex if and only if X_A is equivariantly diffeomorphic to $\mathbb{S}^{2n-2p-1} \times (\mathbb{S}^1)^p$.*

Proof. Assume that P_A is the $(n-p-1)$ -simplex. The polytope P_A having $n-p$ facets, we know that $A \in \mathcal{A}_p$. By Lemma 0.9, there exists $B \in \mathcal{A}_0$ such that $X_A \underset{eq}{\sim} X_B \times (\mathbb{S}^1)^p$. Now, this implies that $P_B = P_A$, so that P_B is the $(n-p-1)$ -simplex. We conclude by Proposition 1.2.

The converse is obvious by Proposition 1.2. \square

Corollary 1.5. *Let F be a simplicial face of P_A of codimension b . Then X_F is equivariantly diffeomorphic to $\mathbb{S}^{2n-2p-2b-1} \times (\mathbb{S}^1)^p$.*

2. Flips of simple polytopes

We will make use of the notion of flips of simple polytopes. This Section is deeply inspired from [Ti], §3 (see also [McM]). The main difference is that we only deal with combinatorial types of simple polytopes. Recall that two convex polytopes are combinatorially equivalent if there exists a bijection between their posets of faces which respects the inclusion. Two combinatorially equivalent convex polytopes are

PL-homeomorphic and the classes of convex polytopes up to combinatorial equivalence coincide with the classes of convex polytopes up to PL-homeomorphism. In the sequel, *we make no distinction between a convex polytope and its combinatorial class*. No confusion should arise from this abuse.

Definition 2.1. Let P and Q be two simple polytopes of same dimension q . Let W be a simple polytope of dimension $q + 1$. We say that W is a *cobordism* between P and Q if P and Q are disjoint facets of W .

In addition, if $W \setminus (P \sqcup Q)$ contains no vertex, we say that W is a trivial cobordism; if $W \setminus (P \sqcup Q)$ contains a unique vertex, we say that W is an *elementary cobordism* between P and Q .

In the next Section, we will relate this notion of cobordism of polytopes to the classical notion of cobordism of manifolds (here of links) via the Realization Theorem 0.13. This will justify the terminology.

Notice that the existence of a trivial cobordism between P and Q implies $P = Q$; notice also that a cobordism of simple polytopes may be decomposed into a finite number of elementary cobordisms.

Now, let W be an elementary cobordism between P and Q and let v denote the unique vertex of $W \setminus (P \sqcup Q)$. An edge attached to v has another vertex which may belong to P or Q . Let us say that, among the $(q + 1)$ edges attached to v , then a of them join P and b of them join Q .

Definition 2.2 (compare with [Ti], §3.1). We call *index of v* or *index of the cobordism* the couple of integers (a, b) such that a (respectively b) denotes the number of edges of W attached to v and joining P (respectively Q).

Let P and Q be two simple polytopes of same dimension q . Assume that there exists an elementary cobordism W between them and let (a, b) denote its index. Then we say that Q is obtained from P by performing on P a *flip* of type (a, b) , or that P undergoes a *flip* of type (a, b) .

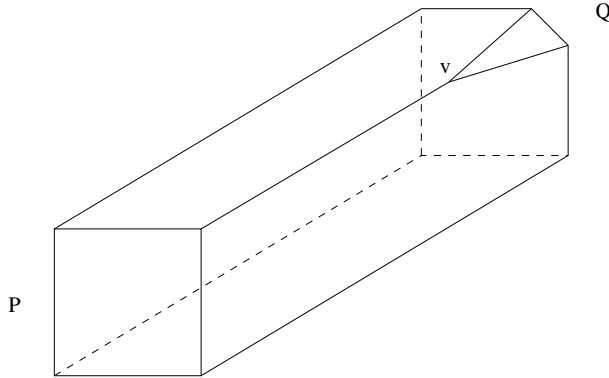

The previous picture is an example of a flip of type $(1, 2)$.

Notice that if Q is obtained from P by a flip of type (a, b) , then obviously P is obtained from Q by a flip of type (b, a) . Note also that we have the obvious relations $a + b = q + 1$ and $1 \leq a \leq q$ and $1 \leq b \leq q$.

Lemma 2.3. *Every simple convex q -polytope can be obtained from the q -simplex by a finite number of flips.*

Proof. Let P be a simple convex q -polytope. Consider the product $P \times [0, 1]$ and cut off one vertex of $P \times \{1\}$ by a generic hyperplane. The resulting polytope, let us call it W , is simple and realizes a cobordism between P (seen as $P \times \{0\}$) and the q -simplex (seen as the simplicial facet created by the cut). As observed above, this cobordism may be decomposed into a finite number of elementary cobordisms, that is of flips. \square

Following [Ti], §3.2, it is possible to give a more precise description of a flip of type (a, b) . We use the same notations as before. Let F_1, \dots, F_{q+1} be the facets of W attached to the vertex v . As W is simple, a sufficiently small neighborhood of v in W is PL-isomorphic to the neighborhood of a point in a $(q + 1)$ -simplex. As a consequence, each facet F_i contains all the edges attached to v but one. Assume that (F_1, \dots, F_b) contain all the edges joining P , whereas $(F_{b+1}, \dots, F_{q+1})$ contain all the edges joining Q .

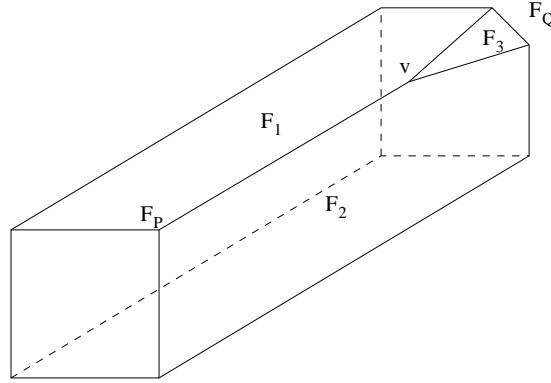

Let $F_P = P \cap F_1 \cap \dots \cap F_b$ and $F_Q = Q \cap F_{b+1} \cap \dots \cap F_{q+1}$. The face $F_1 \cap \dots \cap F_b$ (respectively $F_{b+1} \cap \dots \cap F_{q+1}$) is a pyramid with base F_P (respectively F_Q) and apex v . As these faces are simple as convex polytopes, this implies that F_P and F_Q are simplicial. More precisely, if $a = 1$ (respectively $b = 1$), then F_P (respectively F_Q) is a point and $F_P \cap F_{q+1} = \emptyset$ (respectively $F_Q \cap F_1 = \emptyset$). Otherwise F_P is a simplicial face of strictly positive dimension $q - b = a - 1$ with facets $F_P \cap F_{b+1}, \dots, F_P \cap F_{q+1}$ (respectively F_Q is a simplicial face of strictly positive dimension $b - 1$ with facets $F_Q \cap F_1, \dots, F_Q \cap F_b$).

In the previous picture, F_P is a point and F_Q is a segment. There are three facets F_1, F_2, F_3 containing v .

The flip destroys the face F_P and creates the face F_Q in its place. Continuously, the face F_P is homothetically reduced to a point and then this point is inflated to the face F_Q . In a more static way of thinking, a trivial neighborhood of F_P in P is cut off and a closed trivial neighborhood of F_Q in Q is glued. In particular, the simple polytope obtained from P by cutting off a neighborhood of F_P by a hyperplane and the polytope obtained from Q by cutting off a neighborhood of F_Q by a hyperplane are the same (up to combinatorial equivalence). Let us denote by T this polytope.

Definition 2.4. The simple convex polytope T will be called the *transition polytope* of the flip between P and Q .

Remark 2.5. This definition is not the same as the definition of transition polytope of [Ti].

Notice that T has just one extra facet (with respect to P and Q), except for the special case of index $(1, 1)$. Let us call it F .

The following picture describes a flip of type $(2, 2)$. We simply drew the initial state P and the final state Q and indicated the two edges F_P of vertices A and B and F_Q of vertices A and B' .

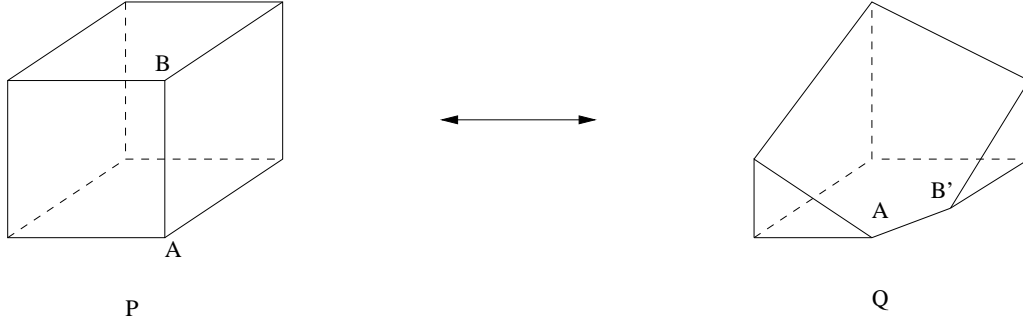

To visualize the 4-dimensional cobordism between P and Q , just perform the following homotopy: move the hyperplane supporting the upper facet of the cube to the bottom in order to contract the edge AB to its lower vertex A ; then move the hyperplane supporting the right facet of the cube to the right in order to inflate the transverse edge AB' , keeping A fixed. The transition polytope T is:

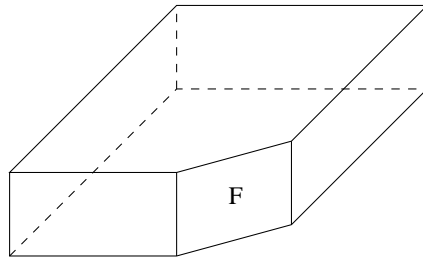

Proposition 2.6.

(i) The extra facet F of T is combinatorially equivalent to $F_P \times F_Q$, that is to a product of a $(a - 1)$ -simplex by a $(b - 1)$ -simplex.

(ii) A neighborhood of F_P in P (respectively F_Q in Q) is combinatorially equivalent to $F_P \times \mathcal{C}(F_Q)$ (respectively $(F_P) \times F_Q$), where $\mathcal{C}(F_P)$ (respectively $\mathcal{C}(F_Q)$) denotes the pyramid with base F_P (respectively F_Q).

Proof. Assume that P is a simplex. Cut off a neighborhood of F_P by a hyperplane. The created facet is combinatorially equivalent to a product of the simplex F_P by a simplex S of complementary dimension, whereas the cut part is combinatorially equivalent to $F_P \times \mathcal{C}(S)$, with the notation introduced in the statement of the Proposition. Both statements follows then since the neighborhood of a simplicial

face in a simple convex polytope is PL-homeomorphic to the neighborhood of a face of same dimension in a simplex. \square

In particular, the combinatorial types of P and Q can be recovered from that of T (up to exchange of P and Q): the face poset of P is obtained from that of T by identifying two faces $A \times B$ and $A \times B'$ of $F_P \times F_Q$ and the face poset of Q is obtained from that of T by identifying two faces $A \times B$ and $A' \times B$ of $F_P \times F_Q$.

Combining this observation with Proposition 2.6 yields

Corollary 2.7 (Rigidity of a flip). *Let Q and Q' be obtained from P by a flip of type (a, b) along the same simplicial face F_P . Then Q and Q' are combinatorially equivalent.*

Given a simple convex polytope T with a facet F combinatorially equivalent to a product of simplices $S_{a-1} \times S_{b-1}$, we may define two posets from the poset of face of T making the identifications explained just before Corollary 2.7. These two posets *may or may not be* the face posets of some simple convex polytopes P and Q (see the examples below). In the case they are, we write $P = F/S_{a-1}$ and $Q = F/S_{b-1}$. Of course, in the case of a flip, with the same notations as before, we have $P = T/F_P$ and $Q = T/F_Q$. The next Corollary is a reformulation of Corollary 2.7 which will be useful in the sequel.

Corollary 2.8. *Let Q be obtained from P by a flip along F_P and let T be the transition polytope. Let P' and Q' be two simple convex polytopes satisfying $P' = P/F_P$ and $Q' = Q/F_Q$. Then P and P' are combinatorially equivalent as well as Q and Q' .*

Let us describe another way of visualizing a flip. Let P be a simple polytope and F_P a simplicial face of dimension $a - 1$ of P . Let Q be a simple polytope and assume that Q is obtained from P by performing a flip on F_P . Cut off F_P by a hyperplane, you obtain the transition polytope T . Consider now a simplex Δ of same dimension as P and a $(a - 1)$ -face F' of Δ . Cut off F' by a hyperplane, you obtain, with the notations of Proposition 2.6, the polytope $\mathcal{F}' \times S$, where S is the maximal simplicial face of Δ without intersection with F' . It follows from Proposition 2.6 and Corollary 2.8 that the polytope Q is combinatorially equivalent to the gluing of $T = P \setminus F_P \times \mathcal{C}(S)$ and of $\Delta \setminus F_P \times \mathcal{C}(S) = (F') \times S$.

Finally, from all that precedes, a complete combinatorial characterization of a flip may easily be derived. In the following statement, we consider also flips of type $(q + 1, 0)$, that is destruction of a q -simplex.

Proposition 2.9 ([Ti], Theorem 3.4.1). *Let Q be a simple polytope obtained from P by a flip of type (a, b) . Using the same notations as before, we have*

- (i) *If $a \neq 1$, the facets $P \cap F_{b+1}, \dots, P \cap F_{q+1}$ undergo flips of index $(a - 1, b)$.*
- (ii) *The facets $P \cap F_1, \dots, P \cap F_b$ undergo flips of index $(a, b - 1)$.*
- (iii) *The other facets keep the same combinatorial type.*

It is however important to remark that the notion of “combinatorial flip” is not well defined in the class of simple polytopes: the result of cutting off a neighborhood of a simplicial face of a simple polytope and gluing in its place the neighborhood of another simplex may *not be* a convex polytope. Let us give three examples of this crucial fact.

Example 2.10. Let P be the 3-simplex. Then, the result of cutting off an edge AB and gluing in its place a transverse edge (that is the result of a “combinatorial 2-flip”) is not the combinatorial type of a 3-polytope.

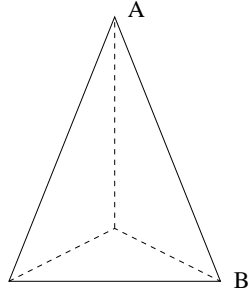

Example 2.11. More generally, let P be a simple convex polytope and F_P a simplicial face of dimension q , with $q > 2$. Then, we cannot perform a flip along a strict face of F_P .

Example 2.12. Consider the following polytope (“hexagonal book”).

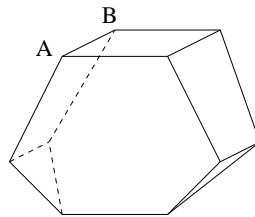

Then, the 2-flip along the edge AB does not exist.

We finish with Section with the following result.

Proposition 2.13. *Let P be a simple convex polytope and let Q be obtained from P by a flip of type (a, b) . Let W be the elementary cobordism between P and Q . Assume that P has d facets. Then W has $d + 2$ facets if $a \neq 1$ and $d + 3$ facets if $a = 1$.*

Proof. In the special case where $a = b = 1$, then $P = Q$ is the segment and W is the pentagon.

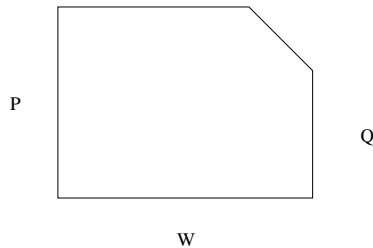

Thus d is equal to 2 and W has $d + 3$ facets.

Assume that a and b are different from one. Then P and Q have the same number d of facets and there is a 1 : 1 correspondance between the facets of P and that of Q : according to Proposition 2.9, each facet of P is transformed through a flip (case (i) or (ii)) or just shifted (case (iii)) to a facet of Q . There are d facets

of W which realize the previous trivial and elementary cobordisms. Adding to this number 2 to take account of P and Q gives that W has $d + 2$ facets.

Assume that $a = 1$ and $b \neq 1$. Then, as before, the d facets of P correspond to d facets of W realizing cobordisms with d facets of Q . But this time Q has $d + 1$ facets and this extra facet belongs to an extra facet of W which does not intersect P . Adding the two facets P and Q gives thus $d + 3$ facets for W .

Finally, when $b = 1$ and $a \neq 1$, then the polytope Q has $d - 1$ facets; interverting the rôle of P and Q in the previous case yields that W has $(d - 1) + 3 = d + 2$ facets. \square

3. Elementary surgeries

In this Section, we translate the notions of cobordisms and flips of simple polytopes at the level of the links.

We will make use several times of the following result:

Theorem of Extension of Equivariant Isotopies. *Let M and V be smooth compact manifolds endowed with a smooth torus action. Let $f : V \times [0, 1] \rightarrow M$ be an equivariant isotopy. Then f can be extended to an equivariant diffeotopy $F : M \times [0, 1] \rightarrow M$ such that $(F_t)|_V \equiv f_t$ for $0 \leq t \leq 1$.*

A proof of this fact *in the non equivariant case* can be found in [Hi], Chapter 8. Now, we may assume that the diffeotopy extending an equivariant isotopy is also equivariant (see [Br], Chapter VI.3), so that this Theorem holds in the equivariant setting.

Let $A \in \mathcal{A}$ and let F be a *simplicial* face of P_A of codimension b . As explained in Section 1, it gives rise to an invariant submanifold X_F of X_A (see (13)) with trivial invariant tubular neighborhood.

By Corollary 1.5, as F is simplicial of codimension b , then X_F is equivariantly diffeomorphic to $\mathbb{S}^{2a-1} \times (\mathbb{S}^1)^p$ (where $a = n - p - b$).

But now, we can perform on X_A an equivariant surgery as follows: choose a closed invariant tubular neighborhood

$$\nu : X_F \times \overline{\mathbb{D}^{2b}} \longrightarrow \overline{W_F}$$

where $W_F \subset X_A$ is an open (invariant) neighborhood of X_F . Then fix an equivariant identification

$$\xi : \mathbb{S}^{2a-1} \times (\mathbb{S}^1)^p \longrightarrow X_F .$$

Finally, set

$$\phi \equiv \nu \circ (\xi, \text{Id}) : \mathbb{S}^{2a-1} \times (\mathbb{S}^1)^p \times \overline{\mathbb{D}^{2b}} \longrightarrow \mathbb{S}^{2a-1} \times (\mathbb{S}^1)^p \times \overline{\mathbb{D}^{2b}} .$$

We call ϕ a *standard product neighborhood* of X_F .

Then, remove W_F , and glue $\overline{\mathbb{D}^{2a}} \times (\mathbb{S}^1)^p \times \mathbb{S}^{2b-1}$ by ϕ along the boundary. We obtain thus a topological manifold Y . Since the natural torus actions on $\overline{\mathbb{D}^{2a}} \times (\mathbb{S}^1)^p \times \mathbb{S}^{2b-1}$ and on $\mathbb{S}^{2a-1} \times (\mathbb{S}^1)^p \times \overline{\mathbb{D}^{2b}}$ coincide on their common boundary, this topological manifold supports a continuous action of $(\mathbb{S}^1)^n$ which extends the natural torus action on $X_A \setminus W_F$. Using invariant collars for the boundary of $X_A \setminus W_F$ and for the boundary of $\overline{\mathbb{D}^{2a}} \times (\mathbb{S}^1)^p \times \mathbb{S}^{2b-1}$, we may smooth Y as well as the action in such a way that the natural inclusions of $X_A \setminus W_F$ and $\overline{\mathbb{D}^{2a}} \times$

$(\mathbb{S}^1)^p \times \mathbb{S}^{2b-1}$ in it are equivariant embeddings. As a consequence of the Theorem of Extension of Equivariant Isotopies, it can be proven that, up to equivariant diffeomorphism, there are no other differentiable structure and smooth action on Y satisfying this property (see [Hi], Chapter 8 for the non equivariant case). The manifold Y endowed with such a differentiable structure and such a smooth torus action is the result of our surgery.

Here is a combinatorial description of this surgery. Recall that P_A identifies with the quotient of X_A by the natural torus action. The neighborhood W_F corresponds then to a neighborhood of F in P_A . Consider now a simplex Δ of same dimension as P_A and a face F' of Δ of same dimension as F . By Corollary 1.4, the link X_Δ corresponding to Δ is equivariantly diffeomorphic to $\mathbb{S}^{2n-2p-1} \times (\mathbb{S}^1)^p$ and a neighborhood $W_{F'}$ of $X_{F'}$ (coming from a neighborhood of F' in Δ) is equivariantly diffeomorphic to W_F . The complement $X_\Delta \setminus W_{F'}$ is equivariantly diffeomorphic to

$$(\mathbb{S}^{2n-2p-1} \setminus \mathbb{S}^{2a-1} \times \mathbb{D}^{2b}) \times (\mathbb{S}^1)^p = \overline{\mathbb{D}^{2a}} \times \mathbb{S}^{2b-1} \times (\mathbb{S}^1)^p$$

The surgery consists of removing W_F in X_A and $W_{F'} \underset{eq}{\simeq} W_F$ in X_Δ and of gluing the resulting manifolds along their boundary:

$$(14) \quad X_A \setminus W_F \cup_\psi X_\Delta \setminus W_{F'}$$

The map ψ may be written as $\phi \circ (\phi')^{-1}$ for ϕ (respectively ϕ') a standard product neighborhood of X_F in X_A (respectively of $X_{F'}$ in X_Δ).

We conclude from this description and from Corollary 2.8 that, at the level of the associate polytope, this surgery coincides exactly to a flip.

Definition 3.1. Let $A \in \mathcal{A}$. Let (a, b) be a couple of positive integers satisfying $a + b = n - p$. Let F be a simplicial face of P_A of codimension b . We call *elementary surgery of type (a, b) along X_F* the following equivariant transformation of X_A :

$$(X_A \setminus \mathbb{S}^{2a-1} \times (\mathbb{S}^1)^p \times \mathbb{D}^{2b}) \cup_\phi (\overline{\mathbb{D}^{2a}} \times (\mathbb{S}^1)^p \times \mathbb{S}^{2b-1}).$$

Here $\mathbb{S}^{2a-1} \times (\mathbb{S}^1)^p \times \mathbb{D}^{2b}$ is embedded in X_A by means of a standard product neighborhood ϕ and the gluing is made along the common boundary by the restriction of ϕ to this boundary.

In the particular case where $a = 1$, we restrict the definition of elementary surgery to the case where X_A is equivariantly diffeomorphic to $X_B \times \mathbb{S}^1$ and where the surgery is made as follows

$$(X_B \setminus (\mathbb{S}^1)^p \times \mathbb{D}^{2b}) \times \mathbb{S}^1 \cup_\phi ((\mathbb{S}^1)^p \times \mathbb{S}^{2b-1}) \times \overline{\mathbb{D}^2}.$$

These surgeries depend *a priori* on the choice of ϕ . But, in fact

Lemma 3.2. *The result of an elementary surgery is independent of the choice of ϕ , that is: given two standard product neighborhoods ϕ and ϕ' , the manifolds*

$$X_\phi = (X_A \setminus \mathbb{S}^{2a-1} \times (\mathbb{S}^1)^p \times \mathbb{D}^{2b}) \cup_\phi (\overline{\mathbb{D}^{2a}} \times (\mathbb{S}^1)^p \times \mathbb{S}^{2b-1}).$$

and

$$X_{\phi'} = (X_A \setminus \mathbb{S}^{2a-1} \times (\mathbb{S}^1)^p \times \mathbb{D}^{2b}) \cup_{\phi'} (\overline{\mathbb{D}^{2a}} \times (\mathbb{S}^1)^p \times \mathbb{S}^{2b-1}).$$

are equivariantly diffeomorphic.

Proof. It is enough to prove that ϕ and ϕ' are equivariantly isotopic. As in the non equivariant case, the uniqueness of gluing for isotopic diffeomorphisms is a direct consequence of the Theorem of Extension of Isotopies.

Now, any two invariant tubular neighborhoods of X_F are equivariantly isotopic [Br], Chapter VI.2. Thus, we may assume that

$$\phi(\mathbb{S}^{2a-1} \times (\mathbb{S}^1)^p \times \overline{\mathbb{D}^{2b}}) = \phi'(\mathbb{S}^{2a-1} \times (\mathbb{S}^1)^p \times \overline{\mathbb{D}^{2b}})$$

and that the map $f = \phi' \circ \phi^{-1}$ is of the form

$$(z, \exp it, w) \in \mathbb{S}^{2a-1} \times (\mathbb{S}^1)^p \times \overline{\mathbb{D}^{2b}} \longmapsto (f_1(z, \exp it), f_2(z, \exp it), A(z, \exp it) \cdot w)$$

where A is a smooth invariant map from $\mathbb{S}^{2a-1} \times (\mathbb{S}^1)^p$ to the group of matrices SO_{2b} . Moreover, the equivariance of f implies that each matrix $A(z, \exp it)$ is of the form

$$\begin{pmatrix} \exp i\theta_1 & & 0 \\ & \ddots & \\ 0 & & \exp i\theta_b \end{pmatrix}$$

We may thus easily equivariantly isotope f to

$$(z, \exp it, w) \in \mathbb{S}^{2a-1} \times (\mathbb{S}^1)^p \times \overline{\mathbb{D}^{2b}} \longmapsto (f_1(z, \exp it), f_2(z, \exp it), w)$$

and it is enough to prove that the equivariant diffeomorphism $\tilde{f} = (f_1, f_2)$ of $\mathbb{S}^{2a-1} \times (\mathbb{S}^1)^p$ is equivariantly isotopic to the identity.

Still by equivariance, we have

$$\tilde{f}(z, \exp it) = \exp it \cdot \tilde{f}(z, 1)$$

so we may equivariantly isotope \tilde{f} to a map of the form

$$(z, \exp it) \in \mathbb{S}^{2a-1} \times (\mathbb{S}^1)^p \longmapsto (h(z), \exp it) \in \mathbb{S}^{2a-1} \times (\mathbb{S}^1)^p$$

where h is an equivariant diffeomorphism of \mathbb{S}^{2a-1} . Finally, using Lemma 3.3 (stated and proved below), h and thus f are equivariantly isotopic to the identity. This is enough to show the result. \square

Lemma 3.3. *Let h be an equivariant diffeomorphism of the sphere \mathbb{S}^{2a-1} . Then f is equivariantly isotopic to the identity.*

Proof. We proceed by induction on a . For $a = 1$, the map h is a translation so the result is clear. Assume the result for some $a \geq 1$ and let h be an equivariant diffeomorphism of \mathbb{S}^{2a+1} .

By equivariance, the submanifold

$$X = \{z \in \mathbb{S}^{2a+1} \mid z_{a+1} = 0\} \underset{eq}{\sim} \mathbb{S}^{2a-1}$$

is invariant by h .

We shall construct two invariant tubular neighborhoods of X . First, consider, for $0 < \epsilon < 1$,

$$X_\epsilon = \{z \in \mathbb{S}^{2a+1} \mid |z_{a+1}|^2 \leq \epsilon\} \underset{eq}{\sim} \mathbb{S}^{2a-1} \times \overline{\mathbb{D}^2}$$

and the equivariant bundle map

$$z \in X_\epsilon \xrightarrow{\xi} \frac{1}{\sqrt{1 - |z_{a+1}|^2}}(z_1, \dots, z_a, 0) \in X$$

Secondly, let f be the restriction of h^{-1} to X . Set $\tilde{X}_\epsilon = f^*X_\epsilon$ (pull-back bundle by f), and let \tilde{f} denote the natural map between \tilde{X}_ϵ and X_ϵ . The map $h \circ \tilde{f}$ defines the second tubular neighborhood of X in \mathbb{S}^{2a+1} .

By [Br], Chapter VI.3, there exists an equivariant isotopy of tubular neighborhoods

$$H: X_\epsilon \times [0, 1] \longrightarrow \mathbb{S}^{2a+1}$$

with $H_0 \equiv \text{Id}$ and $H_1(X_\epsilon) \equiv h \circ \tilde{f}(\tilde{X}_\epsilon) \equiv h(X_\epsilon)$. In particular, H_1 differs from h by an equivalence of equivariant bundles

$$\begin{array}{ccc} X_\epsilon & \xrightarrow{h^{-1} \circ H_1} & X_\epsilon \\ \xi \downarrow & & \xi \downarrow \\ X & \xrightarrow{f} & X \end{array}$$

Since $X \underset{eq}{\sim} \mathbb{S}^{2a-1}$, by induction, the map f is equivariantly isotopic to the identity and it is easy to lift this isotopy to an isotopy G between H_1 and h .

Combining H and G , we obtain an equivariant isotopy

$$F: [0, 1] \times X_\epsilon \longrightarrow \mathbb{S}^{2a+1}$$

such that F_0 is the natural inclusion map and $F_1 \equiv h|_{X_\epsilon}$.

By the Theorem of Extension of Equivariant Isotopies, F extends to an equivariant diffeotopy between some map g with $g|_{X_\epsilon} \equiv h$ and the identity. As this construction can be achieved for any choice of $0 < \epsilon < 1$, we may assume that $g \equiv h$ on the whole sphere. \square

We note that the result of such a surgery *may or may not* be a link. Indeed, in Examples 2.10, 2.11 and 2.12, we may perform elementary surgeries but the quotient space of the new manifold by the action of the real torus cannot be identified with a simple polytope, therefore the new manifold is not a link.

Consider now the following more subtle case. Let X_A be a link and let Q be the simple convex polytope obtained from P_A by performing a flip of type (a, b) along some simplicial face F . Then, call Y the manifold obtained from X_A by performing an elementary surgery of type (a, b) along X_F . As the surgery is equivariant, the manifold Y is endowed with a smooth action of the real torus on it. It follows from Corollary 2.8 that the quotient space of Y by this action can be identified with Q . This means that this quotient space is in bijection with Q , that the orbit over a point in the interior of Q is $(\mathbb{S}^1)^n$, whereas the orbit over a point in the interior

of a facet of Q is $(\mathbb{S}^1)^{n-1}$ and so on. We still call associate polytope the resulting polytope. Finally, each closed face of Q corresponds to an invariant submanifold of Y with trivial invariant tubular neighborhood. In fact, every such face S is obtained from a face R of P_A by a certain flip, as precised in Proposition 2.9. The corresponding invariant submanifold Y_S is thus obtained from X_R by performing the corresponding elementary surgery. More precisely, write

$$Y = (X_A \setminus W_F) \cup_{\psi} (X_{\Delta} \setminus W_{F'})$$

as in (14), then we have

$$Y_S = (X_R \setminus W_F \cap X_R) \cup_{\psi} (X_{R'} \setminus W_{F'} \cap X_{R'})$$

for some well-chosen face R' of Δ . Let

$$\nu : X_R \times \mathbb{D}^{2b'} \longrightarrow W_R \subset X_A$$

be a trivial invariant tubular neighborhood of X_R (we denote the codimension of X_R in X_A by b'). We assume that W_R is small enough to have

$$\nu^{-1}(W_R \cap W_F) = (X_R \cap W_F) \times \mathbb{D}^{2b'}$$

Then the composition

$$(X_{R'} \cap W_{F'}) \times \mathbb{D}^{2b'} \xrightarrow{(\psi, \text{Id})} (X_R \cap W_F) \times \mathbb{D}^{2b'} \xrightarrow{\psi^{-1}} W_F$$

can be extended to a (trivial) invariant tubular neighborhood

$$\nu' : X_{R'} \times \mathbb{D}^{2b'} \longrightarrow W_{R'} \subset X_{\Delta}$$

since $\psi^{-1} \circ \nu$ maps $X_R \cap W_F$ onto $X_{R'} \cap W_{F'}$. Finally, set $\nu_S \equiv \nu \cup_{\psi} \nu'$. Then ν_S maps

$$(X_R \setminus W_F) \times \mathbb{D}^{2b'} \cup_{(\psi, \text{Id})} (X_{R'} \setminus W_{F'}) \times \mathbb{D}^{2b'} = Y_S \times \mathbb{D}^{2b'}$$

to $W_R \setminus W_F \cup_{\psi} W_{R'} \setminus W_{F'}$, that is, ν_S is a trivial invariant tubular neighborhood of Y_S .

Assume that Y_S is equivariantly diffeomorphic to some $\mathbb{S}^{2a'-1} \times (\mathbb{S}^1)^{p'}$. Then we may perform an elementary surgery corresponding to this choice of Y_S . In particular, we may perform an elementary surgery corresponding to any choice of a flip of Q , as soon as the corresponding invariant submanifold of Y is equivariantly diffeomorphic to some $\mathbb{S}^{2a'-1} \times (\mathbb{S}^1)^{p'}$. In this case, we say that the flip is *good*.

We may then repeat this process and construct manifolds obtained from a link by a finite number of elementary surgeries corresponding to good flips of the associate polytope.

Nevertheless, *it is not clear a priori that Y as well as the manifolds obtained from Y are equivariantly diffeomorphic to a link, that is to a transverse intersection of special real quadrics.*

Definition 3.4. We call *pseudolink* a manifold obtained from a link by a finite number of elementary surgeries corresponding to good flips of the associate polytopes.

We will see now that every flip is good.

Proposition 3.5. *Let X be a pseudolink such that its associate polytope P is a d -simplex. Then X is, up to product by circles, equivariantly diffeomorphic to the unit euclidean sphere \mathbb{S}^{2d+1} of \mathbb{C}^{d+1} endowed with the natural action of $(\mathbb{S}^1)^{d+1}$ on it.*

Proof. The proof is by induction on d . If $d = 0$, then X is obviously a product of circles and the Proposition is satisfied.

Assume now that the Proposition is true for simplices of dimension at most d and consider X a pseudolink whose associate polytope P is a $(d+1)$ -simplex. Then P can be seen as a pyramid with base a d -simplex P' and can be decomposed into a closed neighborhood of P' glued along the common boundary with a closed neighborhood of a 0-simplex v (a point). This means that X is equivariantly diffeomorphic to the gluing of an invariant closed neighborhood of $X'_{P'}$ with an invariant closed neighborhood of X_v by the identity along the common boundary. We may assume that these neighborhoods are tubular and thus trivial. Using the induction hypothesis and standard product neighborhoods, we may write

$$X \underset{eq}{\sim} \mathbb{S}^{2d+1} \times (\mathbb{S}^1)^p \times \overline{\mathbb{D}^2} \cup_{\phi} \overline{\mathbb{D}^{2b}} \times (\mathbb{S}^1)^p \times \mathbb{S}^1$$

for some $p \geq 0$ and some equivariant diffeomorphism ϕ of $\mathbb{S}^{2d+1} \times (\mathbb{S}^1)^{p+1}$. Using Lemma 3.3, we may assume that ϕ is the identity. Therefore, X is, up to product by circles, equivariantly diffeomorphic to the unit euclidean sphere \mathbb{S}^{2d+3} of \mathbb{C}^{d+2} endowed with the natural action of $(\mathbb{S}^1)^{d+2}$ on it. \square

Corollary 3.6. *Every flip of the associate polytope of a pseudolink is good.*

We finish this Section with a Proposition which will be useful in the sequel.

Proposition 3.7. *Let $A \in \mathcal{A}_k$ and $B \in \mathcal{A}_l$. Assume that X_B is obtained from X_A by performing an elementary surgery of type (a, b) corresponding to a flip. Then,*

- (i) *If $1 < a < n$ or $a = b = 1$, then $k = l$.*
- (ii) *If $a = 1$ and $b \neq 1$, then $k = l + 1$.*
- (iii) *If $a = n$ and $a \neq 1$, then $k = l - 1$.*

Proof. As the links X_A and X_B have same dimension, as well as P_A and P_B , the numbers n and p are the same for both links. This implies that k (respectively l) is equal to n minus the number of facets of P_A (respectively P_B) (see Lemma 0.11). Now, the results follow easily from the fact that a flip of type (a, b) does not create nor destroy any facet if $1 < a < n$ or $a = b = 1$ (see the figure in the proof of Proposition 2.13), creates a facet if $a = 1$ and $b \neq 1$ and destroys a facet if $a = n$ and $a \neq 1$ (see Proposition 2.9). \square

4. The Rigidity Theorem

We are now in position to prove:

Rigidity Theorem 4.1.

- (i) *Every pseudolink is a link.*
- (ii) *Let $A \in \mathcal{A}_k$ and $B \in \mathcal{A}_k$ for some k . Then $X_A \underset{eq}{\sim} X_B$ if and only if $P_A = P_B$.*

Remark 4.2. Let F_0 denote the product of complex projective lines $\mathbb{P}^1 \times \mathbb{P}^1$ and let F_1 denote the Hirzebruch surface obtained by adding a section at the infinite

to the line bundle of Chern class 1 over \mathbb{P}^1 . Both are projective toric varieties and thus admit a smooth, hamiltonian action of $(\mathbb{S}^1)^2$ with quotient space a convex polygon. In both cases, the polygon is a 4-gon (see [Fu]), so the two quotient spaces are combinatorially equivalent as convex polygons. Nevertheless, the two manifolds are not even topologically the same (see [M-K]): F_0 is diffeomorphic to a product $\mathbb{S}^2 \times \mathbb{S}^2$, whereas F_1 is the only non-trivial \mathbb{S}^2 -bundle over \mathbb{S}^2 . This example shows that the Rigidity result stated above is not obvious at all and is very particular to our situation.

Remark 4.3. Let $p = 0$ and $n \geq 2$. Then, X_A is the unit euclidean sphere \mathbb{S}^{2n-1} of \mathbb{C}^n . We may perform an equivariant surgery as follows:

$$\begin{aligned} & (X_A \setminus \mathbb{S}^1 \times \mathbb{D}^{2n-2}) \cup (\overline{\mathbb{D}^2} \times \mathbb{S}^{2n-3}) \\ &= (\overline{\mathbb{D}^2} \times \mathbb{S}^{2n-3}) \cup (\overline{\mathbb{D}^2} \times \mathbb{S}^{2n-3}) = \mathbb{S}^2 \times \mathbb{S}^{2n-3} \end{aligned}$$

This surgery looks like an elementary surgery of type $(1, n)$. In particular, it is easy to check that the quotient space of $\mathbb{S}^2 \times \mathbb{S}^{2n-1}$ by the induced torus action can be identified with the prism with base a $(n-2)$ -simplex, that is the simple convex polytope obtained from the $(n-1)$ -simplex P_A by a flip of type $(1, n)$. Nevertheless, this is not an elementary surgery by Definition 3.1 (X_A is simply-connected) and the resulting manifold is not a link by Rigidity Theorem 4.1 but a quotient of a link by an action of \mathbb{S}^1 . The simply-connected link corresponding to the prism with base a $(n-2)$ -simplex is

$$\begin{aligned} & (\mathbb{S}^{2n-1} \setminus \mathbb{S}^1 \times \mathbb{D}^{2n-2}) \times \mathbb{S}^1 \cup (\mathbb{S}^1 \times \mathbb{S}^{2n-3}) \times \overline{\mathbb{D}^2} \\ &= (\overline{\mathbb{D}^2} \times \mathbb{S}^1) \times \mathbb{S}^{2n-3} \cup (\mathbb{S}^1 \times \overline{\mathbb{D}^2}) \times \mathbb{S}^{2n-3} = \mathbb{S}^3 \times \mathbb{S}^{2n-3} \end{aligned}$$

Proof. Let P be a convex simple polytope. Call *length* of P the minimal number of flips necessary to pass from the simplex (of same dimension as P) to P . This number exists by Lemma 2.3.

The proof is by induction on the length of the associate polytope. More precisely, the induction hypothesis (at order l) is that statements (i) and (ii) are true for links and pseudolinks with associate polytopes of length less than or equal to l . This hypothesis is satisfied at order 0 by Propositions 1.2 and 3.5.

Assume the hypothesis at order l , and consider X a pseudolink with associate polytope P of length $l+1$. Then, if P undergoes some well-chosen flip, we obtain a simple convex polytope Q with length l . As usually, let (a, b) denote the type of the flip and F the simplicial face along which the flip is made. Remark that this implies that P is obtained from Q by performing a flip of type (b, a) along some simplicial face F' . Perform an elementary surgery of type (a, b) along the submanifold of X corresponding to F . We recover a pseudolink Y whose associate polytope is Q . By induction, Y is a link X_A for A belonging to some \mathcal{A}_k .

Define k' as k if $1 < a < n$ or $a = b = 1$, as $k+1$ if $a = 1$ and $b \neq 1$, and as $k-1$ otherwise. In this last case, notice that $k-1$ is positive: X is obtained from X_A by an elementary surgery of type $(1, n)$, so, by Definition 3.1, the link X_A is simply-connected. By Realization Theorem 0.13, there exists $B \in \mathcal{A}_{k'}$ such that P_B is combinatorially equivalent to P . Perform an elementary surgery of type (a, b) along the submanifold of X_B corresponding to F . By induction, the

result of this surgery is a link $X_{A'}$. Due to the choice of k' , we have $A' \in \mathcal{A}_k$ by Proposition 3.7. Therefore, the second statement of the induction hypothesis implies that $X_{A'} \underset{eq}{\sim} X_A$.

The conclusion of what precedes is that both X_B and X are obtained from the same link $X_{A'} \underset{eq}{\sim} X_A$ by performing an elementary surgery of type (b, a) along the same invariant submanifold (the submanifold corresponding to F' in Q). Therefore, X_B and X are equivariantly diffeomorphic and X is a link. This proves the first statement for associate polytopes of length $l+1$. Moreover, if you consider now any link X_C with $P_C = P$ and $C \in \mathcal{A}_{k'}$, then the same proof implies that $X_B \underset{eq}{\sim} X_C$. As these considerations do not depend on the value of k' , this proves one implication of statement (ii). But the converse is easy: two equivariantly diffeomorphic links have the same combinatorics of orbits, that is have combinatorially equivalent associate polytopes. The induction hypothesis is valid for length $l+1$. This finishes the proof. \square

Corollary 4.4. *Let $A \in \mathcal{A}_k$ and $B \in \mathcal{A}_0$. Then $X_A \underset{eq}{\sim} X_B \times (\mathbb{S}^1)^k$ if and only if $P_A = P_B$.*

Proof. By Lemma 0.9, there exists $A' \in \mathcal{A}_0$ such that the link X_A is equivariantly diffeomorphic to $X_{A'} \times (\mathbb{S}^1)^k$. In particular, this implies that $P_{A'} = P_A$. Now apply Rigidity Theorem 4.1. \square

Corollary 4.5. *Let $\Phi : [0, 1] \rightarrow \mathcal{A} \cap M_{np}(\mathbb{R})$ be a continuous path of admissible matrices of same dimensions. Set $A_t = \Phi(t)$. Then X_{A_0} is equivariantly diffeomorphic to X_{A_1} .*

Proof. Let $I \subset \{1, \dots, n\}$ such that 0 belongs to the convex hull of $((A_0)_i)_{i \in I}$. Then 0 belongs to the convex hull of $((A_t)_i)_{i \in I}$ for all t , otherwise there would be a time t_0 at which the weak hyperbolicity condition would be broken and the path Φ would not be a path of admissible matrices. As a consequence of Lemma 0.12 and (12), the associate polytopes K_{A_t} have all the same combinatorial type. Moreover this implies that all the X_{A_t} belong to the same \mathcal{A}_k . We may thus conclude from Rigidity Theorem 4.1 that X_{A_0} and X_{A_1} are equivariantly diffeomorphic. \square

Corollary 4.6. *Let $A \in \mathcal{A}$ and $B \in \mathcal{A}$ and $C \in \mathcal{A}$. Then $X_C \underset{eq}{\sim} X_A \times X_B$ (up to product by circles) if and only if $P_C = P_A \times P_B$.*

Proof. It is an immediate consequence of Example 0.6 and Rigidity Theorem 4.1, noting that, in Example 0.6, we have $P_C = P_A \times P_B$. \square

The second statement of the Rigidity Theorem 4.1 is definitely false if we replace equivariant diffeomorphism by diffeomorphism. A counterexample is given in [LdM2], p.242. We will see other interesting counterexamples in Section 6 (see Example 6.2).

We may now rely the two previous Sections in the following Theorem. As a direct consequence of the description of flips given in Section 2, of the description of elementary surgeries given in Section 3 and of Rigidity Theorem 4.1, we have

Theorem 4.7. *Let $A \in \mathcal{A}$ and let $B \in \mathcal{A}$ with same dimensions n and p . Assume that P_B is obtained from P_A by performing a flip of type (a, b) along some simplicial*

face F . Then, X_B is obtained (up to equivariant diffeomorphism) from X_A by performing an elementary surgery of type (a, b) along some X_F .

As noted above, the converse of the Theorem is false. Indeed, in Examples 2.10, 2.11 and 2.12, we may perform elementary surgeries which will not correspond to flips. In other words, the class of links (up to equivariant diffeomorphism) is not stable under elementary surgeries.

Corollary 4.8. *Let $A \in \mathcal{A}$. Then X_A is obtained (up to equivariant diffeomorphism) from $\mathbb{S}^{2n-2p-1} \times (\mathbb{S}^1)^p$ by performing a finite number of elementary surgeries.*

Proof. Let W be the simple polytope obtained from the product $P_A \times [0, 1]$ by cutting off a neighborhood of a vertex of $P_A \times \{1\}$ by a hyperplane (cf Lemma 2.3). Then W is a cobordism between P_A and the simplex of dimension $n - p - 1$. If it is trivial, then P_A is the $(n - p - 1)$ -simplex, otherwise it can be decomposed into a finite number of elementary cobordisms. Now apply Theorem 4.7 for each elementary cobordism and conclude in both cases with Corollary 1.4. \square

Corollary 4.9. *Let $A \in \mathcal{A}$ and let $B \in \mathcal{A}$ with same dimensions. Assume that X_B is obtained from X_A by an elementary surgery. Then there exists an equivariant cobordism between $X_A \times (\mathbb{S}^1)^2$ and $X_B \times (\mathbb{S}^1)^2$.*

Proof. Let $k \in \mathbb{N}$ such that $A \in \mathcal{A}_k$. Let (a, b) be the type of the elementary surgery transforming X_A into X_B . Let W be the corresponding elementary cobordism between P_A and P_B . We define an integer l as follows: if $a = 1$, then $k > 0$ by Definition 3.1 and we take $l = k - 1$; otherwise $l = k$. By use of the Realization Theorem 0.13, there exists a link X_C such that $P_C = W$ and $C \in \mathcal{A}_l$. By Lemma 0.11 and Proposition 2.13, we know that P_C has $n - l + 2$ facets. As it has dimension $n - p$, then C is a configuration of $n + 2$ points in \mathbb{R}^{p+1} , so X_C has dimension $2n - p + 2$. Using the fact that P_A and P_B are disjoint facets of P_C and that X_A and X_B have dimension $2n - p - 1$, we may embed by Proposition 1.1 the link $X_A \times \mathbb{S}^1$ (respectively $X_B \times \mathbb{S}^1$) as a smooth submanifold of X_C of codimension 2 with trivial normal bundle. The manifold obtained from X_C by removing an open trivial tubular neighborhood of each of these submanifolds is an equivariant cobordism between $X_A \times (\mathbb{S}^1)^2$ and $X_B \times (\mathbb{S}^1)^2$. \square

5. Wall-crossing

We will now use the previous results to resolve the wall-crossing problem (compare with [Bo], §4). Let us start with an example to make the next explanations clearer.

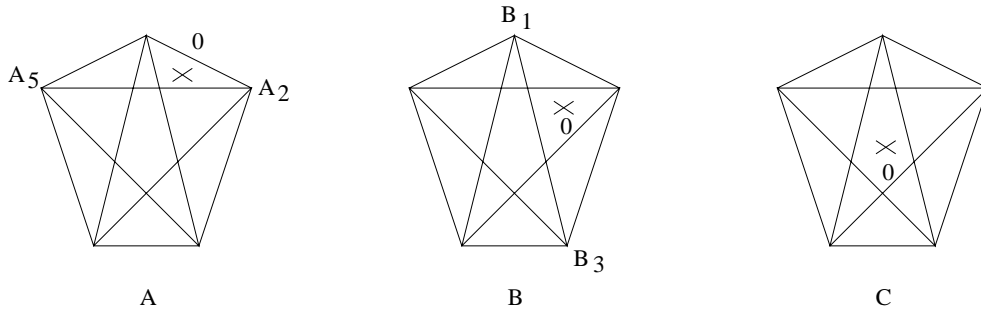

Example 5.1. Consider the links related to the three admissible configurations represented in the previous picture (the vertices of each configuration are numbered clockwise).

Here n is equal to 5 and p to 2. Note that B and C are translations of A in \mathbb{R}^2 . Nevertheless, the corresponding links are very different. From [LdM1] (see Example 0.5) or [McG], we can conclude that

$$\begin{aligned} X_A &\underset{eq}{\sim} \mathbb{S}^5 \times \mathbb{S}^1 \times \mathbb{S}^1 \\ X_B &\underset{eq}{\sim} \mathbb{S}^3 \times \mathbb{S}^3 \times \mathbb{S}^1 \\ X_C &\underset{eq}{\sim} \#(5)\mathbb{S}^3 \times \mathbb{S}^4 \end{aligned}$$

where $\#(5)\mathbb{S}^3 \times \mathbb{S}^4$ denotes the connected sum of five copies of $\mathbb{S}^3 \times \mathbb{S}^4$. By Corollary 4.5, as long as we move smoothly the configuration A without breaking the weak hyperbolic condition, i.e. *without crossing a wall*, the link X_A remains unchanged. But to go from A to B we have to cross the wall A_2A_5 , and to go from B to C we have to cross the wall B_1B_3 ; finally notice that we cannot pass directly from A to C with a single wall-crossing. The best we can do is to perform two wall-crossings.

Definition 5.2. Let $A \in \mathcal{A}$. A *wall* of A is an hyperplane of \mathbb{R}^p passing through p vectors of A and no more than p (the data of the hyperplane is thus equivalent to the data of the p vectors) and which does not support a facet of $\mathcal{H}(A)$.

From the definition, the intersection of the set $\{A_1, \dots, A_n\}$ with each open half-space defined by the wall is not vacuous.

Definition 5.3. Let $A \in \mathcal{A}$ and $B \in \mathcal{A}$ of same dimensions n and p . Let W be a wall of A . We say that B is obtained from A by *crossing the wall* W if

- (i) The configuration B is a translate of A by some vector v of \mathbb{R}^p .
- (ii) The configuration $A + tv$ is admissible for every t in $[0, 1]$ *except for one value* $t_0 \in]0, 1[$.
- (iii) At t_0 , the point $0 \in \mathbb{R}^p$ belongs to the translate of W by t_0v and does not belong to any other wall.

In other words, 0 “moves” continuously in the direction $-v$ and crosses the wall W , hence the terminology.

Let $A \in \mathcal{A}$ and let W be a wall of A . Then W parts \mathbb{R}^p into two open half-spaces containing the $n-p$ vectors of A not belonging to W . More precisely, one of the two open half-spaces, let us denote it by W^+ , contains 0 and a vectors of A , whereas the other (that we call W^-) contains b vectors of A . We say that the wall W is of *type* (a, b) . We have $a + b = n - p$ and $1 \leq a \leq n - p - 1$ and $1 \leq b \leq n - p - 1$.

Now, let B be obtained from A by crossing W . If, by abuse of notations, we still call W^+ and W^- the open half-spaces of \mathbb{R}^p separated by the translate of W , then W^+ still contains a vectors of B (which are exactly the translates of the a vectors of A lying in W^+) and W^- contains b vectors of B , but now 0 lies in W^- . In particular, before the wall-crossing, 0 belongs to the convex hull of the set consisting of the p vectors of the wall W and any vector of W^+ ; after crossing the wall, 0 belongs to the convex hull of the set consisting of the p vectors of the wall W and any vector of W^- .

Wall-crossing Theorem 5.4. *Let $A \in \mathcal{A}$ and $B \in \mathcal{A}$ of same dimensions n and p . Assume that $p > 0$. Then, the following propositions are equivalent:*

- (i) *The convex polytope P_B is obtained from P_A by a flip of type (a, b) along the simplicial face F_J .*
- (ii) *There exists $X_{B'} \underset{eq}{\sim} X_B$ and $X_{A'} \underset{eq}{\sim} X_A$ such that $X_{B'}$ is obtained from $X_{A'}$ by a single wall-crossing of A' , which is of type (a, b) .*

In the particular case where $p = 0$, the notion of wall is meaningless. This explains the restriction $p > 0$ in the statement of Wall-crossing Theorem 5.4.

Combining this result with Theorem 4.7 yields immediately

Corollary 5.5. *Under the same hypotheses, X_B is obtained from X_A by an elementary surgery of type (a, b) along X_{F_J} .*

In other words, the class of links (up to equivariant diffeomorphism) is not stable under elementary surgeries but is *stable under elementary surgeries coming from wall-crossings*.

Proof of Wall-crossing Theorem 5.4. The argument is purely convex. Assume (i). Then we can form the simple convex polytope P_C with P_A and P_B as separated facets and with one single extra vertex of index (a, b) . Let $k \in \mathbb{N}$ such that $A \in \mathcal{A}_k$. We define an integer l as in the proof of Corollary 4.9: if $a = 1$, then $k > 0$ (the assumption $p > 0$ excludes the case $a = b = 1$) and we take $l = k - 1$; otherwise $l = k$. Note that P_C has dimension $n - p$ and has $n + 2 - l$ facets by Proposition 2.13. By Realization Theorem 0.13, there exists a link X_C corresponding to P_C with $C \in \mathcal{A}_l$. We know that C is a configuration of $n + 2$ vectors of \mathbb{R}^{p+1} . We set $C = (C_0, \dots, C_{n+1})$. We may assume that $C_+ = C \setminus \{C_0\}$ satisfies $X_{C_+} \underset{eq}{\sim} X_A \times \mathbb{S}^1$ and that $C_- = C \setminus \{C_{n+1}\}$ satisfies $X_{C_-} \underset{eq}{\sim} X_B \times \mathbb{S}^1$ (see Corollary 4.9). Moreover, as $P_A \cap P_B$ is vacuous (as a face of P_C), then $C \setminus \{C_0, C_{n+1}\}$ is not admissible. We say that $\{C_0, C_{n+1}\}$ is *indispensable*. In particular, this means that there exists an hyperplane of \mathbb{R}^{p+1} passing through 0 strictly separating $\{C_0, C_{n+1}\}$ from $\overline{C} = C \setminus \{C_0, C_{n+1}\}$. Scaling each vector of \overline{C} by a strictly positive real number if necessary, we may assume that \overline{C} lies in an affine hyperplane H of \mathbb{R}^{p+1} without changing the equivariant diffeomorphism type of X_C (see Corollary 4.5).

Under this assumption, the convex hull of C_+ is a pyramid with base \overline{C} and apex C_{n+1} and containing 0. In particular, C_{n+1} is indispensable. This implies that, if we project 0 onto the hyperplane H by letting

$$\bar{0} = H \cap (0C_{n+1})$$

where $(0C_{n+1})$ denotes the line passing through the origin and through the point C_{n+1} ; then, identifying H with \mathbb{R}^p and $\bar{0}$ with the zero of \mathbb{R}^p yields an admissible configuration A' of n vectors in \mathbb{R}^p satisfying $X_{A'} \underset{eq}{\sim} X_A$ (cf Lemma 0.9).

Performing the same transformation on the convex hull of C_- viewed as a cone over \overline{C} with apex C_0 , we obtain an admissible configuration B' of n vectors in \mathbb{R}^p satisfying $X_{B'} \underset{eq}{\sim} X_B$ and such that B' is obtained from A' by translation.

The picture below should illustrate this construction. Taking $\bar{0}$ as O_1 (respectively O_2) gives the configuration A' (respectively B').

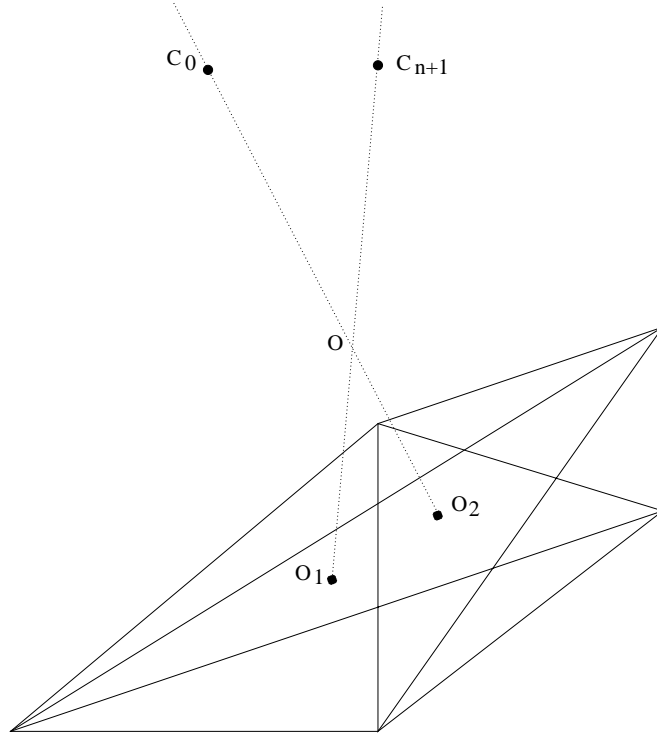

From the construction, there is a translation sending the configuration A' to B' . Let us now prove that this translation induces exactly one wall-crossing and characterize it.

Lemma 5.6. *Let $I \subset \{1, \dots, n\}$ of cardinal p . Assume that $\{(A'_i)_{i \in I}\}$ defines a wall W of A' . Then W is crossed when changing from A' to B' if and only if 0 is in the convex hull of $\{C_0, C_{n+1}\} \cup \{(C_i)_{i \in I}\}$.*

Proof of Lemma 5.6. The proof is direct. Let W be a wall of A' defined by I . The hyperplane passing through W and through 0 , let us call it H_1 , separates \mathbb{R}^{p+1} into two open half-spaces. Clearly, W is crossed when changing from A' to B' if and only if C_0 and C_{n+1} does not belong to the same open half-space. If it is the case, then H_1 cuts the segment $[C_0, C_{n+1}]$ in one point C_{t_0} and 0 belongs to the convex hull of $\{C_{t_0}\} \cup \{(C_i)_{i \in I}\}$. Therefore, 0 is in Δ , the convex hull of $\{C_0, C_{n+1}\} \cup \{(C_i)_{i \in I}\}$.

Conversely, assume that C_0 and C_{n+1} belongs to the same open half-space defined by H_1 . Then, the intersection of Δ and H_1 is included in W . Thus, it does not contain 0 . \square

Now, by Lemma 0.12 and by (12), a set of $p + 2$ vertices of C including C_0 and C_{n+1} and containing 0 in its convex hull corresponds to a vertex of P_C which neither belongs to P_A nor to P_B . As the flip transforming P_A into P_B is elementary, there exists only one such simplex, and thus B' is obtained from A' by a single wall-crossing along the wall W_J corresponding to the extra vertex of P_C . Let us determine the type of the wall.

Let I be the set of indices defining W . As before, let W^+ (respectively W^-) be the open half-space containing $\bar{0}$ (respectively not containing $\bar{0}$) before performing the wall-crossing. A point A'_i belongs to W^+ if and only if the convex hull of $\{A'_i\} \cup$

$\{A'_j \mid j \in I\}$ in \mathbb{R}^p contains $\bar{0}$. Since 0 belongs to the segment $[\bar{0}, C_{n+1}]$, this is the case if and only if the convex hull of $\{C_{n+1}\} \cup \{C_i\} \cup \{C_j \mid j \in I\}$ contains 0 in \mathbb{R}^{p+1} . Through (12), this determines a vertex v of $P_A \subset P_C$. Moreover, since 0 belongs to $\{C_0, C_{n+1}\} \cup \{C_j \mid j \in I\}$ by Lemma 5.6 and to $\{C_0, C_{n+1}\} \cup \{C_i\} \cup \{C_j \mid j \in I\}$, we know, still by (12), that there is an edge from v to the extra vertex of P_C (that is the vertex of $P_C \setminus (P_A \sqcup P_B)$). As this vertex has index (a, b) , the wall W separates A' into a vectors belonging to W^+ and b vectors belonging to W^- .

Conversely, assume (ii). Let us define a new admissible configuration as follows: let

$$1 \leq i \leq n \quad C_i = \begin{pmatrix} A'_i \\ -1 \end{pmatrix} \in \mathbb{R}^{p+1}$$

and let $\bar{0} = (0, -1) \in \mathbb{R}^p \times \mathbb{R}$. Consider the hyperplane $H = \mathbb{R}^p \times \{1\} \subset \mathbb{R}^{p+1}$. Let C_0 be the intersection of H with the line $(0\bar{0})$. We may now move $\bar{0}$ inside $\mathbb{R}^p \times \{-1\}$ *without moving the points C_i* to realize the wall-crossing from A' to B' . Define C_{n+1} as the intersection of H with $0\bar{0}$ after the translation of $\bar{0}$. Then C is obviously an admissible configuration. We obtain exactly the same picture as before.

Moreover, $C \setminus \{C_{n+1}\}$ is an admissible configuration which is a pyramid with base $\bar{C} = (C_1, \dots, C_n)$ and apex C_0 , thus

$$X_{C \setminus \{C_{n+1}\}} = X_C \cap \{z_{n+1} = 0\} \underset{eq}{\sim} X_{A'} \times \mathbb{S}^1$$

In the same way,

$$X_{C \setminus \{C_0\}} = X_C \cap \{z_0 = 0\} \underset{eq}{\sim} X_{B'} \times \mathbb{S}^1$$

From the construction, we obviously have $X_{\bar{C}} = \emptyset$. Therefore P_C is a cobordism between $P_{A'}$ and $P_{B'}$. But as above, using Lemmas 0.12 and 5.6 and (12), it is straightforward to check that P_C has a single extra vertex which is of index (a, b) and that P_C is an elementary cobordism between P_A and P_B along some simplicial face F_J . \square

Corollary 5.7. *Let $A \in \mathcal{A}$. Then there exists $A' \in \mathcal{A}$ such that*

- (i) *The link X_A is equivariantly diffeomorphic to $X_{A'}$.*
- (ii) *The configuration A' is obtained by wall-crossings from a configuration A'' satisfying $X_{A''} \underset{eq}{\sim} \mathbb{S}^{2n-2p-1} \times (\mathbb{S}^1)^p$.*

Proof. Let A' be a generic perturbation of A , that is a small perturbation of A whose convex hull is simplicial. In this situation, an hyperplane of \mathbb{R}^p contains at most p vertices of A' . By Corollary 4.5, we may assume that $X_{A'} \underset{eq}{\sim} X_A$. For simplicity, assume that the convex hull of (A'_1, \dots, A'_p) is a facet of $\mathcal{H}(A'_1, \dots, A'_n)$. Consider the region \mathcal{R} of \mathbb{R}^p defined as follows: \mathcal{R} is the union of the simplices whose vertices are constituted by $p-1$ points among (A'_1, \dots, A'_p) and two points among (A'_{p+1}, \dots, A'_n) .

The shaded region on the picture below is an example of such a \mathcal{R} .

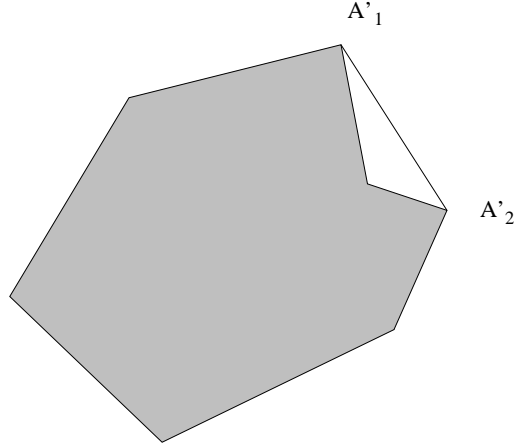

Notice that a point of $\mathcal{H}(A'_1, \dots, A'_n)$ which is sufficiently close to the center of $\mathcal{H}(A'_1, \dots, A'_p)$ does not belong to \mathcal{R} . Define A'' as an admissible configuration obtained as a translate of A' such that 0 does not belong to the corresponding translate of \mathcal{R} . In particular, A'' is obtained from A' by wall crossings. Then A''_1, \dots, A''_p are indispensable points of A'' , so by Lemma 0.9, we have that $A'' \in \mathcal{A}_k$ for $k \geq p$. This implies that $P_{A''}$ has dimension $n - p - 1$ and has at most $n - p$ facets. Therefore $k = p$ and P_A is the $(n - p - 1)$ -simplex, so by Corollary 1.4 we have $X_{A''} \underset{eq}{\sim} \mathbb{S}^{2n-2p-1} \times (\mathbb{S}^1)^p$. \square

Remark 5.8. Generically, we may take $A' = A$.

6. Elementary surgery of type $(1, n)$

Let X_A be a link. Assume that P_A is obtained from the simplex (of same dimension) by performing uniquely flips of type $(1, n)$. Then in this case, we may describe explicitly the diffeomorphism type of the link. First, note:

Lemma 6.1. *Let $A \in \mathcal{A}_k$ with $k > 1$. Let X_B be obtained from X_A by performing an elementary surgery of type $(1, n)$ along some invariant submanifold corresponding to a vertex. Then the diffeomorphism type of X_B is independent on the choice of the vertex on which the flip occurs.*

Proof. Let v and v' be two vertices of P_A . We want to prove that, if X_B and $X_{B'}$ denotes the links obtained from X_A by performing an elementary surgery of type $(1, n)$ along X_v (respectively $X_{v'}$), then these two links are diffeomorphic. It is enough to show this in the case where v and v' belong to the same edge E . Let us describe X_E . By Corollary 1.5, the link X_E is diffeomorphic to $\mathbb{S}^3 \times (\mathbb{S}^1)^p$. The real torus $(\mathbb{S}^1)^{p+2} = \mathbb{S}^1 \times \mathbb{S}^1 \times T$ acts on X_E in the following manner: decompose \mathbb{S}^3 as the union of two solid tori $(\mathbb{S}^1 \times \mathbb{D}^2) \times (\mathbb{D}^2 \times \mathbb{S}^1)$. Then $\mathbb{S}^1 \times \mathbb{S}^1$ acts on each solid torus in the natural way (that is the first factor by translations on \mathbb{S}^1 and the second factor tangentially to each circle on \mathbb{D}^2) and this describes the induced action on \mathbb{S}^3 ; finally, T acts by translations on $(\mathbb{S}^1)^p$. Therefore, X_v is exactly given as $(\mathbb{S}^1 \times \{0\}) \times (\mathbb{S}^1)^p$, that is as the core circle of the first solid torus product with $(\mathbb{S}^1)^p$; and $X_{v'}$ is exactly given as $(\{0\} \times \mathbb{S}^1) \times (\mathbb{S}^1)^p$, that is as the core circle of the second solid torus product with $(\mathbb{S}^1)^p$. There exists an isotopy in \mathbb{S}^3 which sends

$\mathbb{S}^1 \times \{0\}$ to $\{0\} \times \mathbb{S}^1$ and this isotopy can be extended by the identity on $(\mathbb{S}^1)^p$ to obtain an isotopy in X_E sending X_v to $X_{v'}$. Moreover, as it is the identity on $(\mathbb{S}^1)^p$, it maps the circle which will be filled by a 2-disk in the surgery giving X_B to the circle which will be filled by a 2-disk in the surgery giving $X_{B'}$. Therefore the two elementary surgeries give the same result that is, X_B is diffeomorphic to $X_{B'}$. \square

Of course, in the previous Lemma, the class of X_B modulo equivariant diffeomorphisms depends on the vertex on which the surgery occurs: generally, the corresponding flips give different combinatorial types so, by Rigidity Theorem 4.1, different equivariant smooth classes of links. Here is such an example.

Example 6.2. Consider the following polyhedron (the hexagonal book)

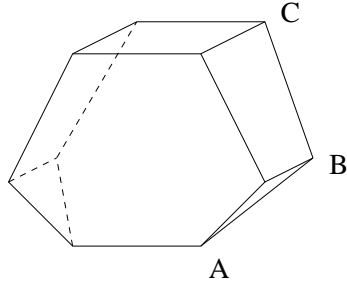

Let X_A be the corresponding link with $A \in \mathcal{A}_1$. Then, we may perform an elementary surgery of type $(1, 3)$ on X_A in three manners, corresponding to the three vertices A , B and C indicated on the picture. By Lemma 6.1, the resulting manifolds are all diffeomorphic but, by Rigidity Theorem 4.1, any two of them are not equivariantly diffeomorphic. In particular, this gives an example of a manifold which admits three different “structures of link”.

We may now describe explicitly the links corresponding to polytopes obtained from the simplex (of same dimension) by cutting off vertices.

Theorem 6.3 (see [McG]). *Let X_A be a simply-connected link such that P_A is obtained from the q -simplex (of same dimension) by l flips of type $(1, n)$ (we assume that $l > 0$). Then X_A is diffeomorphic to the following connected sum of products of spheres:*

$$X_A \simeq \#_{j=1}^l j \binom{l+1}{j+1} \mathbb{S}^{2+j} \times \mathbb{S}^{2q+l-j-1}$$

The proof of this Theorem is done for polygons in [McG] (Theorem 3.4) but the proof of this generalization is the same. Notice that this Theorem shows that, for any dimension of the associate polytope and for any value of p , there exist infinite families which are connected sums of products of spheres as in Example 0.5.

Going back to Example 6.2, we see that the manifold

$$\#(10)\mathbb{S}^3 \times \mathbb{S}^8 \#(20)\mathbb{S}^4 \times \mathbb{S}^7 \#(19)\mathbb{S}^5 \times \mathbb{S}^6$$

admits three different actions of $(\mathbb{S}^1)^8$ with quotient a convex polyhedron.

This Example can be easily generalized as follows.

Example 6.4. Consider the l -gonal book P_l for $l \geq 3$. It is obtained from the tetrahedron by $(l - 3)$ flips of type $(1, 3)$. By Theorem 6.3, it thus gives rise to a 2-connected link diffeomorphic to

$$X_l = \#_{j=1}^{l-3} j \binom{l-2}{j+1} \mathbb{S}^{2+j} \times \mathbb{S}^{2+l-j}$$

Consider a l -gonal facet of P_l . Number its vertices as indicated in the following picture.

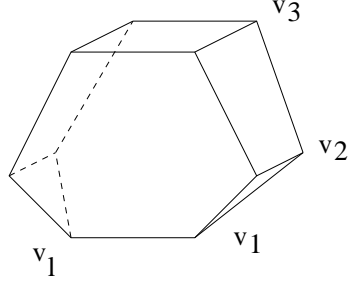

The simple convex polyhedra obtained from X_{l-1} by cutting off a vertex v_i are all combinatorially different when i ranges from 1 to $[l/2]$ (where $[-]$ denotes the integer part). One of these polyhedra being the l -gonal book, we have by Lemma 6.1 that the corresponding links are all diffeomorphic to X_l .

In other words, the manifold X_l admits at least $[l/2]$ structures of link. Therefore, the number of structures of link that X_l has tends to infinity when l tends to infinity. Notice that the dimension of X_l is $l + 4$.

PART II: THE COHOMOLOGY RING OF A LINK

Thanks to Theorems 0.13 and 4.1, there is exactly one 2-connected link (up to equivariant diffeomorphism) associated to any simple convex polytope (recall that we always consider a convex polytope only up to combinatorial equivalence). In this part, we give an explicit formula for the cohomology ring of a 2-connected link in terms of its associate polytope. We use this formula to show that the cohomology of a link can have arbitrary amount of torsion.

7. Notations and statement of the results

We denote by P a simple convex polytope and by X the associated 2-connected link, that is we drop the subscript A referring to the choice of a matrix.

Given a finite simplicial complex Γ , we make no distinction between Γ and the poset of faces of Γ ordered by inclusion. In particular, let E be a set and F a poset whose elements are subsets of E ordered by inclusion. If every nonempty subset J of $I \in F$ also belongs to F , then we consider F as a simplicial complex whose k -faces are the elements of F of cardinal $k + 1$.

Furthermore, we note:

- d the dimension of P ;
- n the number of facets of P ;
- ∂P the boundary of P . We consider it as a cell complex;
- P_b the barycentric subdivision of ∂P . In the same way, the barycentric subdivision of a simplicial complex Γ will be denoted Γ_b . If a set I numbers a simplex σ of Γ , then we number the center of σ in Γ_b by the same set I , that is we identify a simplex of Γ and its center in Γ_b ;
- \mathcal{F} the set of the facets of P ;
- \mathcal{I} a subset of \mathcal{F} ;
- $|\mathcal{I}|$ the cardinal of \mathcal{I} ;
- $\bar{\mathcal{I}}$ the complement of \mathcal{I} in \mathcal{F} ;
- $F_{\mathcal{I}}$ the intersection of the facets of P that are in \mathcal{I} . It is either empty or a face of P ;
- Δ the poset of nonempty subsets \mathcal{I} of \mathcal{F} such that $F_{\bar{\mathcal{I}}} = \emptyset$ ordered by inclusion. It is a simplicial complex;
- $P_{\mathcal{I}}$ the union of the facets of P that are in \mathcal{I} ;
- $K_{\mathcal{I}}$ the poset of nonempty subsets I of \mathcal{I} such that F_I is a (nonempty) face of P ordered by inclusion. It is a simplicial complex. We will often consider its barycentric subdivision $(K_{\mathcal{I}})_b$ as a simplicial subcomplex of P_b by identifying a subset I to the center of the face F_I in the barycentric subdivision of ∂P ;
- $\tilde{\mathcal{I}}$ the poset of proper subsets I of $\bar{\mathcal{I}}$ such that $F_{\bar{\mathcal{I}} \setminus I}$ is not empty ordered by reverse inclusion. It is also a simplicial complex;
- \hat{I} the complement of a subset I in $\bar{\mathcal{I}}$;
- P^* the dual polytope of P ;
- δ_i^j the Kronecker symbol;

- $H_i(A, \mathbb{Z})$ (respectively $\tilde{H}_i(A, \mathbb{Z})$) the i -th homology group (respectively reduced homology group) of a manifold or a simplicial complex A with coefficients in \mathbb{Z} . By convention, we set $\tilde{H}_{-1}(\emptyset, \mathbb{Z}) = \mathbb{Z}$;
- $H^i(A, \mathbb{Z})$ (respectively $\tilde{H}^i(A, \mathbb{Z})$) the i -th cohomology group (respectively reduced cohomology group) of a manifold or a simplicial complex A with coefficients in \mathbb{Z} ;
- the simplex whose vertices are the elements of a finite set E will be denoted Δ_E and its boundary S^E (in some context, Δ_E will be noted σ_E);

Definition 7.1. For a nonempty face F of P , the vector space underlying the affine space in which F has nonempty interior will be called the (vector) space of F . By abuse of notation, we will still denote by F the space of F . No confusion should arise from this abuse.

Definition 7.2. A proper face of P will be called an \mathcal{I} -face (respectively an $\bar{\mathcal{I}}$ -face) if every facet of P containing it is in \mathcal{I} (respectively in $\bar{\mathcal{I}}$).

We prove now some preliminary results on simple polytopes.

Lemma 7.3. Let P be a simple polytope and let $\mathcal{I} \subset \mathcal{F}$. Then, a nonempty intersection of elements of \mathcal{I} is an \mathcal{I} -face.

Proof. This comes directly from the fact that the neighborhood of a face in a simple polytope is the product of this face by a simplex. Hence, for every face F of P , there is a unique subset \mathcal{I} such that $F_{\mathcal{I}} = F$ and F is an \mathcal{I} -face. \square

This Lemma is false for non-simple polytopes. In the following picture, the polytope is a pyramid with rectangular base and apex v , whereas the set \mathcal{I} consists of two faces whose intersection is v . Nevertheless, v is not an \mathcal{I} -face.

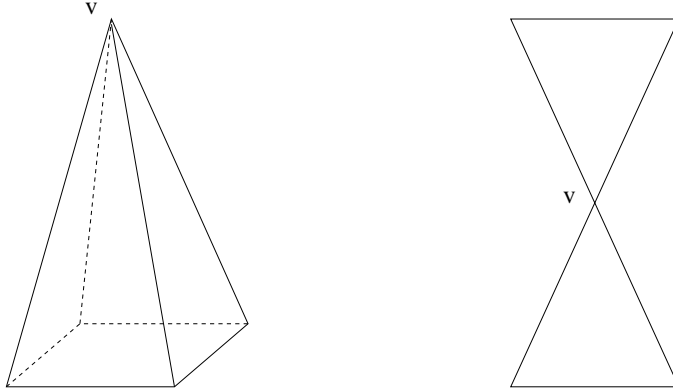

We then have

Lemma 7.4. Let P be a simple polytope. Consider a subset \mathcal{I} of \mathcal{F} . Then,

- The complex $(K_{\mathcal{I}})_b$ is homotopy equivalent to $P_{\mathcal{I}}$.
- The set $P_{\mathcal{I}}$ has the same homotopy type as its interior in ∂P .

Proof. The barycentric subdivision of ∂P is a simplicial complex whose vertices are all the (nonempty) faces of P . By Lemma 7.3, the complex $(K_{\mathcal{I}})_b$ is isomorphic to the subcomplex of this subdivision associated to \mathcal{I} -faces. Each point M of $P_{\mathcal{I}}$ belongs to a *unique* minimal simplex of P_b and this simplex has at least one vertex

belonging to $(K_{\mathcal{I}})_b$ (the center of the minimal face which contains it). Take the barycentric coordinates of M in this simplex. We may then construct a retraction of $P_{\mathcal{I}}$ on $(K_{\mathcal{I}})_b$ by cancelling the bad barycentric coordinates (i.e. coordinates associated to vertices which do not belong to $(K_{\mathcal{I}})_b$).

To prove (ii), just remark that the previous construction yields also a retraction of the interior of $P_{\mathcal{I}}$ onto $(K_{\mathcal{I}})_b$. \square

This Lemma is in fact a variation of the following well known fact:

Lemma 7.5. *Let Δ be a simplicial complex, Γ a subcomplex. Then the "mirror complex" of Γ in Δ , i.e. the complex of the faces of Δ_b that are disjoint from Γ_b is homotopy equivalent to (and even a deformation retract of) $\Delta \setminus \Gamma$.*

We may now state

Cohomology Theorem 7.6. *For any i , we have an isomorphism:*

$$H^i(X, \mathbb{Z}) \simeq \bigoplus_{\mathcal{I} \subset \mathcal{F}} \tilde{H}_{d+|\bar{\mathcal{I}}|-i-1}(P_{\mathcal{I}}, \mathbb{Z})$$

We note $\psi([c])$ the inverse image by this isomorphism of a class $[c]$ in any factor of the second member.

Moreover, consider two classes $[c] \in \tilde{H}_k(P_{\mathcal{I}}, \mathbb{Z})$ and $[c'] \in \tilde{H}_{k'}(P_{\mathcal{J}}, \mathbb{Z})$. Note $[c] \cap [c']$ their intersection class in $\tilde{H}_{k+k'-d+1}(P_{\mathcal{I} \cap \mathcal{J}}, \mathbb{Z})$. Then, up to sign, the cup product of their images by ψ is given by :

$$\psi([c]) \smile \psi([c']) = \begin{cases} \psi([c] \cap [c']) & \text{if } \mathcal{I} \cup \mathcal{J} = \mathcal{F} \\ 0 & \text{else} \end{cases}$$

Remark 7.7. The following formula for the homology groups of X in terms of P^* also holds:

$$\tilde{H}_i(X, \mathbb{Z}) \simeq \bigoplus_{\mathcal{I} \subset \mathcal{F}} \tilde{H}_{i-|\mathcal{I}|-1}(P_{\mathcal{I}}^*, \mathbb{Z})$$

where \mathcal{F} is identified with the set of vertices of P^* and where $P_{\mathcal{I}}^*$ denotes the maximal simplicial subcomplex of P^* with vertex set \mathcal{I} . In some cases, this formula is easier to use to compute the homology groups. We will prove this formula at the same time as the formula of Cohomology Theorem 7.6.

Remark 7.8. If \mathcal{I} and \mathcal{J} are complementary in \mathcal{F} and we take classes $[c] \in \tilde{H}_k(P_{\mathcal{I}}, \mathbb{Z})$ and $[c'] \in \tilde{H}_{k'}(P_{\mathcal{J}}, \mathbb{Z})$ with $k+k' = d-2$, then their intersection class in $\tilde{H}_{-1}(\emptyset, \mathbb{Z}) \simeq \mathbb{Z}$ is their linking number. In particular, *Poincaré duality on X is given by Alexander duality on ∂P .*

Example 7.9. Let P be the cube. Number its facets in the following way: 1, 2 and 3 denote three faces adjacent to a vertex v , whereas $1'$ (respectively $2'$, $3'$) is the opposite face to 1 (respectively 2, 3).

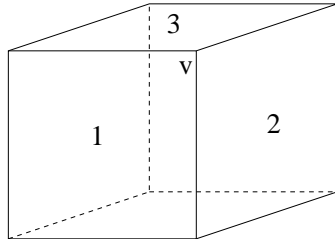

The sets $P_{\{1,2,1',2'\}}$, $P_{\{1,3,1',3'\}}$ and $P_{\{2,3,2',3'\}}$ have the homotopy type of a circle. Let us denote by $[c_{12}]$ (respectively $[c_{13}]$ and $[c_{23}]$) a generator of $\tilde{H}_1(P_{\{1,2,1',2'\}}, \mathbb{Z})$ (respectively $\tilde{H}_1(P_{\{1,3,1',3'\}}, \mathbb{Z})$ and $\tilde{H}_1(P_{\{2,3,2',3'\}}, \mathbb{Z})$).

The sets $P_{\{1,1'\}}$, $P_{\{2,2'\}}$ and $P_{\{3,3'\}}$ have the homotopy type of a pair of points. Let us denote by $[c_1]$ (respectively $[c_2]$ and $[c_3]$) a generator of $\tilde{H}_0(P_{\{1,1'\}}, \mathbb{Z})$ (respectively $\tilde{H}_0(P_{\{2,2'\}}, \mathbb{Z})$ and $\tilde{H}_0(P_{\{3,3'\}}, \mathbb{Z})$).

Finally, let us denote by $[c]$ a generator of the top-dimensional cohomology group of the associated link X .

Cohomology Theorem 7.6 gives the cohomology groups of X .

i	$\tilde{H}^i(X, \mathbb{Z}) \simeq$
1, 2, 4, 5, 7, 8	$\{0\}$
3	$\mathbb{Z} \cdot \psi([c_{12}]) \oplus \mathbb{Z} \cdot \psi([c_{13}]) \oplus \mathbb{Z} \cdot \psi([c_{23}])$
6	$\mathbb{Z} \cdot \psi([c_1]) \oplus \mathbb{Z} \cdot \psi([c_2]) \oplus \mathbb{Z} \cdot \psi([c_3])$
9	$\mathbb{Z} \cdot [c]$

and the only non-zero cup products are, up to sign,

$$\begin{aligned} \psi([c_{12}]) \smile \psi([c_3]) &= \psi([c_{13}]) \smile \psi([c_2]) = \psi([c_{23}]) \smile \psi([c_1]) = [c] \\ \psi([c_{12}]) \smile \psi([c_{13}]) &= \psi([c_1]) \\ \psi([c_{12}]) \smile \psi([c_{23}]) &= \psi([c_2]) \\ \psi([c_{13}]) \smile \psi([c_{23}]) &= \psi([c_3]) \end{aligned}$$

From Corollary 4.6 and Example 0.6, we know that X is a product of spheres $\mathbb{S}^3 \times \mathbb{S}^3 \times \mathbb{S}^3$. We recover here its cohomology ring.

Proof of the first part of Theorem 7.6 and of Remark 7.7. By Lemma 0.7, the link X has the same homotopy type as the complement \mathcal{S} of a coordinate subspace arrangement \mathcal{L} of \mathbb{C}^n (see (2) and (3); as for the case of X and P , we drop the subscript referring to a matrix A). Notice that \mathcal{L} is only defined up to a permutation of the coordinates of \mathbb{C}^n . Now, fix a numbering of the facets of P by integers from 1 to n . Then, by (11), this indeterminacy on \mathcal{L} is cancelled.

We make use of the formulas given in [DL] which describe the cohomology ring of a coordinate subspace arrangement. Let us first recall De Longueville's notations and results adapted to our case.

Let Δ be the simplicial complex defined at the beginning of this Section. Let (e_1, \dots, e_n) be the canonical basis of \mathbb{C}^n . We may associate to Δ the following coordinate subspace arrangement

$$(15) \quad \mathcal{A}_\Delta = \{\text{Vect}_{\mathbb{C}}(e_i)_{i \in \mathcal{I}} \mid \mathcal{I} \subset \Delta\}$$

Using (11), it is straightforward to check that

Lemma 7.10. *We have $\mathcal{A}_\Delta = \mathcal{L}$.*

Finally, let σ be a face of Δ ; we define

$$\text{link}_\Delta \sigma = \{\tau \in \Delta \mid \sigma \cap \tau = \emptyset, \sigma \cup \tau \in \Delta\}$$

Geometrically, $\text{link}_\Delta \sigma$ is the boundary of the subcomplex of Δ formed by the simplices to which σ belongs.

Remark 7.11. Let $\sigma_{\mathcal{I}}$ be a face of Δ indexed by $\mathcal{I} \subset \mathcal{F}$. Then, we have

$$\text{link}_\Delta \sigma_{\mathcal{I}} = \{I \subset \tilde{\mathcal{I}} \mid F_{\hat{I}} = F_{\tilde{\mathcal{I}} \setminus I} = \emptyset\}.$$

Therefore, the set $\tilde{\mathcal{I}}$ defined at the beginning of this Section is exactly the set of nonempty subsets of $\tilde{\mathcal{I}}$ which are not in $\text{link}_\Delta \sigma_{\mathcal{I}}$.

With these notations, the Goresky-Mac Pherson formula of [G-McP] states that the reduced cohomology group $\tilde{H}^i(\mathcal{S}, \mathbb{Z})$ is isomorphic to the sum of the groups $\tilde{H}_{2|\tilde{\mathcal{I}}|-i-2}(\text{link}_\Delta \sigma_{\mathcal{I}}, \mathbb{Z})$, the sum being taken over all the elements σ in Δ . As \mathcal{S} and X are homotopy equivalent, the same result is also true for X .

On the other hand, consider two elements σ_1 and σ_2 of the complex Δ and two classes $[c_1]$ and $[c_2]$ of $\tilde{H}_{2|\sigma|-i-2}(\text{link}_\Delta \sigma_1, \mathbb{Z})$ and $\tilde{H}_{2|\sigma|-i-2}(\text{link}_\Delta \sigma_2, \mathbb{Z})$ represented by c_1 and c_2 . Noting also $\psi([c])$ the cohomology class associated to some class $[c]$, De Longueville shows in [DL] that, up to sign:

$$\psi([c_1]) \smile \psi([c_2]) = \begin{cases} \psi([\langle i_2 - i_1 \rangle * c_1 * c_2]) & \text{if } \sigma_1 \cup \sigma_2 = \mathcal{F} \\ 0 & \text{else} \end{cases}$$

where i_1 and i_2 are elements out of σ_1 and σ_2 respectively, and where $*$ denotes the join of two cycles.

To prove the Theorem, we will establish isomorphisms between the groups which compose the cohomology of X , then study the behaviour of the product in the polytopal case.

Lemma 7.12. *For any \mathcal{I} , the group $\tilde{H}_{d+|\tilde{\mathcal{I}}|-i-1}(P_{\mathcal{I}}, \mathbb{Z})$ is*

- isomorphic to $\tilde{H}_{2|\tilde{\mathcal{I}}|-i-2}(\text{link}_\Delta \sigma_{\mathcal{I}}, \mathbb{Z})$ if \mathcal{I} is in Δ ;
- zero if \mathcal{I} is not in Δ and not \mathcal{F} ;
- zero if $\mathcal{I} = \mathcal{F}$ and $i \neq 0$;
- isomorphic to \mathbb{Z} if $\mathcal{I} = \mathcal{F}$ and $i = 0$.

Proof of Lemma 7.12. Let us begin with the simple special case: $\mathcal{I} = \mathcal{F}$. In this case, \mathcal{F} is not in Δ and $P_{\mathcal{I}}$ is all ∂P .

We then have $\tilde{H}_{d+|\tilde{\mathcal{I}}|-i-1}(P_{\mathcal{I}}, \mathbb{Z}) = \tilde{H}_{d-i-1}(\mathbb{S}^{d-1}, \mathbb{Z})$ which is zero, except if $d - i - 1 = d - 1$, i.e. $i = 0$ in which case this group is isomorphic to \mathbb{Z} .

Consider now that \mathcal{I} is not in Δ and not \mathcal{F} . Then the facets of $\tilde{\mathcal{I}}$ exist and intersect. The set $P_{\tilde{\mathcal{I}}}$ is therefore starshaped in ∂P and then so is $P_{\mathcal{I}}$ (∂P is considered as a sphere). Hence, $P_{\mathcal{I}}$ is contractible and all its reduced homology groups vanish.

We will establish that, in the other cases, $\text{link}_\Delta \sigma_{\mathcal{I}}$ and $P_{\mathcal{I}}$ have complements in some spheres that are homotopy equivalent. The isomorphism will follow from Alexander duality applied twice.

First, except in the special case thereup, $\text{link}_\Delta \sigma_{\mathcal{I}}$ is a subcomplex of $S^{\tilde{\mathcal{I}}}$, which is a sphere of dimension $n - |\mathcal{I}| - 2$. By Lemma 7.5, its complement in this sphere

is homotopy equivalent to its mirror complex. Here this mirror complex is the subcomplex of the barycentric subdivision of $S^{\tilde{\mathcal{I}}}$, whose vertices are the ones corresponding to elements of $\tilde{\mathcal{I}}$ (see Remark 7.11), i.e. is isomorphic to the simplicial complex $\tilde{\mathcal{I}}_b$. Hence, by Alexander duality, $\tilde{H}_{2|\tilde{\mathcal{I}}|-i-2}(\text{link}_{\Delta}\sigma_{\mathcal{I}}, \mathbb{Z})$ is isomorphic to $\tilde{H}^{i-|\tilde{\mathcal{I}}|-1}(\tilde{\mathcal{I}}_b, \mathbb{Z})$ and thus to $\tilde{H}^{i-|\tilde{\mathcal{I}}|-1}(\tilde{\mathcal{I}}, \mathbb{Z})$.

On the other side, $P_{\tilde{\mathcal{I}}}$ is the complement in ∂P of $P_{\tilde{\mathcal{I}}}$ (of its interior precisely but, by Lemma 7.4, they are homotopically equivalent). Still by Lemma 7.4, $P_{\tilde{\mathcal{I}}}$ is homotopically equivalent to $(K_{\tilde{\mathcal{I}}})_b$. Then, by Alexander duality, we get an isomorphism between $\tilde{H}^{i-|\tilde{\mathcal{I}}|-1}(K_{\tilde{\mathcal{I}}}, \mathbb{Z})$ and $\tilde{H}_{|\tilde{\mathcal{I}}|+d-i-1}(P_{\tilde{\mathcal{I}}}, \mathbb{Z})$.

But we claim that the complexes $\tilde{\mathcal{I}}$ and $K_{\tilde{\mathcal{I}}}$ are isomorphic. In fact, by definition of $\tilde{\mathcal{I}}$, the map $I \rightarrow \hat{I}$ sends $\tilde{\mathcal{I}}$ to the set of $\tilde{\mathcal{I}}$ -faces, reversing inclusion. \square

It is now easy to complete the proof of the first part of Theorem 7.6. Finally, noting that $P_{\tilde{\mathcal{I}}}^*$ is isomorphic to $K_{\tilde{\mathcal{I}}}$ for $\mathcal{I} \in \Delta$, we deduce from the proof of Lemma 7.12 that $\tilde{H}^{2|\tilde{\mathcal{I}}|-i-2}(\text{link}_{\Delta}\sigma_{\mathcal{I}}, \mathbb{Z})$ is isomorphic to $\tilde{H}_{i-|\tilde{\mathcal{I}}|-1}(P_{\tilde{\mathcal{I}}}^*, \mathbb{Z})$. This leads to the formula of Remark 7.7. \square

Notation 7.13. For a class $[c]$ in $\tilde{H}_k(\text{link}_{\Delta}\sigma_{\mathcal{I}}, \mathbb{Z})$, its image in $\tilde{H}_{k+|\tilde{\mathcal{I}}|+d+1}(P_{\mathcal{I}}, \mathbb{Z})$ by the forementioned isomorphism will be denoted $\phi([c])$.

In order to prove the second part of Theorem 7.6, we have to explicitly establish the correspondance between the groups. As we need to explicitly compute Alexander duals, we have to deal with orientations.

8. Orientation

We talk here about Alexander duality on spheres of the form $S^{\mathcal{I}}$ for subsets \mathcal{I} of \mathcal{F} and on the sphere ∂P . These spheres have then to be oriented (in fact, this is not really necessary as long as we work up to sign, but even then suitable choices a bit simplify matters). Let us start with the orientation of ∂P . We consider P as being realized in \mathbb{R}^d . We orient \mathbb{R}^d and thus obtain an orientation of P .

Orientation of a facet and of a boundary: recall that if we consider an oriented polytope, there is a canonical orientation of its boundary by stating that for any facet F of this polytope, a basis consisting of the normal outward pointing vector followed by a positively oriented basis of the space of the facet is a positively oriented basis of the space of the polytope.

Orientation of a face of P : consider a k -tuple (H_1, \dots, H_k) of facets of P with nonempty intersection. Then $F_{(H_1, \dots, H_k)}$ denote the intersection of these facets endowed with the following orientation: taking a basis $(v_1, \dots, v_k, \mathcal{B})$ of the space of P , where v_i denotes the normal outward pointing vector of H_i and \mathcal{B} is a basis of the space of our face, we state that both basis have the same orientation. Remark that even a 0-dimensional face has two "orientations".

Remark 8.1. To orient a face of P is equivalent to order the set of facets containing it. In particular, given an orientation of a convex polytope, *there is no canonical orientation of the faces which are not facets.*

Definition 8.2. A d -tuple (H_1, \dots, H_d) of facets of P with nonempty intersection will be called direct if (v_1, \dots, v_d) is a positively oriented basis. It will be called undirect else.

Notation 8.3. For a k -tuple $I = (H_1, \dots, H_k)$ and a k' -tuple $J = (H'_1, \dots, H'_{k'})$ disjoint from I of facets of P such that F_I and F_J have nonempty intersection, the face associated to the $(k + k')$ -tuple $(H_1, \dots, H_k, H'_1, \dots, H'_{k'})$ will be denoted F_{I+J} .

Orientation of an intersection: consider a n -dimensional oriented vector space E and two oriented subspaces F and F' , of respective strictly positive dimension d and d' and whose sum is E . Then the vector space $F \cap F'$ is oriented with the convention that if $\mathcal{B} = (v_1, \dots, v_{d+d'-n})$ is a basis of $F \cap F'$, if $(w_1, \dots, w_{n-d'}, v_1, \dots, v_{d+d'-n})$ is a positive basis of F and $(v_1, \dots, v_{d+d'-n}, w'_1, \dots, w'_{n-d})$ a positive basis of F' , then the basis \mathcal{B} of $F \cap F'$ and the basis $(w_1, \dots, w_{n-d'}, v_1, \dots, v_{d+d'-n}, w'_1, \dots, w'_{n-d})$ have the same sign. In the special case where $F \cap F'$ is reduced to $\{0\}$, then we state that $F \cap F'$ is positively oriented if $(w'_1, \dots, w'_{n-d}, w_1, \dots, w_{n-d'})$ is a positive basis of \mathbb{R}^d . This convention is taken to guarantee the statement of Lemma 8.5 (see below) in this special case.

Remark 8.4. With this definition, the orientations of $F \cap F'$ and $F' \cap F$ may be different.

The previous convention is a generalization of the convention of orientation of a face, since we have:

Lemma 8.5. *With the orientation conventions thereup, F_{I+J} is equal to $F_I \cap F_J$ as oriented face.*

Proof. We use Notation 8.3. Let v_i (respectively v'_i) denote the normal outward pointing vector of H_i (respectively H'_i). We may assume that F_I and F_J are orthogonal. Let \mathcal{B} be a basis of $F_I \cap F_J$. Then $(v_1, \dots, v_k, v'_1, \dots, v'_{k'}, \mathcal{B})$ is a positive basis of \mathbb{R}^d if and only if $(v'_1, \dots, v'_{k'}, \mathcal{B})$ is a positive basis of F_I whereas $(v'_1, \dots, v'_{k'}, \mathcal{B}, v_1, \dots, v_k)$ is a positive basis of \mathbb{R}^d if and only if $(\mathcal{B}, v_1, \dots, v_k)$ is a positive basis of F_J . The claim follows then easily. \square

Lemma 8.6. *Let P be an oriented polytope. Let F be a face of P . Fix an orientation of F . With the orientation conventions thereup, the oriented boundary of F is given by:*

$$\partial F = \sum_{H \in \mathcal{F}, F \cap H \neq F, \emptyset} F \cap H$$

where F is considered as an oriented polytope and H is endowed with the canonical orientation of ∂P .

Proof. We may find $I = (H_1, \dots, H_k)$ such that $F_I = F$ as oriented face. Now, set $\mathcal{F} = \{H_1, \dots, H_n\}$. For $k < i \leq n$, the oriented face $F_{I+\{i\}}$ is a facet of F_I (if non-empty) which is easily seen to be positively oriented with respect to the convention about the orientation of a facet. Therefore,

$$\partial F = \sum_{k < i \leq n} F_{I+\{i\}}$$

The result follows now from Lemma 8.5. \square

Now, we orient the spheres $S^{\mathcal{I}}$. We consider an order on \mathcal{F} and for any subset \mathcal{I} of \mathcal{F} we orient $\Delta_{\mathcal{I}}$ compatibly with the restriction to \mathcal{I} of the order on \mathcal{F} as explained below. Then, $S^{\mathcal{I}}$ is oriented as boundary of $\Delta_{\mathcal{I}}$.

Orientation of a simplex: consider a finite set E having at least two elements and a total order \leq . We can associate to this order an orientation of Δ_E by stating that if $e_0 \leq \dots \leq e_{|E|-1}$ are the ordered elements of E , then the basis $\overrightarrow{e_0 e_1}, \dots, \overrightarrow{e_0 e_{|E|-1}}$ is a positively oriented basis of the space of Δ_E . The order and the orientation are then called compatible.

Convention 8.7. In the sequel, a subset \mathcal{I} of \mathcal{F} will always be considered as an ordered set, with the order induced from the order of \mathcal{F} . In particular, the simplex $\sigma_{\mathcal{I}}$ is thus an oriented simplex.

Notation 8.8. Let E and F be disjoint finite sets with orders \leq_E on E and \leq_F on F . Then EF denotes the set $E \cup F$ endowed with the following order: any element of E is less than any element of F and the restriction of the order to E (respectively to F) is \leq_E (respectively \leq_F).

We finish this Section with another convention of orientation that will be needed.

Orientation of a join: consider two oriented simplices Δ_E and Δ_F on disjoint finite sets E and F , whose orientations are compatible with the orders \leq_E on E and \leq_F on F . We orient their join $\Delta_E * \Delta_F$ compatibly with the order on EF . We easily check that this orientation does not depend on the chosen orders. Indeed, we have $\Delta_E * \Delta_F = \Delta_{EF}$.

To sum up, *given a total order on \mathcal{F} , then, with the conventions thereup, an orientation is fixed on any face of P as well as on any sphere $S^{\mathcal{I}}$ for $\mathcal{I} \subset \mathcal{F}$.*

9. Alexander duals up to a sign

To compute Alexander duals, we make use of [Al], t. 3, ch. XIII. We first recall this construction in our context. Let P be an oriented simple convex polytope. Let K be ∂P seen as a cell complex. Let m be its dimension. Given an oriented cell σ of K , its star dual σ^* is defined as the maximal subcomplex of the barycentric subdivision K_b of K whose vertices are the centers of the faces of K containing σ (see [Al], t. 1, p.143–144). An orientation is fixed on σ^* by demanding that the intersection number of σ with σ^* is $+1$ ([Al], t. 3, p.11–17). We denote by K^* the complex of the star duals of the faces of K . It is an abstract simplicial complex whose k -simplices are the star duals of dimension k , that is the star duals of $(m-k)$ -simplices of K . Indeed, K^* is $\partial(P^*)$. Let K_0 be a closed subcomplex of K and let K_0^* be the subcomplex of the star duals of the faces of K_0 .

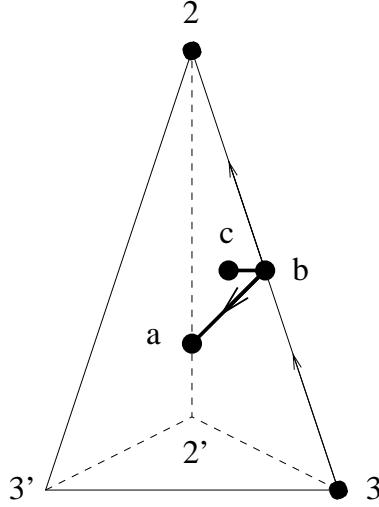

In the previous picture, let σ denote the oriented edge 32 . We assume that the orientation of the tetrahedron $(233'2')$ is given by the standard orientation of \mathbb{R}^3 . Then the star dual of σ is the sum of the oriented sum $cb + ba$ of the barycentric subdivision of $(233'2')$.

Let k be a positive integer and let $[c] \in \tilde{H}_k(K_0, \mathbb{Z})$ be a homology class represented by the cycle c . In K , the cycle c is the boundary of a $(k + 1)$ -chain d . Decompose d as

$$d = \sum a_i \sigma_i \qquad a_i \in \mathbb{Z}$$

where σ_i are cells of K . We can assume that a_i is zero if σ_i is in K_0 . Else, the boundaries of d and of d' where the sum appearing in d is restricted to $K \setminus K_0$ differ from a boundary in K_0 , hence both represent $[c]$.

Consider the star dual of d , that is the $(m - k - 1)$ -cochain

$$d^* = \sum a_i \sigma_i^*$$

Then d^* is a coboundary in K^* but only a cocycle in $K^* \setminus K_0^*$. The cohomology class of d^* in $\tilde{H}^{m-k-1}(K^* \setminus K_0^*, \mathbb{Z}) \simeq \tilde{H}^{m-k-1}(K \setminus K_0, \mathbb{Z})$ is the Alexander dual of $[c]$.

Let us give an example. We use the previous picture. Let K_0 denote the subcomplex of $(233'2')$ constituted by the two edges $22'$ and $33'$. Then $(233'2')^*$ is a tetrahedron whose facets are $2, 3, 3'$ and $2'$ whereas $(233'2')^* \setminus K_0^*$ is this tetrahedron minus the four (open) facets and minus the two (open) edges $22'$ and $33'$. The class of the 0-cycle $2 - 3$ is a generator of $\tilde{H}_0(K_0, \mathbb{Z})$. In $(233'2')$, it is the boundary of the oriented edge 32 . The Alexander dual of K_0 in $(233'2')^* \setminus K_0^*$ is the oriented edge 32 as shown in the following picture. It is a cocycle whose class generates $\tilde{H}^1((233'2')^* \setminus K_0^*, \mathbb{Z})$. The picture represents the tetrahedron $(233'2')^*$. The subcomplex $(233'2')^* \setminus K_0^*$ is constituted by the bold edges. Finally, the orientation of the edge 32 is given by the arrow. As before, the orientation of $(233'2')^*$ comes from the standard orientation of \mathbb{R}^3 .

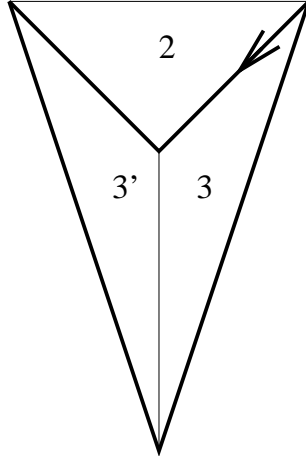

Remark 9.1. The barycentric subdivision of $K^* \setminus K_0^*$ identifies naturally with the mirror complex of K_0 . Via this identification, d^* is a cochain of this mirror complex. In the example given above, d^* is then the cochain $cb + ba$ drawn in $(ABCD)_b$. Nevertheless, d^* is *generally not a cocycle of the mirror complex of K_0* , since the barycentric subdivision of a cocycle of a complex does not generally remain a cocycle in the barycentric subdivision of this complex.

End of the proof of Theorem 7.6. Let \mathcal{I} be a proper subset of \mathcal{F} , and k an integer. Consider a class $[c]$ in $\tilde{H}_k(\text{link}_\Delta \sigma_{\mathcal{I}}, \mathbb{Z})$ represented by a simplicial k -cycle c . Then, in $S^{\tilde{\mathcal{I}}}$, the cycle c is the boundary of some simplicial $(k+1)$ -chain

$$d = \sum_{I \subset \tilde{\mathcal{I}}} a_I \sigma_I$$

As before, we assume that a_I is zero if $I \in \text{link}_\Delta \sigma_{\mathcal{I}}$, hence by Remark 7.11 we may keep only the sets I which belong to $\tilde{\mathcal{I}}$. Recall that σ_I is oriented from the order of the poset \mathcal{F} (see Section 8).

NB: in the sums we will use, we will only consider subsets that have a prescribed cardinal (for instance $k+2$ thereup). We will omit this precision in the sequel.

For a simplex σ_I in $S^{\tilde{\mathcal{I}}}$, we denote by σ_I^* its star dual in $(S^{\tilde{\mathcal{I}}})^*$. Then, the Alexander dual of $[c]$ in $\tilde{H}^{|\tilde{\mathcal{I}}|-k-3}((S^{\tilde{\mathcal{I}}})^* \setminus (\text{link}_\Delta \sigma_{\mathcal{I}})^*)$ is given by the class of

$$\sum_{I \in \tilde{\mathcal{I}}} a_I (\sigma_I^*).$$

Indeed, $(S^{\tilde{\mathcal{I}}})^* \setminus (\text{link}_\Delta \sigma_{\mathcal{I}})^*$ is isomorphic to $\tilde{\mathcal{I}}$ and the previous cochain is a cocycle in $\tilde{\mathcal{I}}$.

Let us now place in P_b . Recall that $\tilde{\mathcal{I}}$ is identified with $K_{\tilde{\mathcal{I}}}$ via the map

$$I \in \tilde{\mathcal{I}} \longmapsto \hat{I} \in K_{\tilde{\mathcal{I}}}$$

Denote $F_{\hat{I}}^*$ the image of $\sigma_{\hat{I}}^*$ via this map. We now have to compute the Alexander dual in ∂P of the cohomology class of

$$\sum_{I \in \tilde{\mathcal{I}}} a_I(F_I^*)$$

Obviously, the simplicial complex $K_{\tilde{\mathcal{I}}}$ is isomorphic to $\partial(P^*) \setminus P_{\mathcal{I}}^*$. Via this identification, $F_{\hat{I}}^*$ is the star dual in $(\partial P)^* = \partial(P^*)$ of $F_{\hat{I}}$ in $P_{\mathcal{I}}$.

Consider

$$(16) \quad \sum_{I \in \tilde{\mathcal{I}}} a_I \partial F_{\langle \hat{I} \rangle}$$

where the angles mean that the set \hat{I} is ordered in a way which may be different from the natural order induced by \mathcal{F} ; as explained in Section 8, the face $F_{\langle \hat{I} \rangle}$ is thus oriented. In the special case where \hat{I} is a singleton, then $F_{\langle \hat{I} \rangle}$ may be $F_{\hat{I}}$ or $-F_{\hat{I}}$, that is the facet \hat{I} with the orientation reversed. It follows from the construction of Alexander duals recalled above that, if the order on each subset of $\tilde{\mathcal{I}}$ is suitably chosen, then the former expression is a cycle whose class in $\tilde{H}_{k-|\tilde{\mathcal{I}}|+d+1}(P_{\mathcal{I}}, \mathbb{Z})$ is the searched Alexander dual.

Let us enlighten all this discussion with an example. Let P be the cube numbered as in Example 7.9. Let $\mathcal{I} = \{1, 1'\}$. Then,

$$link_{\Delta} \sigma_{\mathcal{I}} = \{2, 2', 3, 3', 22', 33'\}$$

Let c be the 0-cycle $2 - 3$ in $link_{\Delta} \sigma_{\mathcal{I}}$. We are exactly in the situation drawn in the two previous pictures. We thus have that the Alexander dual of $[c]$ in $\tilde{\mathcal{I}}$ is the oriented 1-cocycle 32 . Via the map recalled above, it corresponds to the oriented 1-cocycle $2'3'$ in $K_{\tilde{\mathcal{I}}}$. This cocycle is the star dual of the edge $2'3'$ of P . The boundary of this edge, that is $12'3' - 1'2'3'$ is a 0-cycle whose class is a generator of $\tilde{H}_0(P_{\mathcal{I}}, \mathbb{Z})$ as shown in the following picture.

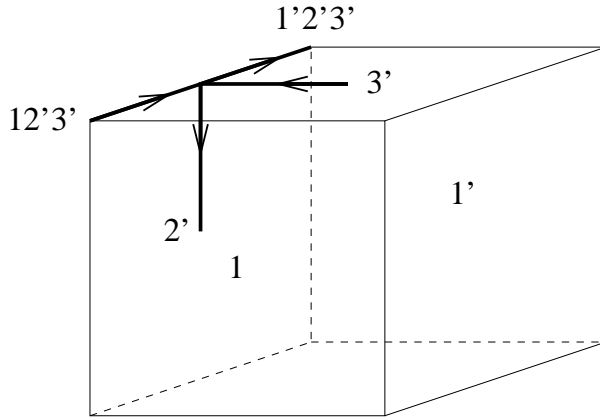

The expression (16) can be rewritten in another form using Lemma 8.6. This gives the following formula:

$$\phi([c]) = \left[\sum_{H \in \mathcal{I}, I \in \tilde{\mathcal{I}}, H \cap F_I \neq \emptyset} a_I F_{\langle \hat{I} \rangle} \cap H \right]$$

Let us now prove that the cup product operation on the cohomology of X corresponds (up to sign) to the operation of intersection on our homology classes (in the nonzero case), i.e. $\phi(\langle i_{\mathcal{J}} - i_{\mathcal{I}} \rangle * c * c') = \pm \phi([c]) \cap \phi([c'])$, where $i_{\mathcal{J}}$ (respectively $i_{\mathcal{I}}$) is an element of $\bar{\mathcal{J}}$ (respectively $\bar{\mathcal{I}}$).

Consider two subsets \mathcal{I} and \mathcal{J} of \mathcal{F} . If $\mathcal{I} \cup \mathcal{J}$ is not equal to \mathcal{F} , then the cup product of classes associated to homology elements of $P_{\mathcal{I}}$ and $P_{\mathcal{J}}$ is zero as it corresponds to the case $\sigma \cup \sigma' \neq [n]$ in [DL], Theorem 1.1. In the sequel, we assume that $\mathcal{I} \cup \mathcal{J} = \mathcal{F}$.

If we take \mathcal{I} equal to \mathcal{F} , then only $\tilde{H}_{d-1}(P_{\mathcal{I}}, \mathbb{Z})$ is nonzero and a class $[c]$ in it is a multiple of the top-class of ∂P . Moreover, $\psi([c])$ is in $H^0(X, \mathbb{Z})$, hence is a multiple (the same up to sign) of the unity of the cohomology ring of X . Therefore, both the intersection with $[c]$ and the cup product with $\psi([c])$ are, up to sign, multiplication by this integer. This proves the formula in the particular case $\mathcal{I} = \mathcal{F}$ ($\mathcal{J} = \mathcal{F}$ is identical).

From now on, we assume that \mathcal{I} and \mathcal{J} are distinct from \mathcal{F} (in particular they are nonempty as well). As we are working up to sign, we can assume:

Hypothesis : for the order on the facets, any element of $\bar{\mathcal{I}}$ is less than any element of $\bar{\mathcal{J}}$, i.e. $\bar{\mathcal{I}} \cup \bar{\mathcal{J}} = \bar{\mathcal{I}}\bar{\mathcal{J}}$ as ordered sets.

We thus consider an element $[c_{\mathcal{I}}]$ of $\tilde{H}_k(\text{link}_{\Delta} \sigma_{\mathcal{I}}, \mathbb{Z})$ and an element $[c_{\mathcal{J}}]$ of $\tilde{H}_{k'}(\text{link}_{\Delta} \sigma_{\mathcal{J}}, \mathbb{Z})$. Let $[c]$ be $[c_{\mathcal{I}} * c_{\mathcal{J}} * \langle i_{\mathcal{J}} - i_{\mathcal{I}} \rangle]$ in $\tilde{H}_{k+k'}(\text{link}_{\Delta} \sigma_{\mathcal{I} \cup \mathcal{J}}, \mathbb{Z})$. We have to see that $\phi([c])$ is, up to sign, the intersection of $\phi([c_{\mathcal{I}}])$ with $\phi([c_{\mathcal{J}}])$. Let $d_{\mathcal{I}}$ (respectively $d_{\mathcal{J}}$) be a $(k+1)$ -chain of $S^{\bar{\mathcal{I}}}$ (respectively a $(k+1)$ -chain of $S^{\bar{\mathcal{J}}}$) whose boundary has $[c_{\mathcal{I}}]$ (respectively $[c_{\mathcal{J}}]$) for class.

First, we find a chain in $S^{\bar{\mathcal{I}} \cup \bar{\mathcal{J}}}$ whose boundary has $[c]$ for class.

Lemma 9.2. *Consider two disjoint nonempty finite sets A and B . Consider a k -chain d_A and a k' -chain d_B in subcomplexes K_A and K_B of Δ_A and Δ_B . Then, up to sign, $\partial(d_A * d_B)$ is homologous to $\partial d_A * \partial d_B * \langle i_A - i_B \rangle$ in $K_A * \Delta_B \cup \Delta_A * K_B$, where i_A and i_B denote elements of A and B respectively.*

Proof. In fact, we show that $\partial(d_A * d_B)$ is homologous to $\partial d_A * \langle i_B - i_A \rangle * \partial d_B$ which is clearly equal up to sign to $\partial d_A * \partial d_B * \langle i_A - i_B \rangle$.

We have $\partial(d_A * d_B) = \partial d_A * d_B + (-1)^{k+1} d_A * \partial d_B$. We then just have to see that $\partial d_A * d_B$ and $\partial d_A * \langle i_B \rangle * \partial d_B$ differ from a boundary and that $(-1)^{k+1} d_A * \partial d_B$ and $\partial d_A * \langle -i_A \rangle * \partial d_B$ do too.

The boundary of $\langle i_B \rangle * \partial d_B$ is ∂d_B . Hence, d_B and $\langle i_B \rangle * \partial d_B$ differ from a cycle and this cycle is a boundary in Δ_B as it is not 0-dimensional. This gives immediately that $\partial d_A * d_B$ and $\partial d_A * \langle i_B \rangle * \partial d_B$ differ from a boundary in $K_A * \Delta_B$.

We have $\partial d_A * \langle -i_A \rangle = (-1)^{k+1} \langle i_A \rangle * \partial d_A$ and, as above, $\partial d_A * \langle -i_A \rangle * \partial d_B$ and $(-1)^{k+1} d_A * \partial d_B$ differ from a boundary in $\Delta_A * K_B$.

This proves the lemma. \square

In our context, the lemma shows that we can take $d_{\mathcal{I}} * d_{\mathcal{J}}$ as chain having the desired boundary.

We then can compute $\phi([c])$. Suppose we have

$$d_{\mathcal{I}} = \sum_{I \in \bar{\mathcal{I}}} a_I \sigma_I \quad \text{and} \quad d_{\mathcal{J}} = \sum_{J \in \bar{\mathcal{J}}} b_J \sigma_J$$

Then, as $\bar{\mathcal{I}}$ and $\bar{\mathcal{J}}$ are disjoint, we have thanks to the chosen order:

$$d_{\mathcal{I}} * d_{\mathcal{J}} = \sum_{I \in \bar{\mathcal{I}}, J \in \bar{\mathcal{J}}} a_I b_J \sigma_{I \cup J}$$

In fact, as noted at the beginning of this Section, we may replace $d_{\mathcal{I}} * d_{\mathcal{J}}$ by a homologous chain in $S^{\bar{\mathcal{I}} \cup \bar{\mathcal{J}}} \setminus \widetilde{\text{link}}_{\Delta}(\sigma_{\mathcal{I} \cap \mathcal{J}})$, by keeping in the former equation only the couples (I, J) such that $I \cup J$ is in $\bar{\mathcal{I}} \cap \bar{\mathcal{J}}$.

The following lemma ensures us that the intersection of two cycles is again a cycle.

Lemma 9.3. *Up to a sign that is independent of I and J (but which depends on their cardinal), we get $F_{\langle \hat{I} \cup \hat{J} \rangle} = F_{\langle \hat{I} \rangle + \langle \hat{J} \rangle}$ (when these intersections are nonempty).*

Proof. Both members of the equality represent $F_{\langle \hat{I} \cup \hat{J} \rangle}$, hence are equal up to sign. To compute this sign, we have to understand which is the orientation of $F_{\langle \hat{I} \rangle}$ knowing I .

The polytope P , the simplicial sphere $S^{\bar{\mathcal{I}}}$ and σ_I are oriented. As explained above, this induces an orientation of the star dual σ_I^* . Via the isomorphism of complexes given by $I \rightarrow \hat{I}$, an orientation is fixed on the image $F_{\hat{I}}^*$ of σ_I^* . We order $\langle \hat{I} \rangle$ so that the star dual of $F_{\langle \hat{I} \rangle}$ is $F_{\hat{I}}^*$.

Note $\epsilon_{\langle \hat{I} \rangle}$ being +1 if $F_{\langle \hat{I} \rangle}$ is oriented like $F_{\hat{I}}^*$ and -1 else. We want to show that $\epsilon_{\langle \hat{I} \rangle} \cdot \epsilon_{\langle \hat{J} \rangle} \cdot \epsilon_{\langle \hat{I} \cup \hat{J} \rangle}$ neither depends on I nor on J . We will in fact prove more than stated in the lemma, since we will give the exact sign of this product. This will be useful in the next Section.

The (unoriented) star dual of σ_I in $(S^{\bar{\mathcal{I}}})_b \setminus (\text{link}_{\Delta} \sigma_{\mathcal{I}})_b \simeq \tilde{\mathcal{I}}_b$ is in fact the order complex C_I on the sets I' such that $I \subset I' \subsetneq \bar{\mathcal{I}}$. Under the identification between the mirror complex of $\text{link}_{\Delta} \sigma_{\mathcal{I}}$ and $(K_{\bar{\mathcal{I}}})_b$, the complex C_I may also be seen as the (unoriented) star dual of $F_{\langle \hat{I} \rangle}$. It is easy to check that, due to the simpleness of P , it is besides isomorphic to the barycentric subdivision of the simplex $\Delta_{\hat{I}}$ with vertex set \hat{I} . To simplify the proof, we will, by abuse of notation, call C_I these three complexes.

As a consequence of the identification between C_I and $\Delta_{\hat{I}}$, an ordering of $\langle \hat{I} \rangle$ induces an orientation of C_I . The star dual orientation is the one for which the intersection number $\sigma_I \times C_I$ is 1. On the other hand, when we see C_I as a subcomplex of ∂P_b , the star dual orientation is the one for which the intersection number $F_{\langle \hat{I} \rangle} \times C_I$ is 1. In particular, for any orientation of C_I , these two intersection numbers are the same.

Put on C_I the orientation given by the natural order of \hat{I} as subset of \mathcal{F} . Remark that the sets $\hat{I}I$ and $\bar{\mathcal{I}}$ are the same up to a permutation. Let $\epsilon_{\hat{I}I}$ denote the sign of this permutation.

We claim that, with the orientation we have fixed on C_I , we have:

$$(17) \quad \sigma_I \times C_I = F_{\langle \hat{I} \rangle} \times C_I = (-1)^{(|\hat{I}|-1)(|I|-1)} \cdot \epsilon_{\hat{I}I}$$

This can be shown as follows. We still identify C_I with $(\Delta_{\hat{I}})_b$. Let $\hat{I} = \{\hat{i}_0 < \dots < \hat{i}_l\}$. Consider the positively oriented simplex $\sigma = J_0 < \dots < J_l$ of $(\Delta_{\hat{I}})_b$ defined by $J_s = \hat{i}_0 \dots \hat{i}_s$.

On the other hand, consider the oriented barycentric subdivision $(S^{\bar{\mathcal{I}}})_b$. Consider $(\sigma_I)_b$. Let $I = \{i_0 < \dots < i_{k+1}\}$ and consider the positively oriented simplex $\sigma' = I_0 < \dots < I_{k+1}$ defined by $I_s = i_s \dots i_{k+1}$.

In the sphere $(S^{\bar{\mathcal{I}}})_b$, the simplex σ corresponds in fact via the map $I \mapsto \hat{I}$ to the simplex $\bar{\mathcal{I}} \setminus J_0 < \dots < \bar{\mathcal{I}} \setminus J_l$. Notice that

$$\bar{\mathcal{I}} \setminus J_l = \bar{\mathcal{I}} \setminus \hat{I} = I = I_0$$

so we may consider the simplex

$$\bar{\mathcal{I}} \setminus J_0 < \dots < \bar{\mathcal{I}} \setminus J_l = I_0 < \dots < I_{k+1}$$

It is easy to check that this simplex induces the orientation $\hat{I}I$ on $S^{\bar{\mathcal{I}}}$.

Consider now the “reversed simplex”

$$I_{k+1} < \dots < I_0 = \bar{\mathcal{I}} \setminus J_l < \dots < \bar{\mathcal{I}} \setminus J_0$$

It induces on $S^{\bar{\mathcal{I}}}$ an orientation which differs from the previous one and is equal to

$$\epsilon = (-1)^{(k+l+1)(k+l+2)/2} \cdot \epsilon_{\hat{I}I}.$$

In the same way, the simplex $I_{k+1} < \dots < I_0$ of $(\sigma_I)_b$ is no more positive but with sign

$$\epsilon' = (-1)^{(k+1)(k+2)/2}$$

and the simplex $\bar{\mathcal{I}} \setminus J_l < \dots < \bar{\mathcal{I}} \setminus J_0$ is no more positive but with sign

$$\epsilon'' = (-1)^{l(l+1)/2}$$

By [Al], t. 3, p.11–17, the intersection number $\sigma_I \times C_I$ is given by the product $\epsilon \cdot \epsilon' \cdot \epsilon''$. A direct computation shows now the claim.

Of course, putting the natural orders on \hat{J} and $\widehat{I \cup J}$, the same argument implies that

$$(18) \quad \begin{aligned} \sigma_J \times C_J &= F_{\langle \hat{J} \rangle} \times C_J = (-1)^{(|\hat{J}|-1)(|J|-1)} \cdot \epsilon_{\hat{J}J} \\ \sigma_{I \cup J} \times C_{I \cup J} &= (-1)^{(|\hat{I \cup J}|-1)(|I \cup J|-1)} \cdot \epsilon_{\widehat{I \cup J} I \cup J} = F_{\langle \widehat{I \cup J} \rangle} \times C_{I \cup J} \end{aligned}$$

Let us consider now the situation on ∂P . By definition, we have

$$F_{\langle \hat{I} \rangle} \times F_{\hat{I}}^* = 1 \quad \text{and} \quad F_{\hat{I}} \times F_{\hat{I}}^* = \epsilon_{\langle \hat{I} \rangle}$$

Let now (H_0, \dots, H_l) be a collection of hyperplanes supporting facets of P such that $F_{\hat{I}}$ is equal to $F_{(H_0, \dots, H_l)}$. The two previous intersection numbers can be interpreted as follows. Let $\langle B \rangle$ and B^* be respective positive basis of $F_{\langle \hat{I} \rangle}$ and $F_{\hat{I}}^*$ (more exactly of its part lying on H_0). Let $B_{F_{\hat{I}}}^+$ be a positive basis of the face $F_{\hat{I}}$. Finally, let v_i denote an outward pointing normal vector to H_i for i between 0 and l . Then the basis $(v_0, \langle B \rangle, B^*)$ of \mathbb{R}^d is direct, whereas $(v_0, B_{F_{\hat{I}}}^+, B^*)$ is a basis of \mathbb{R}^d whose sign is $\epsilon_{\langle \hat{I} \rangle}$. On the other hand, we have that (v_1, \dots, v_l) is a direct basis of

C_I , therefore the sign of the permutation transforming (v_1, \dots, v_l) into B^* is equal to the intersection number $F_{\langle \hat{I} \rangle} \times C_I$.

With our conventions, to say that $B_{F_i}^+$ is positive means exactly that the basis $(v_0, \dots, v_l, B_{F_i}^+)$ is direct. The sign of $(v_0, B_{F_i}^+, B^*)$ is also given as the sign of the transformation sending it to $(v_0, \dots, v_l, B_{F_i}^+)$, or to the product of the sign of the transformation sending it to $(v_0, B^*, B_{F_i}^+)$ by the sign of the transformation sending $(v_0, B^*, B_{F_i}^+)$ to $(v_0, \dots, v_l, B_{F_i}^+)$. By what precedes, this last sign is equal to the intersection number $F_{\langle \hat{I} \rangle} \times C_I$.

As a consequence of all this and of (17), we obtain the following identity

$$\begin{aligned} \epsilon_{\langle \hat{I} \rangle} &= (-1)^{(|\hat{I}|-1)(|I|-1)} \cdot \epsilon_{\hat{I}I} \cdot (-1)^{\dim F_{\hat{I}} \cdot l} \\ (19) \quad &= (-1)^{(|\hat{I}|-1)(|I|-1)} \cdot \epsilon_{\hat{I}I} \cdot (-1)^{d-|\hat{I}| \cdot (|\hat{I}|-1)} \\ &= (-1)^{(|\hat{I}|-1)(|I|-1)} \cdot \epsilon_{\hat{I}I} \cdot (-1)^d \end{aligned}$$

The previous equality is naturally also true for J and $I \cup J$. As a consequence of (17), (18), (19) and of the hypothesis made above, we have, after computation,

$$\epsilon_{\langle \hat{I} \rangle} \epsilon_{\langle \hat{J} \rangle} \epsilon_{\langle \hat{I} \cup \hat{J} \rangle} = (-1)^{1+|\hat{I}| \cdot |J| + |\hat{J}| \cdot |I|} \cdot \epsilon_{\hat{I}I} \epsilon_{\hat{J}J} \epsilon_{\hat{I}\hat{J}IJ} \cdot (-1)^d$$

Now, the product $\epsilon_{\hat{I}I} \epsilon_{\hat{J}J}$ sends the ordered set $\tilde{I} \cup \tilde{J}$ to $\hat{I}\hat{J}J$ and $\epsilon_{\hat{I}\hat{J}IJ}$ sends this same ordered set to $\hat{I}\hat{J}IJ$. Their product is the sign of the permutation which permutes I and \hat{J} , hence is equal to $(-1)^{|I| \cdot |\hat{J}|}$.

This finally gives

$$\epsilon_{\langle \hat{I} \rangle} \epsilon_{\langle \hat{J} \rangle} \epsilon_{\langle \hat{I} \cup \hat{J} \rangle} = (-1)^{1+|\hat{I}| \cdot |J| + |\hat{J}| \cdot |I| + d + |I| \cdot |\hat{J}|} = (-1)^{d+1+|\hat{I}| \cdot |J|},$$

a sign which is independent of I and J . \square

Thanks to this lemma, we can claim that, up to sign

$$\phi([c]) = \left[\sum_{I \in \tilde{\mathcal{I}}, J \in \tilde{\mathcal{J}}} a_I b_J \partial F_{\langle \hat{I} \rangle + \langle \hat{J} \rangle} \right]$$

By Lemma 8.6, this gives us then, up to sign

$$\phi([c]) = \left[\sum_{I \in \tilde{\mathcal{I}}, J \in \tilde{\mathcal{J}}, H \in \mathcal{I} \cap \mathcal{J}} a_I b_J F_{\langle \hat{I} \rangle + \langle \hat{J} \rangle} \cap H \right]$$

On the other side, we have to compute the intersection of $\phi([c_{\mathcal{I}}])$ and $\phi([c_{\mathcal{J}}])$. Let us write them

$$\begin{aligned} \phi([c_{\mathcal{I}}]) &= \left[\sum_{H \in \mathcal{I}; I \in \tilde{\mathcal{I}}; F_{\langle \hat{I} \rangle} \cap H \neq \emptyset} a_I F_{\langle \hat{I} \rangle} \cap H \right] \\ \phi([c_{\mathcal{J}}]) &= \left[\sum_{H' \in \mathcal{J}; J \in \tilde{\mathcal{J}}; F_{\langle \hat{J} \rangle} \cap H' \neq \emptyset} b_J F_{\langle \hat{J} \rangle} \cap H' \right] \end{aligned}$$

These two classes are naturally realised in the boundaries of $\mathcal{F}_{\mathcal{I}}$ and $\mathcal{F}_{\mathcal{J}}$ but do not then meet transversely. We can nevertheless "push" them in the interior of these sets so that they do.

Definition 9.4. Consider a simple polytope P and for each of its facet H an affine function l_H on the space of P which is zero on H and positive on $P \setminus H$. For $\epsilon > 0$, call $H_\epsilon = l_H^{-1}(\epsilon) \cap P$ and for a face F of P , note $F_\epsilon = \bigcap_{H \supset F} H_\epsilon$.

Lemma 9.5. Consider now two faces F and F' of a simple polytope P that are not contained in a common facet and have nonempty intersection. Then, if ϵ is small enough, ∂F_ϵ and $\partial F'_\epsilon$ meet transversely and their intersection is $\partial(F \cap F')_\epsilon$. Moreover, this also works when we deal with oriented faces.

This lemma is clear.

We now can compute the homology class of the intersection of our two cycles. For this, consider for every facet of P an affine function satisfying the properties Definition 9.4.

Take $\epsilon > 0$ small enough. Define $\phi_\epsilon([c_{\mathcal{I}}])$ as follows : for an element I of $\tilde{\mathcal{I}}$ and a facet H of \mathcal{I} meeting F_I , call $(F_I \cap H)_{H,\epsilon}$ the set $(F_I \cap H)_\epsilon$ when we consider H as a simple polytope and restrict the affine functions of the facets meeting H to the facets of H . Just remark now that

$$\phi([c_{\mathcal{I}}]) = \left[\sum_{H \in \mathcal{I}; I \in \tilde{\mathcal{I}}; F_{\langle \hat{I} \rangle} \cap H \neq \emptyset} a_I (F_{\langle \hat{I} \rangle} \cap H)_{H,\epsilon} \right]$$

since the cycle in the brackets thereup is homotopic to $\sum_{H \in \mathcal{I}; I \in \tilde{\mathcal{I}}; F_{\langle \hat{I} \rangle} \cap H \neq \emptyset} a_I F_{\langle \hat{I} \rangle} \cap H$.

Of course, the same is true for $\phi([c_{\mathcal{J}}])$. But these cycles meet transversely and, thanks to Lemma 9.5, their intersection can be written:

$$\phi([c_{\mathcal{I}}]) \cap \phi([c_{\mathcal{J}}]) = \left[\sum_{H \in \mathcal{I}; I \in \tilde{\mathcal{I}}; J \in \tilde{\mathcal{J}}; F_{\langle \hat{I} \rangle} \cap F_{\langle \hat{J} \rangle} \cap H \neq \emptyset} a_I b_J (F_{\langle \hat{I} \rangle} \cap F_{\langle \hat{J} \rangle} \cap H)_{H,\epsilon} \right]$$

And this last expression is then $\phi([c_{\mathcal{I}} \cap c_{\mathcal{J}}])$.

We get finally, up to sign:

$$\phi([c_{\mathcal{I}}]) \cap \phi([c_{\mathcal{J}}]) = \left[\sum_{I \in \tilde{\mathcal{I}}, J \in \tilde{\mathcal{J}}, H \in \mathcal{I} \cap \mathcal{J}} a_I b_J F_{\langle \hat{I} \rangle + \langle \hat{J} \rangle} \cap H \right] = \phi([c])$$

This completes the demonstration of the Theorem. \square

10. Computation of the sign

In the previous Section, the product of two generators of the cohomology of X was computed up to sign. Here do we compute it precisely. This gives:

Sign Theorem 10.1. Consider $[c] \in \tilde{H}_k(P_{\mathcal{I}}, \mathbb{Z})$ and $[c'] \in \tilde{H}_{k'}(P_{\mathcal{J}}, \mathbb{Z})$ as in the statement of Cohomology Theorem 7.6. Set $K' = |\tilde{\mathcal{J}}| - d + k' - 1$. Denote by $\epsilon_{\tilde{\mathcal{I}}\tilde{\mathcal{J}}}$ the sign of the permutation transforming $\tilde{\mathcal{I}}\tilde{\mathcal{J}}$ into $\tilde{\mathcal{I}} \cup \tilde{\mathcal{J}}$. Then,

$$\psi([c]) \smile \psi([c']) = \epsilon_{\tilde{\mathcal{I}}\tilde{\mathcal{J}}} \psi([c] \cap [c'])$$

with

$$\epsilon = \begin{cases} \epsilon_{\bar{\mathcal{I}}\bar{\mathcal{J}}} \cdot (-1)^{(d+1+n+K'|\bar{\mathcal{I}}|)} & \text{if neither } \bar{\mathcal{I}} \text{ nor } \bar{\mathcal{J}} \text{ is empty.} \\ 1 & \text{if at least one is.} \end{cases}$$

Proof. In the special case where $\mathcal{I} = \mathcal{F}$, the class $[c]$ is a multiple of the top class of ∂P and $\psi([c])$ is a multiple of the unity of the cohomology ring of X . The intersection of $[c]$ with any class $[c']$ and the cup product of $\psi([c])$ with $\psi([c'])$ are just multiplications by integers and ϵ is 1.

For the general case, let $[c] \in \tilde{H}_k(P_{\mathcal{I}}, \mathbb{Z})$ and $[c'] \in \tilde{H}_{k'}(P_{\mathcal{J}}, \mathbb{Z})$. Due to Lemma 7.12, they correspond to classes $[c_1] \in \tilde{H}_K(\text{link}_{\Delta}\sigma_{\mathcal{I}}, \mathbb{Z})$ and $[c_2] \in \tilde{H}_{K'}(\text{link}_{\Delta}\sigma_{\mathcal{J}}, \mathbb{Z})$ with

$$K = |\bar{\mathcal{I}}| - d + k - 1 \quad \text{and} \quad K' = |\bar{\mathcal{J}}| - d + k' - 1$$

Let us recall now de Longueville's results. The cup product of these two classes is the class of $(-1)^{n+K(K'+1)+1} \langle i_{\bar{\mathcal{J}}} - i_{\bar{\mathcal{I}}} \rangle * c_1 * c_2$ in $\tilde{H}_{K+K'+2}(\text{link}_{\Delta}(\sigma_{\mathcal{I}} \cap \sigma_{\mathcal{J}}), \mathbb{Z})$. Due to the proof of Lemma 9.2, if we take the class associated to the boundary of $d_{\mathcal{I}} * d_{\mathcal{J}}$ instead of $\langle i_{\bar{\mathcal{J}}} - i_{\bar{\mathcal{I}}} \rangle * c_1 * c_2$, the sign is $(-1)^{n+KK'}$.

When passing to the classes in ∂P , a sign comes: it is explicitly described in the proof of Lemma 9.3 and is equal to

$$(-1)^{d+1+(K'+2)(|\bar{\mathcal{I}}|-K-2)} = (-1)^{d+1+K'(|\bar{\mathcal{I}}|-K)}$$

under the hypothesis that in the order of \mathcal{F} , the elements of $\bar{\mathcal{I}}$ are lower than the elements of $\bar{\mathcal{J}}$. There exists a permutation which reorders $\bar{\mathcal{I}} \cup \bar{\mathcal{J}}$ such as this assumption holds and we thus have to multiply the result by $\epsilon_{\bar{\mathcal{I}}\bar{\mathcal{J}}}$, the sign of this permutation.

Putting all these results together gives the formula of Sign Theorem 10.1. \square

11. Applications to the topology of the links

In this Section we make use of the previous results on the cohomology ring of a 2-connected link X to investigate how complicated can the topology of a link be. We will see that the complexity increases when the dimension d of the associate polytope P increases and that the topology of a link may finally be ‘‘arbitrarily complicated’’.

For $d = 0$, the unique 2-connected link is a point, for $d = 1$ it is \mathbb{S}^3 (this is the case $p = 0$ and $n = 2$). For the polygons, the situation is not so easy and the links are products of odd-dimensional spheres or connected sums of products of spheres: this case was completely described in [McG] (cf Theorem 6.3). In higher dimensions, the only known case is the special case where $p = 2$ [LdM1], [LdM2] where the same type of manifolds is obtained (cf Example 0.5). On the other hand, the generalization of MacGavran's results stated as Theorem 6.3 shows that, for any value of d , there is an infinite number of examples where the link is a connected sum of products of spheres. This leads naturally to the following question, whose positive answer was stated as a conjecture in [Me1]

Question A. *Is it true that any 2-connected link may be decomposed into a product of odd-dimensional spheres and connected sums of products of spheres?*

A weaker version of this question is

Question A’. *At least, is it true that the cohomology ring of a 2-connected link is isomorphic to the cohomology ring of a product of odd-dimensional spheres and connected sums of products of spheres?*

This supposes to resolve first the (easier?)

Question A’. *Is it true that the homology of a 2-connected link is always without any torsion?*

An immediate application of Cohomology Theorem 7.6 is that the answer is yes if d is lower than 4.

Corollary 11.1. *If the polytope P has dimension at most 4, then the homology of the associated manifold is torsion free.*

Proof. In this case, every homology group of the form $\tilde{H}_k(P_{\mathcal{I}}, \mathbb{Z})$ is torsion free, as $P_{\mathcal{I}}$ lies in ∂P which is a sphere of dimension ≤ 3 (see [Al], t. 3, Chapter XIII, paragraph 4.12). So is a direct sum of such groups as are the cohomology groups of X by Cohomology Theorem 7.6. \square

We emphasize that this result obtained as an easy consequence of Cohomology Theorem 7.6 should not be easily deduced from the classical form of the Goresky-Mac Pherson formula (for example in the version of [DL]) applied to the complement of subspace arrangement \mathcal{S} , since the dimension of the complex Δ on which the homology computations have to be done can be much greater than 3. Therefore, this Corollary illustrates all the interest in having a formula in terms of subsets of the associate polytope.

We will now prove that, even in dimension 3, the answer to questions A and A’ is negative. To see this, we will first compute how the cohomology of a link X changes when performing an elementary surgery of type $(1, n)$ on $X \times \mathbb{S}^1$, that is when performing a vertex cutting on P . Recall that, by Lemma 6.1, the diffeomorphism type of the new link X' is independent of the choice of the vertex to be cut off.

Proposition 11.2. *Let X and X' as above. Assume that $d \geq 2$. Then:*

$$H^0(X', \mathbb{Z}) \simeq H^{n+d+1}(X', \mathbb{Z}) \simeq \mathbb{Z}$$

$$H^1(X', \mathbb{Z}) \simeq H^2(X', \mathbb{Z}) \simeq H^{n+d-1}(X', \mathbb{Z}) \simeq H^{n+d}(X', \mathbb{Z}) \simeq 0$$

$$H^i(X', \mathbb{Z}) \simeq H^i(X, \mathbb{Z}) \oplus H^{i-1}(X, \mathbb{Z}) \oplus \mathbb{Z}^{\binom{n-d}{i-2d+1}} \oplus \mathbb{Z}^{\binom{n-d}{i-2}} \text{ if } 3 \leq i \leq n+d-2$$

where $\binom{l}{k}$ is zero if $k < 0$ or $k > l$.

Moreover, the product is given by the following rules considering two cohomology classes $[c]$ and $[c']$ of X' :

Rule 1: *if $[c]$ or $[c']$ is in $H^0(X', \mathbb{Z})$ or $H^{n+d+1}(X', \mathbb{Z})$, then the product is the obvious one.*

Assume this is not the case. Then note $S_{i,j}$ for $3 \leq i \leq n+d-2$ and $1 \leq j \leq 4$, the sums thereup when they exist, that is

$$H^i(X', \mathbb{Z}) = S_{i,1} \oplus S_{i,2} \oplus S_{i,3} \oplus S_{i,4} .$$

For $j = 1$ or $j = 2$, decompose $S_{i,j}$ as $\oplus_{\mathcal{I} \subset \mathcal{F}} S_{\mathcal{I},j}$ as in Cohomology Theorem 7.6. Finally denote by S_j , for $1 \leq j \leq 4$ the sums of $S_{i,j}$ when i varies. We assume that $[c]$ is in $S_{\mathcal{I},j}$ and $[c']$ in $S_{\mathcal{J},j'}$.

Rule 2: if $\{j, j'\} \neq \{1\}, \{1, 2\}, \{3, 4\}$ then $[c] \smile [c'] = 0$.

Call φ_1 and φ_2 the applications of $H^i(X, \mathbb{Z})$ in $S_{i,1}$ and $S_{i+1,2}$.

Rule 3: if $j = j' = 1$, then we can assume that $[c] = \varphi_1([c_1])$ and $[c'] = \varphi_1([c'_1])$. Then $[c] \smile [c'] = -\varphi_1([c_1] \smile [c'_1])$.

Rule 4: if $j = 1$ and $j' = 2$, then we can assume that $[c] = \varphi_1([c_1])$ and $[c'] = \varphi_2([c'_2])$. Then $[c] \smile [c'] = -\varphi_2([c_1] \smile [c'_2])$.

Rule 5: the cup product from $S_3 \times S_4$ to $H^{n+d+1}(X, \mathbb{Z}) \simeq \mathbb{Z}$ is a unimodular bilinear form, which is diagonal in the canonical basis (when these basis are suitably ordered). Note that the product vanishes when dimensions do not correspond.

In particular, if the cohomology of X has no torsion, then so has the cohomology of X' .

Remark 11.3. The isomorphisms are not completely canonical. Some judicious choices have to be made to obtain the desired rules about the cup product.

Proof. Let v be the cut vertex, \mathcal{F}_v the set of the facets of P that contain v and F the "new" facet (we will not distinguish a facet of P -even in \mathcal{F}_v - from the "same" facet of P').

Notation 11.4. For a subset \mathcal{I} of \mathcal{F} , we will denote \mathcal{I}_2 the subset of the facets of P' having the same elements as \mathcal{I} and \mathcal{I}_1 the subset of the facets of P' where we add F to the ones of \mathcal{I} .

Let $\mathcal{I} \subset \mathcal{F}$ such that the intersection of \mathcal{I} with \mathcal{F}_v is proper and nonempty; then v belongs to the topological boundary of $P_{\mathcal{I}}$ and both $P'_{\mathcal{I}_1}$ and $P'_{\mathcal{I}_2}$ are homotopy equivalent to $P_{\mathcal{I}}$. Therefore, the three sets have the same reduced homology groups.

Consider now a subset \mathcal{I} of \mathcal{F} that contains \mathcal{F}_v . Then $P'_{\mathcal{I}_1}$ is homotopy equivalent to $P_{\mathcal{I}}$, hence has the same reduced homology groups and $P'_{\mathcal{I}_2}$ is homotopy equivalent to $P_{\mathcal{I}}$ minus a point. Therefore, if $\mathcal{I} \neq \mathcal{F}$, then the reduced homology groups of $P'_{\mathcal{I}_2}$ are isomorphic to the ones of $P_{\mathcal{I}}$ except $\tilde{H}_{d-2}(P'_{\mathcal{I}_2}, \mathbb{Z})$ which is isomorphic to $\tilde{H}_{d-2}(P_{\mathcal{I}}, \mathbb{Z}) \oplus \mathbb{Z}$. And if $\mathcal{I} = \mathcal{F}$, then $P'_{\mathcal{I}_2}$ is contractible, hence has no reduced homology.

Consider now a subset \mathcal{I} of \mathcal{F} that is disjoint from \mathcal{F}_v . Then $P'_{\mathcal{I}_2}$ is homotopy equivalent to $P_{\mathcal{I}}$, hence has the same reduced homology groups and $P'_{\mathcal{I}_1}$ is homotopy equivalent to the disjoint union of $P_{\mathcal{I}}$ with a point. Therefore, if $\mathcal{I} \neq \emptyset$, then the reduced homology groups of $P'_{\mathcal{I}_1}$ are isomorphic to the ones of $P_{\mathcal{I}}$ except $\tilde{H}_0(P'_{\mathcal{I}_1}, \mathbb{Z})$ which is isomorphic to $\tilde{H}_0(P_{\mathcal{I}}, \mathbb{Z}) \oplus \mathbb{Z}$. And if $\mathcal{I} = \emptyset$, then $P'_{\{F\}} = F$ is contractible and has no reduced homology.

Let i be an integer. Then, the above results allow us to compute $H^i(X', \mathbb{Z})$. This gives:

$$\begin{aligned} H^i(X', \mathbb{Z}) &\simeq \bigoplus_{\mathcal{I} \subset \mathcal{F}} \tilde{H}_{d+|\bar{\mathcal{I}}_1|-i-1}(P'_{\mathcal{I}_1}, \mathbb{Z}) \bigoplus \bigoplus_{\mathcal{I} \subset \mathcal{F}} \tilde{H}_{d+|\bar{\mathcal{I}}_2|-i-1}(P'_{\mathcal{I}_2}, \mathbb{Z}) \\ &\simeq \bigoplus_{\mathcal{I} \subset \mathcal{F}} \tilde{H}_{d+|\bar{\mathcal{I}}|-i-1}(P'_{\mathcal{I}_1}, \mathbb{Z}) \bigoplus \bigoplus_{\mathcal{I} \subset \mathcal{F}} \tilde{H}_{d+|\bar{\mathcal{I}}|-i}(P'_{\mathcal{I}_2}, \mathbb{Z}) \end{aligned}$$

which is isomorphic to

$$\begin{aligned} & \bigoplus_{\mathcal{I} \subset \mathcal{F}, \mathcal{I} \cap \mathcal{F}_v \neq \emptyset} \tilde{H}_{d+|\bar{\mathcal{I}}|-i-1}(P_{\mathcal{I}}, \mathbb{Z}) \quad \bigoplus_{\mathcal{I} \subset \mathcal{F}, \mathcal{I} \cap \mathcal{F}_v = \emptyset, \mathcal{I} \neq \emptyset} \left(\tilde{H}_{d+|\bar{\mathcal{I}}|-i-1}(P_{\mathcal{I}}, \mathbb{Z}) \oplus \mathbb{Z}^{\delta_{i+1}^{d+|\bar{\mathcal{I}}|}} \right) \\ & \bigoplus_{\mathcal{I} \subset \mathcal{F}, \mathcal{I} \not\subset \mathcal{F}_v} \tilde{H}_{d+|\bar{\mathcal{I}}|-i}(P_{\mathcal{I}}, \mathbb{Z}) \quad \bigoplus_{\mathcal{I} \subset \mathcal{F}, \mathcal{I} \supset \mathcal{F}_v, \mathcal{I} \neq \mathcal{F}} \left(\tilde{H}_{d+|\bar{\mathcal{I}}|-i}(P_{\mathcal{I}}, \mathbb{Z}) \oplus \mathbb{Z}^{\delta_{d-2}^{d+|\bar{\mathcal{I}}|-i}} \right) \end{aligned}$$

and finally to

$$\begin{aligned} & \bigoplus_{\mathcal{I} \subset \mathcal{F}, \mathcal{I} \neq \emptyset} \tilde{H}_{d+|\bar{\mathcal{I}}|-i-1}(P_{\mathcal{I}}, \mathbb{Z}) \quad \bigoplus_{\mathcal{I} \subset \mathcal{F}, \mathcal{I} \neq \mathcal{F}} \tilde{H}_{d+|\bar{\mathcal{I}}|-i}(P_{\mathcal{I}}, \mathbb{Z}) \\ & \bigoplus_{\mathcal{I} \subset \mathcal{F}, \mathcal{I} \cap \mathcal{F}_v = \emptyset, \mathcal{I} \neq \emptyset} \mathbb{Z}^{\delta_{i-d+1}^{|\bar{\mathcal{I}}|}} \quad \bigoplus_{\mathcal{I} \subset \mathcal{F}, \mathcal{I} \supset \mathcal{F}_v, \mathcal{I} \neq \mathcal{F}} \mathbb{Z}^{\delta_{i-2}^{|\bar{\mathcal{I}}|}} \end{aligned}$$

The sum $\bigoplus_{\mathcal{I} \subset \mathcal{F}, \mathcal{I} \neq \emptyset} \tilde{H}_{d+|\bar{\mathcal{I}}|-i-1}(P_{\mathcal{I}}, \mathbb{Z})$ is isomorphic to $H^i(X, \mathbb{Z})$, except if $d + n - i - 1 = -1$, i.e. $i = d + n$.

Also, the sum $\bigoplus_{\mathcal{I} \subset \mathcal{F}, \mathcal{I} \neq \mathcal{F}} \tilde{H}_{d+|\bar{\mathcal{I}}|-i}(P_{\mathcal{I}}, \mathbb{Z})$ is isomorphic to $H^{i-1}(X, \mathbb{Z})$, except if $d - i = d - 1$, i.e. $i = 1$.

On the other side,

$$\sum_{\mathcal{I} \subset \mathcal{F}, \mathcal{I} \cap \mathcal{F}_v = \emptyset, \mathcal{I} \neq \emptyset} \delta_{i-d+1}^{|\bar{\mathcal{I}}|}$$

is the number of nonempty subsets of $\mathcal{F} \setminus \mathcal{F}_v$ having $n - i + d - 1$ elements. It is $\binom{n-d}{n-i+d-1}$ except if $n - i + d - 1 = 0$ i.e. $i = n + d - 1$, in which case this sum is zero.

We also have that

$$\sum_{\mathcal{F}_v \subset \mathcal{I} \subset \mathcal{F}, \mathcal{I} \neq \mathcal{F}} \delta_{i-2}^{|\bar{\mathcal{I}}|} = \sum_{\bar{\mathcal{I}} \subset \mathcal{F}, \bar{\mathcal{I}} \cap \mathcal{F}_v = \emptyset, \bar{\mathcal{I}} \neq \emptyset} \delta_{i-2}^{|\bar{\mathcal{I}}|}$$

is the number of nonempty subsets of $\mathcal{F} \setminus \mathcal{F}_v$ having $i - 2$ elements. It is $\binom{n-d}{i-2}$ except if $i - 2 = 0$ i.e. $i = 2$, in which case this sum is zero.

Putting all these results together and remarking that $(n - d) - (n - i + d - 1) = i - 2d + 1$, we get the isomorphisms of the Proposition.

The proof of the first part of Proposition 11.2 is completed. Let us now describe the cup product.

Rule 1 is obvious.

To continue, we have to define clearly our sums S_j because they derive from isomorphisms which are, as we shall see right now, not canonical.

Look first at the isomorphism $\tilde{H}_0(P'_{\mathcal{I}_1}, \mathbb{Z}) \simeq \tilde{H}_0(P_{\mathcal{I}}, \mathbb{Z}) \oplus \mathbb{Z}$ where \mathcal{I} is nonempty and does not meet \mathcal{F}_v . This isomorphism is canonical when (not reduced) homology is concerned, but the cycles that are added (multiples of the singleton $\langle v \rangle$) are not cycles in reduced homology. Look now at the isomorphism $\tilde{H}_{d-2}(P'_{\mathcal{I}_2}, \mathbb{Z}) \simeq \tilde{H}_{d-2}(P_{\mathcal{I}}, \mathbb{Z}) \oplus \mathbb{Z}$ where $\mathcal{I} \neq \mathcal{F}$ and contains \mathcal{F}_v . The projection of $\tilde{H}_{d-2}(P'_{\mathcal{I}_2}, \mathbb{Z})$

over $\tilde{H}_{d-2}(P_{\mathcal{I}}, \mathbb{Z})$ is canonical (hence is its kernel which is the factor \mathbb{Z}), but the inclusion of $\tilde{H}_{d-2}(P_{\mathcal{I}}, \mathbb{Z})$ in $\tilde{H}_{d-2}(P'_{\mathcal{I}_2}, \mathbb{Z})$ is not.

Consider a nonempty subset \mathcal{I} of \mathcal{F} disjoint from \mathcal{F}_v . Choose now any reduced homology class in $\tilde{H}_0(P'_{\mathcal{I}_1}, \mathbb{Z})$ whose value on the connected component F of $P'_{\mathcal{I}_1}$ is equal to 1 and call $[c_{\mathcal{I}}]$ this class. It is clear that the groups $\mathbb{Z} \cdot [c_{\mathcal{I}}]$ and $\tilde{H}_0(P_{\mathcal{I}}, \mathbb{Z})$ whose inclusion in $\tilde{H}_0(P'_{\mathcal{I}_1}, \mathbb{Z})$ results from the inclusion $P_{\mathcal{I}} \subset P'_{\mathcal{I}_1}$ give the desired isomorphism. Doing this for every \mathcal{I} , we thus have

$$S_3 = \bigoplus_{\mathcal{I} \subset \mathcal{F}, \mathcal{I} \cap \mathcal{F}_v = \emptyset, \mathcal{I} \neq \emptyset} \mathbb{Z} \cdot [c_{\mathcal{I}}]$$

Consider now $\bar{\mathcal{I}}$. It is a proper subset of \mathcal{F} which contains \mathcal{F}_v . The linking operation on $\tilde{H}_0(P'_{\bar{\mathcal{I}}_1}, \mathbb{Z}) \times \tilde{H}_{d-2}(P'_{\bar{\mathcal{I}}_1}, \mathbb{Z})$ is well defined and the subgroup of the homology classes that are not linked with $[c_{\bar{\mathcal{I}}}]$ is isomorphic to $\tilde{H}_{d-2}(P_{\bar{\mathcal{I}}}, \mathbb{Z})$. As a consequence, $\tilde{H}_{d-2}(P'_{\bar{\mathcal{I}}_1}, \mathbb{Z})$ is the direct sum of this subgroup with the group generated by the class $[c'_{\bar{\mathcal{I}}}]$ of a sphere that "turns around F " (this group is also the kernel of the projection coming from the inclusion $P'_{\bar{\mathcal{I}}_1} \subset P_{\bar{\mathcal{I}}}$). We thus obtain

$$S_4 = \bigoplus_{\mathcal{I} \subset \mathcal{F}, \mathcal{I} \cap \mathcal{F}_v = \emptyset, \mathcal{I} \neq \emptyset} \mathbb{Z} \cdot [c'_{\bar{\mathcal{I}}}]$$

Rule 5 is now clear. More precisely, if we take $[c_{\mathcal{I}}]$ and $[c'_{\bar{\mathcal{J}}}]$ as explained above, the cup product of the corresponding cohomology classes is zero if $\mathcal{I} \neq \bar{\mathcal{J}}$. Indeed, if $\mathcal{I} \neq \bar{\mathcal{J}}$, then $\mathcal{I} \cup \bar{\mathcal{J}} \neq \mathcal{F}$ or $\mathcal{I} \cap \bar{\mathcal{J}} \neq \emptyset$. By Cohomology Theorem 7.6, the cup product is automatically 0 in the first case; and in the second case, it lies in $\tilde{H}_{-1}(\mathcal{I} \cap \bar{\mathcal{J}}, \mathbb{Z})$. As this group is reduced to zero, the cup product is zero too. On the other hand the cup product of the classes associated to $[c_{\mathcal{I}}]$ and $[c'_{\bar{\mathcal{J}}}]$ is, up to sign, the top class of X' (more precise choices allow to obtain exactly the top class every time). This gives rule 5.

For Rule 2, remark first that if both $[c]$ and $[c']$ are in S_j with $j \neq 1$, then the union of the corresponding subsets of $\mathcal{F} \cup \{F\}$ is not all $\mathcal{F} \cup \{F\}$ (indeed F is not in this union if j is 2 or 4 and \mathcal{F}_v does not meet the union if $j = 3$). We then just have to see that $[c] \smile [c']$ vanishes if $j \leq 2$ and $j' \geq 3$.

Consider first a class $[c'_{\bar{\mathcal{J}}}]$ in S_4 . It is realized by a $(d-2)$ -sphere which surrounds F . Remark that every (reduced) homology class in a $P_{\mathcal{I}}$ can be realized by a cycle which is far away from v (except if $\mathcal{I} = \mathcal{F}$ but then the corresponding class is in $H^0(X', \mathbb{Z})$ and rule 1 applies). As F and thus the sphere realizing $[c'_{\bar{\mathcal{J}}}]$ can be thought of very close to v , they do not intersect (neither are they linked). Hence, if $[c']$ is in S_4 and $[c]$ is in $S_{j'}$ with $j' \leq 2$, then $[c] \smile [c'] = 0$.

Consider now a class $[c_{\mathcal{I}}]$ in S_3 . Let $\bar{\mathcal{J}} \neq \mathcal{F}$ and let $[a_{\bar{\mathcal{J}}}]$ be a class of $\tilde{H}_k(P'_{\bar{\mathcal{J}}_2}, \mathbb{Z})$. By arguments similar to those used in the proof of Rule 5, we have that the intersection class $[c_{\mathcal{I}}] \cap [a_{\bar{\mathcal{J}}}]$ corresponds to a non-trivial cohomology class of X' if and only if $[a_{\bar{\mathcal{J}}}]$ is a multiple of $[c'_{\bar{\mathcal{J}}}]$. But such a class is not in S_2 and thus the cup product of a class of S_2 with a class of S_3 is always zero.

Rules 3 and 4 derive from our Theorems 7.6 and 10.1. Assume that F is the greatest element for the order we consider on $\mathcal{F} \cup \{F\}$.

For a proper nonempty subset \mathcal{I} of \mathcal{F} , and an element $[a] \in \tilde{H}_k(P_{\mathcal{I}}, \mathbb{Z})$, recall that $\psi([a])$ is its image in $H^{|\bar{\mathcal{I}}|+d-k-1}(X, \mathbb{Z})$. Let $\psi_i([a]) = \varphi_i(\psi([a]))$ for $i = 1, 2$.

Via our isomorphisms, $[a]$ is identified to some classes $[a_j] \in \tilde{H}_k(P_{\mathcal{I}_j}^t, \mathbb{Z})$ for $j = 1, 2$. Noting ψ' the application on X' which is equivalent to ψ on X , we have $\psi_j([a]) = \psi'([a_j])$ for $j = 1, 2$.

Consider now $[a] \in \tilde{H}_k(P_{\mathcal{I}}, \mathbb{Z})$ and $[b] \in \tilde{H}_{k'}(P_{\mathcal{J}}, \mathbb{Z})$ with \mathcal{I} and \mathcal{J} proper and nonempty. Assume moreover that $\mathcal{I} \cup \mathcal{J} = \mathcal{F}$ (else cup products are zero). Remark that $[a_1] \cap [b_j] = ([a] \cap [b])_j$ for $j = 1, 2$. For a finite set E denote by $K'(E)$ the number $|E| - d + k' - 1$. We then compute:

$$\begin{aligned} \psi_1([a]) \smile \psi_1([b]) &= \psi'([a_1]) \smile \psi'([b_1]) \\ &= \epsilon_{\bar{\mathcal{I}}_1 \bar{\mathcal{J}}_1} (-1)^{(d+1+n+1+K'(\bar{\mathcal{J}}_1)|\bar{\mathcal{I}}_1|)} \psi'([a_1] \cap [b_1]) \end{aligned}$$

and then

$$\begin{aligned} \psi_1([a]) \smile \psi_1([b]) &= - \left(\epsilon_{\bar{\mathcal{I}} \bar{\mathcal{J}}} (-1)^{(d+1+n+K'(\bar{\mathcal{J}})|\bar{\mathcal{I}}|)} \psi'(([a] \cap [b])_1) \right) \\ &= - \varphi_1 \left(\epsilon_{\bar{\mathcal{I}} \bar{\mathcal{J}}} (-1)^{(d+1+n+K'(\bar{\mathcal{J}})|\bar{\mathcal{I}}|)} \psi_1([a] \cap [b]) \right) \\ &= - \varphi_1(\psi([a]) \smile \psi([b])) . \end{aligned}$$

Rule 3 results from this. We also have

$$\begin{aligned} \psi_1([a]) \smile \psi_2([b]) &= \psi'([a_1]) \smile \psi'([b_2]) \\ &= \epsilon_{\bar{\mathcal{I}}_1(\bar{\mathcal{J}}_2)} (-1)^{(d+1+n+1+K'(\bar{\mathcal{J}}_2)|\bar{\mathcal{I}}_1|)} \psi'([a_1] \cap [b_2]) \\ &= (-1)^{1+\bar{\mathcal{I}}} \left(\epsilon_{\bar{\mathcal{I}}(\bar{\mathcal{J}} \cup \{F\})} (-1)^{(d+1+n+K'(\bar{\mathcal{J}})|\bar{\mathcal{I}}|)} \psi'(([a] \cap [b])_2) \right) \\ &= - \left(\epsilon_{\bar{\mathcal{I}} \bar{\mathcal{J}}} (-1)^{(d+1+n+K'(\bar{\mathcal{J}})|\bar{\mathcal{I}}|)} \psi'(([a] \cap [b])_2) \right) \end{aligned}$$

that is

$$\psi_1([a]) \smile \psi_2([b]) = -\varphi_2(\psi([a]) \smile \psi([b])) .$$

Rule 4 results from this. The Proposition is now proved. \square

Example 11.5. Consider the cube as simple polytope. By Corollary 4.6, the associated manifold is the product of three 3-spheres (cf Example 7.9). Cut now a vertex. The resulting simple polytope has dimension 3 and seven facets, hence the associated manifold X has dimension 10. Note also a \mathfrak{S}_3 -symmetry. Let us compute its cohomology ring as an application of Proposition 11.2.

Number 0 the "cut face", 1, 2, 3 the adjacent faces to 0 and 1', 2', 3' the "opposite" faces to 1, 2, 3 respectively.

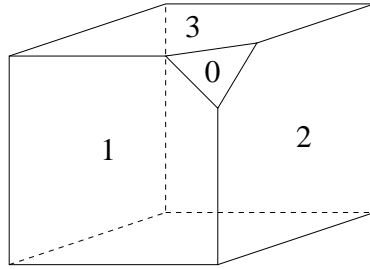

The cohomology groups of X are free and the Betti numbers are:

i	0 ; 10	1 ; 9	2 ; 8	3 ; 7	4 ; 6	5
$b_i(X)$	1	0	0	6	6	2

Denote by λ_i for $1 \leq i \leq 3$ the cohomology classes which generate $H^3(\mathbb{S}^3 \times \mathbb{S}^3 \times \mathbb{S}^3, \mathbb{Z})$, and by λ_{ij} the cup product $\lambda_i \smile \lambda_j$. For $l = 1, 2$ let $\lambda_{i,l}$ (respectively $\lambda_{ij,l}$) be $\varphi_l(\lambda_i)$ (respectively $\varphi_l(\lambda_{ij})$). The expression $e_{\mathcal{I}}$ for some $\mathcal{I} \subset \{0, 1, 2, 3, 1', 2', 3'\}$ denotes the generator of a cohomology class of $P_{\mathcal{I}}$ and will be only used when $P_{\mathcal{I}}$ has only one not zero reduced homology group and when this group is isomorphic to \mathbb{Z} (e.g. $P_{\mathcal{I}}$ has the homotopy type of a circle). Finally, we denote by σ a permutation of the set $\{1, 2, 3\}$. Letting σ varies among the permutations of $\{1, 2, 3\}$, we have:

- $H^3(X, \mathbb{Z})$ is generated by $\lambda_{\sigma(1),1}$ and $e_{123\sigma(1)'\sigma(2)'}$;
- $H^4(X, \mathbb{Z})$ is generated by $\lambda_{\sigma(1),2}$ and $e_{123\sigma(1)'}$;
- $H^5(X, \mathbb{Z})$ is generated by e_{123} and $e_{01'2'3'}$;
- $H^6(X, \mathbb{Z})$ is generated by $\lambda_{\sigma(1)\sigma(2),1}$ and $e_{0\sigma(1)'\sigma(2)'}$;
- $H^7(X, \mathbb{Z})$ is generated by $\lambda_{\sigma(1)\sigma(2),2}$ and $e_{0\sigma(1)'}$.

The product of these generators are zero except:

- i) $\lambda_{\sigma(1),1} \smile \lambda_{\sigma(2),1} = -\lambda_{\sigma(1)\sigma(2),1}$;
- ii) $\lambda_{\sigma(1),1} \smile \lambda_{\sigma(2),2} = -\lambda_{\sigma(1)\sigma(2),2}$ and $\lambda_{\sigma(2),1} \smile \lambda_{\sigma(1),2} = -\lambda_{\sigma(1)\sigma(2),2}$;
- iii) The products which give the top class, i.e. $-(\lambda_{\sigma(1),1} \smile \lambda_{\sigma(2)\sigma(3),2})$, $e_{\mathcal{I}} \smile e_{\bar{\mathcal{I}}}$ and $-(\lambda_{\sigma(1)\sigma(2),1} \smile \lambda_{\sigma(3),2})$.

It is easy to check that, in the previous Example, the cohomology ring of the associated link is isomorphic neither to that of a sphere, nor to that of a connected sum of sphere products, nor to that of the product of such manifolds. The answer to Questions A and A' is thus negative yet in dimension 3. Notice that the exact diffeomorphism type of the link of the previous example is not clear. We may ask

Question : *Describe this manifold more precisely: for instance, can it be decomposed into a connected sum of manifolds?*

In dimension 3, we may in fact characterize precisely which simple polytopes give rise to connected sums of sphere products as links, and which manifolds appear in this way. We have

Proposition 11.6. *Let P be a simple polyhedron (so $d = 3$). Then, the following statements are equivalent:*

- (i) *The cohomology ring of the associated link X is isomorphic to that of a connected sum of sphere products.*
- (ii) *The link X is diffeomorphic to a connected sum of sphere products.*
- (iii) *There exists $l > 0$ such that X is diffeomorphic to*

$$\#_{j=1}^l j \binom{l+1}{j+1} \mathbb{S}^{2+j} \times \mathbb{S}^{6+l-j-1} .$$

- (iv) *There exists $l > 0$ such that P is obtained from the 3-simplex by cutting off l well chosen vertices.*

Proof. By application of Theorem 6.3, we know that (iv) implies (iii), and of course (iii) implies (ii) and (ii) implies (i), so it is sufficient to prove that (i) implies (iv). We assume thus that the cohomology ring of the associated link X is isomorphic to that of a connected sum of sphere products.

Definition 11.7. Let \mathcal{I} be a subset of \mathcal{F} . We say that \mathcal{I} is a 1-cycle of facets of P if $K_{\mathcal{I}}$ is a cycle (i.e. a connected graph all of whose vertices are bivalent).

A 1-cycle of facets can also be viewed as the data of an integer $k \geq 3$ and an injective map from \mathbb{Z}_k into \mathcal{I} such that the images of two elements meet if and only if the two elements are equal or consecutive in \mathbb{Z}_k , and if moreover the k facets do not have a common vertex. The integer k is then called the length of the 1-cycle of facets.

Claim: consider two disjoint facets F and F' of P . Then $\mathcal{F} \setminus \{F, F'\}$ contains a 1-cycle of facets.

To see this, consider the set \mathcal{I}_F of facets that meet F (except F itself). Consider the maps ϕ from \mathbb{Z}_k into \mathcal{I}_F having the following properties:

- i) for all i in \mathbb{Z}_k , $\phi(i)$ meets $\phi(i+1)$.
- ii) for all i in \mathbb{Z}_k , consider the segment on $\phi(i)$ joining the centers of the edges $\phi(i) \cap \phi(i-1)$ and $\phi(i) \cap \phi(i+1)$. We require the polygon obtained by concatenation of all these segments to be nontrivial in the homology of $P_{\partial} \setminus (F \cup F')$.

There exist such maps: order \mathcal{I}_F such that the bijective order-preserving map from $\mathbb{Z}_{|\mathcal{I}_F|}$ to \mathcal{I}_F satisfies i). Then this map also satisfies ii), since the polygon obtained from it is homotopic to the boundary of F . Moreover, let us prove that a minimal subset of \mathcal{I}_F fulfilling these conditions is a 1-cycle of facets.

First, such a minimal subset cannot contain exactly three globally meeting facets, as in this case the polygon considered in the point ii) would be contained in a contractible subset (the union of the three faces) of $P_{\partial} \setminus (F \cup F')$, which is not allowed.

Assume now that in this minimal subset $\{C_1, \dots, C_k\}$, the facet C_1 meet C_j , for some j such that $2 < j < k$. Then $\{C_1, \dots, C_j\}$ and $\{C_1, C_j, C_{j+1}, \dots, C_k\}$ satisfy i) and one of them satisfies ii), as the polygon of C_1, \dots, C_k is homologically the sum of the polygons of these two subsets. Contradiction.

This completes the proof of the claim.

We denote by $(*)$ the property, for a simple 3-dimensional polytope, that all its 1-cycles of facets have length 3.

Assume that P does not satisfy $(*)$. Then we can take a 1-cycle of facets \mathcal{I} of length $k \geq 4$ of P . In particular, I_1 and I_3 are disjoint. The complement of $P_{\mathcal{I}}$ in P has two connected components \mathcal{X} and \mathcal{Y} .

The group $H_1(P_{\mathcal{I}}, \mathbb{Z})$ is isomorphic to \mathbb{Z} , generated by the class of the “polygon” T whose vertices are the centers of the intersections of facets of \mathcal{I} .

Consider now $\mathcal{J} = \{I_1; I_3\} \cup (\mathcal{F} \setminus \mathcal{I})$. The group $H_1(P_{\mathcal{J}}, \mathbb{Z})$ is isomorphic to \mathbb{Z} too, generated by the class of a cycle T' which is decomposed as follows: for $i = 1$ or $i = 3$, let x_i (respectively y_i) be in the intersection of I_i with \mathcal{X} (respectively \mathcal{Y}). Consider a segment in I_i joining x_i to y_i and a path in the interior of \mathcal{X} (respectively \mathcal{Y}) joining x_1 to x_3 (respectively y_1 to y_3). The cycle T' is obtained by the concatenation of these four paths.

The next picture represents such a situation. Here P is the cube with the same numbering of facets as in Example 7.9. The 1-cycle of facets is $\mathcal{I} = \{1, 2, 1', 2'\}$, so $\mathcal{J} = \{1, 3, 1', 3'\}$, whereas $\mathcal{X} = 3$ and $\mathcal{Y} = 3'$.

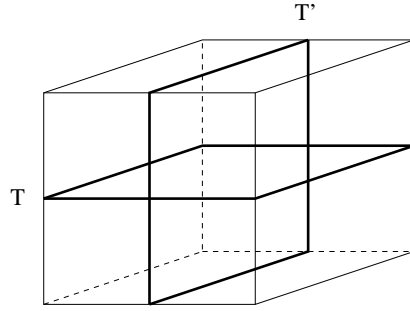

Now $\mathcal{I} \cup \mathcal{J} = \mathcal{F}$ and $\mathcal{I} \cap \mathcal{J} = \{I_1; I_3\}$. On I_3 and on I_1 , the intersection of T and T' is exactly one point. In particular, the intersection class of these two cycles in $H_0(I_1 \cup I_3, \mathbb{Z})$ cannot be zero. By Cohomology Theorem 7.6, the class $\psi([T])$ (respectively $\psi([T'])$) is non-trivial of dimension $|\bar{\mathcal{I}}| + 1$ (respectively $|\bar{\mathcal{J}}| + 1$). Still by Cohomology Theorem 7.6, the cup product $\psi([T]) \smile \psi([T'])$ is a non-trivial cohomology class.

This class does not belong to the top-dimensional cohomology group of X , since the top class corresponds to the generator of $\hat{H}_{-1}(\emptyset, \mathbb{Z})$. This means that the cohomology ring of X is not isomorphic to that of a connected sum of sphere products. Contradiction. The polytope P has only 1-cycles of facets of length 3.

We now have to show the converse, i.e. if P satisfies (*), then P is obtained from the tetrahedron by vertex cutting. Remark that a polyhedron which is obtained from the tetrahedron by vertex cutting has (at least) two disjoint triangular facets (except if it is the tetrahedron itself).

Assume that P has a triangular face. Then, if P is not itself the tetrahedron, we can perform a flip of type (3, 1) along this face so that it disappears. The resulting polytope Q satisfies (*) too as we cannot have created new 1-cycles of facets. It has one face less than P and P is obtained from Q by vertex cutting.

Hence, by induction on the number of facets, we just have to show that a polytope having the property (*) has necessarily a triangular face.

Consider a polytope P fulfilling (*). If P is not a tetrahedron, it has two disjoint facets and, according to the claim, a 1-cycle of facets (F_1, F_2, F_3) of length 3. Now, the plane H passing through the centers of the intersections $F_i \cap F_j$ intersects no other facet. The intersections P^+ and P^- of P with the two half-planes delimited by H are simple convex polytopes satisfying (*) and with a triangular face $H \cap P$. If P^+ is P itself, then P has a triangular face. Else P^+ has strictly less faces than P and, by induction, is obtained from the tetrahedron by vertex cutting. As it cannot be the tetrahedron (because $F_1 \cap F_2 \cap F_3$ is empty), it has two disjoint triangular facets, and in particular one which is disjoint from $H \cap P$. This facet is also a triangular facet of P , which completes the proof. \square

In higher dimension, the simple polytopes obtained from the simplex (of same dimension) by cutting off vertices still give rise to links whose cohomology ring is isomorphic to that of a connected sum of products of spheres by Theorem 6.3. Nevertheless, there are not the only ones and a nice characterization of all the polytopes having this property seems not to exist. In particular, the results of [LdM2] recalled in Example 0.5 give examples of connected sums of products of spheres which cannot be obtained by Theorem 6.3. We use the notations of Example

0.5. Set $n = 10$ and $n_1 = \dots = n_5 = 2$. Then, the associated link X is diffeomorphic to $\#(5)\mathbb{S}^7 \times \mathbb{S}^{10}$. Since X is 6-connected, it is not diffeomorphic to one of the links obtained by Theorem 6.3: none of them is 3-connected. Moreover, we may construct other examples. To do that, recall that a (n even dimensional) polytope is called neighbourly if every subset of cardinal $\frac{d}{2}$ determines a face, and that such a polytope is simplicial (see Section 2 and [Gr]). A polytope whose dual is neighbourly is therefore simple and is called a dual neighbourly polytope. Here, we will only consider the even dimensional case.

Proposition 11.8. *Assume that P is dual neighbourly and of even dimension. Then the cohomology ring of X is isomorphic to the one of a connected sum of sphere products.*

Proof. We try to compute the reduced homology groups of $P_{\mathcal{I}}$, for \mathcal{I} proper and nonempty. Recall that this set is homotopy equivalent to the subcomplex of P^* corresponding to the *maximal* subcomplex whose vertices are those related to the facets of \mathcal{I} . For $k < \frac{d}{2} - 1$, the $k + 1$ -skeleton of $P_{\mathcal{I}}^*$ is complete by definition of neighbourliness, hence $P_{\mathcal{I}}$ has trivial reduced k -(co)homology.

The torsion part of $\tilde{H}_{\frac{d}{2}-1}(P_{\mathcal{I}}, \mathbb{Z})$ is isomorphic to the torsion part of the group $\tilde{H}_{\frac{d}{2}}(P_{\mathcal{I}}, \mathbb{Z})$. From Lemma 7.4 and Alexander-Pontrjagin duality (see [Al], t. 3, p.53), it is also isomorphic to the torsion part of the group $\tilde{H}_{\frac{d}{2}-2}(P_{\mathcal{I}}, \mathbb{Z})$, hence is trivial. In the same way, for $k \geq \frac{d}{2}$, the group $\tilde{H}_k(P_{\mathcal{I}}, \mathbb{Z})$ is isomorphic to the direct sum of the free part of $\tilde{H}_{d-k-2}(P_{\mathcal{I}}, \mathbb{Z})$ and of the torsion part of $\tilde{H}_{d-k-3}(P_{\mathcal{I}}, \mathbb{Z})$, both being trivial.

To sum up, the reduced homology groups of $P_{\mathcal{I}}$ vanish except in dimension $\frac{d}{2} - 1$ in which case it is free.

Furthermore, if the homology intersection of two such classes is nonzero, then it must lie in the reduced homology group of dimension -1 of some subset of \mathcal{F} , which must be the emptyset. Finally, to conclude, we just have to see that the linking number is a unimodular bilinear form on $\tilde{H}_{\frac{d}{2}-1}(P_{\mathcal{I}}, \mathbb{Z}) \times \tilde{H}_{\frac{d}{2}-1}(P_{\mathcal{I}}, \mathbb{Z})$, which results from the "little Pontrjagin duality" (see [Al], t. 3, p.91).

This proves the lemma. \square

Example 11.9. The (even dimensional) cyclic polytopes ([Gr], §4.7) are examples of neighbourly polytopes. For any d and any $v \geq d + 1$, there exists a unique cyclic polytope $C(d, v)$ of dimension d with v vertices. Let us take $d = 4$. Then $C(4, 5)$ is the 4-simplex, while $C(4, 6)$ is dual to the product of two triangles. Using the Dehn-Sommerville equations ([Gr], Chapter 9), it is easy to check that $C(4, 7)$ has 28 faces of dimension 2 and that $C(4, 8)$ has 40 such faces. Comparing these numbers with the number of 2-faces of the 6-simplex and of the 7-simplex, this means that, in $C(4, 7)$, there exist 7 subsets \mathcal{I} such that $P_{\mathcal{I}}^*$ is not contractible but homotopic to a circle, and, in $C(4, 8)$, there exist 16 such subsets. Using the homology formula of Remark 7.7, Proposition 11.8 and Lemma 0.10, we get easily the following table.

v	5	6	7	8
X	\mathbb{S}^9	$\mathbb{S}^5 \times \mathbb{S}^5$	$\#(7)\mathbb{S}^5 \times \mathbb{S}^6$	$\#(16)\mathbb{S}^5 \times \mathbb{S}^7 \#(15)\mathbb{S}^6 \times \mathbb{S}^6$

In the first three cases, the table gives the diffeomorphism type of X ; in the third case, this follows from the fact that the same example can be obtained from

Example 0.5 (take $n = k = 7$ and use Lemma 1.3). On the contrary, it guarantees only the cohomology ring of X in the last case. Notice that this last case can be obtained neither from Theorem 6.3 nor from Example 0.5.

This leads to the conjecture:

Conjecture. *If P is dual neighbourly, then X is actually the connected sum of sphere products (if not a sphere).*

Remark 11.10. One difficult step in proving the conjecture is to prove that, if P is dual neighbourly, then X has the homotopy type of a connected sum of sphere products. Relating to this is the more general question

Question. *Let X and X' be two links. Assume that they have isomorphic cohomology rings. Are they homotopy equivalent?*

We will go back to this question in Part III.

To finish with this part, we have to answer Question A". Indeed, a link may not only have torsion in (co)homology, but arbitrary torsion!

Torsion Theorem 11.11. *The (co)homology groups of a 2-connected link may have arbitrary amount of torsion. More precisely, let G be any abelian finitely presented group. Then, there exists a 2-connected link X such that $H^i(X, \mathbb{Z})$ contains G as a free summand (that is $H^i(X, \mathbb{Z}) = G \oplus \dots$) for some $2 < i < \dim X - 2$.*

This is a very surprising result (at least for the authors) since the links are transverse intersections of quadrics with very special properties ...

Proof. Let G be an abelian finitely presented group. Let K be a finite simplicial complex such that $\tilde{H}_i(K, \mathbb{Z}) = G$ for some $i > 0$. Let $\{1, \dots, l\}$ be the vertex set of K . Consider the $(l - 1)$ -simplex and let its set of facets be $\{1, \dots, l\}$. For every simplex $I = (i_1, \dots, i_p)$ of maximal dimension of K , cut off the face of the $(l - 1)$ -simplex numbered $\{1, \dots, l\} \setminus I$ by a generic hyperplane. We thus obtain a simple convex polytope P . Notice that its number of facets n is the sum of l with the number f of facets of K . Set $\mathcal{F} = \{1, \dots, l, l + 1, \dots, l + f\}$. Finally, consider the associated link X .

The crucial remark is that $link_{\Delta} \sigma_{\{l+1, \dots, l+f\}}$ is isomorphic to K . Indeed, by Remark 7.11, we have

$$link_{\Delta} \sigma_{\{l+1, \dots, l+f\}} = \{I \subset \{1, \dots, l\} \mid F_{\hat{I}} = \emptyset\} .$$

Now, $F_{\hat{I}}$ is empty if and only if \hat{I} numbers a face of the $(l - 1)$ -simplex which is cut off when passing to P , i.e. if and only if I numbers a simplex of K . By application of Cohomology Theorem 7.6 and Lemma 7.12, every (reduced) homology group of K will thus appear as a free summand of some cohomology group of X . So will appear G . \square

Remark 11.12. The proof of this Theorem is perhaps easier to understand when modified as follows. Starting with a finite simplicial complex K with l vertices, embed it as a simplicial subcomplex of the $(l - 1)$ -simplex Δ . Perform a barycentric subdivision of each face of $\Delta \setminus K$. We thus obtain a simplicial polytope P^* such that K is the maximal simplicial subcomplex of P^* of vertex set $\{1, \dots, l\}$. We conclude with Remark 7.7.

The proof of Torsion Theorem 11.11 is constructive. Here is an example.

Example 11.13 (compare with [Je]). Consider the minimal triangulation of the projective plane $\mathbb{P}^2(\mathbb{R})$ drawn at the bottom of this example. The simplices of maximal dimensions are

$$\{(356), (456), (246), (235), (145), (125), (134), (234), (126), (136)\}$$

Consider the 5-simplex and number its facets $\{1, \dots, 6\}$. Cut off the faces of this simplex numbered

$$\{(123), (124), (135), (146), (156), (236), (245), (256), (345), (346)\}$$

by generic hyperplanes. We thus obtain a simple 5-polytope with 16 facets giving rise to a 2-connected link X of dimension 21. Set $\mathcal{F} = \{1, \dots, 16\}$. The complex $\text{link}_{\Delta} \sigma_{\{7, \dots, 16\}}$ is homotopic to the projective plane. By Lemma 7.12, this means that $\tilde{H}_1(P_{\{7, \dots, 16\}}, \mathbb{Z})$ is isomorphic to \mathbb{Z}_2 . Cohomology Theorem 7.6 implies that

$$\begin{aligned} H^9(X, \mathbb{Z}) &\simeq \bigoplus_{\mathcal{I} \subset \{1, \dots, 16\}} \tilde{H}_{|\mathcal{I}|-5}(P_{\mathcal{I}}, \mathbb{Z}) \\ &\simeq \tilde{H}_1(P_{\{7, \dots, 16\}}, \mathbb{Z}) \oplus \dots \simeq \tilde{H}_1(\mathbb{P}^2(\mathbb{R}), \mathbb{Z}) \oplus \dots \simeq \mathbb{Z}_2 \oplus \dots \end{aligned}$$

Therefore, not all the homology groups of X are free.

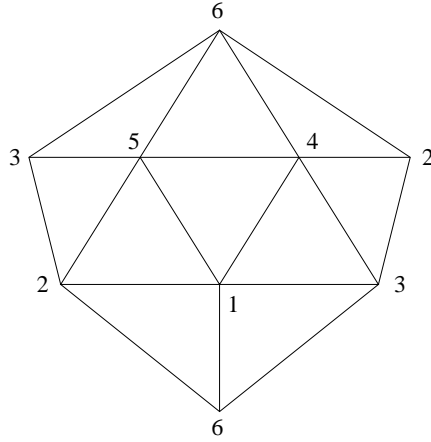

Notice that, due to Corollary 11.1, the dimension of this counterexample is sharp.

PART III: APPLICATIONS TO COMPACT COMPLEX MANIFOLDS

12. LV-M manifolds and links

We recall very briefly the construction of the LV-M manifold (see [Me1] and [Me2] for more details; this is a generalization of the construction presented in [LdM-Ve]). Let $m > 0$ and $n > 2m$ be two integers. Let $\Lambda = (\Lambda_1, \dots, \Lambda_n)$ be a set of n vectors of \mathbb{C}^m satisfying the Siegel and the weak hyperbolicity condition (as vectors of \mathbb{R}^{2m} , see Lemma 0.3). Consider the holomorphic foliation \mathcal{F} of the projective space \mathbb{P}^{n-1} given by the following action

$$(20) \quad (T, [z]) \in \mathbb{C}^m \times \mathbb{P}^{n-1} \longmapsto [\exp\langle \Lambda_1, T \rangle \cdot z_1, \dots, \exp\langle \Lambda_n, T \rangle \cdot z_n] \in \mathbb{P}^{n-1}$$

where the brackets denote the homogeneous coordinates in \mathbb{P}^{n-1} and where $\langle -, - \rangle$ is the *inner* product of \mathbb{C}^n . Define

$$(21) \quad V = \{[z] \in \mathbb{P}^{n-1} \mid 0 \in \mathcal{H}((\Lambda_i)_{i \in I_z})\}$$

where I_z was defined in (1). We notice that the set I_z is independent of the choice of a representant z of the class $[z]$. Finally define

$$(22) \quad \mathcal{N}_\Lambda = \{[z] \in \mathbb{P}^{n-1} \mid \sum_{i=1}^n \Lambda_i |z_i|^2 = 0\}$$

which is a smooth manifold due to the weak hyperbolicity condition (see Lemma 0.3).

Then it is proven in [Me1] (see also [Me2]) that

- (i) The restriction of \mathcal{F} to V is a regular foliation of dimension m .
- (ii) The compact smooth submanifold \mathcal{N}_Λ is a global transverse to \mathcal{F} restricted to V , that is cuts every leaf transversally in an unique point.

Therefore, \mathcal{N}_Λ can be identified with the quotient space of \mathcal{F} restricted to V and thus inherits a complex structure. We will denote N_Λ the compact complex manifold obtained in this way. A complex manifold N_Λ for some Λ will be called a *LV-M manifold*. Notice that it has (complex) dimension $n - m - 1$.

The main complex properties of these manifolds are investigated in [Me1], where as a particularly nice connection with projective toric varieties is explained in [Me2]. We will not need these results, but we will use the following Lemma. Recall that Λ_i is an *indispensable point* if 0 is not in the convex hull of $(\Lambda_j)_{j \neq i}$.

Lemma 12.1. *Let N_Λ be a LV-M manifold. Assume that Λ has at least $m + 1$ indispensable points. Then the complex structure of N_Λ is affine (and even linear), that is may be defined by a holomorphic atlas such that the changes of charts are affine (and even linear) automorphisms of \mathbb{C}^{n-m-1} .*

Proof. Assume that $\Lambda_1, \dots, \Lambda_{m+1}$ are indispensable. By (21), this implies

$$[z] \in V \Rightarrow z_1 \cdot \dots \cdot z_{m+1} \neq 0$$

By construction of N_Λ , we just need to construct a foliated atlas of (V, \mathcal{F}) with linear transverse changes of charts. Look at the map

$$(T, w) \in \mathbb{C}^m \times \mathbb{C}^{n-m-1} \xrightarrow{\Phi_z} [z_1 \cdot \exp\langle \Lambda_1, T \rangle, \dots, z_{m+1} \cdot \exp\langle \Lambda_{m+1}, T \rangle, \\ w_1 \cdot \exp\langle \Lambda_{m+2}, T \rangle, \dots, w_{n-m-1} \cdot \exp\langle \Lambda_n, T \rangle] \in V$$

for a fixed set $z = (z_1, \dots, z_{m+1}) \in (\mathbb{C}^*)^{m+1}$. Using the weak hyperbolicity condition, it can be shown that the set $(\Lambda_2 - \Lambda_1, \dots, \Lambda_{m+1} - \Lambda_1)$ has rank m . As a consequence, $\Phi_z(T, w) = \Phi_{z'}(T', w')$ if and only if

$$w'_i = w_i \cdot \exp \langle \Lambda_{m+1+i}, T - T' \rangle \quad 1 \leq i \leq n - m - 1$$

and $T - T'$ belongs to a fixed lattice in \mathbb{C}^m . Therefore Φ_z is a local homeomorphism and can be used as a local foliated chart for every point (z_1, \dots, z_{m+1}, w) . Since the $(m + 1)$ first homogeneous coordinates of every point of V are not zero, V can be covered by such charts. Moreover, the previous computation proves that the changes of charts are uniquely determined by translations along a lattice $T \mapsto T + a$ so that the transverse changes of charts have the form

$$w \in \mathbb{C}^{n-m-1} \mapsto (w_1 \cdot \exp \langle \Lambda_{m+2}, a \rangle, \dots, w_{n-m-1} \cdot \exp \langle \Lambda_n, a \rangle)$$

that is are linear. \square

To avoid particular cases in the sequel, we add the special case $m = 0$: then there is no action at all and N is by definition the projective space \mathbb{P}^{n-1} .

Let $A \in \mathcal{A}$. The quotient space of X_A by the diagonal action (6) can be identified with

$$(23) \quad \tilde{X}_A = \{[z] \in \mathbb{P}^{n-1} \mid \sum_{i=1}^n A_i |z_i|^2 = 0\}$$

which is a smooth manifold by Lemma 0.3. In particular, if X_A is not simply-connected, then by Lemma 0.9, it is equivariantly diffeomorphic to $X_B \times \mathbb{S}^1$ for some $B \in \mathcal{A}$. It is then easy to check that X_B and \tilde{X}_A are equivariantly diffeomorphic. On the contrary, when $A \in \mathcal{A}_0$, the manifold \tilde{X}_A is not a link: for example, think about the case where X_A is diffeomorphic to $\mathbb{S}^3 \times \mathbb{S}^3$ (Example 0.4).

The following Theorem is the motivation for the previous study of the links.

Theorem 12.2. *Let $A \in \mathcal{A}$ of dimensions p and n . Then,*

- (i) *If p is odd, that is if X_A is even-dimensional, then X_A admits a complex structure as a LV-M manifold.*
- (ii) *If p is even, that is if X_A is odd-dimensional, then \tilde{X}_A and $X_A \times \mathbb{S}^1$ admit a complex structure as a LV-M manifold.*

Proof. Assume that X_A is odd-dimensional, that is that p is even. Setting $m = p/2$ and letting Λ denote the image of A via the standard identification between \mathbb{C}^m and \mathbb{R}^{2m} , then \tilde{X}_A and \mathcal{N}_Λ are the same. Therefore, \tilde{X}_A inherits a complex structure.

If p is odd, define the following matrix with $n + 1$ columns and $p + 1$ rows

$$B = \begin{pmatrix} & A & 0 \\ 1 & \dots & 1 & -1 \end{pmatrix}$$

This is obviously an admissible configuration and by Lemma 0.9, the links X_B and $X_A \times \mathbb{S}^1$ are equivariantly diffeomorphic. As noticed before, this means that \tilde{X}_B is diffeomorphic to X_A and we are in the previous case.

Finally, if p is even, consider the following matrix with dimensions $n + 2$ and $p + 2$

$$C = \begin{pmatrix} A & 0 & 0 \\ 1 \dots 1 & -1 & 0 \\ 1 \dots 1 & 0 & -1 \end{pmatrix}$$

Then X_C is equivariantly diffeomorphic to $X_A \times \mathbb{S}^1 \times \mathbb{S}^1$, and $\tilde{X}_C \underset{eq}{\sim} X_A \times \mathbb{S}^1$ has a complex structure as a LV-M manifold by what precedes. \square

Corollary 12.3. *The product of two links admits a complex structure as a LV-M manifold as soon as it has even dimension.*

Proof. Use Example 0.6 and Theorem 12.2, (i). \square

Remark 12.4. Let $A \in \mathcal{A}$ and let $A' \in \mathcal{A}$ be obtained from A by a homotopy which does not break the weak hyperbolicity condition. Then, by Corollary 4.5, the links X_A and $X_{A'}$ are equivariantly diffeomorphic. Nevertheless, the complex structures of X_A and $X_{A'}$ (if p is odd) or of \tilde{X}_A and $\tilde{X}_{A'}$ (if p is even) given by Theorem 12.2 are in general not the same; in this way a link X_A or its diagonal quotient \tilde{X}_A comes equipped not only with a complex structure but with a deformation space of complex structures (see [Me1] where this space is studied).

13. Holomorphic wall-crossing

Let N_Λ be a LV-M manifold. Identifying \mathbb{R}^{2m} to \mathbb{C}^m and Λ to an element of \mathcal{A} , we may talk of a wall W of Λ (see Definition 5.2) and of a configuration Λ' obtained from Λ by crossing the wall W (Definition 5.3). Up to equivariant diffeomorphism, $N_{\Lambda'}$ is obtained from N_Λ by performing an equivariant smooth surgery described in Wall-crossing Theorem 5.4. Nevertheless, N_Λ and $N_{\Lambda'}$ being complex manifolds, it is natural to ask which *holomorphic* transformation occurs when performing the wall-crossing. This is what we call the *holomorphic wall-crossing problem*.

Remark 13.1. Let $B \in \mathbb{C}^m$ such that $\Lambda' = \Lambda + B$, that is $\Lambda' = (\Lambda_1 + B, \dots, \Lambda_n + B)$. By Definition 5.3, the configuration $\Lambda + tB$ is admissible for every $t \in [0, 1]$, except for one special value t_0 . It follows from (20) and from Corollary 4.5 that N_Λ and $N_{\Lambda+tB}$ are biholomorphic for every $0 \leq t < t_0$ and that $N_{\Lambda'}$ and $N_{\Lambda+tB}$ are biholomorphic for every $t_0 < t \leq 1$ (compare with the general case of Remark 12.4). Therefore, the complex structures of the induced links are fixed before and after crossing the wall.

In this Section, we will give a complete solution to the holomorphic wall-crossing problem by showing that, in this case, the smooth equivariant surgeries occurring during the wall-crossing are in fact holomorphic surgeries. Let us first recall

Definition 13.2 (see [M-K], p.15). Let M be a complex manifold and let S be a holomorphic submanifold of M . Let W be a neighborhood of S . Finally let $S^* \subset W^*$ be a pair (holomorphic submanifold, complex manifold) such that W^* is a neighborhood of S^* . Given a biholomorphism $f : W \setminus S \rightarrow W^* \setminus S^*$, we may construct the well-defined complex manifold M^* by cutting S and pasting S^* by use of f . We say that M^* is obtained from M by a *holomorphic surgery* along (S, W, S^*, W^*, f) .

Notice that if f' is smoothly isotopic to f , the result of performing a holomorphic surgery along (S, f') is diffeomorphic but in general not biholomorphic to M^* .

Holomorphic wall-crossing Theorem 13.3. *Let N_Λ be a LV-M manifold. Let $N_{\Lambda'}$ be a LV-M manifold obtained from N_Λ by crossing a wall. Then $N_{\Lambda'}$ is obtained from N_Λ by a holomorphic surgery.*

Proof. Let X_F be the smooth submanifold of N_Λ along which the elementary surgery occurs. Using Section 1 and the standard identification of \mathbb{R}^{2m} and \mathbb{C}^m , we have that X_F is the quotient space of the foliation \mathcal{F} restricted to

$$V \cap \{z_i = 0 \mid i \in I\}$$

for the subset $I \subset \{1, \dots, n\}$ numbering X_F (see (11)). Therefore it is a holomorphic submanifold of N_Λ corresponding to the admissible subconfiguration $(\Lambda_i)_{i \in I^c}$. By abuse of notations, we still call X_F this complex manifold. On the other hand, we have $V' = V$ and the submanifold $X'_{F'}$ is the quotient space of \mathcal{F}' restricted to the same $V \cap \{z_i = 0 \mid i \in I\}$. Define $W = V \setminus \{z_i = 0 \mid i \in I\}$. As Λ and Λ' differ only by a translation factor, the open complex manifolds $W/\mathcal{F} = N_\Lambda \setminus X_F$ and $W/\mathcal{F}' = N_{\Lambda'} \setminus X'_{F'}$ are biholomorphic. More precisely, the identity map of W descends to a biholomorphism f between these two complex manifolds. As a consequence, $N_{\Lambda'}$ is obtained from N_Λ by a holomorphic surgery along $(X_F, N_\Lambda, X'_{F'}, N_{\Lambda'}, f)$. \square

Remark 13.4. The holomorphic surgery described in the proof of Theorem 13.3 is a very particular case of Definition 13.2, since the neighborhood W of the submanifold X_F is in fact the whole manifold N_Λ . It is thus a global holomorphic transformation, whereas Definition 13.2 has a local flavour. It is perhaps better to say that N_Λ and $N_{\Lambda'}$ are holomorphic compactifications of the same open complex manifold $N_\Lambda \setminus X_F = N_{\Lambda'} \setminus X'_{F'}$.

14. Topology of LV-M manifolds

As an application of Torsion Theorem 11.11, we have

Theorem 14.1. *The (co)homology groups of a 2-connected LV-M manifold may have arbitrary amount of torsion. More precisely, let G be any abelian finitely presented group. Then, there exists a 2-connected LV-M manifold N_Λ such that $H^i(N_\Lambda, \mathbb{Z})$ contains G as a free summand (that is $H^i(N_\Lambda, \mathbb{Z}) = G \oplus \dots$) for some $2 < i < 2n - 2m - 4$.*

Proof. Apply Torsion Theorem 11.11 to obtain a 2-connected link X with this property. If X is even-dimensional, then we may conclude by Theorem 12.2. Otherwise, we perform a surgery of type $(1, n)$ on $X \times \mathbb{S}^1$. By Proposition 11.2, the resulting 2-connected link X' still has the property that G is a free summand of one of its cohomology groups. But now X' is even-dimensional and we conclude by Theorem 12.2. \square

Remark 14.2. As a consequence of a result of [Ta], every finitely presented group may appear as the fundamental group of a compact complex non-kählerian 3-fold. The previous Theorem is a sort of (much) weaker version of this result for higher dimensional homology groups. Notice that it is not known if a similar statement is true for Kähler manifolds.

Before drawing an interesting consequence of this Theorem, we want to go back to the question asked in Remark 11.10. The “holomorphic” version of this question is

Question. *Let N and N' be two LV-M manifolds. Assume that they have isomorphic cohomology rings. Are they homotopically equivalent?*

In the case of two *Kähler* manifolds, the answer to this question is yes: two Kähler manifolds with isomorphic cohomology rings are indeed homotopically equivalent (see [D-G-M-S]). For non-Kähler manifolds, the answer is not in general. Counterexamples exist yet in dimension two. Consider the open manifold

$$W = \{(w_1, w_2, w_3) \in \mathbb{C}^3 \setminus \{(0, 0, 0)\} \mid w_1^2 + w_2^3 + w_3^5 = 0\}$$

The quotient space of W by the group generated by a well-chosen weighted homothety is a compact complex surface which is diffeomorphic to $\Sigma \times S^1$, where Σ is the Poincaré sphere (see [B-VdV] and [Mi]). Thinking about the Hopf surfaces, this means that both $S^3 \times S^1$ and $\Sigma \times S^1$ admit complex structures. Now they have isomorphic cohomology rings but different homotopy type (since the Poincaré sphere is not simply-connected).

It seems plausible that the techniques of [D-G-M-S] can be applied to the non-Kähler class of LV-M manifolds and would bring a positive answer to the question.

Going back to Theorem 14.1, we obtain easily the following surprising Corollary:

Corollary 14.3. *The (co)homology groups of a 2-connected compact complex affine manifold may have arbitrary amount of torsion (in the sense of Theorem 14.1).*

Proof. By use of Theorem 14.1 and Lemma 12.1, it is enough to prove that, given a LV-M manifold N_Λ of dimensions (m, n) , there exists a LV-M manifold $N_{\Lambda'}$ of dimensions (m', n') such that

- (i) The manifold $N_{\Lambda'}$ is diffeomorphic to a product of N_Λ by circles.
- (ii) The number of indispensable points of $N_{\Lambda'}$ is $m' + 1$.

Let Λ_l be the matrix with $n + 2l$ rows

$$\begin{pmatrix} \Lambda_1 & \dots & \Lambda_n & 0 & \dots & 0 \\ -1 - i & \dots & -1 - i & 1 & i & \dots & 0 & 0 \\ \vdots & & \vdots & & \ddots & & & \\ -1 - i & \dots & -1 - i & & & & 1 & i \end{pmatrix}$$

It is straightforward to check that Λ_l is admissible, that it has $2l$ indispensable points, and that N_{Λ_l} is diffeomorphic to $N_\Lambda \times (\mathbb{S}^1)^{2l}$ (see Example 0.6). The equality $m' + 1 = 2l$ is achieved for $l = m + 1$. \square

This means that it is not possible to classify affine complex manifolds or complex manifolds having a holomorphic affine connection up to diffeomorphism. Notice that an affine compact *Kähler* manifold is covered by a compact complex torus (see [K-W]).

The previous proof suggests to ask the following question.

Question. *Let M be a compact complex manifold. Under which assumptions on M does the smooth manifold $M \times (\mathbb{S}^1)^{2N}$ admit a complex affine structure for N sufficiently large? Is it enough to assume that the total Stiefel-Whitney class and the total Pontrjagin class of M are equal to one?*

We emphasize that the searched complex affine structure on $M \times (\mathbb{S}^1)^{2N}$ does not need to respect M , that is we do not require that M may be embedded as a holomorphic submanifold of $M \times (\mathbb{S}^1)^{2N}$ endowed with its affine complex structure.

Every compact Riemann surface satisfies the conditions of the second part of the question. Since only the elliptic curves admit affine complex structures, the question is interesting and non-trivial even in dimension one. Every compact complex surface which is spin and has signature zero satisfies the conditions of the second part of the question. Other examples are given by complex manifolds with stably parallelizable smooth tangent bundle (i.e. such that the Whitney sum of the smooth tangent bundle with a trivial bundle of sufficiently large rank is trivial). Indeed, this is exactly the case for a link X_A , since it is smoothly embedded in \mathbb{C}^n with trivial normal bundle, so that

$$TX_A \oplus E^{p+1} = T\mathbb{R}^{2n}$$

where TM denotes the tangent bundle of a smooth manifold M and where E^k denotes the trivial bundle over X_A with fibre \mathbb{R}^k .

Notice that the condition on the characteristic classes is necessary. For, if $M \times (\mathbb{S}^1)^{2N}$ admits a complex affine structure, then the total Chern class of this structure is one (see [K-W]), which implies the same property for the total Stiefel-Whitney and Pontrjagin classes of $M \times (\mathbb{S}^1)^{2N}$. But these classes coincide with the total Stiefel-Whitney and Pontrjagin classes of M . In particular, for any $n > 1$ and for any $N \geq 0$, the smooth manifold $\mathbb{P}^n \times (\mathbb{S}^1)^{2N}$ does not admit any complex affine structure by computation of its Pontrjagin total class (see [M-S], Example 15.6).

REFERENCES

- [Al] P.S. Aleksandrov, *Combinatorial Topology*, 3 tomes, Graylock, Rochester, 1956.
- [B-L] M.M. Bayer, C.W. Lee, *Combinatorial aspects of convex polytopes*, Handbook of convex geometry, Elsevier Sciences Publishers B.V., 1993, pp. 485–534.
- [B-VdV] E. Brieskorn, A. Van de Ven, *Some complex structures on products of homotopy spheres*, *Topology* **7** (1968), 389–393.
- [B-P] V.M. Buchstaber, T.E. Panov, *Torus actions and their applications in topology and combinatorics*, AMS, Providence, 2002.
- [Bo] F. Bosio, *Variétés complexes compactes : une généralisation de la construction de Meersseman et López de Medrano-Verjovsky*, *Ann. Inst. Fourier* **51** (2001), 1259–1297.
- [Br] G.E. Bredon, *Introduction to Compact Transformation Groups*, Academic Press, New York and London, 1972.
- [C-E] E. Calabi, B. Eckmann, *A class of compact, complex manifolds which are not algebraic*, *Ann. of Math.* **58** (1953), 494–500.
- [C-K-P] C. Camacho, N. Kuiper, J. Palis, *The topology of holomorphic flows with singularity*, *Publ. math. IHES* **48** (1978), 5–38.
- [D-J] M.W. Davis, T. Januszkiewicz, *Convex polytopes, Coxeter orbifolds and torus actions*, *Duke Math. J.* **62** (1991), 417–451.
- [D-G-M-S] P. Deligne, P. Griffiths, J. Morgan, D. Sullivan, *Real homotopy theory of Kähler manifolds*, *Invent. Math.* **29** (1975), 245–274.
- [DL] M. de Longueville, *The ring structure on the cohomology of coordinate subspace arrangements*, *Math. Z.* **233** (2000), 553–577.
- [Fu] W. Fulton, *Introduction to toric varieties*, Princeton University Press, Princeton, NJ, 1993.
- [G-McP] M. Goresky, R. Mac Pherson, *Stratified Morse theory*, Springer, Berlin, 1988.
- [Gr] B. Grünbaum, *Convex polytopes*, Interscience, New York, 1967.
- [Hi] M. W. Hirsch, *Differential Topology*, Springer, Berlin, 1976.
- [Ho] H. Hopf, *Zur Topologie der komplexen Mannigfaltigkeiten*, Studies and essays presented to R. Courant, New York, 1948.
- [Je] K. Jewell, *Complements of sphere and subspace arrangements*, *Topo. and its appl.* **56** (1994), 199–214.
- [K-W] S. Kobayashi, H. Wu, *Complex Differential Geometry*, Birkhäuser, Basel, 1983.
- [LdM1] S. López de Medrano, *The space of Siegel leaves of a holomorphic vector field*, *Lecture Notes in Mathematics* **1345** (1988), 233–245.
- [LdM2] S. López de Medrano, *The topology of the intersection of quadrics in \mathbb{R}^n* , *Lecture Notes in Mathematics* **1370** (1989), 280–292.
- [LdM-Ve] S. López de Medrano, A. Verjovsky, *A new family of complex, compact, non symplectic manifolds*, *Bol. Soc. Mat. Bra.* **28**, **2** (1997), 253–269.
- [M-K] J. Morrow, K. Kodaira, *Complex manifolds*, Athena series, Holt, Rinehart and Winston, 1971.
- [McG] D. Mac Gavran, *Adjacent connected sums and torus actions*, *Trans. of the AMS* **251** (1979), 235–254.
- [McM] P. MacMullen, *On simple polytopes*, *Invent. Math.* **113** (1993), 419–444.
- [Me1] L. Meersseman, *A new geometric construction of compact complex manifolds in any dimension*, *Math. Ann.* **317** (2000), 79–115.
- [Me2] L. Meersseman, A. Verjovsky, *Holomorphic principal bundles over toric projective varieties*, *J. reine angew. Math.* (to appear).
- [Mi] J. Milnor, *On the 3-dimensional Brieskorn manifolds $M(p, q, r)$* , *Knots, groups and 3-manifolds*, Princeton Univ. Press, Princeton, NJ, 1975, pp. 175–225.
- [M-S] J.W. Milnor, J.D. Stasheff, *Characteristic classes*, *Annals of Mathematics Studies*, vol. 76, Princeton University Press, Princeton, NJ, 1974.
- [Ta] C.H. Taubes, *The existence of anti-selfdual conformal structures*, *J. Diff. Geom.* **36** (1992), 163–253.
- [Ti] V.A. Timorin, *An analogue of the Hodge-Riemann relations for simple convex polytopes*, *Russian Math. Surveys* **54** (1999), 381–426.

UNIVERSITÉ DE POITIERS
UFR SCIENCES SP2MI
DÉPARTEMENT DE MATHÉMATIQUES
BOULEVARD MARIE-ET-PIERRE-CURIE
TÉLÉPORT 2-BP 30179
86962 FUTUROSCOPE CHASSENEUIL CEDEX
FRANCE
E-mail address: `Frederic.Bosio@math.univ-poitiers.fr`

LAURENT MEERSSEMAN
I.R.M.A.R.
UNIVERSITÉ DE RENNES I
CAMPUS DE BEAULIEU
35042 RENNES CEDEX
FRANCE
E-mail address: `laurent.meersseman@univ-rennes1.fr`