



HAL
open science

Silica nanoparticles separation from water: aggregation by cetyltrimethylammonium bromide (CTAB)

Yanping Liu, Mallorie Tourbin, Sébastien Lachaize, Pascal Guiraud

► **To cite this version:**

Yanping Liu, Mallorie Tourbin, Sébastien Lachaize, Pascal Guiraud. Silica nanoparticles separation from water: aggregation by cetyltrimethylammonium bromide (CTAB). *Chemosphere*, 2013, vol. 92 (6), pp. 681-687. 10.1016/j.chemosphere.2013.03.048 . hal-00875884

HAL Id: hal-00875884

<https://hal.science/hal-00875884>

Submitted on 23 Oct 2013

HAL is a multi-disciplinary open access archive for the deposit and dissemination of scientific research documents, whether they are published or not. The documents may come from teaching and research institutions in France or abroad, or from public or private research centers.

L'archive ouverte pluridisciplinaire **HAL**, est destinée au dépôt et à la diffusion de documents scientifiques de niveau recherche, publiés ou non, émanant des établissements d'enseignement et de recherche français ou étrangers, des laboratoires publics ou privés.



Open Archive TOULOUSE Archive Ouverte (OATAO)

OATAO is an open access repository that collects the work of Toulouse researchers and makes it freely available over the web where possible.

This is an author-deposited version published in : <http://oatao.univ-toulouse.fr/>
Eprints ID : 9756

To link to this article : DOI: 10.1016/j.chemosphere.2013.03.048
URL : <http://dx.doi.org/10.1016/j.chemosphere.2013.03.048>

<p>To cite this version : Liu, Yanping and Tourbin, Mallorie and Lachaize, Sébastien and Guiraud, Pascal Silica nanoparticles separation from water: aggregation by cetyltrimethylammonium bromide (CTAB). (2013) Chemosphere, vol. 92 (n° 6). pp. 681-687. ISSN 0045-6535</p>

Any correspondence concerning this service should be sent to the repository administrator: staff-oatao@listes-diff.inp-toulouse.fr

Silica nanoparticles separation from water: Aggregation by cetyltrimethylammonium bromide (CTAB)

Y. Liu^{a,b,c,1}, M. Tourbin^{a,b,c,2}, S. Lachaize^{d,e}, P. Guiraud^{a,b,c,*}

^a Université de Toulouse, INSA, UPS, INP, LISBP, 135 Avenue de Rangueil, F-31077 Toulouse, France

^b INRA, UMR792 Ingénierie des Systèmes Biologiques et des Procédés, F-31400 Toulouse, France

^c CNRS, UMR5504, F-31400 Toulouse, France

^d Université de Toulouse, INSA, UPS, LPCNO, 135 Avenue de Rangueil, F-31077 Toulouse, France

^e CNRS, LPCNO, F-31077 Toulouse, France

H I G H L I G H T S

- The same CCC was gained at $M(\text{CTAB}) = 0.1 \text{ mmol L}^{-1}$ for different 30R50 concentrations.
- More than 95.7% of turbidity can be removed for 30R50 0.15% with CTAB 0.1 mmol L^{-1} .
- The “hydrophobic effect” plays an important role in aggregation of 30R25.
- The results show different agglomeration mechanisms.

A B S T R A C T

Nanoparticles will inevitably be found in industrial and domestic wastes in the near future and as a consequence soon in water resources. Due to their ultra-small size, nanoparticles may not only have new hazards for environment and human health, but also cause low separation efficiency by classical water treatments processes. Thus, it would be an important challenge to develop a specific treatment with suitable additives for recovery of nanoparticles from waters. For this propose, this paper presents aggregation of silica nanoparticles (Klebosol 30R50 (75 nm) and 30R25 (30 nm)) by cationic surfactant cetyltrimethylammonium bromide (CTAB). Different mechanisms such as charge neutralization, “depletion flocculation” or “volume-restriction”, and “hydrophobic effect” between hydrocarbon tails of CTAB have been proposed to explicate aggregation results. One important finding is that for different volume concentrations between 0.05% and 0.51% of 30R50 suspensions, the same critical coagulation concentration was observed at $\text{CTAB} = 0.1 \text{ mM}$, suggesting the optimized quantity of CTAB during the separation process for nanoparticles of about 75 nm. Furthermore, very small quantities of CTAB (0.01 mM) can make 30R25 nanosilica aggregated due to the “hydrophobic effect”. It is then possible to minimize the sludge and allow the separation process as “greener” as possible by studying this case. It has also shown that aggregation mechanisms can be different for very small particles so that a special attention has to be paid to the treatment of nanoparticles contained in water and wastewaters.

Keywords:
Separation
Nanoparticles
CTAB
Water
Aggregation
Silica

1. Introduction

For the past decade, nanotechnology industries start to come on line with larger scale production, it is then inevitable that nano-

scale products and by-products will reside at some level in our recreational and drinking waters (Daughton, 2004; Moore, 2006; Weinberg et al., 2011). From accidental spillages or permitted release of industrial effluents, nanoparticles could accumulate into the human body via skin contact, inhalation of water aerosols, direct ingestion of contaminated drinking water, or indirect exposure from ingestion of vegetables and aquatic organisms such as fish, molluscs and crustaceans as a part of the human diet (Daughton, 2004; Brar et al., 2010).

Although research on risks of nanoparticles is still limited compared to their plentiful applications, hazards relevant to humans and animals health begin to be listed or investigated (Reijnders,

* Corresponding author at: Université de Toulouse, INSA, UPS, INP, LISBP, 135 Avenue de Rangueil, F-31077 Toulouse, France. Tel.: +33(0)561559686; fax: +33(0)561559760.

E-mail addresses: yanping.liu@univ-amu.fr (Y. Liu), mallorie.tourbin@ensiacet.fr (M. Tourbin), sebastien.lachaize@insa-toulouse.fr (S. Lachaize), pascal.guiraud@insa-toulouse.fr (P. Guiraud).

¹ Laboratoire de Procédés Propres et Environnement, Europôle de l'Arbois-Pavillon Laënnec BP80, 13545 Aix en Provence Cedex 4, France.

² Laboratoire de Génie Chimique, 4 Allée Emile Monso, F-31432 Toulouse, France.

2006). In fact, the very large surface area of these small particles can result in the direct generation of harmful oxyradicals; that can cause cell injuries. Furthermore, the ability of the nanoparticles to penetrate the body and cells provides potential routes for the delivery of nanoparticle-associated toxic pollutants to sites where they would not normally go (Moore, 2006). Nanoparticles can then behave like a vector on which hazardous compounds are concentrated.

Nanoparticles differ from classical solid particles by their size, smaller by several orders of magnitude, and their specific properties due to their high surface area over volume ratio. These differences could be responsible for a low efficiency of classical water treatment processes. Thus, it is reasonable to begin considering suitable treatment for water and wastewaters containing synthetic nanoparticles that may present novel toxicity.

One important issue was to determine nanoparticle's types for which the development of water treatments seems to be urgent or the most economically interesting. Today, we used to classify nanoparticles via already known properties, the easiest being their chemical composition. Three main categories are usually distinguished: (a) pure metallic nanoparticles (Fe, Ag, Au, ...), (b) metallic oxides or oxy-hydroxides (SiO_2 , TiO_2 , ...), (c) carbonaceous nanoparticles (nanotubes, fullerenes, ...). Among them, SiO_2 and TiO_2 nanoparticles are already produced in very large quantities (10^2 – 10^3 t yr⁻¹) (Ostiguy et al., 2006).

In China and Taiwan, silica nanoparticles are very commonly used as abrasive in chemical mechanical polishing (CMP) industries for the manufacture of integrated circuits and electronic chips (Chin et al., 2006). The studies of several research groups (Lai and Lin, 2003; Hu et al., 2005; Chin et al., 2006; Kin et al., 2006; Lien and Liu, 2006; Yang and Tsai, 2006; Tsai et al., 2007) give a better idea of their composition after an analysis of some samples. To sum up, suspensions are mainly composed of silica particles, with an important total solid content (1.3–8.5 g L⁻¹ which corresponds to 0.05–0.36 vol.%) and an average size around 100 nm. These suspensions show a negative charge on particles surface, and the zeta potential $|\zeta|$ remains lower than 30 mV leading to their stability. In addition, although silica particles are usually not considered as dangerous even at the nanoscale, other pollutants such as heavy metals in the suspensions may be concentrated and taken by nanosilica into the human body. Summarily, the availability of data concerning these largely produced effluents, as well as the existence of commercially available products necessary for research purposes, confers to SiO_2 nanoparticles the quality of interesting candidate for developing wastewater treatment processes.

Another important issue in the framework is the development of specific treatments (e.g. coagulation, flotation or filtration...) and suitable additives (if necessary) for water containing nanoparticles. Recently, Bizi (2012) has investigated the coagulation and flocculation of nanosilica by some organic polymers. The treatment of CMP effluents by chemical coagulation with polyaluminium chloride has been studied by Chang et al. (2007). Their structural study of the agglomeration of the nanoparticles due to the coagulation demonstrated the interest of the addition of coagulant for a better recovery of the nanoparticles. However, this conventional coagulation–flocculation treatment used in CMP industries could cause a bulky sludge (Arvanitoyannis, 2008). Then, in the last years some papers refer to flotation processes eventually combined with coagulation for the CMP wastewater treatment.

Hu et al. (2005) and Lien and Liu (2006) have performed coagulation–flotation process by using a cationic surfactant cetyltrimethylammonium bromide (CTAB), to address the treatment of CMP wastewater. In their works, CTAB has been proved helpful to enhance the removal of the turbidity thanks to the aggregation of particles. The addition of CTAB could also greatly reduce the sludge volume after coagulation–flotation process comparing with

coagulation–flocculation by cationic polymers; and no CTAB pollution problem existed after their treatments.

We have consequently focused our study on the understanding of the aggregation of nano- SiO_2 by CTAB for the following reasons: (1) CTAB which is composed of a cationic polar head and a hydrophobic tail could aggregate negatively charged nanosilica by both surface charge neutralization and/or by hydrophobic effect from the long hydrocarbon tail; these two effects together or alone would make the silica particles less stable and aggregate (Bryleva et al., 2007); (2) the coagulation–flotation process, which would be our final choice for the treatment of water containing nanoparticles, seems to be “greener” due to less quantities of sludge (Hu et al., 2005); and it has been confirmed in our tests that the addition of CTAB can greatly increase the flotation efficiency for silica nanoparticles, but the combination of the homo-coagulation between nanoparticles and the hetero-coagulation between nanoparticles and bubbles enhanced the complication of the basic research; thus this preliminary study only refers to the aggregation of nano- SiO_2 by CTAB in order to better control coagulation process during the further coagulation–flotation study; (3) since CTAB has been used to reduce bubble size and increase collective efficiency in the flotation process for a long time (Hanna, 1975; Hu et al., 2003), it would benefit the following flotation study concerning nanoparticles separation.

This work concerns to the investigation of CTAB additions to nanosilica suspensions. The quantity of CTAB is varied. The zeta potential, the particle size distribution and the turbidity of the suspension are measured. This investigation is performed for two sizes of SiO_2 nanoparticles.

2. Materials and methods

Klebosol 30R50 and 30R25 colloidal silica suspensions that have different sizes and the same initial solid content of about 15.3 vol.% were purchased from Rohm and Haas Electronic Materials, France. The stability of these manufactured suspensions was obtained by the producer through the addition of Na_2O (< 0.2%) which generated anionic nano- SiO_2 surface; particles would thus repel each other, providing a good stability to the colloid. The diluted suspensions (0.05–0.51 vol.%) were prepared with deionized water produced from the urban system, where raw water is filtered to 1 μm , then demineralised by ion exchange resins. The conductivity of the deionized water is 1.7 $\mu\text{S cm}^{-1}$ in average, comparing with that of raw water is 270 $\mu\text{S cm}^{-1}$. The surface tension of water is 0.072 N m⁻¹ at 25 °C (Huang, 2009).

The size of the Klebosol 30R50 and 30R25 nanoparticles was measured by transmission electron microscopy (TEM, Philips CM20 (200 kV) and JEOL 100 CX), and dynamic light scattering (DLS) (Nanotrak, Microtrac). The size analysis of nano- SiO_2 /CTAB/water systems was done by laser diffraction (Mastersizer 2000, Malvern Instruments) for the reason that the size of aggregates might not remain in the range of DLS measurement.

The ζ of diluted suspensions was measured by electrophoresis with a Zetasizer NanoZS (Malvern Instruments). pH was measured at ambient temperature with a pH-539 pH-meter (WTW) and a SenTix 41 pH-electrode, and turbidity was measured with a 2100N-IS Turbidimeter (Hach).

CTAB \geq 98% (Carl Roth GmbH KG) was used as the additive for the aggregation of silica nanoparticles. The surface tension of CTAB and water was determined by 3S Tensiometer (GBX), and the conductivity was determined by a LF 538 conductivity meter (WTW).

The preparation of aggregated samples was to add certain quantities of CTAB (powder) into certain quantities of nanosilica suspensions in order to have the concentration range of CTAB from 0.01 to 100 mM. The range of nanoparticles was from 0.05% to

0.51% in volume, corresponding from 1.2, 3.6 and 12 g L⁻¹ respectively. The sample volume was from 25 to 250 mL.

After an immediate agitation by hand, these samples were let to deposit until they reach the equilibrium (no more changes of turbidity in their supernatants). The equilibrium time for different nano-SiO₂/CTAB/water systems was different from less than 5 min in the most favorable conditions. The equilibrium time lasted up to 2 wk for unfavorable conditions. Indeed, for samples that would well aggregate, the coagulation process started immediately after the mixture of CTAB and SiO₂ suspensions, and the equilibrium time was less than 5 min. The size distribution of these well aggregated samples always showed aggregation without remaining nanoparticles. In other word, they showed only one peak of aggregation. However, for other samples that had two peaks (one for nanoparticles, the other for aggregation), the equilibrium time might last until 2 wk. The samples for laser diffraction analysis were collected after agitation of the samples (mixture of the liquid suspensions with the previously settled aggregates).

The Krafft temperature or critical micelle temperature of CTAB, which is the minimum point below which the CTAB remains in crystalline form, measured by Carolina and Barney (2003) is about 25 °C. Therefore, all results of CTAB and nano-SiO₂/CTAB/water systems were prepared and measured at a temperature higher than 25 °C in order to be sure that the powder of CTAB was sufficiently dissolved in solution.

3. Results and discussion

3.1. Characterizations of nanoparticle suspensions

The detailed characterization has been presented in Liu et al. (2012); here we just make a brief summary. The nanosilica suspensions Klebosol 30R50 and 30R25 are respectively 50 and 25 nm determined by BET (commercial data from the manufacturer). They are firstly observed by TEM and then validated by DLS. From TEM, two populations in 30R50 suspensions have been observed: larger ones about 80–85 nm in diameter and smaller ones about 30–40 nm; while for 30R25 from TEM, particles are most monodispersed, and the average size is about 35–40 nm. The mean diameters measured by the Nanotracer (DLS) at SiO₂ concentration 0.15 vol.% are respectively 75 and 30 nm for 30R50 and 30R25.

ζ of the particles was measured in order to predict the suitable conditions for the removing process since it is mainly controlled by the interfacial forces. For the initial silica suspensions 30R50 and 30R25, the very high and negative ζ measured (in absolute value $|\zeta| \geq 30$ mV) confirmed that the stability of the system was insured by the repulsive interaction. It is worth noting that no aggregation of 30R50 and 30R25 was observed by changing pH (2–11), whatever their final ζ values (between –35 and –2 mV), so the pH of samples were not adjusted to one specific value in the following aggregation study.

3.2. Characterization of CTAB

The critical micelle concentration (CMC) is the concentration of surfactants above which micelles are spontaneously formed. In our experiments, the conductivity and surface tension were used to determine the CMC of CTAB which value was about 0.92 ± 0.05 mM. Modaressi et al. (2007) have reported the CMC of CTAB at 0.89 mM, while Gao et al. (2004) have cited 0.92 mM, and Maiti et al. (2000) have given 0.8 mM; the CMC measured in this work is then comparable with the results of others.

Table 1 gives conductivity, turbidity and pH of different CTAB concentrations. For Klebosol 30R50 suspensions (0.05–0.51%), the turbidity is respectively 61.9, 171 and 542 NTU; and for Klebosol 30R25 suspensions (0.05–0.51%), the turbidity is respectively 4.0,

Table 1
The properties of CTAB in water.

Concentration (mmol L ⁻¹)	Conductivity (μs cm ⁻¹)	Turbidity (NTU)	pH
0	1.1	0.056	6.65
0.01	2.1	0.05	6.54
0.1	11.2	0.07	6.51
1	94.9	0.095	6.13
10	301	0.185	5.55
100	2230	0.81	5.55

8.0 and 20.6 NTU. The turbidity values of CTAB concentrations (see Table 1) are much smaller than those of the nanosilica suspensions, indicating that the extra CTAB would not change the turbidity of nano-SiO₂/CTAB/water systems in the supernatant liquid after aggregation and sedimentation. Thus, turbidity that is an indication of the clarity of water mainly relates to the sizes and the numbers of particles could be used as a measuring technique for the monitoring of the colloidal nanoparticles concentration along the treatment process. In order to further verify a potential effect of these micelles or molecules on the size measurements, we have measured the sizes of solutions at different CTAB concentrations (0.01–100 mM). Their sizes measured by both DLS and laser diffraction could not be detected whatever the CTAB concentration, certainly due to the fact the size of the CTAB micelles remains very small. So we are confident in considering that the micelles of CTAB would not influence the measurement of aggregation. Moreover, CTAB is easily dissociated into cationic CTA⁺ and bromide ion and its speciation is not influenced by the pH changes (Lien and Liu, 2006).

3.3. Surface modification and aggregation of silica nanoparticles by CTAB

3.3.1. Aggregation of nanosilica 30R50 with CTAB

Fig. 1 gives the ζ and pH profiles of 30R50 (0.15%) at different concentrations of CTAB. The adsorption of CTAB (0.01–100 mM) modifies the silica surface (ζ) from negatively to positively charged. The isoelectric point for 30R50 0.15% is at about CTAB = 0.1 mM. Size distributions of these samples are further shown in Fig. 2. All measurements were done after reaching the equilibrium; otherwise the results would be changed continuously.

While adding CTAB 0.01 and 100 mM to 30R50 (0.15%), the size distributions of these two samples are nearly the same as 30R50

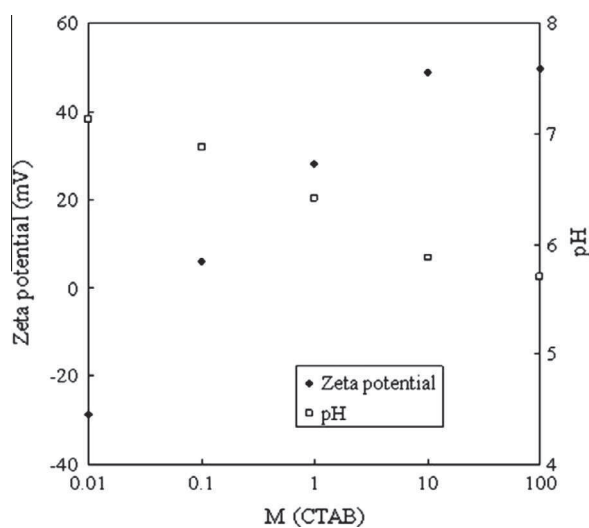

Fig. 1. Zeta potential and pH profiles of the 30R50 (0.15%) at different concentrations of CTAB (0–100 mM).

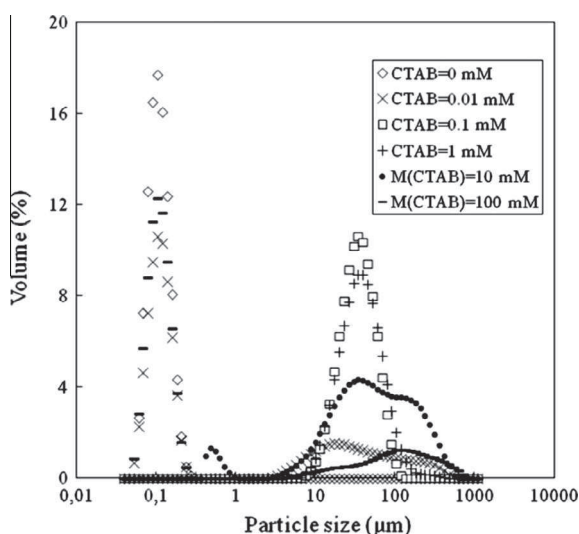

Fig. 2. Size distributions of the 30R50 (0.15%) at different concentrations of CTAB (mM) analyzed by laser diffraction.

0.15% without CTAB, except a few aggregates of 10–1000 μm observed. This result suggests that CTAB 0.01 mM might be too low to induce an efficient aggregation, and most of the silica nanoparticles are still stable and separated, in agreement with the $\zeta \approx -30$ mV. At CTAB 100 mM, no obvious aggregation can be observed from Fig. 2. The $\zeta = 46$ mV implies the formation of a bilayer of CTAB molecules at the silica surface, leading to the stabilization of the nanoparticles suspension by positive surface charges; but the possibility of micelles formation could not be eliminated, since 100 mM far exceeds the CMC (0.92 ± 0.05 mM) of CTAB. From Fig. 2, CTAB 0.1 and 1 mM give better aggregation results and very few silica nanoparticles stay in solution after aggregation. In these conditions, $\zeta < 30$ mV also characterizes a probable aggregation. However, when $\text{CTAB} = 10$ mM, the aggregates exist at $\zeta > 30$ mV, this special phenomenon will be explicated in the following. We have to remember that, as shown in Liu et al. (2012), the observed aggregation is not due to the change in pH.

It could be proposed that the interactions between silica nanoparticles and CTAB act as follows: small quantities of CTAB could firstly act in a monolayer formation that is controlled by electrostatic interaction between positively charged surfactant head-groups and siloxane groups ($-\text{SiO}^-$) on the nanosilica surface. Furthermore, it is well known that adsorption of CTAB on silica surface could overcome the micelles formation in bulk water (Bi et al., 2003; Bryleva et al., 2007). This may be the reason why even if the CTAB concentrations are near or higher than the CMC, a good aggregation can still be obtained.

However, when the concentration of CTAB is much higher than the CMC (e.g. 100 mM), whatever the concentration of 30R50, as it will be shown in the next part, the bilayer owing to hydrophobic interaction between surfactant hydrocarbon tails could be formed, leading to the restabilization of nano- $\text{SiO}_2/\text{CTAB}/\text{water}$ systems. Fig. 3 describes the possible interactions between CTAB and nanosilica particles. It is worth noting that charge neutralization seems to be the major reason of 30R50 nanosilica aggregation, but hydrophobic effect from hydrocarbon tails of CTAB may contribute to the aggregation as well.

3.3.2. Effect of particle concentration on aggregation of nanosilica 30R50 by CTAB

The aggregation of 30R50 0.05% and 0.51% by CTAB was further explored in order to investigate the effect of different nanoparticles concentrations. Fig. 4a shows zeta potential and particle size pro-

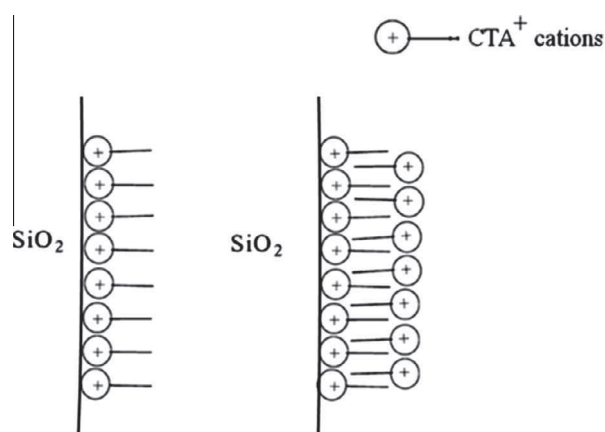

Fig. 3. Simplified scheme of CTAB mono- and bilayers on $\text{SiO}_2/\text{water}$ interface, when the CTAB concentration increases; counterion Br^- is omitted for clarity (suggested by Bryleva et al., 2007).

files of 30R50 (0.05% and 0.51%) at different concentrations of CTAB, in which only average sizes of aggregates were presented. For the aggregation of 30R50 0.05%, when $\text{CTAB} = 0.1$ mM, corresponding to $|\zeta| < 30$ mV, efficient aggregation can be obtained. When $\text{CTAB} = 0.01$ and 100 mM, only a few aggregates form probably due to high surface charge of particles ($|\zeta| > 30$ mV); but when $\text{CTAB} = 1$ and 10 mM ($\zeta > 30$ mV), aggregates still exist under the

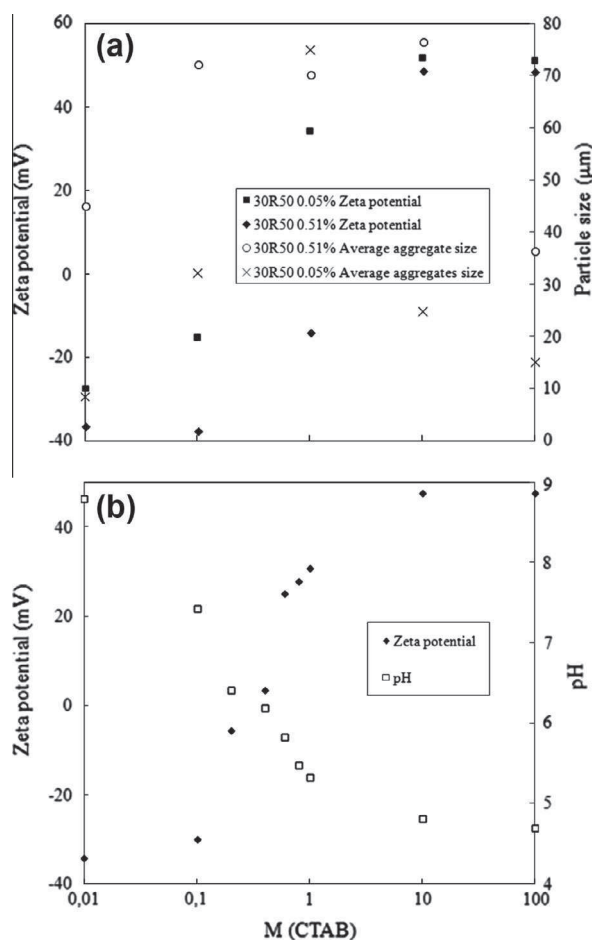

Fig. 4. (a) Zeta potential and particle size profiles of 30R50 (0.05% and 0.51%) at different concentrations of CTAB (mM). (b) Zeta potential and pH profiles of the 30R25 (0.15%) at different concentrations of CTAB (mM).

condition of high ζ (> 30 mV). This phenomenon is almost the same as that of 3OR50 0.15% with CTAB = 10 mM and neither of them can be explained by the charge neutralization.

For aggregation of 3OR50 0.51%, not only CTAB = 10 mM ($\zeta > 30$ mV) can make nanosilica particles form aggregates, but also the CTAB = 0.1 mM ($\zeta < -30$ mV). Better aggregation results are found for CTAB = 0.1 to 10 mM, but 0.01 and 100 mM CTAB can also form a few aggregates of silica nanoparticles.

Overall, the aggregation is observed at CTAB = 10 mM ($\zeta > 30$ mV) for all three concentrations of 3OR50, while it should have a stable state according to zeta potential prediction. It is likely that another mechanism called “depletion” or “volume-restriction” (Furusawa et al., 2002) contributes to the aggregation at high concentrations of CTAB. As the concentration of CTAB 10 mM is much larger than its CMC (0.92 ± 0.05 mM), the formation of micelle could not be avoided. When two particles approach in a solution within free micelles of CTAB, hydrocarbon chains leave the gap, generating a local region with almost pure solvent. The osmotic pressure in the fluid surrounding the particle pair exceeds that between the particles and may force the particles together (Furusawa et al., 2002).

Moreover, it was also observed that all of the satisfying aggregation of 3OR50 (0.05–0.51%) begin at CTAB = 0.1 mM, whatever their surface zeta potential. This suggests that the “depletion flocculation” may not only occur at very high zeta values (10 mM CTAB for all three concentrations of 3OR50 as mentioned above), but also very low ones (3OR50 0.51% with 0.1 mM CTAB corresponding to $\zeta \approx -40$ mV). Of course, at the concentration of 0.1 mM CTAB, the formation of micelles from CTAB can be neglected. However, as nanoparticles come closer together, the intercolloidal region consists of a region that is depleted in CTAB. The depletion effect (Shi, 2002) is induced by their osmotic pressure, due to the difference of CTAB concentration between the inside and outside regions. Solvent between the nanoparticles then tends to diffuse out to reduce the concentration gradient, causing the nanoparticles to aggregate.

Table 2 shows the turbidity of different nano-SiO₂/CTAB/water systems. For all of the samples, the turbidity of the solution increased as soon as the CTAB was added, but only for some of them, the ones that could give efficient aggregation and sedimentation, the turbidity (taken in the supernatant liquid) subsequently decreased below the original turbidity of the 3OR50 suspensions. For example, the sample 3OR50 (0.15%) with CTAB 0.1 mM lost more than 96% of turbidity after aggregation and sedimentation compared with the original value (171 NTU). Moreover, these better aggregated samples can also reach their final turbidity in a short time (less than 5 min), but the samples without efficient aggregations have to wait from 5 min to 2 wk to get their final and relatively stable turbidity.

In conclusion, for the aggregation of 3OR50 (0.05–0.51%) with CTAB, charge neutralization mechanism could be sometimes overcome by “depletion flocculation”, but finally the same (0.1 mM

Table 2

The turbidity (NTU) of different suspensions of nanosilica 3OR50 with different concentrations of CTAB.

M(CTAB) (mM)	3OR500.05%	3OR500.15%	3OR500.51%
0	61.9	171	542
0.01	78.6	464	757
0.1	2.1	7.4	703
1	23.3	84.7	80.3
10	250	491	– ^a
100	88.3	274	– ^a

^a As the 2100N-IS Turbidimeter cannot measure the turbidity more than 1000 NTU, “–” was used to stand for values higher than 1000 NTU.

CTAB) is the lowest concentration tested that induces aggregation of the system. This result would give a better knowledge to develop environmentally friendly separation technology such as coagulation–flotation in order to minimize the sludge, as well as the optimized quantity of CTAB for the treatment of water containing silica nanoparticles with a diameter of about 75 nm; but for nanosilica with smaller size such as 3OR25, the suggestion may no longer fit.

3.3.3. Effect of size: aggregation of nanosilica 3OR25 with CTAB

The aggregation of 3OR25 0.15% with different concentrations of CTAB was studied to compare with that of 3OR50 0.15%. Fig. 4b gives the properties of 3OR25 0.15% with CTAB, from which CTAB = 0.01–100 mM corresponding to $|\zeta| \approx 30$ mV or $|\zeta| > 30$ mV would stabilize 3OR25 nanoparticles according to the zeta potential prediction.

However, from Fig. 5, all of these samples form aggregates. Nearly no nanoparticles remain in the suspensions after aggregation and sedimentation except in the one with CTAB = 100 mM. This phenomenon can be explained neither by charge neutralization nor by “depletion flocculation”, because the aggregates exist at very low CTAB concentrations (0.01 mM). Nevertheless, as the particle size is about 30 nm for 3OR25, the aggregation by hydrophobic chains interaction between surfactant hydrocarbon tails is more likely to happen. Based on DLVO theory, the stability of a particle in solution is dependent upon its total potential energy function V_T :

$$V_T = V_A + V_R \quad (1)$$

where V_A is the van der Waals interaction energy, and V_R is the electrostatic repulsion energy. For the van der Waals interaction between two particles, theoretical derivation starts with the assumption that the particle separation distance D is much larger compared to the two particle radii a . For spherical particles, the van der Waals interaction energy can be expressed as:

$$V_A = -\frac{Aa}{12D} \quad (2)$$

where A is the Hamaker constant, $A = 8.3 \times 10^{-21}$ J (Kobayashi et al., 2005).

The electrostatic repulsion energy is:

$$V_R = 2\pi\epsilon_0\epsilon_r a^2 \zeta^2 \ln[1 + \exp(-\kappa D)] \quad (3)$$

where π is the solvent permeability, ϵ_0 is the permittivity of free space (8.854×10^{-12} F m⁻¹), ϵ_r is the dielectric constant of the suspension medium and is approximately 78.4 for an aqueous system at 20 °C and κ is a function of the ionic composition (Lu, 2007):

$$\kappa = \left(\frac{e^2 N_A \sum c_i z_i^2}{\epsilon_0 \epsilon_r k_B T} \right)^{\frac{1}{2}} \quad (4)$$

where e is electron charge, N_A is Avogadro's number, c is the molar concentration of ions, z is the valence of each ion and k_B is Boltzmann's constant (1.381×10^{-23} J k⁻¹), T is the temperature.

Fig. 6 gives DLVO prediction of particle size effect on particle interaction for 3OR50 and 3OR25 suspensions based on the calculations from Eqs. (1)–(4), in which particle concentration is 0.15 vol.%; [Na₂O] = 0.2% w/w; [H⁺] and [OH⁻] in the suspensions were calculated from the zeta potential (–35 mV for 3OR50 and –30 mV for 3OR25) and pH measurement (pH = 6.83 for 3OR50 and 8.76 for 3OR25); $A = 8.3 \times 10^{-21}$ J (Kobayashi et al., 2005).

According to the theory calculation, the barrier of interaction energy between 3OR25 nanoparticles is smaller than that of 3OR50. It is then more possible for the hydrocarbon tails of adsorbed CTAB to touch each other and then aggregate 3OR25 nanosilica.

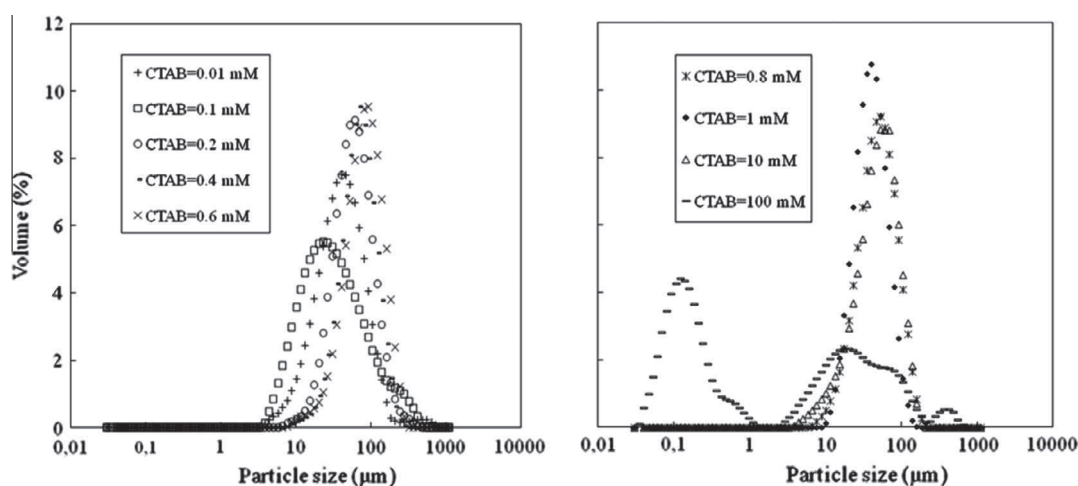

Fig. 5. Size distributions of the 30R25 (0.15%) at different concentrations of CTAB (0.01–100 mM) analyzed by laser diffraction.

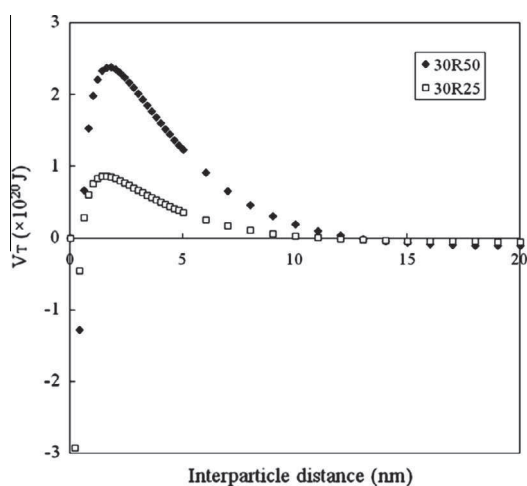

Fig. 6. DLVO prediction of particle size effect on particle interaction for 30R50 and 30R25 suspensions.

Fig. 7 is a possible scheme of the 30R25 0.15% aggregation. As the concentration of CTAB increases, the Klebosol 30R25 would undergo four steps. When a little quantity of CTAB is adsorbed on the silica surface, the repulsion between negatively charged surface reduces, but it may not be enough to destabilize the suspension (step 1, this step could present at CTAB < 0.01 mM). As increasing the quantity of CTAB, the negative surface charge of 30R25 could further reduce. The aggregation may occur even before complete charge neutralization, owing to hydrophobic interaction of CTAB (step 2). By continuously increasing the quantity of CTAB, the silica surface would be neutralized, even altered to be positive, and the hydrophobic interaction could still act on the aggregation (step 3). Lastly, when the CTAB concentration is high enough, a bilayer of CTAB could envelop the particle surface and thus restabilize the nanosilica suspension (step 4).

To sum up, “hydrophobic effect” from the hydrocarbon tail of CTAB seems to play an important role in the aggregation of 30R25. For all concentrations of CTAB investigated, there were always aggregations of 30R25. It is then possible to add very small quantities of CTAB for the treatment of water containing nanosilica of about or less than 30 nm in diameter, which may allow the separation process much more eco-friendly.

4. Conclusion

After a review of a few papers dealing with the potential hazards of nanoparticles released in the water resources, we observe that it would be an important challenge for the recovery of nanoparticles from water in the near future. Our work is then focused on the separation of nanoparticles from waters. Industrial waste waters containing silica nanoparticles have already been identified and their treatment by coagulation and sedimentation needs a large amount of additives. Flotation with CTAB as additive seems to be a promising treatment alternative because of a lower quantity of sludges, but the use of CTAB for flotation also generates silica aggregation, in competition with bubble-nanoparticle heterocoagulation. Thus, in this paper, the aggregation of silica nanoparticles by CTAB was investigated. Coagulation mechanisms of silica nanoparticles with CTAB have been proposed. From the results, charge neutralization is the main mechanism for the aggregation of 30R50 suspensions. At low CTAB concentration such as CTAB = 0.01 mM, the negative surface charge of the nanoparticles was not affected enough, so the silica nanoparticles usually remained stable. On the contrary, if the CTAB concentration was much above the CMC, a bilayer of CTAB would be formed and restabilize the silica nanoparticles by positive surface charge. Other mechanism such as “depletion flocculation” or “volume-restriction” was proposed to explain the aggregation of nanosilica at high $|\zeta|$ conditions.

It has been found that for different particle concentrations (0.05–0.51%) of 30R50 suspensions, 0.1 mM CTAB is the lowest concentration tested that induced aggregation of the system. More than 96% of the turbidity can be removed after aggregation and sedimentation for the sample 30R50 0.15% with CTAB 0.1 mM, suggesting efficient separation of nanosilica from water at this CTAB dosage. Moreover, in our previous study (Liu et al., 2012) on SiO₂ nanoparticle separation from water by aggregation with AlCl₃, more than 99% of the turbidity could be removed after sedimentation, but sometimes this process was time-consuming due to the hydrolysis of AlCl₃; while the aggregation of SiO₂ nanoparticle with CTAB consumes shorter time (5 min in the most favorable conditions) to have turbidity removal efficiency more than 96%. Compared with experiments carried out by Zhang et al. (2008) that at an alum dosage of 60 mg L⁻¹, coagulation of TiO₂, ZnO, Fe₂O₃, NiO and SiO₂ commercial nanoparticles followed by sedimentation could remove 20–60% of the total nanoparticle mass, it seems to be more reasonable to aggregate SiO₂ nanoparticles by CTAB.

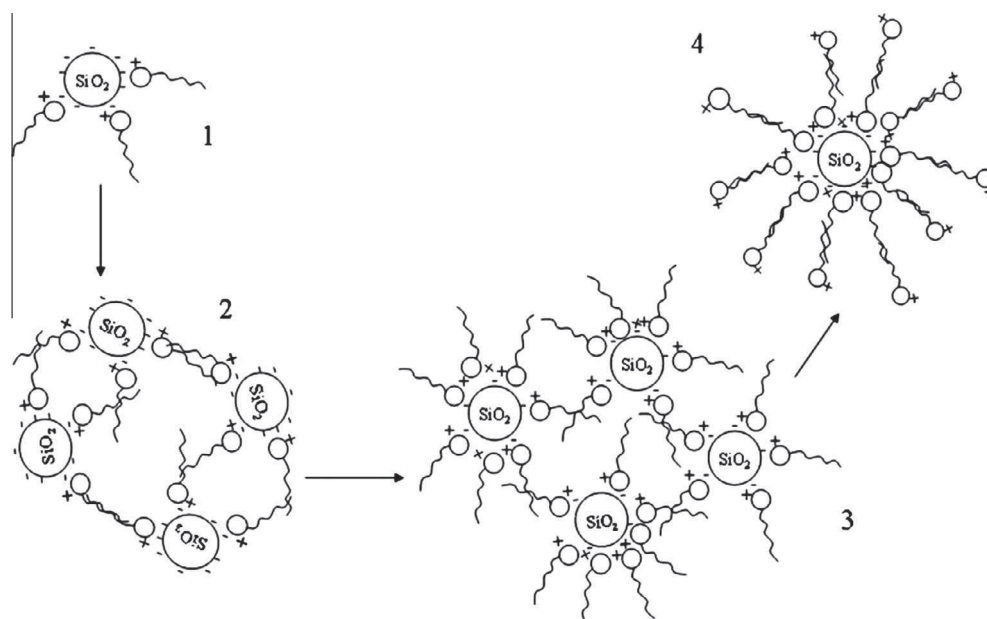

Fig. 7. Possible simplified scheme of CTAB on SiO_2 /water interface; counterions Br^- are omitted, and length scales of nanoparticles and CTAB chains are changed respectively for clarity.

The aggregation of 3OR25 with CTAB may combine the charge neutralization effect and hydrophobic effect (bridging effect), and the latter seems to have a remarkable influence. Therefore, it is likely to separate nanoparticles of about 30 nm with very small quantity of CTAB and minimize the sludge in the further separation process. The results concerning the smaller silica nanoparticles show different agglomeration mechanisms comparing with those for large particles. This is of great importance for water treatment: a special attention has to be paid to the treatment process of wastewaters containing nanoparticles.

Acknowledgements

The authors are grateful to CNRS (Projet PEPS), Région Midi Pyrénées and French National Research Agency (NANOSEP, ANR-08-ECOT-009) for financial support. We acknowledge China scholarship council (CSC) for the scholarship.

References

- Arvanitoyannis, I.S., 2008. Waste Management for the Food Industries, vol. 396. Elsevier, New York, USA.
- Bi, Z., Liao, W., Qi, L., 2003. Wettability alteration by CTAB adsorption at surfaces of SiO_2 film or silica gel powder and mimic oil recovery. *Appl. Surf. Sci.* 221, 25–31.
- Bizi, M., 2012. Stability and flocculation of nanosilica by conventional organic polymer. *Nat. Sci.* 4, 372–385.
- Brar, S.K., Verma, M., Tyaqi, R.D., Surampalli, R.Y., 2010. Engineered nanoparticles in wastewater and wastewater sludge – evidence and impacts. *Waste Manage.* 30, 504–520.
- Bryleva, E.Y., Vodolazkaya, N.A., Mchedlov-Petrosyan, N.O., Samokhina, L.V., Matveevskaya, N.A., Tolmachev, A.V., 2007. Interfacial properties of cetyltrimethylammonium-coated SiO_2 nanoparticles in aqueous media as studied by using different indicator dyes. *J. Colloid Interface Sci.* 316, 712–722.
- Carolina, V.G., Barney, L.B., 2003. Estimate of the ionization degree of ionic micelles based on Krafft temperature measurements. *J. Phys. Chem. B* 107, 5398–5403.
- Chang, M.R., Lee, D.J., Lai, J.Y., 2007. Nanoparticles in wastewater from a science-based industrial park – coagulation using polyaluminium chloride. *J. Environ. Manage.* 85, 1009–1014.
- Chin, C.J.M., Chen, P.W., Wang, L.J., 2006. Removal of nanoparticles from CMP wastewater by magnetic seeding aggregation. *Chemosphere* 63, 1809–1813.
- Daughton, C.G., 2004. Non-regulated water contaminants: emerging research. *Environ. Impact Assess.* 24, 711–732.
- Furusawa, K., Sato, A., Shirai, J., Nashima, T., 2002. Depletion flocculation of latex dispersion in ionic micellar systems. *J. Colloid Interface Sci.* 253, 273–278.
- Gao, H.C., Zhu, R.X., Yang, X.Y., Mao, S.Z., Zhao, S., Yu, J.Y., Du, Y.R., 2004. Properties of polyethylene glycol (23) lauryl ether with cetyltrimethylammonium bromide

- in mixed aqueous solutions studied by self-diffusion coefficient NMR. *J. Colloid Interface Sci.* 273, 626–631.
- Hanna, S.H., 1975. The role of cationic surfactants in the selective flotation of phosphate ore constituents. *Powder Technol.* 12, 57–64.
- Hu, Y., Jiang, H., Wang, D., 2003. Electrokinetic behavior and flotation of kaolinite in CTAB solution. *Miner. Eng.* 16, 1221–1223.
- Hu, C.Y., Lo, S.L., Li, C.M., Kuan, W.H., 2005. Treating chemical mechanical polishing (CMP) wastewater by electro-coagulation–flotation process by surfactant. *J. Hazard Mater. A* 120, 15–20.
- Huang, J.Z., 2009. Efficacité De Capture Dans Les Procédés De Flottation. Institut National des Sciences Appliquées de Toulouse, France.
- Kin, K.T., Tang, H.S., Chan, S.F., Raghavan, S., Martinez, S., 2006. Treatment of chemical–mechanical planarization wastes by electrocoagulation/electro-fenton method. *IEEE Trans. Semicond. Manuf.* 19, 208–215.
- Kobayashi, M., Juillerat, F., Galletto, P., Bowen, P., Borkovec, M., 2005. Aggregation and charging of colloidal silica particles: effect of particle size. *Langmuir* 21, 5761–5769.
- Lai, C.L., Lin, S.H., 2003. Electrocoagulation of chemical mechanical polishing (CMP) wastewater from semiconductor fabrication. *Chem. Eng. J.* 95, 205–211.
- Lien, C.Y., Liu, J.C., 2006. Treatment of polishing wastewater from semiconductor manufacturer by dispersed air flotation. *J. Environ. Eng.* 132, 51–57.
- Liu, Y., Tourbin, M., Lachaize, S., Guiraud, P., 2012. Silica nanoparticle separation from water by aggregation with AlCl_3 . *Ind. Eng. Chem. Res.* 51, 1853–1863.
- Lu, K., 2007. Theoretical analysis of colloidal interaction energy in nanoparticle suspensions. *Ceram. Int.* 34, 1353–1360.
- Maiti, P.K., Kremer, K., Flimm, O., Chowdhury, D., Stauffer, D., 2000. Cross-Linking of Micelles by Gemini Surfactants. <http://arxiv.org/PS_cache/cond-mat/pdf/9912/9912002v2.pdf>.
- Modaressi, A., Sifaoui, H., Grzesiak, B., Solimando, R., Domanskac, U., Rogalski, M., 2007. CTAB aggregation in aqueous solutions of ammonium based ionic liquids; conductimetric studies. *Colloid. Surface. A* 296, 104–108.
- Moore, M.N., 2006. Do nanoparticles present ecotoxicological risks for the health of the aquatic environment? *Environ. Int.* 32, 967–976.
- Ostiguy, C., Trotier, M., Lapointe, G., Boutin, M., Menard, L., Antoun, M., Cloutier, Y., Normand, C., 2006. Nanoparticles: Current Knowledge About the Risks and Preventive Measurement (IRSST – Les Nanoparticules: Connaissances Actuelles Sur Les Risqué Et Les Mesures De Prévention En SST). IRSST, Montréal (Québec).
- Reijnders, L., 2006. Cleaner nanotechnology and hazard reduction. *J. Cleaner Prod.* 14, 124–133.
- Shi, J., 2002. Steric stabilization. *Croup Inorganic Materials Science – Literature review*, The Ohio State University, Columbus, USA.
- Tsai, J.C., Kumar, M., Chen, S.Y., Lin, J.G., 2007. Nano-bubble flotation technology with coagulation process for the cost-effective treatment of chemical mechanical polishing wastewater. *Sep. Purif. Technol.* 58, 61–67.
- Weinberg, H., Galyean, A., Leopold, M., 2011. Evaluating engineered nanoparticles in natural waters. *Trends Anal. Chem.* 30, 72–83.
- Yang, G.C.C., Tsai, C.M.T., 2006. Performance evaluation of a simultaneous electrocoagulation and electrofiltration module for the treatment of Cu-CMP and oxide-CMP wastewaters. *J. Membr. Sci.* 286, 36–44.
- Zhang, Y., Chen, Y., Westerhoff, P., Hristovski, K., Crittenden, J.C., 2008. Stability of commercial metal oxide nanoparticles in water. *Water Res.* 42, 2204–2212.