



HAL
open science

Subcubic triangle-free graphs have fractional chromatic number at most $14/5$

Zdeněk Dvořák, Jean-Sébastien Sereni, Jan Volec

► **To cite this version:**

Zdeněk Dvořák, Jean-Sébastien Sereni, Jan Volec. Subcubic triangle-free graphs have fractional chromatic number at most $14/5$. 2013. hal-00779634v2

HAL Id: hal-00779634

<https://hal.science/hal-00779634v2>

Submitted on 28 May 2013 (v2), last revised 7 Jan 2016 (v3)

HAL is a multi-disciplinary open access archive for the deposit and dissemination of scientific research documents, whether they are published or not. The documents may come from teaching and research institutions in France or abroad, or from public or private research centers.

L'archive ouverte pluridisciplinaire **HAL**, est destinée au dépôt et à la diffusion de documents scientifiques de niveau recherche, publiés ou non, émanant des établissements d'enseignement et de recherche français ou étrangers, des laboratoires publics ou privés.

Subcubic triangle-free graphs have fractional chromatic number at most $14/5^*$

Zdeněk Dvořák[†] Jean-Sébastien Sereni[‡] Jan Volec[§]

Abstract

We prove that every subcubic triangle-free graph has fractional chromatic number at most $14/5$, thus confirming a conjecture of Heckman and Thomas [A new proof of the independence ratio of triangle-free cubic graphs. *Discrete Math.* 233 (2001), 233–237].

1 Introduction

One of the most celebrated results in Graph Theory is the Four-Color Theorem (4CT). It states that every planar graph is 4-colorable. It was solved by Appel and Haken [3, 5, 4] in 1977, and, about twenty years later, Robertson, Sanders, Seymour and Thomas [18] found a new (and much simpler) proof. However, both of the proofs require a computer assistance, and finding a fully human-checkable proof is still one of the main open problems in Graph Theory. An immediate corollary of the 4CT implies that every n -vertex planar graph

*This research was supported by LEA STRUCO and the Czech-French bilateral project MEB 021115 (French reference PHC Barrande 24444XD).

[†]Computer Science Institute of Charles University, Prague, Czech Republic. E-mail: rakdver@iuuk.mff.cuni.cz. Supported by the Center of Excellence – Inst. for Theor. Comp. Sci., Prague, project P202/12/G061 of Czech Science Foundation.

[‡]CNRS (LORIA), Nancy, France. E-mail: sereni@kam.mff.cuni.cz. This author's work was partially supported by the French *Agence Nationale de la Recherche* under reference ANR 10 JCJC 0204 01.

[§]Computer Science Institute of Charles University, Prague, Czech Republic, and LIAFA, Univ. Paris Diderot, Paris, France. E-mail: honza@ucw.cz. This author's work was supported by a grant of the French Government. (Since January 2013, this author is a Ph.D. student at University of Warwick.)

contains an independent set of size $n/4$ (this statement is sometimes called the Erdős-Vizing conjecture). Although this seems to be an easier problem than the 4CT itself, no proof without the 4CT is known. The best known result that does not use the 4CT is due to Albertson [1], who showed the existence of an independent set of size $2n/9$.

An intermediate step between the 4CT and the Erdős-Vizing conjecture is the fractional version of the 4CT — every planar graph is fractionally 4-colorable. In fact, fractional colorings were introduced in 1973 [12] as an approach for either disproving, or giving more evidence to the 4CT. For a real number k , a graph G is fractionally k -colorable, if for every assignment of weights to its vertices there is an independent set that contains at least $(1/k)$ -fraction of the total weight. In particular, every fractionally k -colorable graph on n vertices contains an independent set of size at least n/k . The existence of independent sets of certain ratios in *subcubic* graphs, i.e., graphs with maximum degree at most 3, led Heckman and Thomas to pose the following two conjectures.

Conjecture 1 (Heckman and Thomas [10]). *Every subcubic triangle-free graph is fractionally $14/5$ -colorable.*

Conjecture 2 (Heckman and Thomas [11]). *Every subcubic triangle-free planar graph is fractionally $8/3$ -colorable.*

Note that a graph is called *triangle-free* if it does not contain a triangle as a subgraph. The purpose of this work is to establish Conjecture 1.

1.1 History of the problem and related results

Unlike for general planar graphs, colorings of triangle-free planar graphs are well understood. Already in 1959, Grötzsch [8] proved that every triangle-free planar graph is 3-colorable. Therefore, such a graph on n vertices has to contain an independent set of size $n/3$. In 1976, Albertson, Bollobás and Tucker [2] conjectured that a triangle-free planar graph also has to contain an independent set of size strictly larger than $n/3$.

Their conjecture was confirmed in 1993 by Steinberg and Tovey [21], even in a stronger sense: such a graph admits a 3-coloring where at least $\lfloor n/3 \rfloor + 1$ vertices have the same color. On the other hand, Jones [13] found an infinite family of triangle-free planar graphs with maximum degree four and no independent set of size $\lfloor n/3 \rfloor + 2$. However, if the maximum degree

is at most three, then Albertson et al. [2] conjectured that an independent set of size much larger than $n/3$ exists. Specifically, they asked whether there is a constant $s \in (\frac{1}{3}, \frac{3}{8}]$, such that every subcubic triangle-free planar graph contains an independent set of size sn . We note that for $s > 3/8$ the statement would not be true.

The strongest possible variant of this conjecture, i.e., for $s = 3/8$, was finally confirmed by Heckman and Thomas [11]. However, for $s = 5/14$, it was implied by a much earlier result of Staton [20], who actually showed that every subcubic triangle-free (but not necessarily planar) graph contains an independent set of size $5n/14$. Jones [14] then found a simpler proof of this result; an even simpler one is due to Heckman and Thomas [10]. On the other hand, Fajtlowicz [6] observed that one cannot prove anything larger than $5n/14$. As we already mentioned, the main result of this paper is the strengthening of Staton's theorem to the fractional (weighted) version, which was conjectured by Heckman and Thomas [10].

This conjecture attracted a considerable amount of attention and it spawned a number of interesting works in the last few years. In 2009, Hatami and Zhu [9] showed that for every graph that satisfies the assumptions of Conjecture 1, the fractional chromatic number is at most $3 - 3/64 \approx 2.953$. (The fractional chromatic number of a graph is the smallest number k such that the graph is fractionally k -colorable.) The result of Hatami and Zhu is the first to establish that the fractional chromatic number of every subcubic triangle-free graph is smaller than 3. In 2012, Lu and Peng [17] improved the bound to $3 - 3/43 \approx 2.930$. There are also two very recent improvements on the upper bound — but with totally different approaches. The first one is due to Ferguson, Kaiser and Král' [7], who showed that the fractional chromatic number is at most $32/11 \approx 2.909$. The other one is due to Liu [16], who improved the upper bound to $43/15 \approx 2.867$.

2 Preliminaries

We start with another definition of a fractional coloring that will be used in the paper. It is equivalent to the one mentioned in the previous section by Linear Programming Duality; a formal proof is found at the end of this section in Theorem 3. There are also another different (but equivalent) definitions of a fractional coloring and the fractional chromatic number; for more details see, e.g., the book of Scheinerman and Ullman [19].

Let G be a graph. A *fractional k -coloring* is an assignment of measurable subsets of the interval $[0, 1]$ to the vertices of G such that each vertex is assigned a subset of measure $1/k$ and the subsets assigned to adjacent vertices are disjoint. The *fractional chromatic number of G* is the infimum over all positive real numbers k such that G admits a fractional k -coloring. Note that for finite graphs, such a real k always exists, the infimum is in fact a minimum, and its value is always rational. We let $\chi_f(G)$ be this minimum.

A *demand function* is a function from $V(G)$ to $[0, 1]$ with rational values. A *weight function* is a function from $V(G)$ to the real numbers. A weight function is *non-negative* if all its values are non-negative. For a weight function w and a set $X \subseteq V(G)$, let $w(X) = \sum_{v \in X} w(v)$. For a demand function f , let $w_f = \sum_{v \in V(G)} f(v)w(v)$.

Let μ be the Lebesgue measure on real numbers. An *f -coloring* of G is an assignment φ of measurable subsets of $[0, 1]$ to the vertices of G such that $\mu(\varphi(v)) \geq f(v)$ for every $v \in V(G)$ and such that $\varphi(u) \cap \varphi(v) = \emptyset$ whenever u and v are two adjacent vertices of G . A positive integer N is a *common denominator* for f if $N \cdot f(v)$ is an integer for every $v \in V(G)$. For integers a and b , we define $\llbracket a, b \rrbracket$ to be the set $\{a, a+1, \dots, b\}$, which is empty if $a > b$; we set $\llbracket a \rrbracket = \llbracket 1, a \rrbracket$. Let N be a common denominator for f and ψ a function from $V(G)$ to subsets of $\llbracket N \rrbracket$. We say that ψ is an *(f, N) -coloring* of G if $|\psi(v)| \geq Nf(v)$ for every $v \in V(G)$ and $\psi(u) \cap \psi(v) = \emptyset$ whenever u and v are adjacent vertices of G .

Let us make a few remarks on these definitions.

- If G has an (f, N) -coloring, then it also has an (f, M) -coloring for every M divisible by N , obtained by replacing each color by M/N new colors. Consequently, the following statement, which is occasionally useful in the proof, holds: if a graph G_1 has an (f_1, N_1) -coloring and a graph G_2 has an (f_2, N_2) -coloring, then there exists an integer N such that G_1 has an (f_1, N) -coloring and G_2 has an (f_2, N) -coloring.
- For a rational number r , the graph G has fractional chromatic number at most r if and only if it has an f_r -coloring for the function f_r that assigns $1/r$ to every vertex of G . If rN is an integer, then an (f_r, N) -coloring is usually called an $(rN : N)$ -coloring in the literature.
- In the definition of an (f, N) -coloring, we can require that $|\psi(v)| = Nf(v)$ for each vertex, as if $|\psi(v)| > Nf(v)$, then we can remove colors from $\psi(v)$. In particular, throughout the argument, whenever we receive

an (f, N) -coloring from an application of an inductive hypothesis, we assume that the equality holds for every vertex.

To establish Theorem 5, we use several characterizations of f -colorings. For a graph G , let $\mathcal{I}(G)$ be the set of all maximal independent sets. Let FRACC be the following linear program.

$$\begin{aligned} \text{Minimize: } & \sum_{I \in \mathcal{I}(G)} x(I) \\ \text{subject to: } & \sum_{\substack{I \in \mathcal{I}(G) \\ v \in I}} x(I) \geq f(v) \quad \text{for } v \in V(G); \\ & x(I) \geq 0 \quad \text{for } I \in \mathcal{I}(G). \end{aligned}$$

Furthermore, let FRACD be the following program, which is the dual of FRACC.

$$\begin{aligned} \text{Maximize: } & \sum_{v \in V(G)} f(v) \cdot y(v) \\ \text{subject to: } & \sum_{v \in I} y(v) \leq 1 \quad \text{for } I \in \mathcal{I}(G); \\ & y(v) \geq 0 \quad \text{for } v \in V(G). \end{aligned}$$

Notice that all the coefficients are rational numbers. Therefore, for both programs there exist optimal solutions that are rational. Moreover, since these two linear programs are dual of each other, the LP-duality theorem ensures that they have the same value. (The reader is referred to, e.g., the book by Scheinerman and Ullman [19] for more details on fractional graph theory.)

The following statement holds by standard arguments; the proof is included for completeness.

Theorem 3. *Let G be a graph and f a demand function for G . The following statements are equivalent.*

- (a) *The graph G has an f -coloring.*
- (b) *There exists a common denominator N for f such that G has an (f, N) -coloring.*

(c) For every weight function w , the graph G contains an independent set X such that $w(X) \geq w_f$.

(d) For every non-negative weight function w , the graph G contains an independent set X such that $w(X) \geq w_f$.

Proof. Let us realize that (c) and (d) are indeed equivalent. On the one hand, (c) trivially implies (d). On the other hand, let w be a weight function. For each vertex $v \in V(G)$, set $w'(v) = \max\{0, w(v)\}$. By (d), there exists an independent set I' of G such that $w'(I') \geq \sum_{v \in V(G)} f(v)w'(v)$. Setting $I = \{v \in I' : w(v) > 0\}$ yields a (possibly empty) independent set of G with $w(I) \geq w_f$. Hence, (d) implies (c).

We now prove that (b) \Rightarrow (a) \Rightarrow (d) \Rightarrow (b).

(b) \Rightarrow (a): Assume that ψ is an (f, N) -coloring of G , where N is a common denominator for f . Setting

$$\varphi(v) = \bigcup_{i \in \psi(v)} \left[\frac{i-1}{N}, \frac{i}{N} \right)$$

for each vertex $v \in V(G)$ yields an f -coloring of G .

(a) \Rightarrow (d): Let w be a non-negative weight function and assume that G has an f -coloring ψ . For each set $A \subseteq V(G)$, let

$$X(A) = \bigcap_{v \in A} \psi(v) \setminus \bigcup_{v \in V(G) \setminus A} \psi(v),$$

where $\bigcap_{v \in \emptyset} \psi(v)$ is defined to be $[0, 1]$. Note that the sets $X(A) : A \subseteq V(G)$ are pairwise disjoint and their union is $[0, 1]$. Let us choose a set $I \subseteq V(G)$ at random so that $\text{Prob}[I = A] = \mu(X(A))$ for each $A \subseteq V(G)$. Since ψ is an f -coloring of G , we have $X(A) = \emptyset$ if A is not an independent set, and thus I is an independent set with probability 1. Furthermore, $\text{Prob}[v \in I] = \sum_{\{v\} \subseteq A \subseteq V(G)} \mu(X(A)) = \mu(\psi(v)) \geq f(v)$ for each $v \in V(G)$. We conclude that

$$\begin{aligned} \mathbb{E}[w(I)] &= \sum_{v \in V(G)} \text{Prob}[v \in I] w(v) \\ &\geq \sum_{v \in V(G)} f(v) w(v) = w_f. \end{aligned}$$

Therefore, there exists $I \in \mathcal{I}(G)$ with $w(I) \geq w_f$.

(d) \Rightarrow (b): We proceed in two steps. First, we show that, assuming (d), the value of FRACC is at most 1. Next, we infer the existence of an (f, N) -coloring of G for a common denominator N of f .

Let b be the value of FRACD and let y be a corresponding solution. Note that y is a non-negative weight function for G , and thus by (d), there exists an independent set I of G such that $y(I) \geq y_f = b$. Since y is a feasible solution of FRACD, we deduce that $b \leq 1$.

By the LP-duality theorem, FRACD and FRACC have the same value. Let x be a rational feasible solution of FRACC with value at most 1. Fix a common denominator N for f and x . An (f, N) -coloring ψ of G can be built as follows. Set $\mathcal{I}' = \{I \in \mathcal{I}(G) : x(I) > 0\}$ and let I_1, \dots, I_k be the elements of \mathcal{I}' . For each $i \in \{1, \dots, k\}$, set

$$T_i = \left[\left[1 + N \cdot \sum_{j=1}^{i-1} x(I_j), N \cdot \sum_{j=1}^i x(I_j) \right] \right].$$

Observe that $\left| \bigcup_{i=1}^k T_i \right| = \sum_{i=1}^k |T_i| = N \cdot \sum_{i=1}^k x(I_i) \leq N$. For each vertex $v \in V(G)$, let $\mathcal{I}(v) = \{i \in [k] : v \in I_i\}$ and define $\psi(v) = \bigcup_{i \in \mathcal{I}(v)} T_i$.

The obtained function ψ is an (f, N) -coloring of G . Indeed, for each vertex $v \in V(G)$ we have $|\psi(v)| \geq N \cdot \sum_{i \in \mathcal{I}(v)} x(I_i) \geq Nf(v)$. Moreover, if u and v are two vertices adjacent in G , then $\mathcal{I}(u) \cap \mathcal{I}(v) = \emptyset$ and, consequently, $\psi(u) \cap \psi(v) = \emptyset$.

□

3 The proof

We commonly use the following observation.

Proposition 4. *Let f be a demand function for a graph G , let N be a common denominator for f and let ψ be an (f, N) -coloring for G .*

1. *If xyz is a path in G , then $|\psi(x) \cup \psi(z)| \leq (1 - f(y))N$. Equivalently, $|\psi(x) \cap \psi(z)| \geq (f(x) + f(z) + f(y) - 1)N$.*
2. *If $xvyz$ is a path in G , then $|\psi(x) \cap \psi(z)| \leq (1 - f(v) - f(y))N$.*

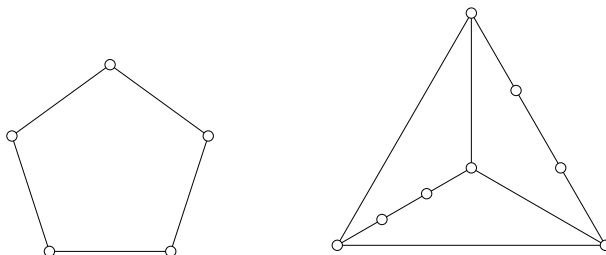

Figure 1: Dangerous graphs.

Conversely, if $f(a) + f(b) \leq 1$ for each edge ab of the path and ψ is an (f, N) -coloring of x and z satisfying the conditions 1. and 2. above, then ψ can be extended to an (f, N) -coloring of the path xyz or $xvyz$, respectively.

A graph H is *dangerous* if H is either a 5-cycle or the graph K'_4 obtained from K_4 by subdividing both edges of its perfect matching twice, see Figure 1. The vertices of degree two of a dangerous graph are called *special*. Let G be a subcubic graph and let B be a subset of its vertices. Let H be a dangerous induced subgraph of G . A special vertex v of H is *B-safe* if either $v \in B$ or v has degree three in G . If B is empty, we write just “safe” instead of “ \emptyset -safe”. If G is a subcubic graph, a set $B \subseteq V(G)$ is called a *nail* if every vertex in B has degree at most two and every dangerous induced subgraph of G contains at least two B -safe special vertices. For a subcubic graph G and its nail B , let f_B^G be the demand function defined as follows: if $v \in B$, then $f_B^G(v) = (7 - \deg_G(v))/14$; otherwise $f_B^G(v) = (8 - \deg_G(v))/14$. When the graph G is clear from the context, we drop the superscript and write just f_B for this demand function.

In order to show that every subcubic triangle-free graph has fractional chromatic number at most $14/5$, we prove the following stronger statement.

Theorem 5. *If G is a subcubic triangle-free graph and $B \subseteq V(G)$ is a nail, then G has an f_B -coloring.*

We point out that the motivation for the formulation of Theorem 5 as well as for some parts of its proof comes from the work of Heckman and Thomas [10], in which an analogous strengthening is used to prove that every subcubic triangle-free graph on n vertices contains an independent set of size at least $5n/14$.

A subcubic triangle-free graph G with a nail B is a *minimal counterexample to Theorem 5* if G has no f_B -coloring, and for every subcubic triangle-free graph G' with a nail B' such that either $|V(G')| < |V(G)|$, or $|V(G')| = |V(G)|$ and $|B'| < |B|$, there exists an $f_{B'}$ -coloring of G' . The proof proceeds by contradiction, showing that there is no minimal counterexample to Theorem 5. Let us first study the properties of such a hypothetical minimal counterexample.

Lemma 6. *If a subcubic triangle-free graph G with a nail B is a minimal counterexample to Theorem 5, then G is 2-edge-connected.*

Proof. Clearly, G is connected. Suppose that $uv \in E(G)$ is a bridge, and let G_1 and G_2 be the components of $G - uv$ such that $u \in V(G_1)$ and $v \in V(G_2)$. Let $B_1 = (B \cap V(G_1)) \cup \{u\}$ and $B_2 = (B \cap V(G_2)) \cup \{v\}$. Note that B_1 is a nail for G_1 and B_2 is a nail for G_2 , and thus by the minimality of G , there exist a common denominator N for f_1 and f_2 , an (f_{B_1}, N) -coloring ψ_1 for G_1 and an (f_{B_2}, N) -coloring ψ_2 for G_2 . Since $u \in B_1$ and $v \in B_2$, we have $f_{B_1}^{G_1}(u) \leq 7/14$ and $f_{B_2}^{G_2}(v) \leq 7/14$, thus we can assume (by permuting the colors in ψ_2 if necessary) that $\psi_1(u)$ and $\psi_2(v)$ are disjoint. It follows that the union of ψ_1 and ψ_2 is an (f_B, N) -coloring of G , contrary to the assumption that G is a counterexample. \square

Lemma 7. *If a subcubic triangle-free graph G with a nail B is a minimal counterexample to Theorem 5, then G has minimum degree at least two.*

Proof. Suppose, on the contrary, that v is a vertex of degree at most one in G . Since G is 2-edge-connected by Lemma 6, it follows that v has degree 0 and $V(G) = \{v\}$. However, $\varphi(v) = [0, 1]$ is then an f_B -coloring of G , since $\mu(\varphi(v)) = 1 > f_B(v)$. This contradicts the assumption that G is a counterexample. \square

Lemma 8. *If a subcubic triangle-free graph G with a nail B is a minimal counterexample to Theorem 5, then $B = \emptyset$.*

Proof. Suppose, on the contrary, that B contains a vertex b . If $B' = B \setminus \{b\}$ were a nail in G , then by the minimality of G and B , there would exist an $f_{B'}$ -coloring of G , which would also be an f_B -coloring of G . Therefore, we can assume that G contains a dangerous induced subgraph H with at most one B' -safe vertex. Since G is 2-edge-connected by Lemma 6, it follows

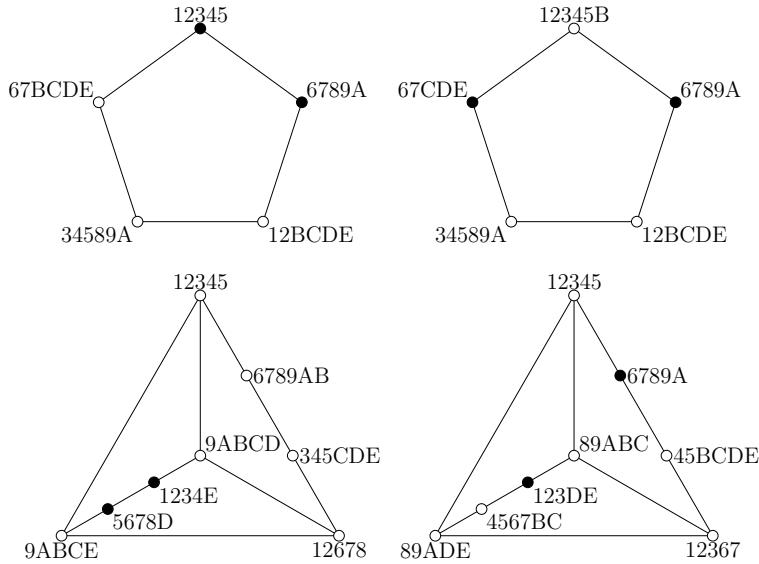

Figure 2: Colorings of dangerous graphs with minimal nails. The nails consist of the black vertices.

that $G = H$. Consequently, B consists of exactly two special vertices of G . However, Figure 2 shows all possibilities for G and B up to isomorphism together with their $(f_B, 14)$ -colorings, contradicting the assumption that G is a counterexample. \square

In view of the previous lemma, we say that a subcubic triangle-free graph G is a minimal counterexample to Theorem 5 if the empty set is a nail for G and together they form a minimal counterexample to Theorem 5.

Lemma 9. *Let G be a minimal counterexample to Theorem 5. If u and v are adjacent vertices of G of degree two, then there exists a 5-cycle in G containing the edge uv .*

Proof. Suppose, on the contrary, that uv is not contained in a 5-cycle. Let x and y be the neighbors of u and v , respectively, that are not in $\{u, v\}$. Note that $x \neq y$ since G is triangle-free. Let G' be the graph obtained from $G - \{u, v\}$ by adding the edge xy . Since the edge uv is not contained in a 5-cycle, it follows that G' is triangle-free.

If the empty set is a nail for G' , then by the minimality of G , there exists an $(f_{\emptyset}, 14t)$ -coloring ψ' of G' for a positive integer t . The sets $\psi'(x)$ and

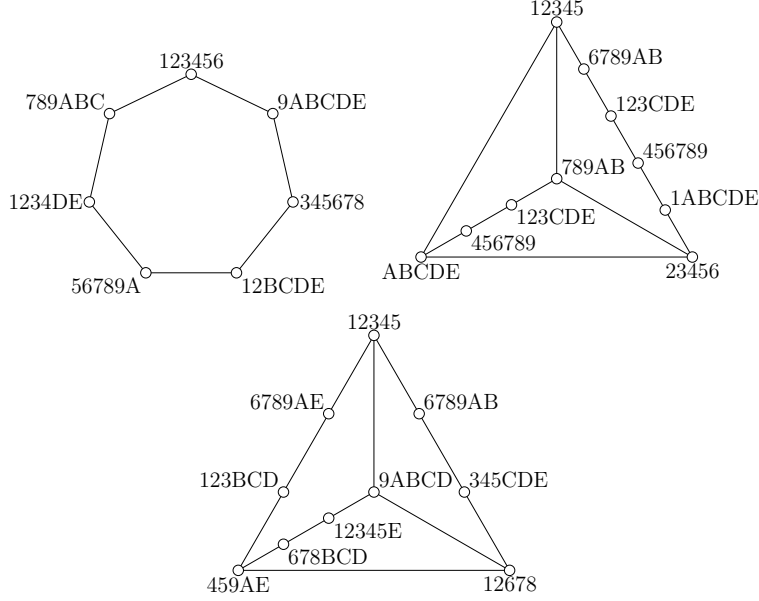

Figure 3: Colorings of subdivided dangerous graphs.

$\psi'(y)$ are disjoint; by permuting the colors if necessary, we can assume that $\psi'(x) \subseteq \llbracket 6t \rrbracket$ and $\psi'(y) \subseteq \llbracket 6t+1, 12t \rrbracket$. Then, there exists an $(f_\emptyset, 14t)$ -coloring ψ of G , defined by $\psi(z) = \psi'(z)$ for $z \notin \{u, v\}$, $\psi(u) = \llbracket 6t+1, 12t \rrbracket$ and $\psi(v) = \llbracket 6t \rrbracket$. This contradicts the assumption that G is a counter-example.

We conclude that \emptyset is not a nail for G' . Thus if x and y are adjacent in G , then both these vertices have degree 3 in G since G is a minimal counter-example. Therefore, the very same argument as above using $\{x, y\}$ as a nail for G' yields an f_\emptyset -coloring for G , a contradiction.

As observed earlier, G' contains a dangerous induced subgraph H with at most one safe special vertex. Lemma 6 implies that G is 2-edge-connected, and thus G' is 2-edge-connected as well. It follows that $G' = H$. Consequently, since x and y are not adjacent, G is one of the graphs depicted in Figure 3, which are exhibited together with an $(f_\emptyset, 14)$ -coloring. This is a contradiction. \square

Lemma 10. *Let G be a minimal counterexample to Theorem 5. If $\{uv, xy\}$ is an edge-cut in G and G_1 and G_2 are connected components of $G - \{uv, xy\}$, then $\min\{|V(G_1)|, |V(G_2)|\} \leq 2$.*

Proof. Suppose, on the contrary, that $\min\{|V(G_1)|, |V(G_2)|\} \geq 3$. Choose the labels so that $\{u, x\} \subset V(G_1)$.

Suppose first that say G_1 is a path uzx on three vertices. By Lemma 9, the vertices y and v are adjacent. Since $|V(G_2)| \geq 3$ and G is 2-edge-connected by Lemma 6, it follows that y and v have degree three in G . Note that $B' = \{y, v\}$ is a nail for G_2 . By the minimality of G , there exists an $(f_{B'}, 14t)$ -coloring ψ of G_2 for a positive integer t . Since y and v are adjacent, by permuting the colors, we can assume that $\psi(y) = \llbracket 5t \rrbracket$ and $\psi(v) = \llbracket 5t + 1, 10t \rrbracket$. Let us extend ψ by defining $\psi(u) = \llbracket 2t \rrbracket \cup \llbracket 10t + 1, 14t \rrbracket$, $\psi(z) = \llbracket 2t + 1, 8t \rrbracket$ and $\psi(x) = \llbracket 8t + 1, 14t \rrbracket$. Then ψ is an $(f_\emptyset, 14t)$ -coloring of G , contrary to the assumption that G is a counterexample.

By symmetry, we conclude that neither G_1 nor G_2 is a path on three vertices; and more generally, neither G_1 nor G_2 is a path, as otherwise G would contain a 2-edge-cut cutting off a path on three vertices. Therefore, we can choose the edge-cut $\{uv, xy\}$ in such a way that both x and v have degree three. Let G'_1 be the graph obtained from G_1 by adding a path $uabx$, and let G'_2 be the graph obtained from G_2 by adding a path $vcdy$, where a, b, c and d are new vertices of degree two. Since G is 2-edge-connected, we have $u \neq x$ and $v \neq y$; hence, both G'_1 and G'_2 are triangle-free. If y has degree three, then let $B_1 = \{a, b\}$, otherwise let $B_1 = \emptyset$. Similarly, if u has degree three, then let $B_2 = \{c, d\}$, otherwise let $B_2 = \emptyset$.

Suppose first that B_1 is a nail for G'_1 and B_2 is a nail for G'_2 . By the minimality of G , there exist an $(f_{B_1}, 14t)$ -coloring ψ_1 of G'_1 and an $(f_{B_2}, 14t)$ -coloring ψ_2 of G'_2 , for a positive integer t . Let $n_u = |\psi_1(u) \setminus \psi_1(x)|$, $n_x = |\psi_1(x) \setminus \psi_1(u)|$, $n_{ux} = |\psi_1(u) \cap \psi_1(x)|$, and let n_v, n_y and n_{vy} be defined symmetrically. Proposition 4 implies that $n_{ux} \leq 4t$ and $n_{vx} \leq 4t$. Since x and v have degree three and u and y have degree at least two, it follows that $n_x + n_{ux} = 5t$, $n_u + n_{ux} \leq 6t$, $n_v + n_{vy} = 5t$ and $n_y + n_{vy} \leq 6t$. Furthermore, by the choice of B_1 and B_2 , either $n_u + n_{ux} = 5t$ or $n_{vy} \leq 2t$, and either $n_y + n_{vy} = 5t$ or $n_{ux} \leq 2t$. Therefore,

$$n_{ux} + n_{vy} + \max(n_u, n_y) + \max(n_v, n_x) \leq 14t. \quad (1)$$

Consequently, we can permute the colors in ψ_1 and ψ_2 so that the sets $\psi_1(u) \cap \psi_1(x)$, $\psi_2(v) \cap \psi_2(y)$, $(\psi_1(u) \setminus \psi_1(x)) \cup (\psi_2(y) \setminus \psi_2(v))$ and $(\psi_1(x) \setminus \psi_1(u)) \cup (\psi_2(v) \setminus \psi_2(y))$ are pairwise disjoint. Then, $\psi_1(u) \cap \psi_2(v) = \emptyset = \psi_1(x) \cap \psi_2(y)$, thus giving an $(f_\emptyset, 14t)$ -coloring of G , which is a contradiction.

Hence, we can assume that say B_1 is not a nail for G'_1 . Since G is 2-edge-connected, G'_1 is 2-edge-connected as well, and thus it is a dangerous graph.

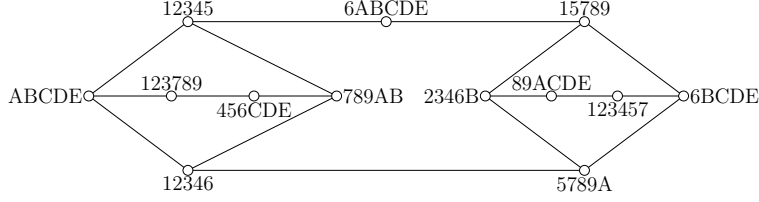

Figure 4: A special 2-cut.

Since G_1 is not a path on three vertices, it follows that G'_1 is K'_4 . Furthermore, $B_1 = \emptyset$ and thus y has degree two. Note that G_1 has an $(f_{\{u,x\}}, 14t)$ -coloring such that $n_{ux} = 4t$ and $n_u = n_x = t$ (obtained from the coloring of the bottom left graph in Figure 2 by removing the black vertices and replacing each color c by t new colors c_1, \dots, c_t). Let G''_2 be the graph obtained from G'_2 by adding a new vertex of degree two adjacent to y and v . Let us point out that y is not adjacent to v , since G is 2-edge-connected (recall that y has degree two since $B_1 = \emptyset$). Hence, G''_2 is triangle-free. If \emptyset is a nail for G''_2 , then let us redefine ψ_2 as an $(f_\emptyset, 14t)$ -coloring of G''_2 , which exists by the minimality of G , and let n_v, n_y and n_{vy} be defined as before. Proposition 4 yields that $n_v + n_y + n_{vy} \leq 8t$; hence, (1) holds, and we obtain a contradiction as in the previous paragraph.

Consequently, \emptyset is not a nail for G''_2 , and since G''_2 is 2-edge-connected and G_2 is not a path, it follows that G''_2 is K'_4 . However, G must then be the graph depicted in Figure 4 together with its $(f_\emptyset, 14)$ -coloring, contrary to the assumption that G is a counterexample. \square

Corollary 11. *Every dangerous induced subgraph in a minimal counterexample to Theorem 5 contains at least three safe special vertices.*

Proof. Let H be a dangerous induced subgraph in a minimal counterexample G . Since \emptyset is a nail for G , it follows that H contains at least two safe special vertices u and v . If H contains exactly two safe special vertices, then the edges of $E(G) \setminus E(H)$ incident with u and v form a 2-edge-cut. By Lemma 10, we know that G consists of H and a path Q of length two or three joining u and v . Note that u and v are not adjacent, as otherwise Q would either be part of a triangle or contradict Lemma 9. If H is a 5-cycle, then G has an $(f_\emptyset, 14)$ -coloring obtained from the coloring of the top right graph in Figure 2 by copying the colors of the vertices of one of the paths between the black vertices to the vertices of Q . Hence, we assume that H is K'_4 . By

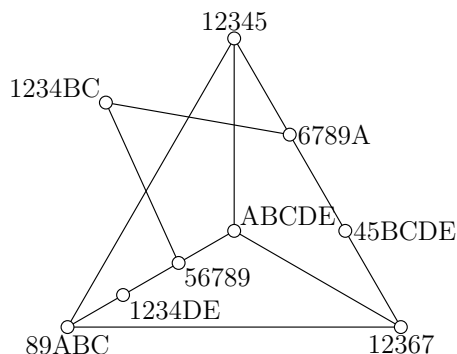

Figure 5: A dangerous induced subgraph with two safe vertices.

Lemma 9, we conclude that Q has length two. Consequently, G is the graph depicted in Figure 5. However, this graph has an $(f_\emptyset, 14)$ -coloring, which is a contradiction. \square

Lemma 12. *If G is a minimal counterexample to Theorem 5, then no two vertices of G of degree two are adjacent.*

Proof. Suppose, on the contrary, that u and v are adjacent vertices of degree two in G . It follows from Lemma 9 that G contains a 5-cycle $xvvyz$. Further, x , y and z have degree three by Corollary 11. Let a , b and c be the neighbors of x , y and z , respectively, outside of the 5-cycle (where possibly $a = b$).

Let us now consider the case where a has degree two. Note that, in this case, $a \neq b$ as G is 2-edge-connected. Let d be the neighbor of a distinct from x . If d has degree two, then by Lemma 9, the path xad is a part of a 5-cycle. Since G is 2-edge-connected, it follows that d is adjacent to c . Then G contains a 2-edge-cut formed by the edges incident with y and c . By Lemma 10, G is one of the graphs in the top of Figure 6. This is a contradiction, as the figure also shows that these graphs are $(f_\emptyset, 14)$ -colorable. Hence, d has degree three. Let $G' = G - \{u, v\}$ and $B' = \{x, y\}$. Then B' is a nail for G' . By the minimality of G , there exists an $(f_{B'}, 14t)$ -coloring ψ' of G' for a positive integer t . Let $L = \llbracket 14t \rrbracket \setminus \psi'(z)$. Note that $|L| = 9t$ and $\psi'(y) \subseteq L$. Since the path $daxz$ is colored and $f_{B'}(a) = 6/14$ and $f_{B'}(x) = 5/14$, Proposition 4 implies that $|\psi'(d) \cap \psi'(z)| \leq 3t$, and thus $|\psi'(d) \cap L| \geq 2t$. We construct an $(f_\emptyset, 14t)$ -coloring ψ of G as follows. We let ψ be equal to ψ' on all vertices but a , x , u and v . Let M be a subset of $\psi(d) \cap L$ of size exactly

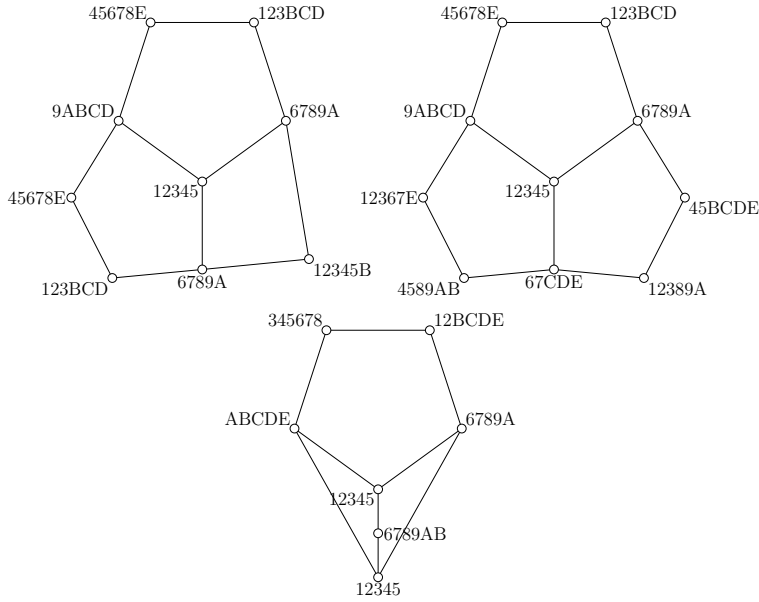

Figure 6: Vertices of degree 2 in a 5-cycle.

2t. Let M' be a subset of $\psi'(y)$ of size exactly $2t$ containing $M \cap \psi'(y)$. We choose $\psi(x)$ of size $5t$ so that $M \cup M' \subset \psi(x) \subseteq M \cup M' \cup (L \setminus \psi'(y))$. Observe that $|\psi(x) \cap \psi(d)| \geq |M| = 2t$ and $|\psi(x) \cap \psi(y)| = |M'| = 2t$; hence, Proposition 4 implies that we can choose $\psi(a)$, $\psi(u)$ and $\psi(v)$ so that ψ is an $(f_\emptyset, 14t)$ -coloring of G . This is a contradiction.

By symmetry, it follows that both a and b have degree three. If $a = b$, then the edges incident with a and z form a 2-edge-cut in G , so Lemma 10 yields that G consists of the 5-cycle $xvvyz$, the vertex a adjacent to x and y , and a path Q of length two or three joining a with z . If Q had length three, then G would be K'_4 , contrary to the assumption that \emptyset is a nail for G . So Q has length two and hence G is the bottom graph in Figure 6, which has an $(f_\emptyset, 14)$ -coloring. This is a contradiction; hence, $a \neq b$.

Suppose now that c has degree two, and let s be the neighbor of c distinct from z . If s has degree two, then using Lemma 9 and symmetry, we can assume that s is adjacent to a . Then the edges incident with a and y form a 2-edge-cut. However, this contradicts Lemma 10 since b has degree three. Hence, s has degree three. Let G' be the graph obtained from $G - \{u, v, x, y, z, c\}$ by adding a path $aopb$ with two new vertices of degree two. Note that

$B' = \{o, p, s\}$ is a nail for G' . By the minimality of G , there exists an $(f_{B'}, 14t)$ -coloring ψ of G' for a positive integer t . Let $L_x = \llbracket 14t \rrbracket \setminus \psi(a)$ and $L_y = \llbracket 14t \rrbracket \setminus \psi(b)$. Thus, $|L_x| = |L_y| = 9t$, and Proposition 4 applied to the path $aopb$ implies that $|L_x \cup L_y| \geq 10t$. Since $|L_x \cup L_y| \leq 14t$, we also know that $|L_x \cap L_y| \geq 4t$. Choose M as an arbitrary subset of $\psi(s)$ of size exactly $2t$. Observe that we can choose $\psi(x)$ in $L_x \setminus M$ and $\psi(y)$ in $L_y \setminus M$, each of size $5t$, so that $|\psi(x) \cap \psi(y)| = 2t$: first choose a set M' of $2t$ colors in $(L_x \cap L_y) \setminus M$; next, choose disjoint sets of size $3t$ from $L_x \setminus (M \cup M')$ and $L_y \setminus (M \cup M')$, which is possible as each of these sets has size at least $3t$ (in fact, at least $5t$) and their union has size at least $6t$. Notice that $|(\psi(x) \cup \psi(y)) \cap \psi(s)| \leq |\psi(s) \setminus M| \leq 3t$. By Proposition 4, ψ extends to an $(f_\emptyset, 14t)$ -coloring of G (to color z and c , apply the Proposition to a path of length three with ends colored by $\psi(s)$ and $\psi(x) \cup \psi(y)$), which is a contradiction.

Therefore, c has degree three. Let $G' = G - \{u, v, y\}$. Suppose first that \emptyset is a nail for G' . By the minimality of G , there exists an $(f_\emptyset^{G'}, 14t)$ -coloring ψ' of G' for a positive integer t . Let $L_x = \llbracket 14t \rrbracket \setminus \psi'(a)$, $L_y = \llbracket 14t \rrbracket \setminus \psi'(b)$ and $L_z = \llbracket 14t \rrbracket \setminus \psi'(c)$. Note that $|L_x| = |L_z| = 9t$ and $|L_y| = 8t$. Also, Proposition 4 implies that $|L_x \cup L_z| \geq 12t$. Arbitrarily choose a set M in $L_z \setminus L_x$ of size exactly $3t$. Note that $|L_z \setminus M| = 6t$ and $|L_y \setminus M| \geq 5t$; hence, there exists a set Z in $L_z \setminus M$ of size exactly $2t$ such that $|L_y \setminus (M \cup Z)| \geq 4t$. Let Y be a subset of $L_y \setminus (M \cup Z)$ of size exactly $4t$. If $|Z \cap L_x| \leq t$, then let $Y' = \emptyset$; otherwise notice that $|L_x \cup Z \cup M| < 13t$ and choose Y' in $\llbracket 14t \rrbracket \setminus (L_x \cup Z \cup M)$ of size exactly t . Finally, choose a set T of size $3t$ so that $Y' \subset T \subset Y \cup Y'$.

Let ψ be an $(f_\emptyset, 14t)$ -coloring of G defined as follows. We set $\psi(p) = \psi'(p)$ for $p \in V(G) \setminus \{x, y, z, u, v, b\}$, $\psi(z) = M \cup Z$, $\psi(u) = M \cup T$ and we let $\psi(y)$ be any set of $5t$ colors such that $Y \cup Y' \subset \psi(y) \subset \llbracket 14t \rrbracket \setminus (M \cup Z)$. Thus, $|\psi(u) \cap \psi(y)| \geq |T| = 3t$, hence we can choose $\psi(v)$ in $\llbracket 14t \rrbracket \setminus (\psi(u) \cup \psi(y))$ of size $6t$. The choice of Y' and T implies that either $|Z \setminus L_x| \geq t$ or $|T \setminus L_x| \geq t$; hence $|L_x \setminus (\psi(u) \cup \psi(z))| = |L_x \setminus (T \cup Z)| \geq |L_x| - |T| - |Z| + t = 5t$. Choose a set $\psi(x)$ in $L_x \setminus (\psi(u) \cup \psi(z))$ of size exactly $5t$. Finally, note that $|\psi(y) \setminus L_y| \leq |\psi(y) \setminus Y| = t$, and select $\psi(b) \subseteq \psi'(b) \setminus (\psi(y) \setminus L_y)$ of size $5t$ (let us point out that $f_\emptyset^{G'}(b) = 6/14$ while $f_\emptyset^G(b) = 5/14$). The existence of the coloring ψ contradicts the assumption that G is a counterexample.

Finally, let us consider the case that \emptyset is not a nail for G' . Therefore, G' contains a dangerous induced subgraph H with at most one safe special vertex. By Corollary 11, H has at least three special vertices that are safe

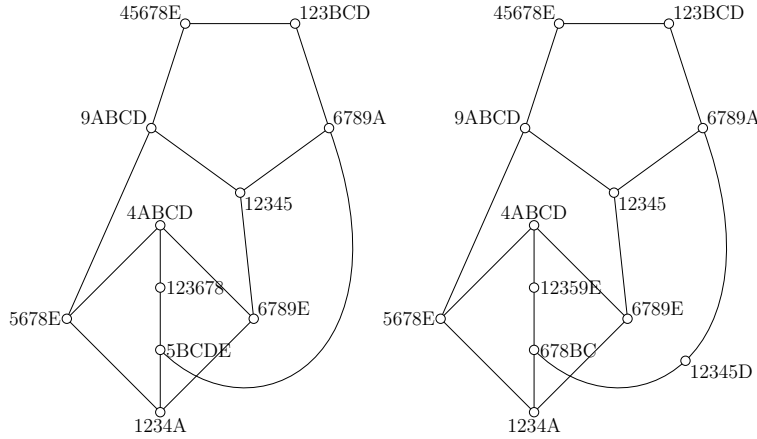

Figure 7: Configurations from Lemma 12.

in G . It follows that H contains at least two of x , z and b . In particular, H contains x or z , and since x and z have degree two in G' , we infer that H contains both of them. Since a and c have degree three in G , we deduce that H is K'_4 . Let s_1 and s_2 be the special vertices of H distinct from x and z . If both s_1 and s_2 have degree three in G , then since \emptyset is not a nail for G' , one of them (say s_1) is adjacent to y (that is, $s_1 = b$); it follows that s_2 is incident with a bridge in G , contrary to Lemma 6. Hence, we can assume that s_2 has degree two in G . By Corollary 11, s_1 has degree three in G . Lemma 10 implies that s_1 and y are joined by a path Q of length at most three. By Lemma 9, the length of the path Q is at most two. Therefore, G is one of the graphs depicted in Figure 7. However, the figure also demonstrates that these graphs are $(f_\emptyset, 14)$ -colorable, which is a contradiction. \square

Lemma 13. *No minimal counterexample to Theorem 5 contains K'_4 as an induced subgraph.*

Proof. Suppose, on the contrary, that a minimal counterexample G contains K'_4 as an induced subgraph. That is, G contains a 4-cycle $uvxy$ of vertices of degree three together with paths $uabx$ and $vcdy$. By Corollary 11, we can assume that b , c and d have degree three in G .

Suppose first that we can choose the subgraph so that a has degree two. Let b' be the neighbor of b distinct from a and x . Since we consider K'_4 as an induced subgraph of G , we have $c \neq b' \neq d$. Let $G' = G - \{u, v, x, y, a, b\}$ and $B' = \{c, d, b'\}$. Since B' is a nail for G' , the minimality of G implies that there

exists an $(f_{B'}, 14t)$ -coloring ψ of G' for a positive integer t . By permuting the colors, we can assume that $\psi(c) = \llbracket 5t \rrbracket$ and $\psi(d) = \llbracket 5t + 1, 10t \rrbracket$.

Note that $|\psi(b')| \leq 6t$. To extend ψ to an $(f_{\emptyset}, 14t)$ -coloring of G , it suffices to show that one can choose sets $\psi(b), \psi(v), \psi(y) \subset \llbracket 14t \rrbracket$ of size $5t$ disjoint from $\psi(b'), \psi(c)$ and $\psi(d)$, respectively, in such a way that $|\psi(v) \cap \psi(y)| = 4t$, $|(\psi(v) \cup \psi(y)) \cup \psi(b)| \leq 9t$ and $|(\psi(v) \cup \psi(y)) \cap \psi(b)| = 2t$. Indeed, if this is possible, then ψ can be further extended to a, u and x by Proposition 4, which contradicts the assumption that G is a counterexample. It remains to show why the aforementioned sets exist. We consider two cases. First, if $|\psi(b') \cap \llbracket 10t + 1, 14t \rrbracket| \leq 2t$, then choose $\psi(b)$ in $\llbracket 14t \rrbracket \setminus \psi(b')$ of size $5t$ so that $|\psi(b) \cap \llbracket 10t + 1, 14t \rrbracket| = 2t$; furthermore, choose $\psi(v)$ and $\psi(y)$ of size $5t$ so that they are disjoint with $\psi(c)$ and $\psi(d)$, respectively, and satisfy $\psi(v) \cap \psi(y) = \llbracket 10t + 1, 14t \rrbracket$ and $(\psi(v) \cup \psi(y)) \cap \psi(b) \subset \llbracket 10t + 1, 14t \rrbracket$. Second, if $|\psi(b') \cap \llbracket 10t + 1, 14t \rrbracket| > 2t$, then note that $|\psi(b') \cap \llbracket 10t \rrbracket| < 4t$; hence, we can choose $\psi(b)$ in $\llbracket 10t \rrbracket \setminus \psi(b')$ of size $5t$ so that $|\psi(b) \cap \llbracket 5t \rrbracket| \geq t$ and $|\psi(b) \cap \llbracket 5t + 1, 10t \rrbracket| \geq t$; next, we choose $\psi(v)$ and $\psi(y)$ of size $5t$ so that they are disjoint from $\psi(c)$ and $\psi(d)$, respectively, and satisfy $\psi(v) \cap \psi(y) = \llbracket 10t + 1, 14t \rrbracket$ and $(\psi(v) \cup \psi(y)) \cap \llbracket 10t \rrbracket \subset \psi(b)$.

The contradiction that we obtained in the previous paragraph shows that a cannot have degree two. Consequently, we can assume that for every occurrence of K'_4 as an induced subgraph in G , all the special vertices are safe. Let $G' = G - \{u, v, x, y\}$ and suppose first that \emptyset is a nail for G' . Then, the minimality of G ensures that there exists an $(f_{\emptyset}^{G'}, 14t)$ -coloring ψ' of G' for a positive integer t . Let $L_u = \llbracket 14t \rrbracket \setminus \psi(a)$, $L_x = \llbracket 14t \rrbracket \setminus \psi(b)$, $L_v = \llbracket 14t \rrbracket \setminus \psi(c)$ and $L_y = \llbracket 14t \rrbracket \setminus \psi(d)$, and note that $|L_u| = |L_v| = |L_x| = |L_y| = 8t$. By Tuza and Voigt [22], there exist sets $A_u \subset L_u$, $A_v \subset L_v$, $A_x \subset L_x$ and $A_y \subset L_y$ such that $|A_u| = |A_v| = |A_x| = |A_y| = 4t$ and $A_x \cup A_u$ is disjoint from $A_y \cup A_v$. Let $M_u = \llbracket 14t \rrbracket \setminus (A_u \cup A_v \cup A_y)$, $M_v = \llbracket 14t \rrbracket \setminus (A_v \cup A_u \cup A_x)$, $M_x = \llbracket 14t \rrbracket \setminus (A_x \cup A_v \cup A_y)$ and $M_y = \llbracket 14t \rrbracket \setminus (A_y \cup A_u \cup A_x)$. Each of these sets having size at least $2t$, applying again the result of Tuza and Voigt [22], we infer the existence of sets $B_u \subset M_u$, $B_v \subset M_v$, $B_x \subset M_x$ and $B_y \subset M_y$ such that $|B_u| = |B_v| = |B_x| = |B_y| = t$ and $B_x \cup B_u$ is disjoint from $B_y \cup B_v$. Let ψ be defined as follows: $\psi(z) = \psi'(z)$ for $z \in V(G) \setminus \{a, b, c, d, u, v, x, y\}$, $\psi(a) = \psi'(a) \setminus B_u$, $\psi(b) = \psi'(b) \setminus B_x$, $\psi(c) = \psi'(c) \setminus B_v$, $\psi(d) = \psi'(d) \setminus B_y$, $\psi(u) = A_u \cup B_u$, $\psi(v) = A_v \cup B_v$, $\psi(x) = A_x \cup B_x$ and $\psi(y) = A_y \cup B_y$. Then ψ is an $(f_{\emptyset}^G, 14t)$ -coloring of G (notice that $f_{\emptyset}^{G'}(z) = 6/14$, while $f_{\emptyset}^G(z) = 5/14$ whenever $z \in \{a, b, c, d\}$). This contradicts the assumption that G is a counterexample.

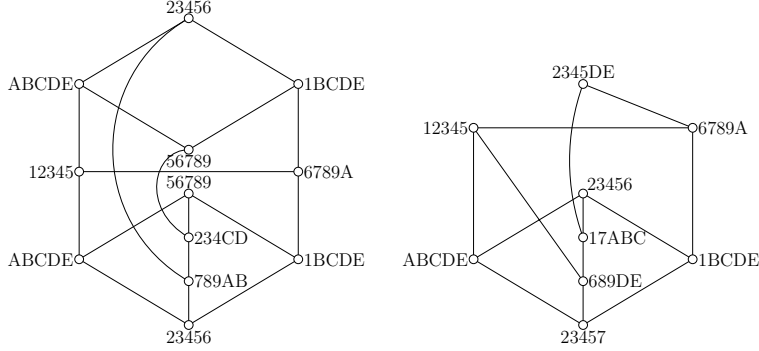

Figure 8: Configurations from Lemma 13.

Finally, it remains to consider the case where G' contains a dangerous induced subgraph H with at most one safe special vertex. As H contains at least two safe vertices in G , we can assume by symmetry that H contains a . Since a has degree two in G' , the subgraph H contains b as well. If H also contains at least one of c and d (and thus both of them), then since G is 2-edge-connected, we conclude that $G' = H$, and H is one of the graphs depicted in Figure 8; however, both have $(f_\emptyset, 14)$ -colorings. Hence, neither c nor d belongs to H , and thus H contains a special vertex that is unsafe in G . Since the case that G contains K'_4 with an unsafe special vertex has already been excluded, it follows that H is a 5-cycle $abb'sa'$, where (by Lemma 12) a' and b' have degree two and s has degree three. Let $G_1 = G - \{u, v, x, y, a, b, a', b'\}$ and $B_1 = \{c, d, s\}$. Note that B_1 is a nail for G_1 , and thus the minimality of G ensures the existence of an $(f_{B_1}, 14t)$ -coloring ψ_1 of G_1 for a positive integer t . By permuting the colors, we can assume that $\psi(c) = \llbracket 5t \rrbracket$ and $\psi(d) = \llbracket 5t + 1, 10t \rrbracket$. Let us extend ψ to G as follows. Set $\psi(v) = \llbracket 9t + 1, 14t \rrbracket$ and $\psi(y) = \llbracket t \rrbracket \cup \llbracket 10t + 1, 14t \rrbracket$. Arbitrarily choose disjoint sets M_a in $\psi(s) \setminus \llbracket 9t + 1, 12t \rrbracket$ and M_b in $\psi(s) \setminus \llbracket t \rrbracket \cup \llbracket 12t + 1, 14t \rrbracket$ each of size $2t$. Choose two disjoint subsets $\psi(a)$ and $\psi(b)$ of $\llbracket 14t \rrbracket$, each of size $5t$, so that $M_a \cup \llbracket t \rrbracket \cup \llbracket 12t + 1, 14t \rrbracket \subseteq \psi(a)$ and $M_b \cup \llbracket 9t + 1, 12t \rrbracket \subseteq \psi(b)$. Note that $|\llbracket t + 1, 9t \rrbracket \setminus \psi(z)| \geq 6t$ for $z \in \{a, b\}$; hence, we can choose for $\psi(u)$ and $\psi(x)$ two sets of size $5t$, both in $\llbracket t + 1, 9t \rrbracket$ and disjoint from $\psi(a)$ and $\psi(b)$, respectively. Furthermore, note that $|\psi(a) \cup \psi(s)| \leq 8t$ and $|\psi(b) \cup \psi(s)| \leq 8t$. It follows that ψ can be extended to a' and b' by Proposition 4. The obtained mapping ψ is an $(f_\emptyset, 14t)$ -coloring of G , which is a contradiction. \square

Lemma 14. *Let G be a minimal counterexample to Theorem 5. Let v be a vertex of G and let x and y be two neighbors of v . Suppose that x and y have degree two, and let x' and y' be their neighbors, respectively, distinct from v . Then $x' \neq y'$ and x' is adjacent to y' .*

Proof. The vertices v , x' and y' have degree three by Lemma 12. Let u be the neighbor of v distinct from x and y . If $x' = y'$, then let $G' = G - x$ and $B' = \{x', v\}$. Since B' is a nail for G' , the minimality of G ensures that there exists an $f_{B'}^{G'}$ -coloring ψ of G' . We can extend ψ to an f_{\emptyset}^G -coloring of G by setting $\psi(x) = \psi(y)$, contradicting the assumption that G is a counterexample.

Therefore, $x' \neq y'$. Our next goal is to prove that u must have degree three. Suppose, on the contrary, that u has degree two, and let u' be the neighbor of u distinct from v . Then u' has degree 3 and, by symmetry, we infer that $x' \neq u' \neq y'$. Let $G' = G - \{u, v, x, y\}$ and let $B' = \{u', x', y'\}$. Since B' is a nail for G' , the minimality of G implies the existence of an $(f_{B'}^{G'}, 14t)$ -coloring ψ of G' for a positive integer t . Note that $|\psi(u')| = |\psi(x')| = |\psi(y')| = 5t$. For $i \in \{1, 2, 3\}$, let S_i be the set of elements of $\llbracket 14t \rrbracket$ that belong to exactly i of the sets $\psi(u')$, $\psi(x')$ and $\psi(y')$. Note that $|S_1| + |S_2| + |S_3| \leq 14t$ and $|S_1| + 2|S_2| + 3|S_3| = 15t$, so $|S_2| + 2|S_3| \geq t$. Let $M \subset S_2 \cup S_3$ be an arbitrary set such that $|M \cap S_2| + 2|M \cap S_3| \geq t$ and $|M| \leq t$. Choose $M_u \subset \psi(u') \setminus M$, $M_x \subset \psi(x') \setminus M$ and $M_y \subset \psi(y') \setminus M$ arbitrarily so that $|M \cap \psi(u')| + |M_u| = |M \cap \psi(x')| + |M_x| = |M \cap \psi(y')| + |M_y| = 2t$, and let $L = M \cup M_u \cup M_x \cup M_y$. Note that $|L| \leq |M| + |M_u| + |M_x| + |M_y| = 6t + |M| - |M \cap \psi(u')| - |M \cap \psi(x')| - |M \cap \psi(y')| = 6t + |M| - 2|M \cap S_2| - 3|M \cap S_3| = 6t - |M \cap S_2| - 2|M \cap S_3| \leq 5t$. Let us choose $\psi(v)$ in $\llbracket 14t \rrbracket$ of size $5t$ such that $L \subseteq \psi(v)$. Note that $|\psi(v) \cap \psi(z)| \geq 2t$ for $z \in \{u', x', y'\}$; hence, ψ can be extended to u , x and y by Proposition 4. This yields an f_{\emptyset} -coloring of G , which is a contradiction. Therefore, u has degree three.

Now suppose, for a contradiction, that x' is not adjacent to y' in G . Then, the graph G' obtained from G by removing x and adding the edge $x'y$ is triangle-free. Let us show that \emptyset is a nail for G' . Consider a dangerous induced subgraph H of G' . If H had at most one safe special vertex in G' , then G' would contain two adjacent vertices a and b of degree two. Note that v is the only vertex of G' of degree two that has degree three in G , and that both neighbors of v in G' have degree three. It follows that a and b have degree two in G as well. Furthermore, y has degree three in G' , thus the edge ab is distinct from $x'y$. Therefore, a and b would be adjacent vertices of

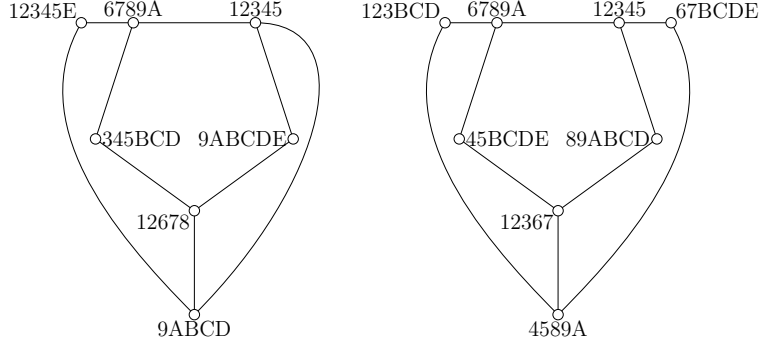

Figure 9: Configurations from Lemma 15.

degree two in G , contrary to Lemma 12.

By the minimality of G , there exists an $(f_{\mathcal{D}}^{G'}, 14t)$ -coloring ψ' of G' for a positive integer t . Proposition 4 yields that $|(\psi'(x') \cup \psi'(y')) \cap \psi'(u)| \leq 3t$. Choose arbitrary sets M_x in $\psi'(x') \setminus \psi'(u)$ and M_y in $\psi'(y') \setminus \psi'(u)$, each of size $2t$. We define a coloring ψ of G as follows. Set $\psi(z) = \psi'(z)$ for each $z \in V(G) \setminus \{x, y, v\}$. Choose $\psi(v)$ in $\llbracket 14t \rrbracket \setminus \psi(u)$ of size $5t$ so that $M_x \cup M_y \subset \psi(v)$. It holds that $|\psi(x') \cap \psi(v)| \geq |M_x| = 2t$ and $|\psi(y') \cap \psi(v)| \geq 2t$; hence, ψ can be extended to x and y by Proposition 4. Observe that ψ is an $(f_{\mathcal{D}}^G, 14t)$ -coloring of G , which is a contradiction. \square

Lemma 15. *If G is a minimal counterexample to Theorem 5, then every vertex of G has at most one neighbor of degree two.*

Proof. Suppose, on the contrary, that a vertex v of G has two distinct neighbors x and y of degree two in G . Let x' and y' be the neighbors of x and y , respectively, distinct from v . Lemma 14 implies that $vx'x'y'y$ is a 5-cycle. Moreover, Lemma 12 implies that x' , y' and v all have degree three. Let u be the neighbor of v distinct from x and y . If u had degree two, then by Lemma 14, its neighbor distinct from v would be adjacent both to x' and y' , and G would contain a triangle. Hence, u has degree three. Let a and b be the neighbors of x' and y' , respectively, not belonging to the path $xx'y'y$ (where possibly $a = u$ or $b = u$).

If say a has degree two, then Lemma 14 yields that a is adjacent to u . By Lemmas 10 and 12, it follows that either $b = u$, or b has degree two and is adjacent to u as well. However, G would then be one of the graphs in

Figure 9, which are both $(f_\emptyset, 14)$ -colorable. Therefore, a has degree three and, by symmetry, so does b .

Let $G' = G - \{x, y, v\}$ and $B' = \{x', y', u\}$. Since B' is a nail for G' , the minimality of G ensures the existence of an $(f_{B'}, 14t)$ -coloring ψ' of G' for a positive integer t . Let $L_v = \llbracket 14t \rrbracket \setminus \psi'(u)$. As $|L_v| = 9t$ and $|\psi'(a)| = |\psi'(b)| = 5t$, we can choose disjoint sets M_a in $L_v \setminus \psi'(a)$ and M_b in $L_v \setminus \psi'(b)$ each of size $2t$. We define a coloring ψ of G as follows. For $z \in V(G) \setminus \{v, x, x', y, y'\}$, set $\psi(z) = \psi'(z)$. Proposition 4 yields that $|\psi'(a) \cap \psi'(b)| \leq 4t$, and thus we can choose $\psi(x')$ in $\llbracket 14t \rrbracket \setminus (\psi'(a) \cup M_b)$ of size $5t$ so that $M_a \subset \psi(x')$ and $|(\psi'(b) \setminus \psi'(a)) \cap \psi(x')| \geq t$. Let $L_{y'} = \llbracket 14t \rrbracket \setminus (\psi(x') \cup \psi(b))$. Note that $M_b \subset L_{y'}$ and $|L_{y'}| \geq 5t$. Choose $\psi(y')$ in $L_{y'}$ of size $5t$ so that $M_b \subset \psi(y')$, and $\psi(v)$ in L_v of size $5t$ so that $M_a \cup M_b \subset \psi(v)$. It follows that $|\psi(v) \cap \psi(x')| \geq |M_a| = 2t$ and $|\psi(v) \cap \psi(y')| \geq |M_b| = 2t$; hence ψ can be extended to x and y as well, by Proposition 4. However, ψ is then an $(f_\emptyset, 14t)$ -coloring of G , which is a contradiction. \square

The following is a direct consequence of Lemmas 12 and 15.

Corollary 16. *In a minimal counterexample to Theorem 5, every 5-cycle contains at least four safe vertices.*

We continue our study of the structure of minimal counterexamples that contain vertices of degree two.

Lemma 17. *Let G be a minimal counterexample to Theorem 5 and let $v \in V(G)$ have degree two. Let x and y be the neighbors of v ; let the neighbors of x distinct from v be a and b , and let the neighbors of y distinct from v be c and d . Then the following hold.*

1. \emptyset is a nail for $G - v$, as well as for $G - \{v, x, y\}$.
2. The vertices a, b, c and d are pairwise distinct.
3. Let $f^{G,v}$ be the function defined by $f^{G,v}(z) = f_\emptyset(z)$ for $z \in V(G) \setminus \{v, x, y, a, b, c, d\}$, $f^{G,v}(z) = 4/14$ for $z \in \{a, b, c, d\}$, $f^{G,v}(x) = f^{G,v}(y) = 8/14$ and $f^{G,v}(v) = 2/14$. Then G has an $f^{G,v}$ -coloring.

Proof. Note that a, b, c and d have degree three by Lemma 15. Let us consider each part of the statement separately.

1. Let G' be either $G - v$ or $G - \{v, x, y\}$ and suppose that H is a dangerous induced subgraph of G' containing at most one safe vertex. Lemma 13 implies

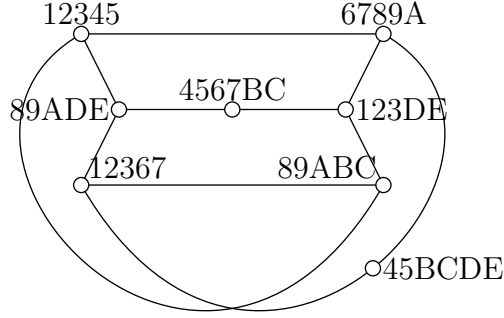

Figure 10: A configuration from Lemma 17.

that H is a 5-cycle. By Corollary 16, at least four of its vertices are safe in G . It follows that H contains at least three vertices that have degree two in G' and degree three in G . There are only two such vertices if $G' = G - v$. Hence, we assume that $G' = G - \{v, x, y\}$. If all vertices of H are safe in G , then $a, b, c, d \in V(H)$; however, the vertex of H distinct from a, b, c and d is then incident with a bridge in G , contrary to Lemma 6.

Let us now consider the case where H contains exactly four vertices of degree three in G . By symmetry, we can assume that $a, b, c \in V(H)$ (let us note that a, b, c and d are pairwise distinct, as three of them belong to H and have degree exactly two). Let u be the vertex of H distinct from a, b and c that is safe in G . If $u \neq d$, then the edge yd together with an edge incident with u form a 2-edge-cut in G . Thus, Lemma 10 implies that d has degree two in G , contrary to Lemma 15. It follows that $u = d$ and G is the graph depicted in Figure 10. However, G is then $(f_\emptyset, 14)$ -colorable, which is a contradiction.

2. Suppose, on the contrary, that $a = c$. Let $G' = G - v$. As argued, \emptyset is a nail for G' , so the minimality of G ensures the existence of an $(f_\emptyset^{G'}, 14t)$ -coloring ψ' of G' for a positive integer t . Note that $f_\emptyset^{G'}(x) = 6/14 = f_\emptyset^{G'}(y)$, while $f_\emptyset^G(x) = 5/14 = f_\emptyset^G(y)$. Let M be an arbitrary subset of $\llbracket 14t \rrbracket \setminus \psi'(a)$ of size t . Define a coloring ψ of G as follows. For $z \in V(G) \setminus \{x, v, y\}$, set $\psi(z) = \psi'(z)$; furthermore, set $\psi(x) = \psi'(x) \setminus M$, $\psi(y) = \psi'(y) \setminus M$ and $\psi(v) = \psi'(a) \cup M$. Then ψ is an $(f_\emptyset^G, 14t)$ -coloring of G , which is a contradiction.

3. Again, let $G' = G - v$ and let ψ' be an $(f_\emptyset^{G'}, 14t)$ -coloring of G' . As $|\psi'(x)| = 6t = |\psi'(y)|$, there exists a subset M of $\llbracket 14t \rrbracket \setminus (\psi'(x) \cup \psi'(y))$ of size $2t$. Let $S_a = \psi'(a) \setminus (\psi'(b) \cup M)$, $S_b = \psi'(b) \setminus (\psi'(a) \cup M)$ and

$S_{ab} = (\psi'(a) \cap \psi'(b)) \setminus M$; note that $3t \leq |S_a| + |S_{ab}| \leq 5t$ and $3t \leq |S_b| + |S_{ab}| \leq 5t$. Furthermore, since $\psi'(x)$ has size $6t$ and is disjoint from $M \cup \psi'(a) \cup \psi'(b)$, it follows that $14t - |M| - |S_a| - |S_{ab}| - |S_b| \geq 6t$, i.e., $|S_a| + |S_{ab}| + |S_b| \leq 6t$. Our next goal is to choose a set X in $\llbracket 14t \rrbracket \setminus M$ of size $8t$ such that $|X \cap \psi'(a)| \leq t$ and $|X \cap \psi'(b)| \leq t$. To this end, we consider several cases, regarding the sizes of S_a and S_b . If $|S_a| \geq t$ and $|S_b| \geq t$, then choose X so that $|X \cap S_a| = |X \cap S_b| = t$ and $X \cap S_{ab} = \emptyset$. Otherwise, by symmetry, we can assume that $|S_a| < t$; consequently, $|S_{ab}| \geq 3t - |S_a| > 2t$. If $|S_b| \geq t$, then let X consist of $7t$ elements of $\llbracket 14t \rrbracket \setminus (M \cup \psi'(b))$ and t elements of S_b . Finally, if both S_a and S_b have less than t elements, say $|S_a| \leq |S_b| < t$, then let X consist of $S_a \cup S_b$ together with $t - |S_b|$ elements of S_{ab} and $8t - |S_a| - |S_b| - (t - |S_b|) = 7t - |S_a|$ elements of $\llbracket 14t \rrbracket \setminus (M \cup \psi'(a) \cup \psi'(b))$; this is possible, since $|\llbracket 14t \rrbracket \setminus (M \cup \psi'(a) \cup \psi'(b))| = 12t - |S_a| - (|S_b| + |S_{ab}|) \geq 7t - |S_a|$. In each case, $|X \cap \psi'(z)| \leq t$ for $z \in \{a, b\}$, as desired. Symmetrically, there exists a set Y in $\llbracket 14t \rrbracket \setminus M$ such that $|Y \cap \psi'(z)| \leq t$ for $z \in \{c, d\}$.

An $(f^{G,v}, 14t)$ -coloring of G is now obtained as follows. Set $\psi(z) = \psi'(z)$ for $z \in V(G) \setminus \{a, b, c, d, v, x, y\}$, $\psi(x) = X$, $\psi(v) = M$, $\psi(y) = Y$, $\psi(a) = \psi'(a) \setminus X$, $\psi(b) = \psi'(b) \setminus X$, $\psi(c) = \psi'(c) \setminus Y$ and $\psi(d) = \psi'(d) \setminus Y$. \square

Lemma 18. *Every minimal counterexample to Theorem 5 is 3-regular.*

Proof. Suppose, on the contrary, that G is a minimal counterexample containing a vertex v of degree two. By Lemmas 12 and 15, all the other vertices of G at distance at most two from v have degree three. Let x and y be the neighbors of v ; let the neighbors of x distinct from v be a and b , and let the neighbors of y distinct from b be c and d . By Lemma 17, the vertices a, b, c and d are pairwise distinct.

In order to obtain a contradiction, we show that G is f_\emptyset -colorable. To do so, we use the equivalent statement given by Theorem 3(d). Let us consider an arbitrary non-negative weight function w for G . We need to show that G contains an independent set X with $w(X) \geq w_{f_\emptyset}$. Let $w_2 = w(a) + w(b) + w(c) + w(d)$.

Assertion 1. *G contains an independent set X_0 satisfying*

$$w(X_0) \geq w_{f_\emptyset} + \frac{1}{14}(w_2 - 3w(x) - 3w(y) + 4w(v)).$$

Proof. We discuss several cases depending on the values of w on vertices at distance at most two from v . By symmetry, we assume that $w(x) \leq w(y)$. Let $G' = G - \{v, x, y\}$, and recall that \emptyset is a nail for G' by Lemma 17.

Suppose first that $w(y) \leq w(v)$. Note that $w_{f_{\emptyset}^{G'}} = w_{f_{\emptyset}^G} + \frac{1}{14}(6w(a) - 5w(a) + 6w(b) - 5w(b) + 6w(c) - 5w(c) + 6w(d) - 5w(d) - 5w(x) - 5w(y) - 6w(v)) = w_{f_{\emptyset}^G} + \frac{1}{14}(w_2 - 5w(x) - 5w(y) - 6w(v))$. By the minimality of G , there exists an independent set P of G' with $w(P) \geq w_{f_{\emptyset}^{G'}}$. Let $X_0 = P \cup \{v\}$ and note that X_0 is an independent set of G such that

$$\begin{aligned}
w(X_0) &= w(P) + w(v) \geq w_{f_{\emptyset}^{G'}} + w(v) \\
&= w_{f_{\emptyset}^G} + \frac{1}{14}(w_2 - 5w(x) - 5w(y) - 6w(v)) + w(v) \\
&= w_{f_{\emptyset}^G} + \frac{1}{14}(w_2 - 5w(x) - 5w(y) + 8w(v)) \\
&= w_{f_{\emptyset}^G} + \frac{1}{14}(w_2 - 3w(x) - 3w(y) + 4w(v)) \\
&\quad + \frac{2}{14}(w(v) - w(x)) + \frac{2}{14}(w(v) - w(y)) \\
&\geq w_{f_{\emptyset}^G} + \frac{1}{14}(w_2 - 3w(x) - 3w(y) + 4w(v)).
\end{aligned}$$

Next, suppose that $w(x) \leq w(v) < w(y)$. Let w' be the (not necessarily non-negative) weight function defined as follows: set $w'(z) = w(z)$ for $z \in V(G) \setminus \{c, d, v, x, y\}$, $w'(c) = w(c) - w(y) + w(v)$ and $w'(d) = w(d) - w(y) + w(v)$. Note that $w'_{f_{\emptyset}^{G'}} = w_{f_{\emptyset}^G} + \frac{1}{14}(6w'(a) - 5w(a) + 6w'(b) - 5w(b) + 6w'(c) - 5w(c) + 6w'(d) - 5w(d) - 5w(x) - 5w(y) - 6w(v)) = w_{f_{\emptyset}^G} + \frac{1}{14}(w_2 - 5w(x) - 17w(y) + 6w(v))$. By the minimality of G , there exists an independent set P of G' with $w'(P) \geq w'_{f_{\emptyset}^{G'}}$. Let X_0 be defined as follows: if $\{c, d\} \cap P \neq \emptyset$, then let $X_0 = P \cup \{v\}$, otherwise let $X_0 = P \cup \{y\}$. In the latter case, $w(X_0) = w'(P) + w(y)$. In the former case (say $c \in P$), it holds that $w(X_0) \geq w'(P) + (w(c) - w'(c)) + w(v) = w'(P) + w(y)$ (the inequality holds, since if d also belongs to P , then the right side changes by $w(d) - w'(d) =$

$w(y) - w(v) > 0$). It follows that

$$\begin{aligned}
w(X_0) &\geq w'(P) + w(y) \geq w'_{f_{\mathcal{G}'}} + w(y) \\
&= w_{f_{\mathcal{G}}} + \frac{1}{14}(w_2 - 5w(x) - 17w(y) + 6w(v)) + w(y) \\
&= w_{f_{\mathcal{G}}} + \frac{1}{14}(w_2 - 5w(x) - 3w(y) + 6w(v)) \\
&= w_{f_{\mathcal{G}}} + \frac{1}{14}(w_2 - 3w(x) - 3w(y) + 4w(v) + 2(w(v) - w(x))) \\
&\geq w_{f_{\mathcal{G}}} + \frac{1}{14}(w_2 - 3w(x) - 3w(y) + 4w(v)).
\end{aligned}$$

Finally, assume that $w(v) < w(x) \leq w(y)$. Let w' be the (not necessarily non-negative) weight function defined as follows: set $w'(z) = w(z)$ for $z \in V(G) \setminus \{a, b, c, d, v, x, y\}$, $w'(a) = w(a) - w(x) + w(v)$, $w'(b) = w(b) - w(x) + w(v)$, $w'(c) = w(c) - w(y) + w(v)$ and $w'(d) = w(d) - w(y) + w(v)$. Note that $w'_{f_{\mathcal{G}'}} = w_{f_{\mathcal{G}}} + \frac{1}{14}(6w'(a) - 5w(a) + 6w'(b) - 5w(b) + 6w'(c) - 5w(c) + 6w'(d) - 5w(d) - 5w(x) - 5w(y) - 6w(v)) = w_{f_{\mathcal{G}}} + \frac{1}{14}(w_2 - 17w(x) - 17w(y) + 18w(v))$. By the minimality of G , there exists an independent set P of G' with $w'(P) \geq w'_{f_{\mathcal{G}'}}$. We now show that there exists an independent set X_0 of G such that $w(X_0) \geq w'(P) + w(x) + w(y) - w(v)$. Indeed, if $\{a, b\} \cap P \neq \emptyset$ and $\{c, d\} \cap P \neq \emptyset$ (say $a \in P$ and $c \in P$), then set $X_0 = P \cup \{v\}$. It follows that $w(X_0) \geq w'(P) + (w(a) - w'(a)) + (w(c) - w'(c)) + w(v) = w'(P) + w(x) + w(y) - w(v)$, as wanted. If $\{a, b\} \cap P \neq \emptyset$ (say $a \in P$) and $\{c, d\} \cap P = \emptyset$, then let $X_0 = P \cup \{y\}$. It follows that $w(X_0) \geq w'(P) + (w(a) - w'(a)) + w(y) = w'(P) + w(x) + w(y) - w(v)$, as wanted. Similarly, if $\{a, b\} \cap P = \emptyset$ and $\{c, d\} \cap P \neq \emptyset$, then let $X_0 = P \cup \{x\}$ and observe that $w(X_0) \geq w'(P) + w(x) + w(y) - w(v)$. Finally, if $\{a, b\} \cap P = \emptyset$ and $\{c, d\} \cap P = \emptyset$, then let $X_0 = P \cup \{x, y\}$. It follows that $w(X_0) = w'(P) + w(x) + w(y) \geq w'(P) + w(x) + w(y) - w(v)$. In conclusion,

$$\begin{aligned}
w(X_0) &\geq w'(P) + w(x) + w(y) - w(v) \\
&\geq w'_{f_{\mathcal{G}'}} + w(x) + w(y) - w(v) \\
&= w_{f_{\mathcal{G}}} + \frac{1}{14}(w_2 - 17w(x) - 17w(y) + 18w(v)) + w(x) + w(y) - w(v) \\
&= w_{f_{\mathcal{G}}} + \frac{1}{14}(w_2 - 3w(x) - 3w(y) + 4w(v)).
\end{aligned}$$

Therefore, in all the cases the set X_0 has the required weight. \square

By Lemma 17, the graph G has an $(f^{G,v}, 14t)$ -coloring ψ for a positive integer t . For $i \in \llbracket 14t \rrbracket$, let $X_i = \{z \in V(G) : i \in \psi(z)\}$; note that X_i is an independent set of G and

$$\begin{aligned}
\frac{1}{14t} \sum_{i=1}^{14t} w(X_i) &= \sum_{z \in V(G)} f^{G,v}(z)w(z) \\
&= \sum_{z \in \{a,b,c,d,x,y,v\}} (f^{G,v}(z) - f_{\emptyset}(z))w(z) + \sum_{z \in V(G)} f_{\emptyset}(z)w(z) \\
&= \frac{1}{14}(-w_2 + 3w(x) + 3w(y) - 4w(v)) + \sum_{z \in V(G)} f_{\emptyset}(z)w(z) \\
&= w_{f_{\emptyset}} + \frac{1}{14}(-w_2 + 3w(x) + 3w(y) - 4w(v)).
\end{aligned}$$

Together with Assertion 1, this implies that $w(X_i) \geq w_{f_{\emptyset}}$ for some $i \in \llbracket 0, 14t \rrbracket$. Since this holds for every non-negative weight function for G , we conclude that G has an f_{\emptyset}^G -coloring, which is a contradiction. \square

Lemma 19. *Every minimal counterexample to Theorem 5 has girth at least five.*

Proof. Suppose, on the contrary, that G is a minimal counterexample that contains a 4-cycle $uvxy$. Let a, c, b and d be the neighbors of u, v, x and y , respectively, outside this 4-cycle.

Since G is triangle-free, $\{a, b\} \cap \{c, d\} = \emptyset$. If $a = b$, then u and x have the same neighborhood in G but they are not adjacent. The set $B = \{a, v, y\}$ being a nail for $G - u$, the minimality of G implies that $G - u$ has an f_B -coloring ψ . Setting $\psi(u) = \psi(x)$ yields an f_{\emptyset} -coloring of G , which is a contradiction.

Therefore, $a \neq b$ and, symmetrically, $c \neq d$. It follows that a, b, c and d are pairwise distinct. Let $G' = G - \{u, v, x, y\}$. Consider a dangerous induced subgraph H of G' . Lemma 13 implies that H is a 5-cycle. Furthermore, by Lemma 6, not all of a, b, c and d belong to $V(H)$, as otherwise the vertex of H distinct from a, b, c and d would be incident with a bridge. Therefore, H contains at least two vertices of degree three in G' . It follows that \emptyset is a nail for G' . By the minimality of G , there exists an $(f_{\emptyset}^{G'}, 14t)$ -coloring ψ' of G' for a positive integer t . Let $A_u, A_v, A_x, A_y, B_u, B_v, B_x$ and B_y be defined in the same way as in the proof of Lemma 13. Let ψ be the coloring of G defined by $\psi(z) = \psi'(z)$ for $z \in V(G) \setminus \{a, b, c, d, u, v, x, y\}$,

$\psi(a) = \psi'(a) \setminus B_u$, $\psi(b) = \psi'(b) \setminus B_x$, $\psi(c) = \psi'(c) \setminus B_v$, $\psi(d) = \psi'(d) \setminus B_y$,
 $\psi(u) = A_u \cup B_u$, $\psi(v) = A_v \cup B_v$, $\psi(x) = A_x \cup B_x$ and $\psi(y) = A_y \cup B_y$. Then
 ψ is an $(f_{\emptyset}^G, 14t)$ -coloring of G , which is a contradiction. \square

Finally, we are ready to prove our main result.

Proof of Theorem 5. If Theorem 5 were false, there would exist a subcubic triangle-free graph G with a nail B forming a minimal counterexample to Theorem 5. Then, Lemma 8 implies that $B = \emptyset$, while Lemmas 18 and 19 yield that G is 3-regular and contains no 4-cycles.

Let w be any non-negative weight function for G . For $u, v \in V(G)$, let $d(u, v)$ be the length of a shortest path between u and v . For a vertex $v \in V(G)$, let

$$W_v = 9w(v) - 5 \sum_{u: d(u,v)=1} w(u) + \sum_{u: d(u,v)=2} w(u).$$

Since G is 3-regular and has girth at least five, for each $u \in V(G)$, there are exactly three vertices v with $d(u, v) = 1$ and exactly six vertices with $d(u, v) = 2$; consequently,

$$\begin{aligned} \sum_{v \in V(G)} W_v &= 9 \sum_{v \in V(G)} w(v) - 5 \sum_{v \in V(G)} \sum_{u: d(u,v)=1} w(u) + \sum_{v \in V(G)} \sum_{u: d(u,v)=2} w(u) \\ &= 9 \sum_{v \in V(G)} w(v) - 5 \sum_{u \in V(G)} \sum_{v: d(u,v)=1} w(u) + \sum_{u \in V(G)} \sum_{v: d(u,v)=2} w(u) \\ &= 9 \sum_{v \in V(G)} w(v) - 5 \sum_{u \in V(G)} 3w(u) + \sum_{u \in V(G)} 6w(u) \\ &= (9 - 15 + 6) \sum_{v \in V(G)} w(v) \\ &= 0. \end{aligned}$$

Therefore, there exists a vertex $v \in V(G)$ such that $W_v \geq 0$. Let u_1, u_2 and u_3 be the neighbors of v , and let x_1, \dots, x_6 be the six vertices of G at distance exactly 2 from v . Set $G' = G - \{v, u_1, u_2, u_3\}$. Consider a dangerous induced subgraph H of G . By Lemma 13, we know that H is a 5-cycle. Let $S = V(H) \cap \{x_1, \dots, x_6\}$. If $|S| \geq 4$, then at least two of the vertices in S have a common neighbor among u_1, u_2 and u_3 . By symmetry, assume that u_1 is adjacent to both x_1 and x_2 . Since G is triangle-free, x_1 is not adjacent to x_2 ,

and thus these two vertices also have a common neighbor in H . Consequently, G contains a 4-cycle, which is a contradiction. Therefore, each dangerous induced subgraph of G' contains at least two special vertices of degree three. It follows that \emptyset is a nail for G' .

Note that $w_{f_{\emptyset}^{G'}} = w_{f_{\emptyset}^G} + \frac{1}{14}(6 \sum_{i=1}^6 w(x_i) - 5 \sum_{i=1}^6 w(x_i) - 5 \sum_{i=1}^3 w(u_i) - 5w(v)) = w_{f_{\emptyset}^G} + \frac{1}{14}(W_v - 14w(v))$. By the minimality of G and Theorem 3, there exists an independent set P of G' such that $w(P) \geq w_{f_{\emptyset}^{G'}}$. Let $X = P \cup \{v\}$. Then

$$\begin{aligned} w(X) &= w(P) + w(v) \\ &\geq w_{f_{\emptyset}^{G'}} + w(v) \\ &= w_{f_{\emptyset}^G} + \frac{1}{14}(W_v - 14w(v)) + w(v) \\ &= w_{f_{\emptyset}^G} + \frac{1}{14}W_v \\ &\geq w_{f_{\emptyset}^G}. \end{aligned}$$

Therefore, for every non-negative weight function w for G , there exists an independent set X of G such that $w(X) \geq w_{f_{\emptyset}^G}$. By Theorem 3, we conclude that G has an f_{\emptyset}^G -coloring. This is a contradiction, showing that there exists no counterexample to Theorem 5. \square

4 Conclusion

In order to prove Theorem 5, we used several equivalent definitions of (weighted) fractional colorings. As a consequence, our proof is not constructive and the following questions are open.

Problem 20. *Does there exist a polynomial-time algorithm to find a fractional 14/5-coloring of a given input subcubic triangle-free graph?*

We pause here to note that, in general, even if a graph is known to have fractional chromatic number at most r and, thus, an $(rN : N)$ -coloring for some integer N , it is not even clear whether such a coloring can be written in polynomial space. Indeed, all such values of N may be exponential in the number of vertices, as is the case, e.g., for the Mycielsky graphs [15]. This issue would be avoided if the answer to the following question is positive.

Problem 21. *Does there exist an integer t such that every subcubic triangle-free graph has a $(14t : 5t)$ -coloring?*

References

- [1] ALBERTSON, M. O. A lower bound for the independence number of a planar graph. *J. Combinatorial Theory Ser. B* 20, 1 (1976), 84–93.
- [2] ALBERTSON, M. O., BOLLOBAS, B., AND TUCKER, S. The independence ratio and maximum degree of a graph. In *Proceedings of the Seventh Southeastern Conference on Combinatorics, Graph Theory, and Computing* (1976), Utilitas Math., pp. 43–50. Congressus Numerantium, No. XVII.
- [3] APPEL, K., AND HAKEN, W. Every planar map is four colorable. I. Discharging. *Illinois J. Math.* 21, 3 (1977), 429–490.
- [4] APPEL, K., AND HAKEN, W. *Every planar map is four colorable*, vol. 98 of *Contemporary Mathematics*. American Mathematical Society, Providence, RI, 1989. With the collaboration of J. Koch.
- [5] APPEL, K., HAKEN, W., AND KOCH, J. Every planar map is four colorable. II. Reducibility. *Illinois J. Math.* 21, 3 (1977), 491–567.
- [6] FAJTLOWICZ, S. On the size of independent sets in graphs. *Congr. Numer.* 21 (1978), 269–274.
- [7] FERGUSON, D., KAISER, T., AND KRÁL', D. The fractional chromatic number of triangle-free subcubic graphs. Submitted for publication. arXiv:1203.1308.
- [8] GRÖTZSCH, H. Zur Theorie der diskreten Gebilde. VII. Ein Dreifarbensatz für dreikreisfreie Netze auf der Kugel. *Wiss. Z. Martin-Luther-Univ. Halle-Wittenberg. Math.-Nat. Reihe* 8 (1958/1959), 109–120.
- [9] HATAMI, H., AND ZHU, X. The fractional chromatic number of graphs of maximum degree at most three. *SIAM J. Discrete Math.* 23 (2009), 1162–1175.

- [10] HECKMAN, C. C., AND THOMAS, R. A new proof of the independence ratio of triangle-free cubic graphs. *Discrete Math.* 233 (2001), 233–237.
- [11] HECKMAN, C. C., AND THOMAS, R. Independent sets in triangle-free cubic planar graphs. *J. Combin. Theory Ser. B* 96, 2 (2006), 253–275. doi:10.1016/j.jctb.2005.07.009.
- [12] HILTON, A. J. W., RADO, R., AND SCOTT, S. H. A (< 5)-colour theorem for planar graphs. *Bull. London Math. Soc.* 5 (1973), 302–306.
- [13] JONES, K. F. Independence in graphs with maximum degree four. *J. Combin. Theory Ser. B* 37, 3 (1984), 254–269. doi:10.1016/0095-8956(84)90058-3.
- [14] JONES, K. F. Size and independence in triangle-free graphs with maximum degree three. *J. Graph Theory* 14, 5 (1990), 525–535.
- [15] LARSEN, M., PROPP, J., AND ULLMAN, D. The fractional chromatic number of Mycielski’s graphs. *J. Graph Theory* 19 (1995), 411–416.
- [16] LIU, C.-H. An upper bound on the fractional chromatic number of triangle-free subcubic graphs. Submitted for publication.
- [17] LU, L., AND PENG, X. The fractional chromatic number of triangle-free graphs with $\Delta \leq 3$. *Discrete Math.* 312 (2012), 3502–3516.
- [18] ROBERTSON, N., SANDERS, D. P., SEYMOUR, P., AND THOMAS, R. A new proof of the four-colour theorem. *Electron. Res. Announc. Amer. Math. Soc.* 2, 1 (1996), 17–25 (electronic). doi:10.1090/S1079-6762-96-00003-0.
- [19] SCHEINERMAN, E. R., AND ULLMAN, D. H. *Fractional graph theory*. Wiley-Interscience Series in Discrete Mathematics and Optimization. John Wiley & Sons Inc., New York, 1997.
- [20] STATON, W. Some ramsey-type numbers and the independence ratio. *Trans. Amer. Math. Soc.* 256 (1979), 353–370.
- [21] STEINBERG, R., AND TOVEY, C. A. Planar Ramsey numbers. *J. Combin. Theory Ser. B* 59, 2 (1993), 288–296. doi:10.1006/jctb.1993.1070.

- [22] TUZA, Z., AND VOIGT, M. Every 2-choosable graph is $(2m, m)$ -choosable. *J. Graph Theory* 22, 3 (1996), 245–252.