



HAL
open science

The joy of string diagrams

Pierre-Louis Curien

► **To cite this version:**

Pierre-Louis Curien. The joy of string diagrams. Computer Science Logic, Sep 2008, Bertinoro, Italy. pp.15-22. hal-00697115

HAL Id: hal-00697115

<https://hal.science/hal-00697115v1>

Submitted on 14 May 2012

HAL is a multi-disciplinary open access archive for the deposit and dissemination of scientific research documents, whether they are published or not. The documents may come from teaching and research institutions in France or abroad, or from public or private research centers.

L'archive ouverte pluridisciplinaire **HAL**, est destinée au dépôt et à la diffusion de documents scientifiques de niveau recherche, publiés ou non, émanant des établissements d'enseignement et de recherche français ou étrangers, des laboratoires publics ou privés.

The Joy of String Diagrams

Pierre-Louis Curien

Preuves, Programmes et Systèmes, CNRS and University Paris 7

May 14, 2012

Abstract

In the past recent years, I have been using string diagrams to teach basic category theory (adjunctions, Kan extensions, but also limits and Yoneda embedding). Using graphical notations is undoubtedly joyful, and brings us close to other graphical syntaxes of circuits, interaction nets, etc... It saves us from laborious verifications of naturality, which is built-in in string diagrams. On the other hand, the language of string diagrams is more demanding in terms of typing: one may need to introduce explicit coercions for equalities of functors, or for distinguishing a morphism from a point in the corresponding internal homset. So that in some sense, string diagrams look more like a language "à la Church", while the usual mathematics of, say, Mac Lane's "Categories for the working mathematician" are more "à la Curry".

Natural transformations are traditionally represented as pasting diagrams, where natural transformations $\mu : F \rightarrow F'$ appear as surfaces between an upper border F and a lower border F' . But the dual notation of string diagrams turns out to be more adapted to formal manipulations. In this notation, the Godement's rule, which says that the pasting diagram obtained by putting aside $\mu : F \rightarrow F'$ and $\nu : G \rightarrow G'$ makes sense, i.e., can be parsed indifferently as the vertical composition $(\nu F') \circ (G\mu)$ or the vertical composition $(G'\mu) \circ (\nu F)$ – has a "physical" translation in terms of "moving elevators" up and down. The respective parsings are, indeed, represented as

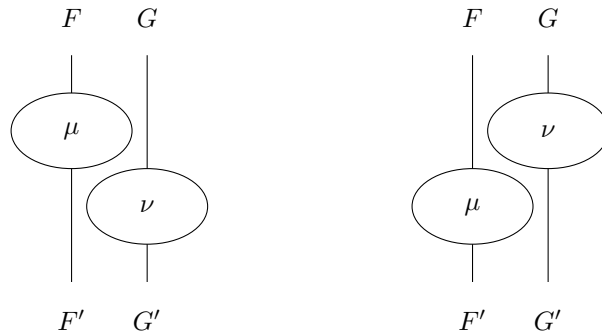

and

Hence, the underlying naturality equations remain explicit, in the form of suitable deformations of diagrams.

In string diagrams, functors are 1-dimensional (like in the pasting diagrams), natural transformations are 0-dimensional (think of the circle around μ, ν as just a node in a graph). As for the categories, if $F : \mathbf{C} \rightarrow \mathbf{C}'$, $G : \mathbf{C}' \rightarrow \mathbf{C}''$, and $H : \mathbf{C} \rightarrow \mathbf{C}''$, then, seeing the edges of the graph as half-lines, the diagram below representing a natural transformation $\mu : GF \rightarrow H$ (we write freely GF for $G \circ F$) delineates three regions, corresponding to the three categories. In other words, in this representation, categories are 2-dimensional.

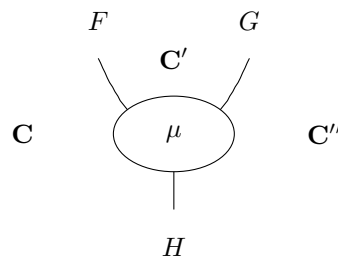

The situation is thus Poincaré dual to that of pasting diagrams:

	categories	functors	natural transformations
pasting diagrams	0	1	2
string diagrams	2	1	0

Another strong point of string diagrams is that they allow us to deal with identity functors and natural transformations implicitly. We represent, say, $\mu : id \rightarrow F$ (with $F : \mathbf{C} \rightarrow \mathbf{C}$), and $id : G \rightarrow G$ (with $G : \mathbf{C} \rightarrow \mathbf{C}'$) as

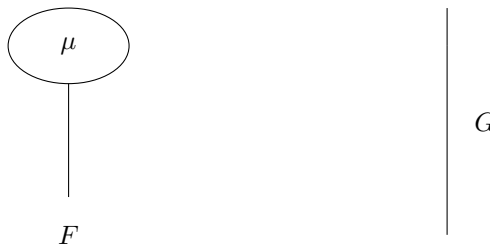

and

respectively.

String diagrams are related to boolean circuits, interaction nets, etc... (see e.g. <http://iml.univ-mrs.fr/~lafont>). We use string diagrams (originally designed and used in

the setting of monoidal categories, Hopf algebras, quantum groups, etc... , see e.g. [2]) not only for the 2-categorical machinery of adjunctions and monads, but also for recasting other basic material of category theory [3]. In this extended abstract, we content ourselves with pointing out the underlying coercions that we have to make explicit in order to treat this material graphically (see [1] for more joy!).

1 Hom-functors

We first notice that we can also use string diagrams to describe morphisms $f : A \rightarrow B$ in a category \mathbf{C} . It suffices to see A and B as functors from the terminal category $\mathbf{1}$ to \mathbf{C} , yielding

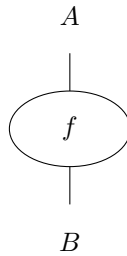

with the left and right half plane corresponding to $\mathbf{1}$ and \mathbf{C} . For Ff , by definition of the horizontal composition of natural transformations, we can write indifferently (i.e., we can use the following as a valid transformation of string diagrams):



or

But we can also view a morphism $f : A \rightarrow B$ as a morphism $\overline{f} : \mathbf{1} \rightarrow \mathbf{C}[A, B]$ in \mathbf{Set} (the category of sets and functions). We use overlining to make the coercion explicit between the two representations. Then it turns out that the action of the hom functors can be described through the following equations:

EQUATION *Homleft*:

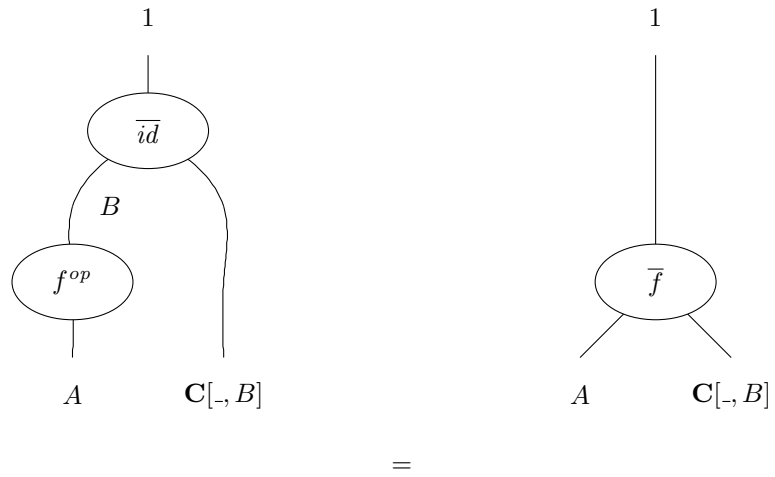

EQUATION *Homright*:

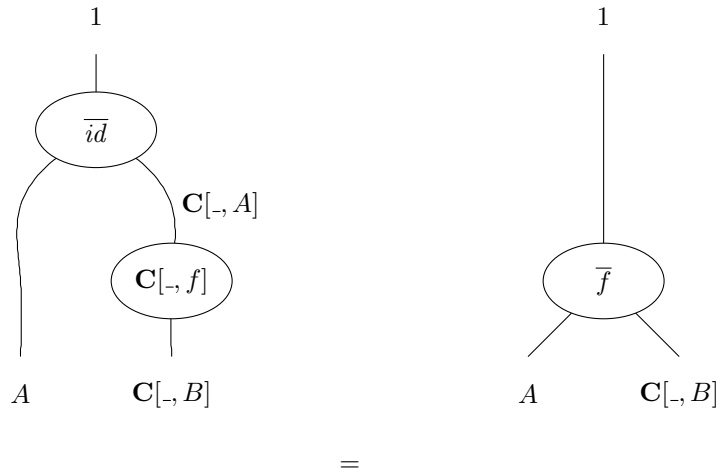

One can give graphical proofs of Yoneda lemma, and of the density of representable presheaves: every functor $F : \mathbf{C}^{op} \rightarrow \mathbf{Set}$ is the colimit of functors of the form $\mathbf{C}[-, C]$.

2 Limits

Recall that, given a diagram $D : \mathbf{I} \rightarrow \mathbf{C}$, a cone from an object C can be described as a natural transformation from ΔC to D , where $\Delta : \mathbf{C} \rightarrow \mathbf{C}^{\mathbf{I}}$ is the curried form of the first projection functor from $\mathbf{C} \times \mathbf{I}$ to \mathbf{C} . This indicates that we should draw D as a functor from $\mathbf{1}$ to $\mathbf{C}^{\mathbf{I}}$. On the other hand, if we want to talk e.g. of preservation of limits, we need to deal with FD , for some functor $F : \mathbf{C} \rightarrow \mathbf{C}'$, and then we will have to view D as a functor from \mathbf{I} to \mathbf{C} . Under this guise, we denote it as \underline{D} .

Note that in any cartesian closed category, there is a bijective correspondence between the morphisms from A to B and the points of B^A , i.e., the morphisms from $\mathbf{1}$ to B^A . We use here underlining as an *explicit coercion* from the latter to the former.

Graphically, we introduce boxes of the following kind:

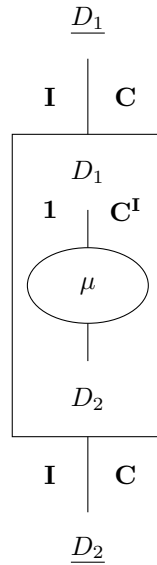

where the contents of the box is a string diagram living in $\mathbf{Cat}[\mathbf{1}, \mathbf{C}^{\mathbf{I}}]$ (where \mathbf{Cat} is the category of categories) while the whole diagram, once coerced, lives in $\mathbf{Cat}[\mathbf{I}, \mathbf{C}]$, and can be inserted in a larger diagram (e.g. by placing a wire $F : \mathbf{C} \rightarrow \mathbf{C}'$ on the right).

We have the following law of commutation between coercion and composition:

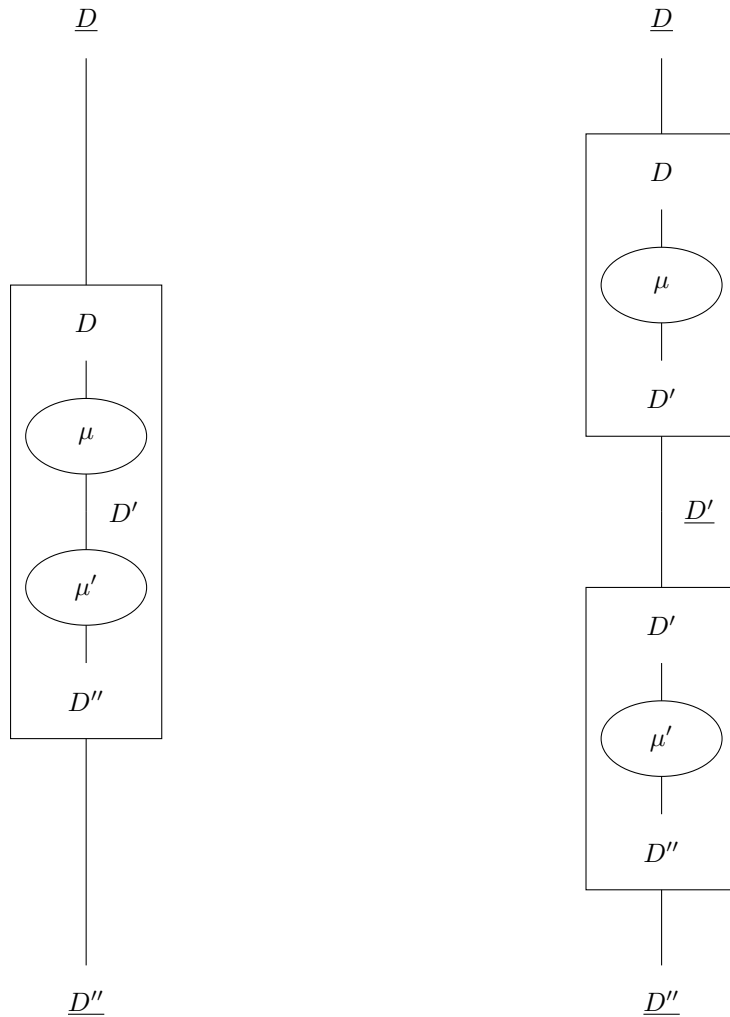

= (1)

As an illustration, given a functor $F : \mathbf{C} \rightarrow \mathbf{C}'$, we show how to describe the action of the functor $F^{\mathbf{I}} : \mathbf{C}^{\mathbf{I}} \rightarrow \mathbf{C}'^{\mathbf{I}}$ on morphisms:

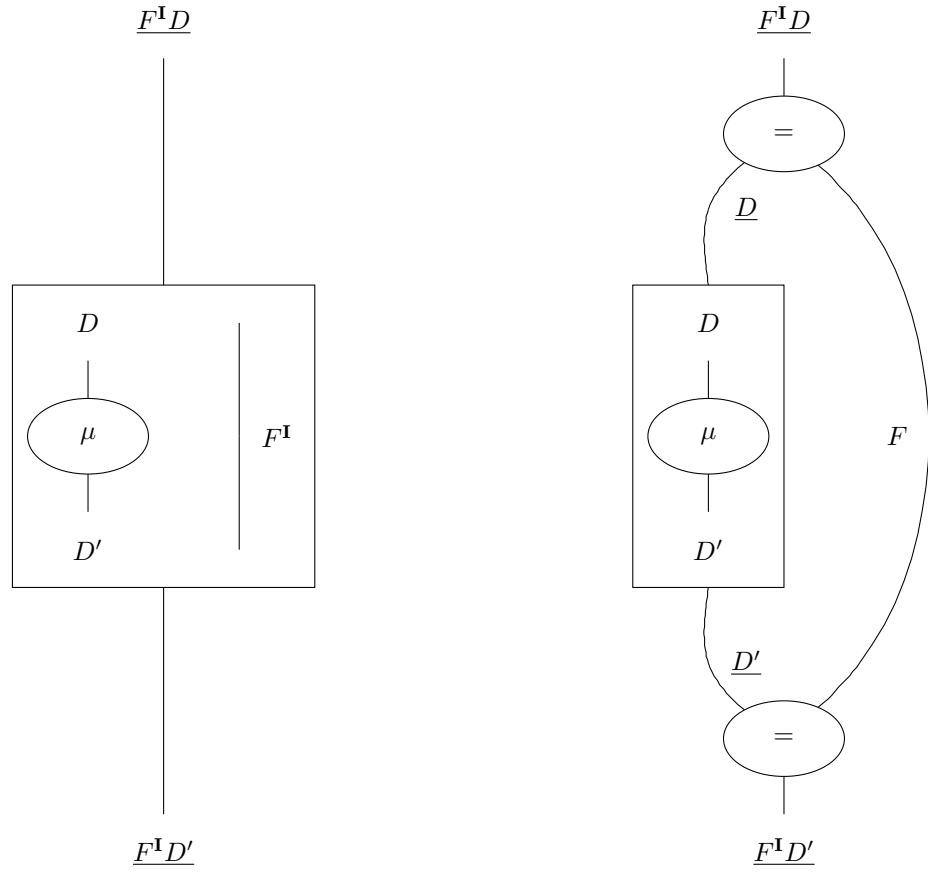

=

(2)

Notice the introduction of explicit equality nodes on the right hand side, which in fact describe the action of F^I on objects:

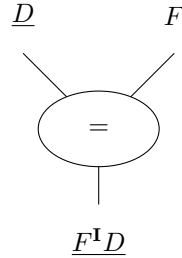
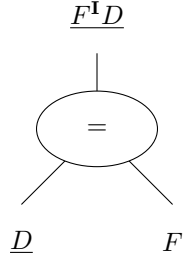

and

One can give graphical proofs of facts and results such as: if $F \dashv G$ (i.e.. F is left adjoint to G), then $F^I \dashv G^I$, or: right adjoints preserve limits.

3 Explicit equalities

In the previous section, we have introduced explicit equality nodes, that allowed us to give the same interface to both sides of the equation describing the behaviour of F^I (respecting the interfaces is a key matter in 2-dimensional proofs). In this (final) section, we state a “coherence” result for string diagrams written only using equality nodes, which we call equality diagrams. We impose, besides associativity, the following three axioms:

We do not require the converse, i.e.

$$(\text{=} : H \rightarrow GF) \circ (\text{=} : GF \rightarrow H) = (\text{id} : G \rightarrow G) \cdot (\text{id} : F \rightarrow F)$$

for two reasons:

1. The most general type for the left hand side is $(=: H \rightarrow G_1F_1) \circ (=: G_2F_2 \rightarrow H)$, with no other requirement than $G_1F_1 = H = G_2F_2$. This contrasts with the situation above, where the plugging of $(=: H \rightarrow G_1F_1)$ above $(=: G_2F_2 \rightarrow H)$ forces $F_1 = F_2$ and $G_1 = G_2$.
2. We can have the effect of this equation by inserting it in a context (plugging $(=: H \rightarrow GF)$ above and $(=: GF \rightarrow H)$ below).

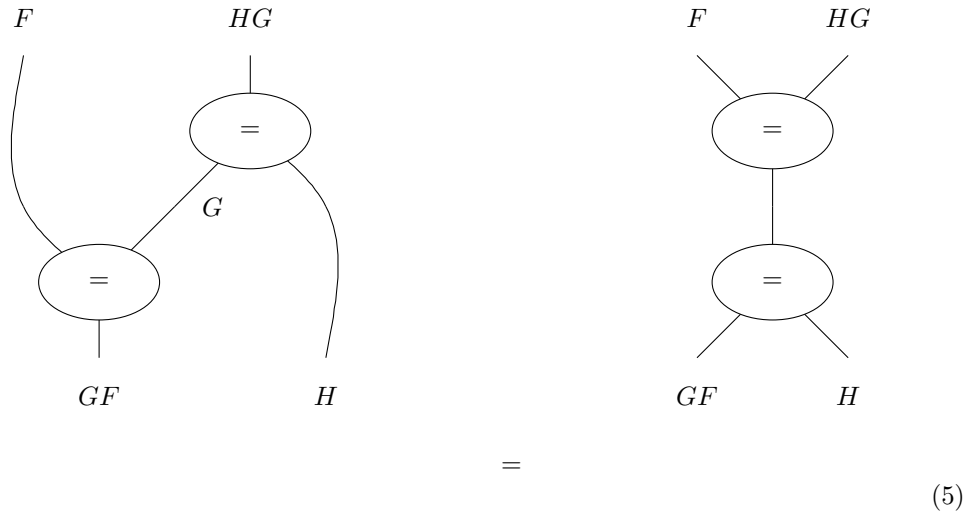
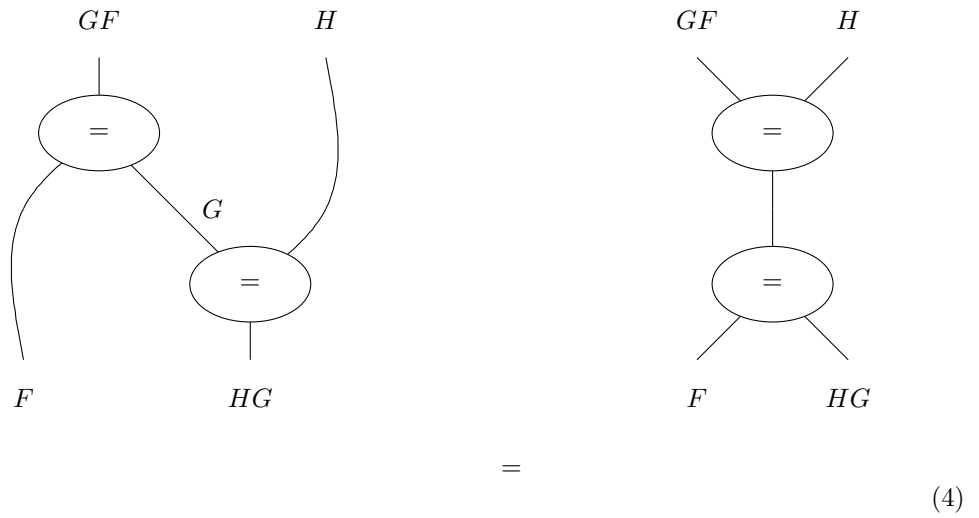

These equations suffice to prove that all equality diagrams with the same interface (given by the wires coming in and the wires coming out of the diagram) are provably equal.

References

- [1] P.-L. Curien, Category theory: a programming language-oriented introduction (forthcoming).
- [2] C. Kassel, Quantum groups, Springer Verlag (1995).
- [3] S. Mac Lane, Categories for the working mathematician, Springer-Verlag(1971).