

Thermodynamique des Processus Irréversibles
Quiberon, 16-22 sept. 2018

7ème école d'été de mécanique théorique

Effets de couplage et effets dissipatifs accompagnant la déformation des matériaux solides

(3^{ème} partie)

André Chrysochoos
LMGC, UMR 5508 CNRS-UM



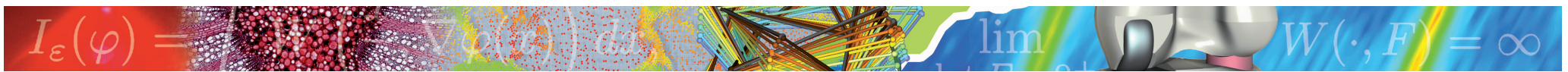

Programme

- 1 - Cadre thermomécanique et bilan d'énergie
(TPI-MSG)
- 2 - Quelques éléments rhéologiques à la sauce MSG
(d'une vision mécanique à vision thermomécanique)
- 3 - Analyse expérimentale des bilans d'énergie
(imagerie quantitative)
- 4 - Effet du temps : couplage thm et/ou viscosité ?
(interaction forte et/ou irréversibilité)
- 5 - Effet dissipatif dans les métaux
(fatigue : HCF & VHCF)

$$I_\varepsilon(\varphi) = \int \sqrt{\varphi'(t)} dt$$

lim

$$W(\cdot, F) = \infty$$

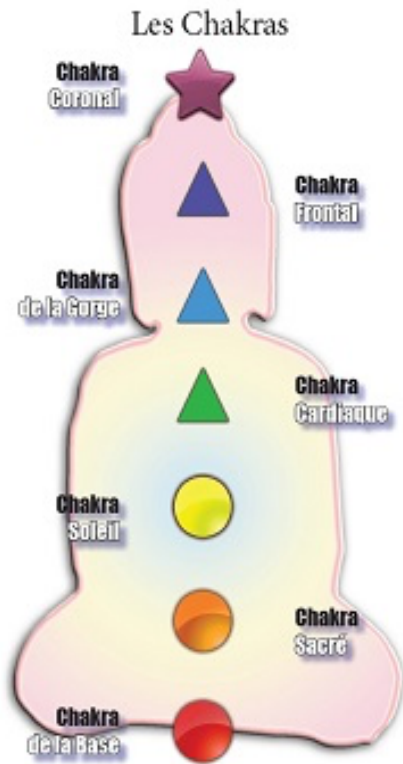

BILAN ENERGETIQUE - GRATUIT

Laissez-vous surprendre par la pertinence de ce bilan offert et découvrez comment :

- ★ *Avoir plus d'énergie !*
- ★ *Augmenter votre taux vibratoire !*
- ★ *Vivre en pleine forme !*

*Bilan d'énergie :
le retour !*



Energy balance : reminder (I)

$$\begin{aligned}
 \dot{W}_{\text{def}} &= \sigma : \dot{\varepsilon} = \sigma^r : \dot{\varepsilon} + \sigma^{\text{ir}} : \dot{\varepsilon} \\
 &= \underbrace{\sigma^r : \dot{\varepsilon} + A_\alpha \cdot \dot{\alpha}}_{\dot{W}_e + \dot{W}_s} + d_1
 \end{aligned}$$



(...)^{*} path-dependence

\dot{W}_e : rate of elastic energy

d_1 : intrinsic dissipation

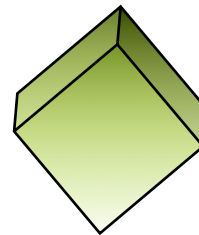

\dot{W}_s : rate of stored energy



... incomplete balance !!

Energy balance : reminder (II)

- rate of internal energy

$$\begin{aligned}
 \rho \dot{e} &= \rho C \dot{T} + \underbrace{(\sigma^r : \dot{\varepsilon} + \mathbf{A} \cdot \dot{\alpha})}_{w_e + w_s} - \underbrace{(T \sigma^r_{,T} : \dot{\varepsilon} + T \mathbf{A}_{,T} \cdot \dot{\alpha})}_{w_{thc}} \\
 &= \rho C \dot{T} + w_e + w_s - w_{thc}
 \end{aligned}$$

« thc » = thermomechanical couplings

- heat equation

$$\rho C \dot{T} + \text{div} \mathbf{q} = \underbrace{\sigma^{ir} : \dot{\varepsilon} - \mathbf{A} \cdot \dot{\alpha}}_{d_1} + T \sigma^r_{,T} : \dot{\varepsilon} + T \mathbf{A}_{,T} \cdot \dot{\alpha} + r_e$$

- comments

C.1: C specific heat

C.2: $q = -k \cdot \text{grad} T$



kinematics
required

C.3: $\dot{T} = \frac{\partial T}{\partial t} + \mathbf{v} \cdot \nabla T$

Focus on a load-unload cycle

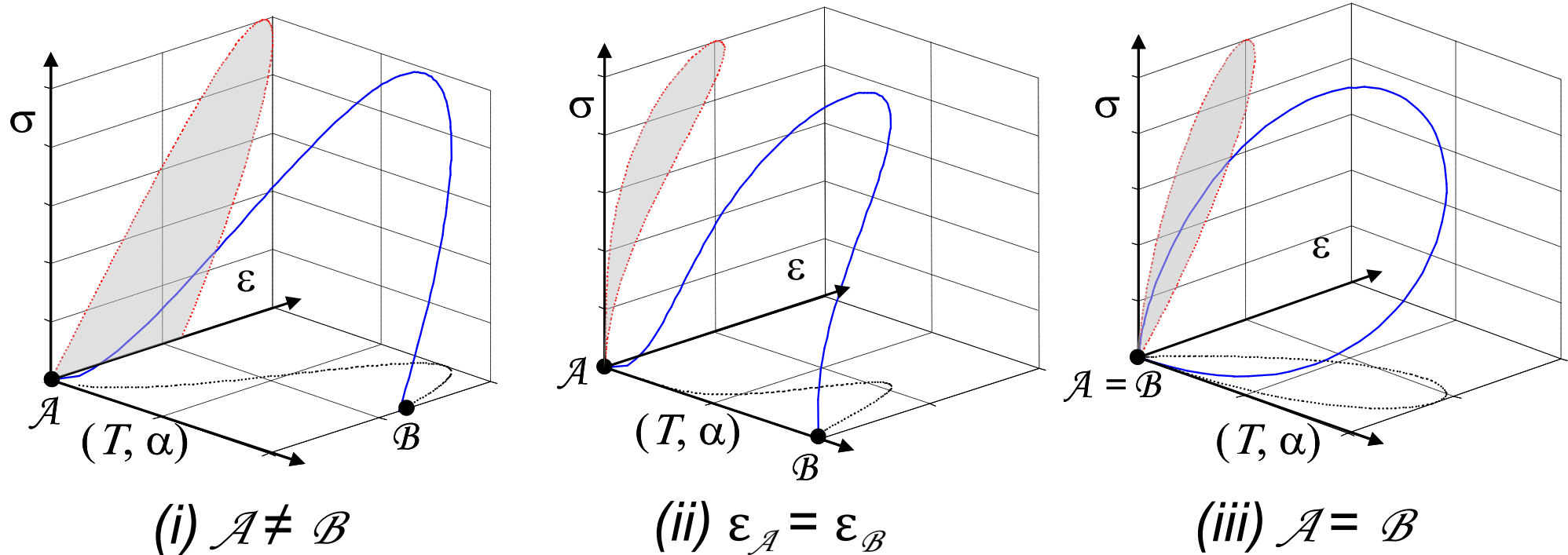

(i)
$$W_{\text{def}} = \int_{t_{\mathcal{A}}}^{t_{\mathcal{B}}} \sigma : \dot{\varepsilon} dt = \int_{t_{\mathcal{A}}}^{t_{\mathcal{B}}} d_1 dt + \int_{t_{\mathcal{A}}}^{t_{\mathcal{B}}} (\rho \dot{e} - \rho C \dot{T} + w_{\text{thc}} \dot{}) dt$$

(ii) Hysteresis loop : $W_{\text{def}} = A_h$ (for uniaxial loading)



(iii) Load-unload cycle = thermodynamic cycle

$$W_{\text{def}} = \int_{t_{\mathcal{A}}}^{t_{\mathcal{B}}} d_1 dt + \int_{t_{\mathcal{A}}}^{t_{\mathcal{B}}} w_{\text{thc}} \dot{} dt$$

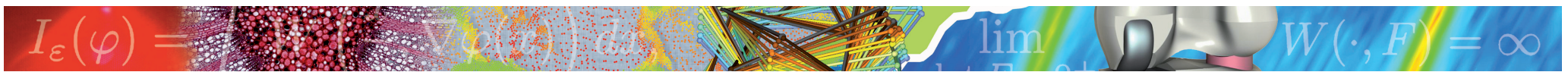

- 4 -

Effet du temps : couplage thm et/ou viscosité ?
(interaction forte et/ou irréversibilité)



Thermoélasticité standard
TSA : analyse thermique des contraintes

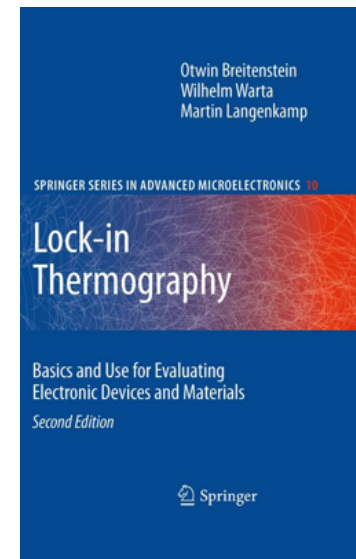

Modèle thermoélastique linéaire isotrope homogène

- ❑ mécanique : mémoire sélective
- ❑ thermodynamique : pas de dissipation intrinsèque
- ❑ variables d'état : (θ, ε) , $\theta = T - T_0$ (HPPT $\theta \ll T_0$)



Physique 1 : Superposition des déformations élastiques et thermiques

Version 1 D

$$\varepsilon = \frac{\sigma^r}{E} + \alpha_{th} \theta$$

$$\sigma^r = E(\varepsilon - \alpha_{th} \theta)$$

Version 3 D

$$\varepsilon_{ij} = \frac{1+\nu}{E} \sigma_{ij}^r - \frac{\nu}{E} \sigma_{kk}^r \delta_{ij} + \alpha_{th} \theta \delta_{ij}$$

$$\sigma_{ij}^r = \lambda \varepsilon_{kk} \delta_{ij} + 2\mu \varepsilon_{ij} - (3\lambda + 2\mu) \alpha_{th} \theta \delta_{ij}$$

Physique 2 : chaleur spécifique constante

$$C_\varepsilon = -T \frac{\partial^2 \psi}{\partial T^2} \approx -T_0 \frac{\partial^2 \psi}{\partial T^2} = C_0 \quad \Rightarrow \quad \frac{\partial^2 \psi}{\partial T^2} = -\frac{C_0}{T_0}$$

α_{th} dilatation
 C_ε chal. spé.
 $\varepsilon_{kk} = \text{tr}(\varepsilon)$
 $\varepsilon_{kk} = \frac{1}{2} \varepsilon_{ij} \varepsilon_{ij}$

□ énergie libre

$$\chi = \frac{E\alpha_{th}^2 T_0}{\rho_0 C_0}$$

1D $\rho_0 \Psi(\theta, \varepsilon) = \frac{1}{2} E(\varepsilon - \alpha_{th} \theta)^2 - \frac{\rho_0 C_0}{2T_0} (1 + \chi) \theta^2$

3D $\rho_0 \Psi(\theta, \underline{\underline{\varepsilon}}) = \frac{1}{2} (\lambda \varepsilon_I^2 + 4\mu \varepsilon_{II}) - (3\lambda + 2\mu) \alpha_{th} \theta \varepsilon_I - \frac{\rho_0 C_0 \theta^2}{2T_0}$

□ équations d'état

$$\left| \begin{aligned} \sigma_{ij}^r &= \rho \frac{\partial \Psi}{\partial \varepsilon_{ij}} = \lambda \varepsilon_I \delta_{ij} + 2\mu \varepsilon_{ij} - (3\lambda + 2\mu) \alpha_{th} \theta \delta_{ij} \\ s &= -\frac{\partial \Psi}{\partial \theta} = \frac{1}{\rho} (3\lambda + 2\mu) \alpha_{th} \varepsilon_I + \frac{\rho_0 C_0 \theta}{T_0} \end{aligned} \right.$$

□ potentiel de dissipation et équations complémentaires

$$\phi(\vec{q}, \underline{\underline{\dot{\varepsilon}}}) = \frac{k^{-1} \vec{q} \cdot \vec{q}}{2T_0}$$

k tenseur de conduction

$$\left| \begin{aligned} \underline{\underline{\sigma}}^{ir} &= \frac{\partial \phi}{\partial \underline{\underline{\dot{\varepsilon}}}} = \underline{\underline{0}} \\ \vec{q} &= -k \overrightarrow{\text{grad}} \theta \quad \text{Fourier} \end{aligned} \right.$$

□ Aspects thermiques et calorifiques

Equation générale de diffusion

$$\rho_0 C_0 \dot{T} + \text{div} \mathbf{q} = \underline{\underline{\sigma}}^{\text{ir}} : \underline{\underline{\dot{\varepsilon}}} - \mathbf{A} \cdot \dot{\alpha} + T \underline{\underline{\sigma}}_{,T}^{\text{r}} : \underline{\underline{\dot{\varepsilon}}} + T \mathbf{A}_{,T} \cdot \dot{\alpha} + r_e$$

Matériau thermoélastique isotrope homogène

$$\rho_0 C_0 \dot{T} - k \Delta T = \underline{\underline{\sigma}}^{\text{ir}} : \underline{\underline{\dot{\varepsilon}}} - \mathbf{A} \cdot \dot{\alpha} + T \underline{\underline{\sigma}}_{,T}^{\text{r}} : \underline{\underline{\dot{\varepsilon}}} + T \mathbf{A}_{,T} \cdot \dot{\alpha} + r_e$$

Source thermoélastique

$$s_{\text{the}} = T \underline{\underline{\sigma}}_{,T}^{\text{r}} : \underline{\underline{\dot{\varepsilon}}} = T \frac{\partial^2 \psi}{\partial T \partial \varepsilon_{ij}} \dot{\varepsilon}_{ij} = -(3\lambda + 2\mu) T \alpha_{\text{th}} \text{tr}(\dot{\varepsilon}_{ij}) = -3KT \alpha_{\text{th}} \dot{\varepsilon}_I$$

Modèle simple (i.e. différentiel) de diffusion [AC, Photomécanique, 95]

$\theta = T - T_0$ (HPPT $\theta \ll T_0$), sources homogènes, fuites linéaires, ...

la solution spectrale limitée au 1^{er} vecteur propre...



$A_i = \partial \psi / \partial \alpha_i$
 Variables internes

$$\dot{\theta} + \frac{\theta}{\tau_{\text{th}}} = - \frac{3KT \alpha_{\text{th}}}{\rho_0 C_0} \dot{\varepsilon}_I$$

□ Application à l'analyse thermique des contraintes (TSA)

P. Stanley & J. Barton (UK), J. Rowlands (AUS), U. Galietti (IT), ...
 Dispositif SPATE (79), Deltatherm (96) ...

$$s_{the} = -3KT\alpha_{th}\dot{\varepsilon}_I = -T\alpha_{th}\dot{\sigma}_I - 9K\alpha_{th}^2\dot{\theta}$$

$$\left(1 + \underbrace{\frac{9K\alpha_{th}^2T_0}{\rho_0C_0}}_{\ll 1}\right)\dot{\theta} - \underbrace{\frac{k}{\rho_0C_0}}_{\text{diffusivité}}\Delta\theta = -\frac{\alpha_{th}T}{\rho_0C_0}\dot{\sigma}_I$$

Si processus adiabatique et faibles variations de température ...

$$\delta\theta = -\frac{T_0\alpha_{th}}{\rho_0C_0}\delta\sigma_I = K_{TSA}\delta\sigma_I$$

« Vous mesurez des températures, vous mesurez des contraintes ! »

TSA : un exemple d'application industrielle

New developments in Thermo Elastic Stress Analysis by Infrared Thermography.

P. Bremond – Cedip IR systems

IV Conferencia Panamericana de END Buenos Aires – 2007

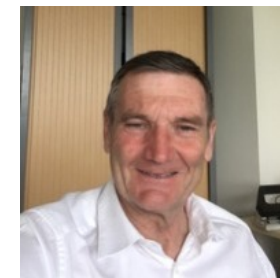

Pierre Bremond
Agema – Additional
Cedip – Flir

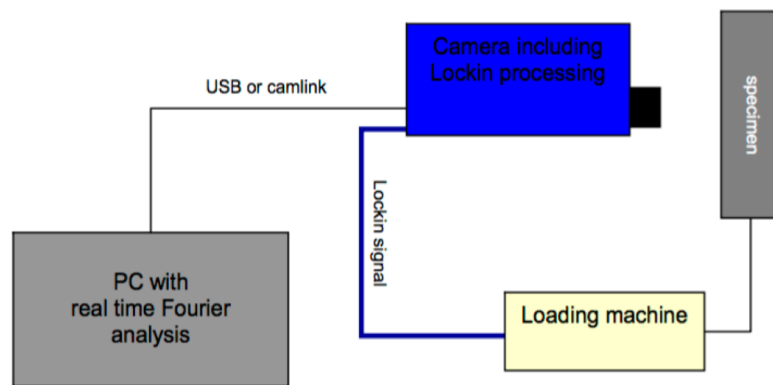

Figure 1. Signal processing into Thermoelastic Stress Analyzer



R. Williams

SFT
GDR 2519
PM
SEM

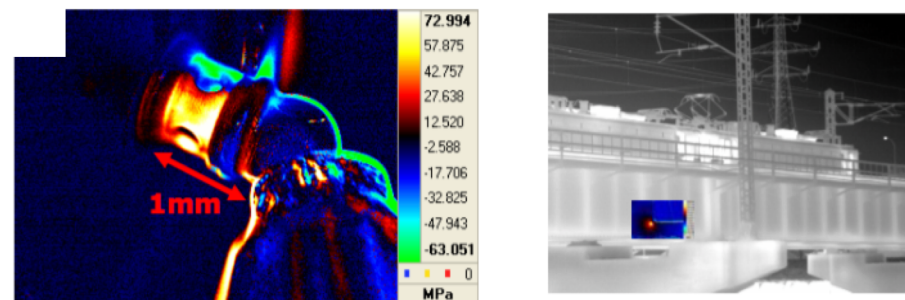

Figure 4. Size of object analyzed by TheSA

TheSA systems have a large panel of applications. Basically the use of imaging measurement systems is required when localization of high stress is unknown or to compare to another full field data like FEA results.

TSA : bilan qualitatif

Points forts :

- Méthode « simple » à mettre en œuvre
- Champ du premier invariant du tenseur des contraintes
- Contraintes planes :
TSA + Photoélasticimétrie → contraintes principales
Cf. [Barone, Wang, Patterson, IUTAM 1998]
- Concentration de contraintes sur structures planes, biréfringentes

Limitations :

- Mesure de θ : pièces massives complexes, corps lambertiens,
- Diffusion, rayonnement parasites... stabilité thermique...
- Adiabaticité
- Comportement élastique ... caractéristiques homogènes, constantes ...

$$\delta\theta = -\frac{T_0 \alpha_{th}}{\rho_0 C_0} \delta\sigma_I$$



Elasticité caoutchoutique
Inversion thermoélastique



Rubber elasticity [Caborgan et al., 2009]

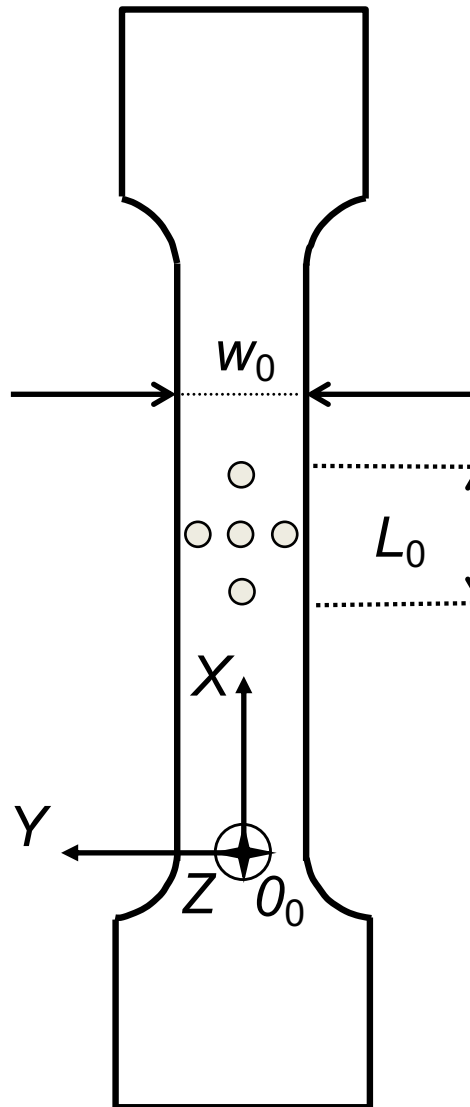

Specimen and material

gauge part

$L_0 = 5 \text{ mm}$
 $w_0 = 6 \text{ mm}$
 $t_0 = 2.1 \text{ mm}$

Specimen: thin, flat
dog-bone shaped

« *natural* » rubber (NR)

cis-1,4 polyisoprene,
 per 100 g 3 g stearic acid,
 9.85 g zinc oxide,
 2 g antioxidant,
 3 g sulphur,
 3 g plasticiser,
 4 g accelerators

heated at 160 °C for 10 minutes,
 stored at - 10 °C, in dry air

Rubber elasticity: molecular approach (I)

Molecular chain

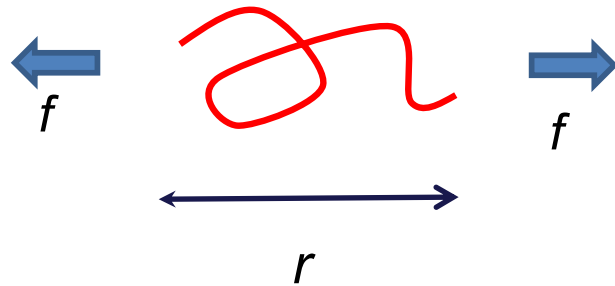

$$f = \frac{3kT}{\langle r_0^2 \rangle} r$$

Entropic elasticity

$$f = \left(\frac{\partial \Psi}{\partial r} \right)_T = \cancel{\left(\frac{\partial E}{\partial r} \right)_T} - T \left(\frac{\partial S}{\partial r} \right)_T$$

$$S = k \log(\Omega)$$

Ω : number of conformations

k : Boltzmann constant

$\langle r_0^2 \rangle$ m. s. end-to-end distance of the chain

- f vs. r : linear \Rightarrow « elasticity »
- f vs. T : $f \nearrow$ with T !! \Rightarrow different from standard thermoelasticity where $f \searrow$ with T + volume variation (i.e. thermodilatibility) !!

Rubber elasticity: molecular approach (II)

Chain \rightarrow Network (N_{ch} chains)

Statistical modeling of molecular network

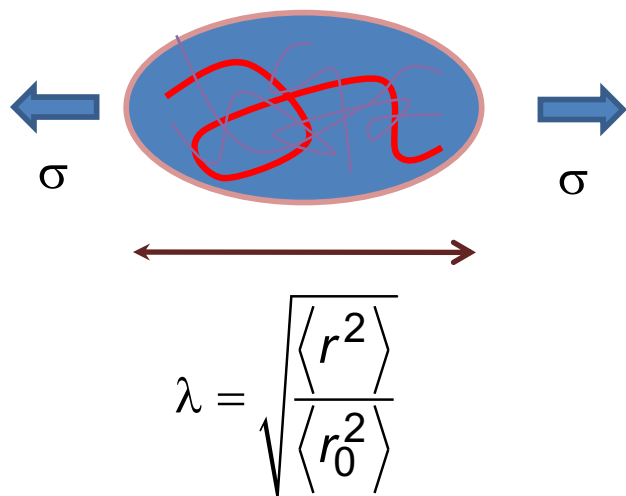

- affine model [Flory, 1953]

- isotropic material

$$\Delta\psi_{nwk} = -T\Delta S_{nwk} = \frac{N_{ch}kT}{2}(I_1 - 3)$$

$$I_1^2 = \text{tr}(F^T F) = \sum_{i=1}^3 \lambda_i^2$$

$$F = \frac{\partial \mathbf{x}}{\partial \mathbf{X}} \quad \text{transformation gradient tensor}$$

λ_i extension ratios

- incompressibility assumption
- uniaxial loading in the direction 1

tensile Cauchy stress

$$\sigma_{11} = N_{ch}kT(\lambda_1^2 - \lambda_1^{-1}) = N_{ch}kT(e^{2\varepsilon_{11}} - e^{-\varepsilon_{11}})$$

with ε the Hencky strain tensor

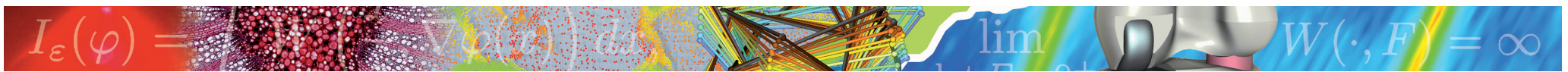

Rubber elasticity: mechanical approach (III)

Hyperelasticity : continuum thermomechanical approach

- non linear elasticity at finite strain
- objectivity (strain invariants)
- initial isotropy
- isochoric transformation
- often isothermal models

A lot of « phenomenological » models, e.g. Mooney-Rivlin [1948], [Ogden, ...]

$$\boxed{\psi(\lambda_i) = C_1(I_1 - 3) + C_2(I_2 - 3)} \xrightarrow{\text{tension}} \boxed{\sigma_{11} = 2(\lambda_1^2 - \lambda_1^{-1})(C_1 + C_2\lambda_1^{-1})}$$

$$\text{with } I_1 = \lambda_1^2 + \lambda_2^2 + \lambda_3^2 \quad I_2 = \lambda_1^2\lambda_2^2 + \lambda_2^2\lambda_3^2 + \lambda_3^2\lambda_1^2 \quad I_3 = \lambda_1^2\lambda_2^2\lambda_3^2 = 1$$

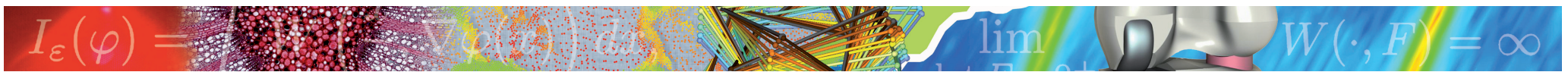

Rubber elasticity: modified entropic elasticity (III)

(i) Entropic effects : Gough [1805] - Joule [1857]

$$e(s, \varepsilon) = e_c(T) \quad \text{analogy of perfect gaz} \quad \psi_c(T, \varepsilon) = TK_1(\varepsilon) + K_2(T)$$

(ii) Inversion of thermoelastic effect : Anthony [1942]

standard thermoelasticity at low extension ratio, rubber effects at high strain ratio

(i), (ii) literature: modified entropic elasticity

$$e(s, \varepsilon) = e_1(T) + e_2(\varepsilon) \quad [\text{Chadwick and Creasy, 1984}]$$

drawback : strongly non linear expression,
many parameters hardly identifiable

Rubber behavior: a simple heuristic model (IV)

Proposal:

- « leave » the classical framework of (entropic) elasticity
- interpret the « thermoelastic inversion » as a competition between 2 coupling mechanisms
- describe this competition introducing a « rubber strain tensor » ε_c in a series model

$$\psi(T, \varepsilon, \varepsilon_c) = \psi_{\text{the}}(T, \varepsilon - \varepsilon_c) + \psi_c(T, \varepsilon_c)$$

standard thermoelastic free energy

free energy of affine model



a first step ... towards possible irreversibility ; Mullins effects [Mullins, 1948]

$$\varphi(q, \dot{\varepsilon}, \dot{\varepsilon}_c; T) = \frac{q^2}{2kT} + \eta \dot{\varepsilon}_c^2$$



Thermoelastic inversion : protocol

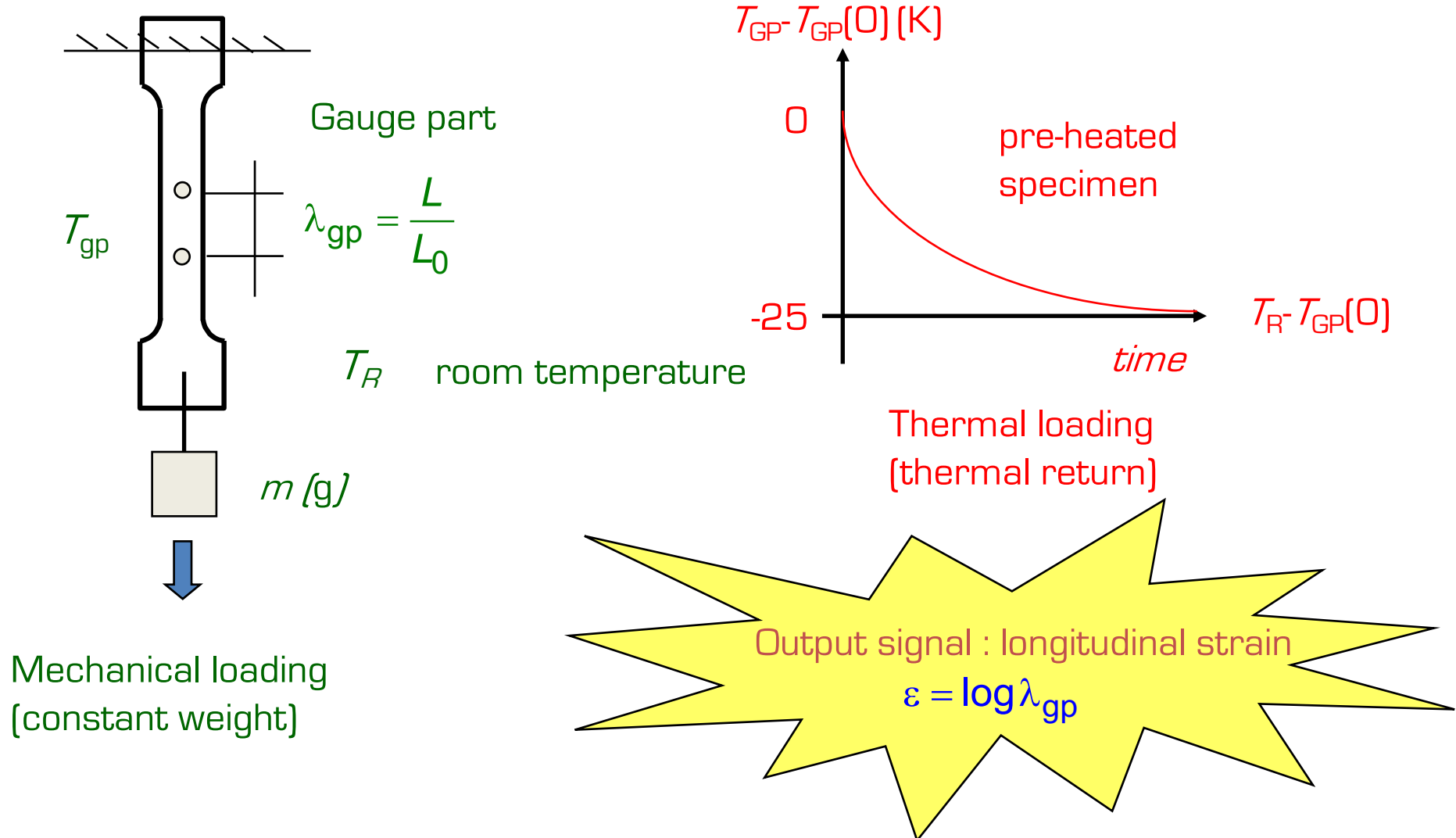

Thermoelastic inversion : results

Anthony , 1942: relaxation test



PHD Caborgan 2010 : creep test

No viscosity here !?

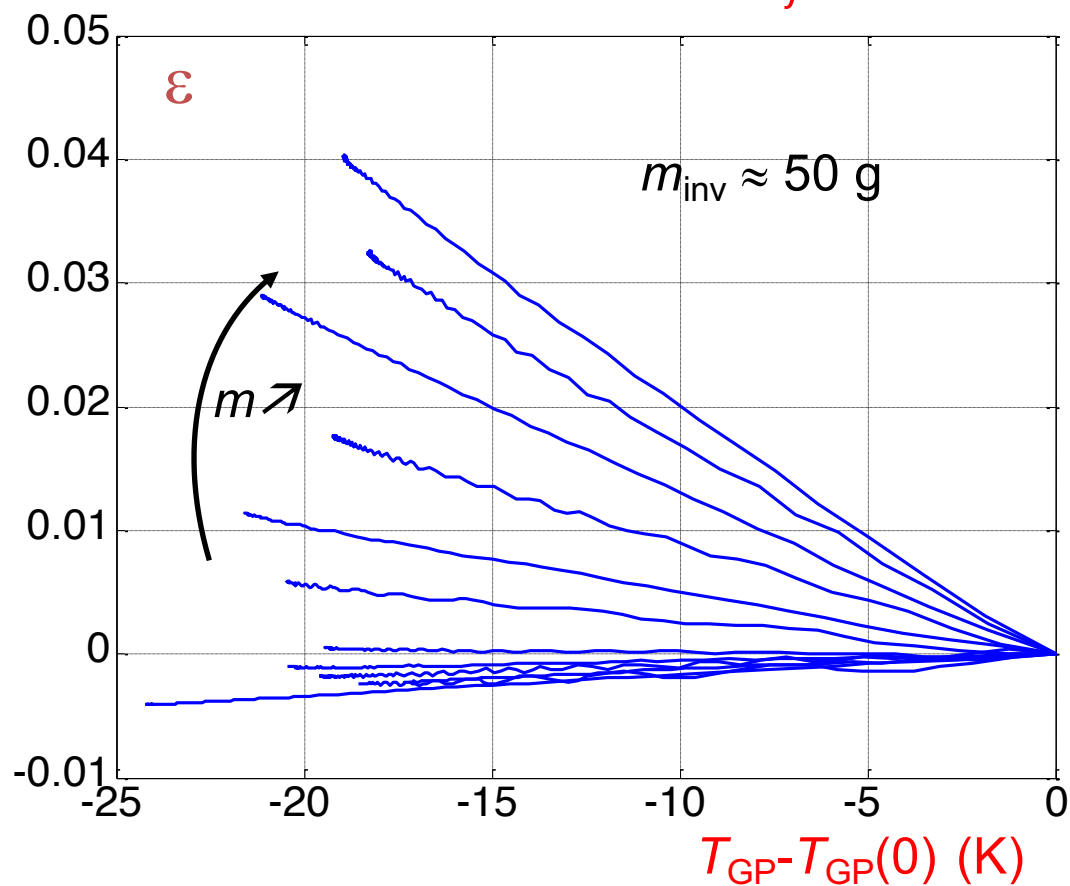

$$\varepsilon \leq 0 \text{ if } m \leq m_{inv}$$

Predominance of thermoelastic coupling

$$\varepsilon > 0 \text{ if } m > m_{inv}$$

Predominance of rubber coupling

$m = 0$ 3 30 40 **50** 60 100 200 300 400 520 640 730

Load-unload cycles : experimental results

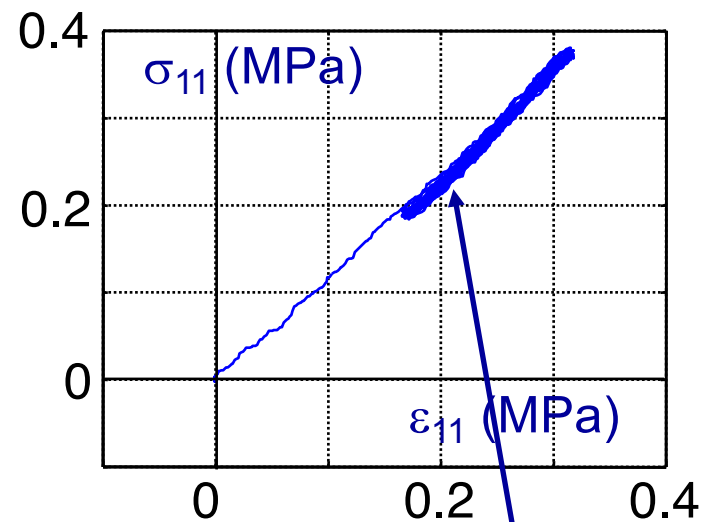
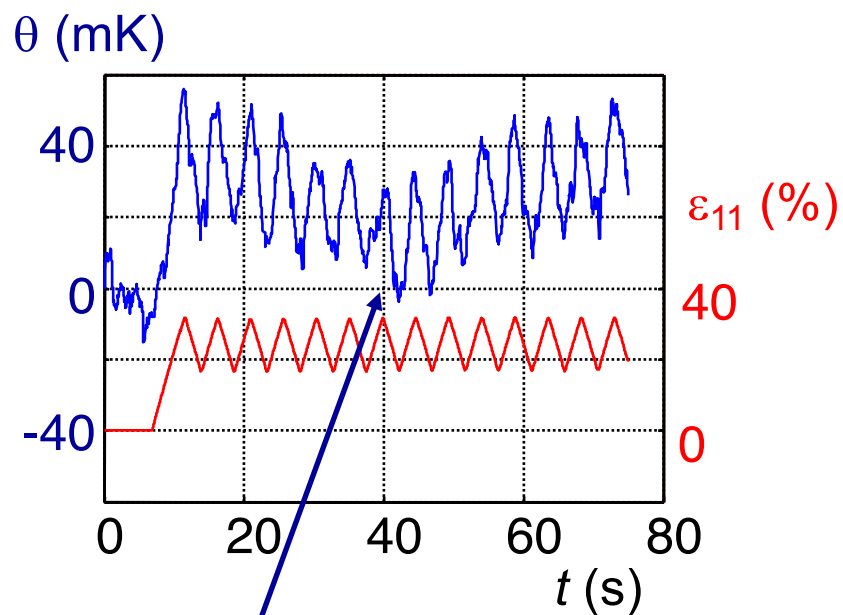

« Quasi-elastic »
response

Oscillation
Drift (± 10 mK)

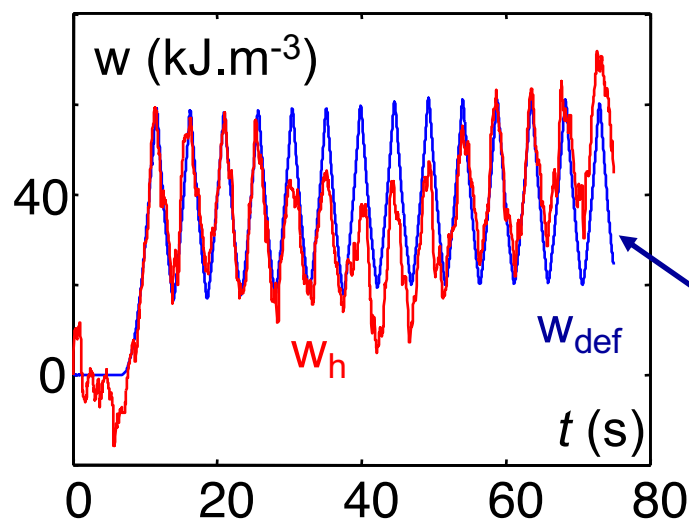

$w_{\text{def}} \approx w_h$
 $e \approx e_c(T)$

Euristic 1D model: identification

volume free energy

$$\psi(\theta, \varepsilon, \varepsilon_c) = \underbrace{\frac{E}{2} (\varepsilon - \varepsilon_c - \alpha_{th} \theta)^2}_{\psi_{the}} - \underbrace{\left(\frac{\rho C}{T_0} + E \alpha_{th}^2 \right) \frac{\theta^2}{2} + K_c (T_0 + \theta) \left(\frac{e^{2\varepsilon_c}}{2} + e^{-\varepsilon_c} - \frac{3}{2} \right)}_{\psi_c}$$

dissipation potential

$$\varphi(q, \varepsilon, \varepsilon_c) = \frac{q^2}{2kT_0} + \eta \dot{\varepsilon}_c^2$$

material constants

$$\rho = 950 \text{ kg.m}^{-3}, C = 1150 \text{ J.kg}^{-1}.\text{K}^{-1}, \tau_{eq} = 20 \text{ s (0D diffusion model)}$$

$$E = 100 \text{ MPa}, \alpha_{th} = 2.10^{-4} \text{ K}^{-1}$$

$$K_c = 1110 \text{ Pa.K}^{-1}$$

$$\eta = 0 \text{ MPa.s, no viscous effect...}$$

Thermoelastic inversion : exp. vs. num. responses

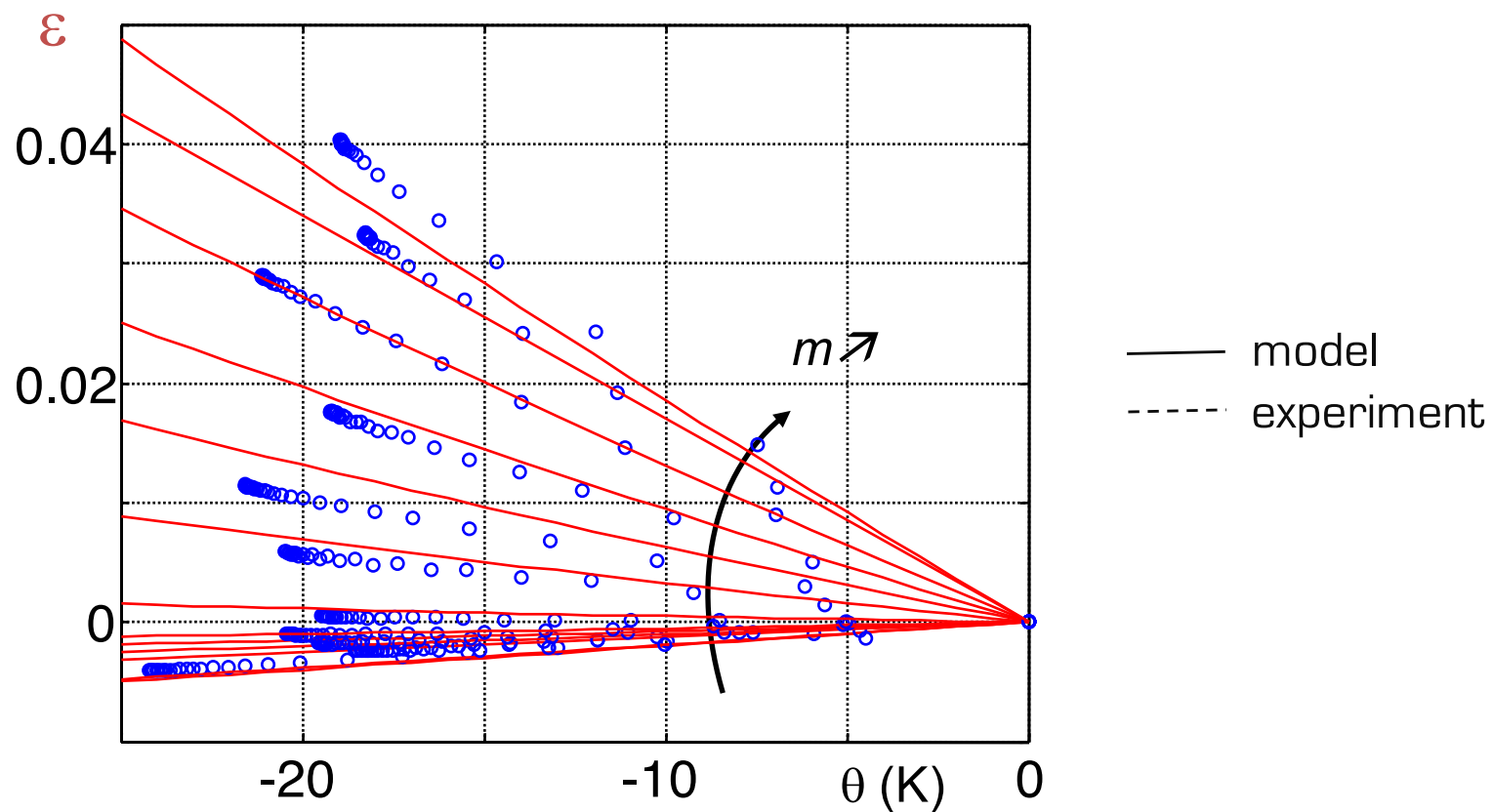

$m = 0 \quad 3 \quad 30 \quad 40 \quad 50 \quad 60 \quad 100 \quad 200 \quad 300 \quad 400 \quad 520 \quad 640 \quad 730$

Load-unload cycles : exp. vs. num. responses

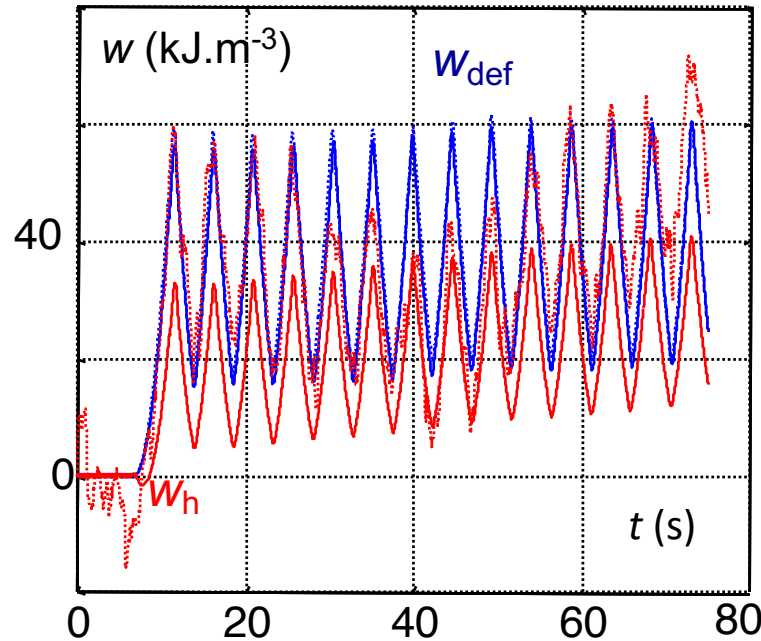
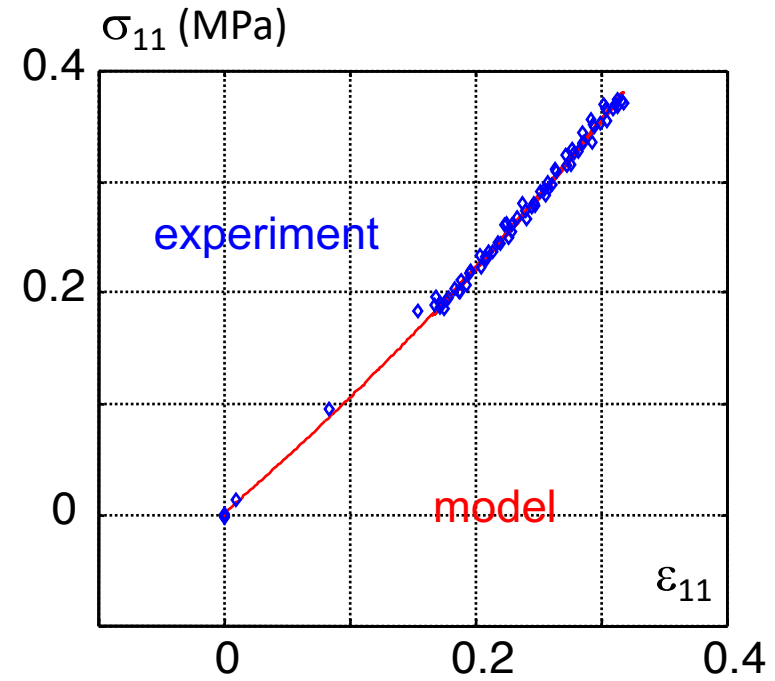
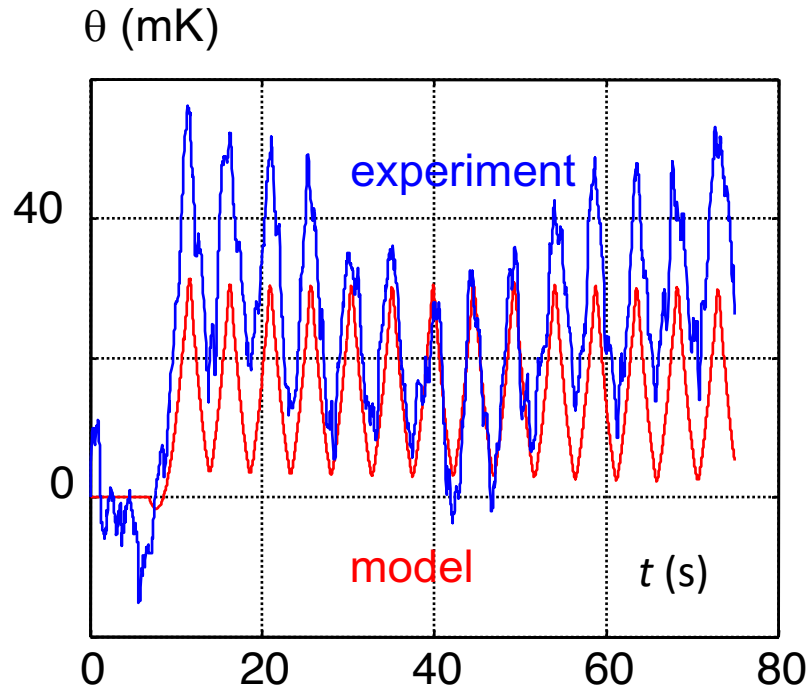

— model
 - - - experiment

$\varepsilon_{\max} = 0,4$

Load- unload test (large strain)

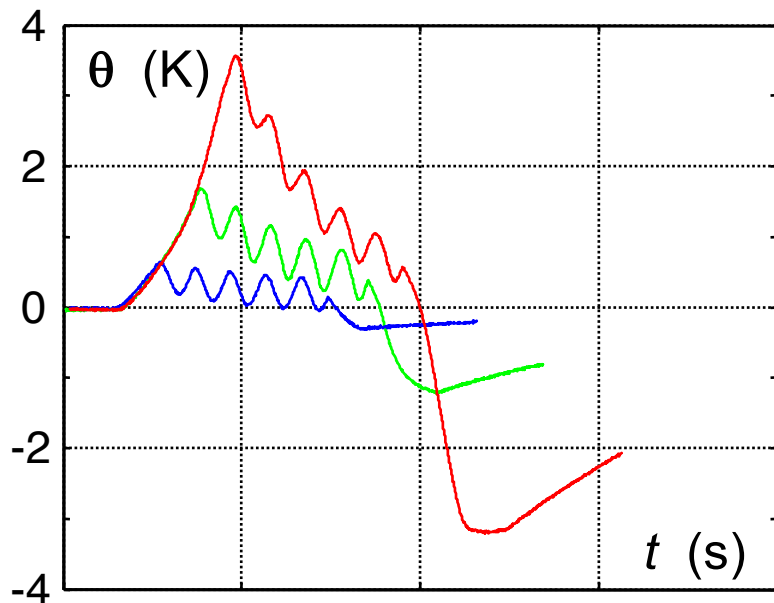
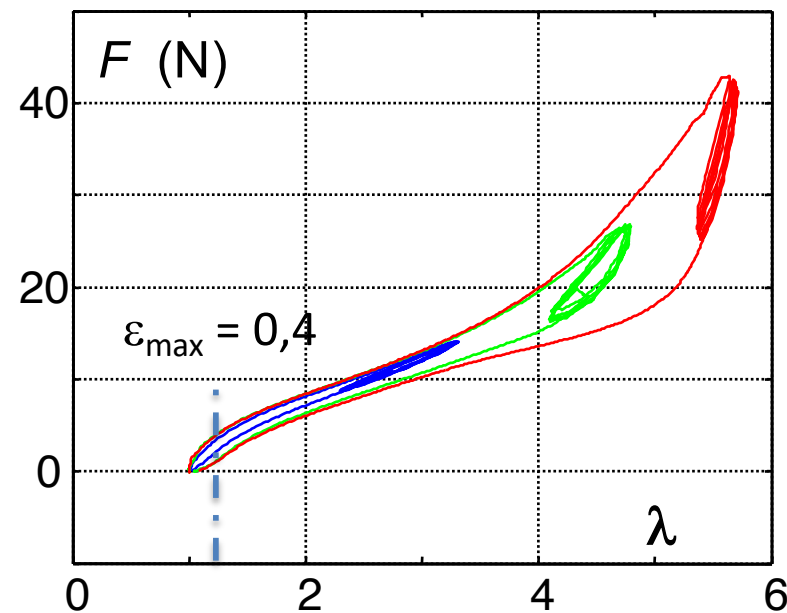
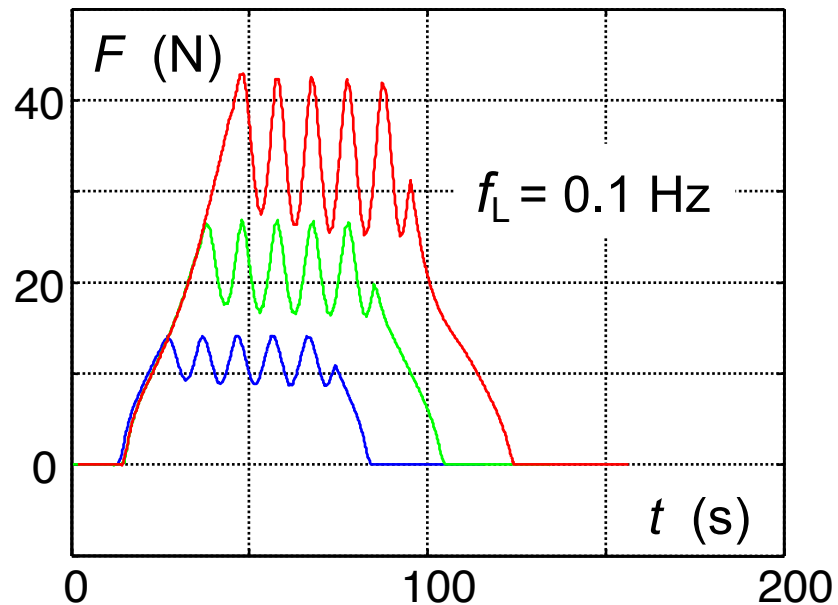

- 3 tests , 5 « internal » loops
- displacement controlled tests
- hysteresis loops
- thm couplings vs. dissipation

Energy balance at large strain

[Caborgan, PhD 11]

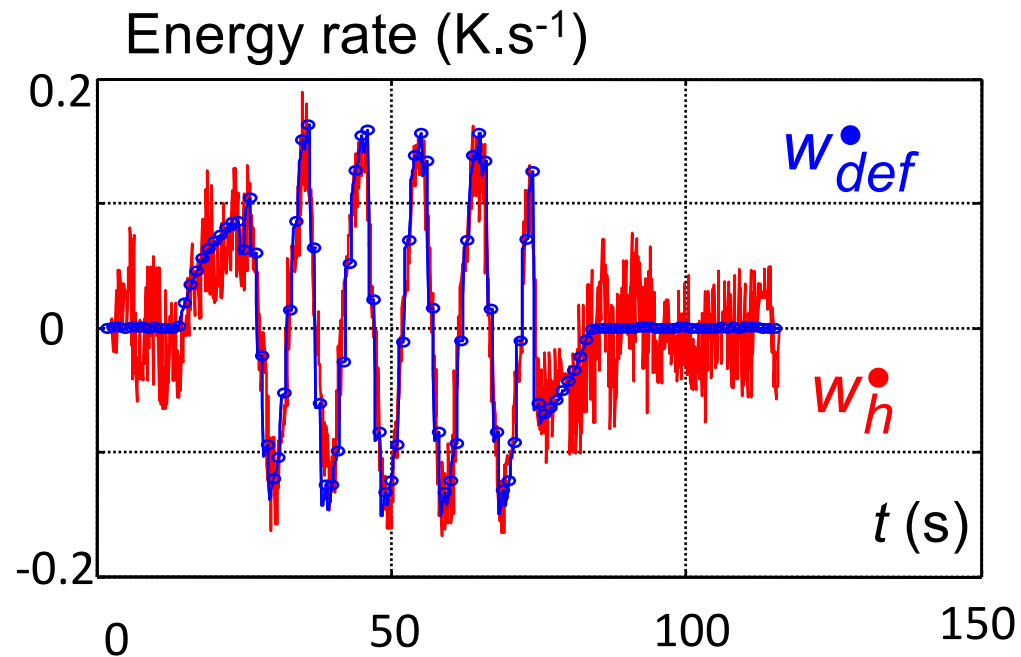
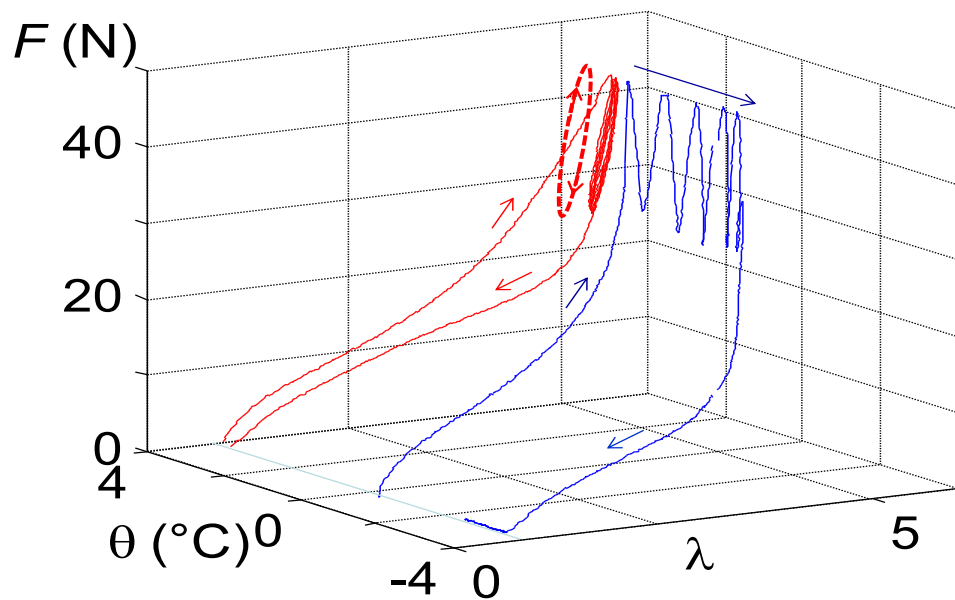

In agreement with the « perfect gaz » hypothesis

$$w_{def} = w_h$$

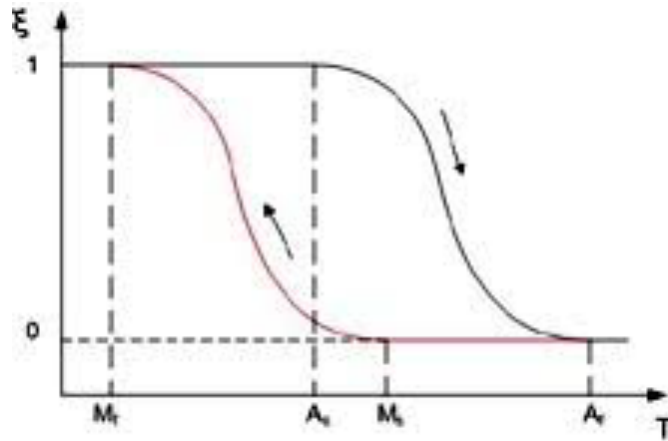

Transition de phase solide-solide
 Pseudoélasticité des AMF

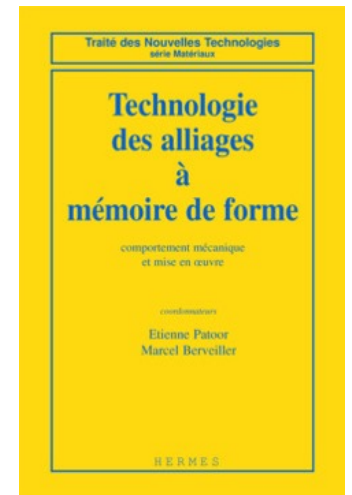
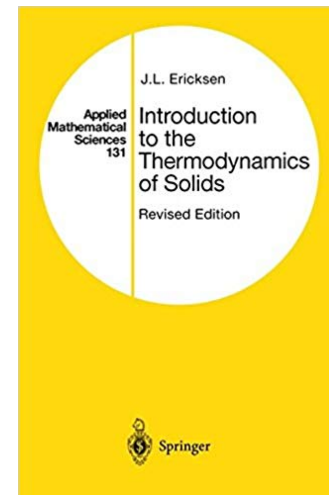

Pseudoélasticité des AMF : un «vieux» exemple

M. Löbel [95] → X. Balandraud [00] → S. Leclercq [01]

Monocristaux d'AMF CuZnAl CuAlBe

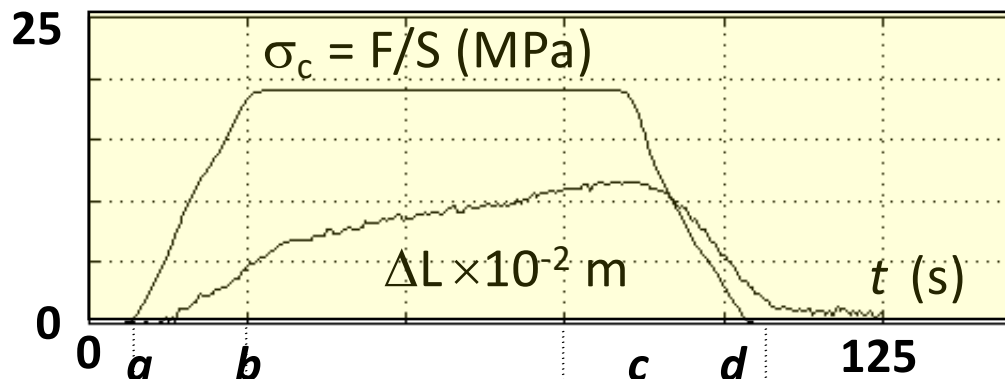

- fluage de l'éprouvette

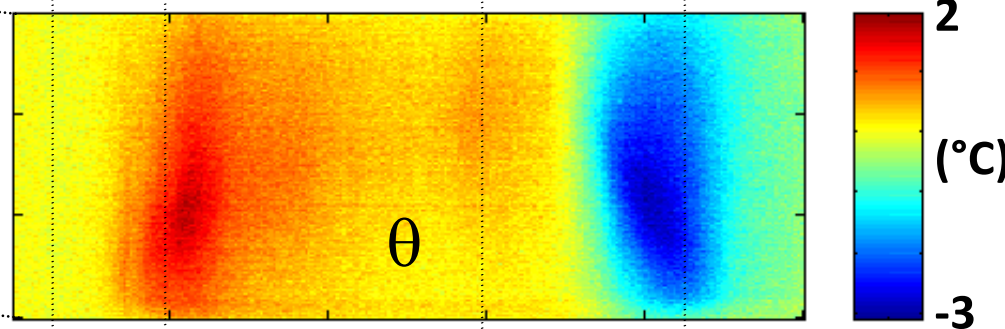
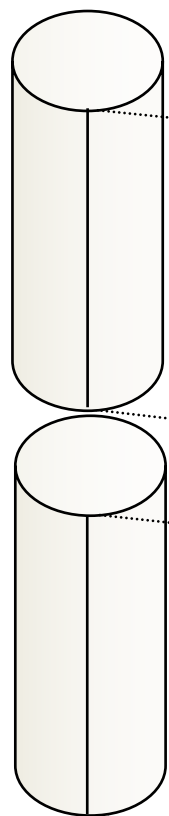

- diffusion

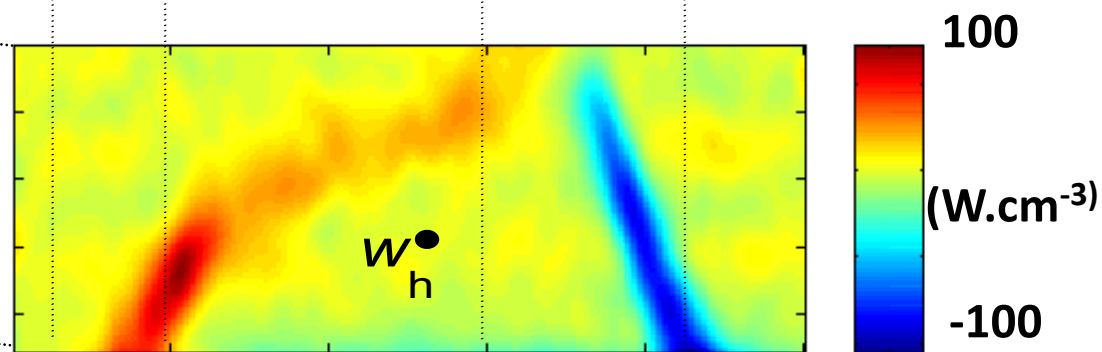

- propagation d'un front

Energy balance for “pseudoelastic” SMA

Load-unload cycle

$$\mathcal{A}_{fi} \approx 1,9 \text{ MJ.m}^{-3}$$

$$w_{\text{def}} \Big|_{\mathcal{A}}^{\mathcal{C}} = 4,9 \text{ MJ.m}^{-3}$$

$$w_h \Big|_{\mathcal{A}}^{\mathcal{C}} = 28 \text{ MJ.m}^{-3}$$

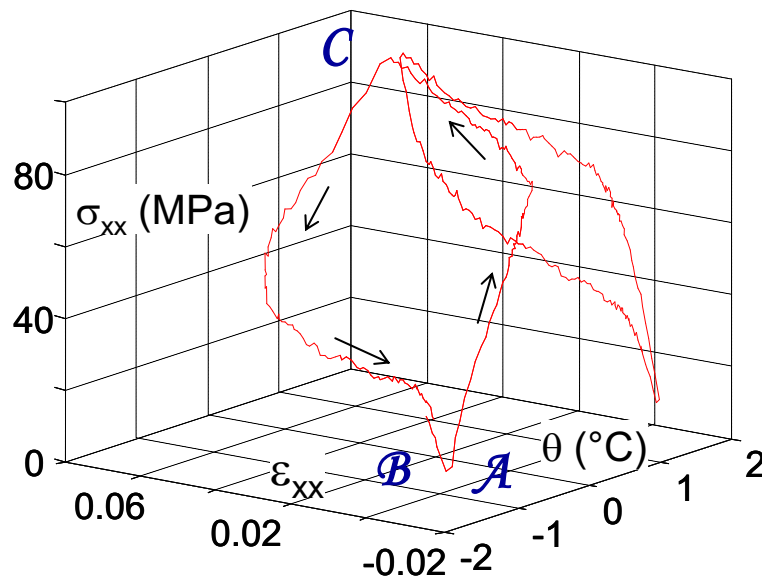
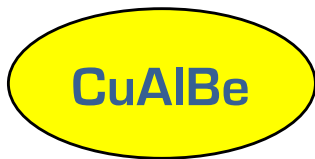

specimen response (macroscale)

[S. Vigneron, PhD 09]

$$R_M = \frac{\mathcal{A}_{fi}}{w_{\text{def}}} \approx 0,39$$

$$0 \leq R_T = \frac{\int w_h d\tau}{\int |w_h| d\tau} \approx 0,026 \leq 1$$

$R_T = 0$ non dissipative (intrinsically) + isothermal or adiabatic process
 $R_T = 1$ purely dissipative (intrinsically) process without any coupling effect

strong thermomechanical couplings

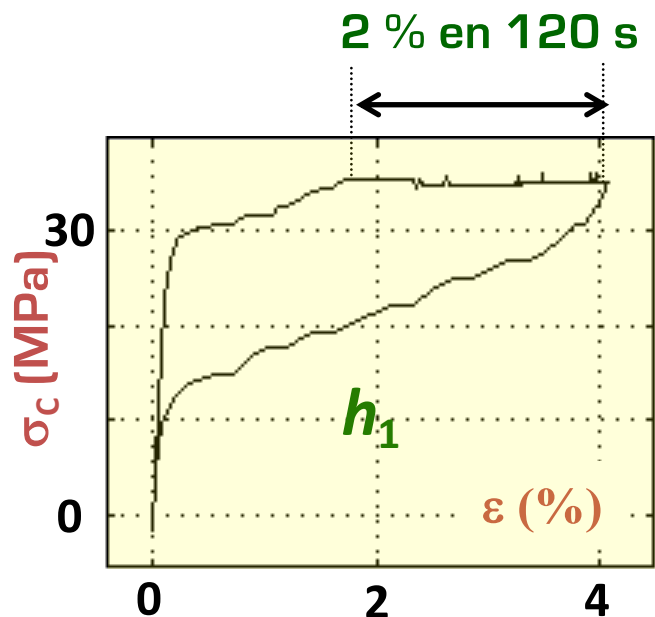

Convection naturelle

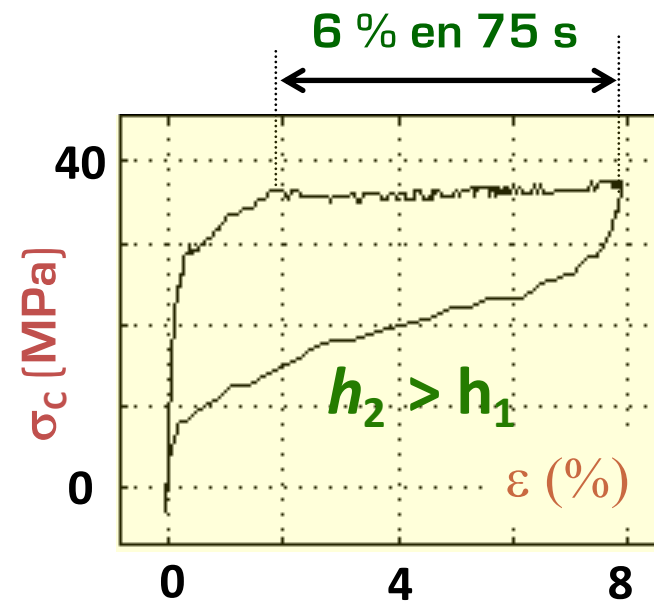
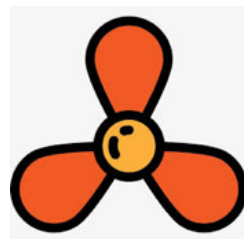

Convection faiblement turbulente

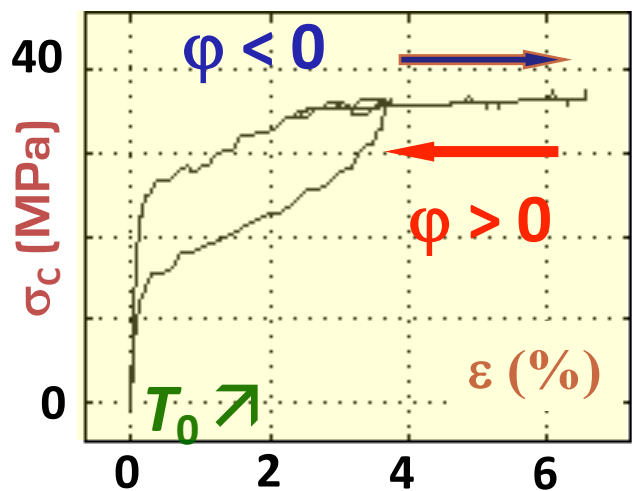

Inversion du flux



Vitesse de fluage : CL thermiques
 Fluage «inverse»
 Hystérésis [$R_T < 5\%$]
 Comportement ThM couplé :

**Transformation de phase
 anisotherme sous contrainte**

Heterogeneous mesoscopic responses

CuAlBe

meso

Localization of phase change
Propagation of phase change front

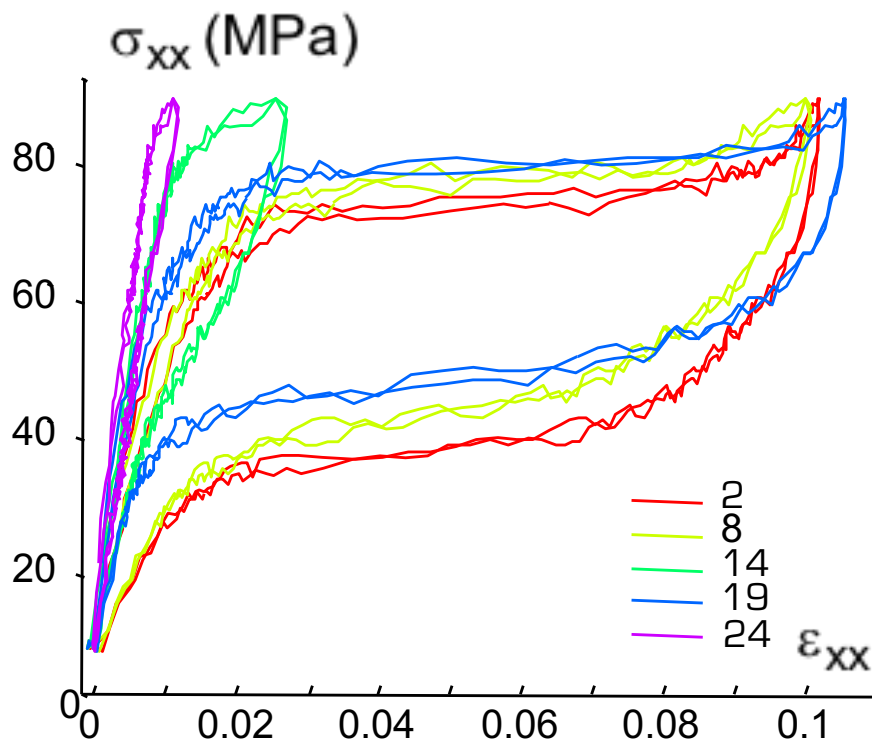

stress-strain diagram

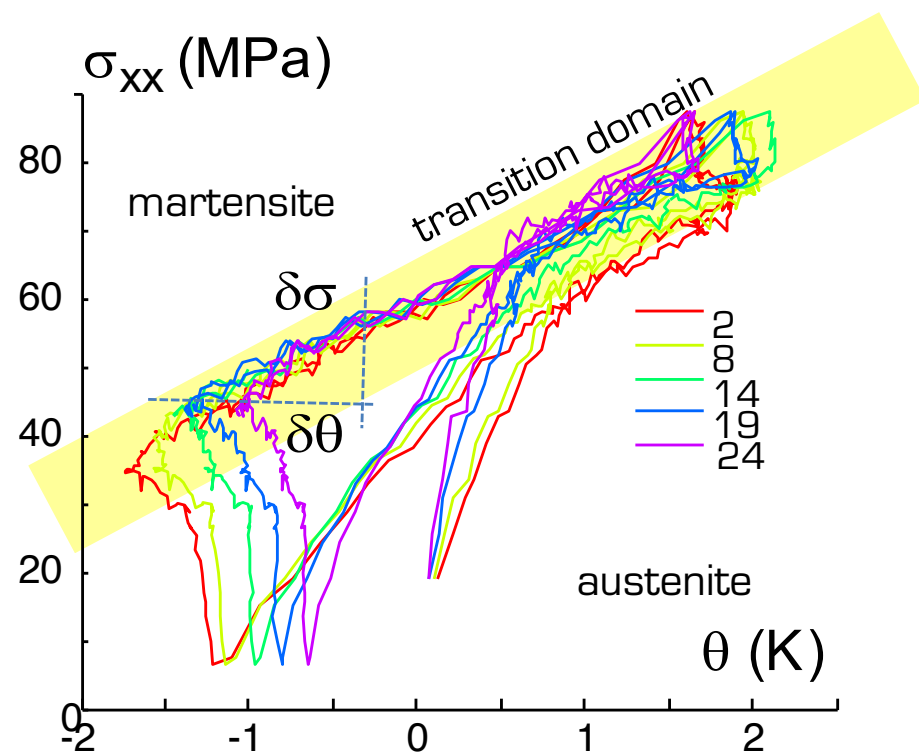

phase diagram

$\delta\theta$ transition domain «thickness» $\sim 1\text{K}$ (15 K for the SMA producer !)

Modélisation : 1^{ers} ingrédients

- Petites perturbations thm $\theta = T - T_0$ T_0
- Cinématique $\varepsilon = \varepsilon_e + \varepsilon_\theta + \varepsilon_X$ $\varepsilon_X(X) = \sum_n X_n \beta_n$
- Énergie libre $\psi(T, \varepsilon, X) = \psi_{\text{the}}(T, \varepsilon - \varepsilon_X(X)) + \psi_{\text{tr}}(T, X)$
- Potentiel de dissipation $\varphi(\nabla T, \dot{\varepsilon}, \dot{X}) \Rightarrow \varphi(\nabla T)$ $\left\{ \begin{array}{l} \sigma^{\text{ir}} = 0 \\ Z = 0 \\ \text{si } \dot{X} \neq 0 \end{array} \right.$
- Bilan d'énergie

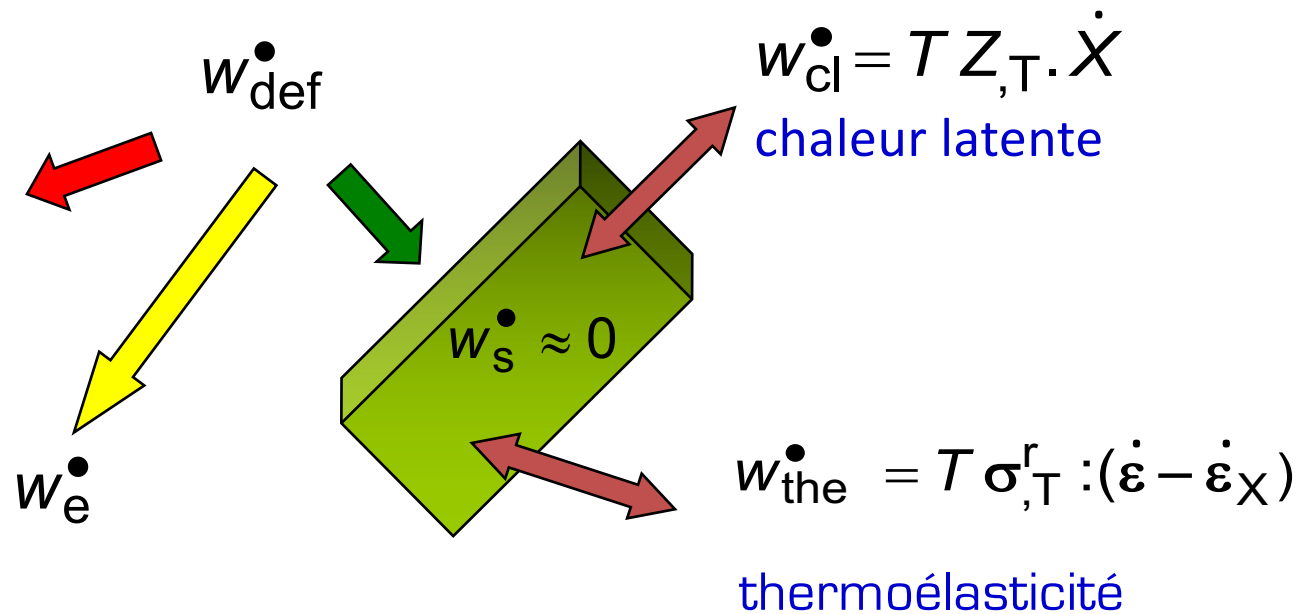

$Z = f(T, \varepsilon, X) = 0$
cinétique +
diagramme
de phase

Modèle ThM-1D

- traction

$$\sigma \geq 0$$

- quasi-staticité

$$\sigma_{,X} = 0$$

- cinématique

$$\varepsilon = \frac{\sigma}{E} + \alpha\theta + \beta X$$

- cinétique (austénite-martensite)

$$Z \dot{X} = 0$$

force nulle si
transformation de phase

Constantes

E : Module d'Young

α : dilatation

β : transformation

k : conduction

ρ : masse volumique

C : chaleur spécifique

$$\begin{cases} n_\alpha + n_\beta = 1 \\ \mu_\alpha = \mu_\beta \\ 0 \leq X = n_\alpha - n_\beta \leq 1 \\ Z = \mu_\alpha - \mu_\beta \end{cases}$$



Modèle ThM-1D

- diagramme de phase

«Martensite» : G.B. Olson & W.S. Owen
 Chap. 12, 1991.



- Cinématique [algébrique !]

$$X = \min \left(1, \left\langle \frac{\sigma - K(T - A)}{K(A - M)} \right\rangle^+ \right)$$

- existence d'un front

$$A - M \ll A \quad A - M \approx 10^{-3} \text{ } ^\circ\text{C}$$

*i.e. localisation des déformations
 et des sources de chaleur*

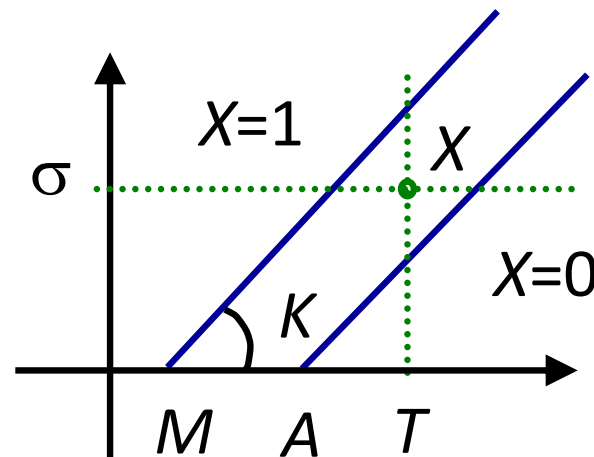
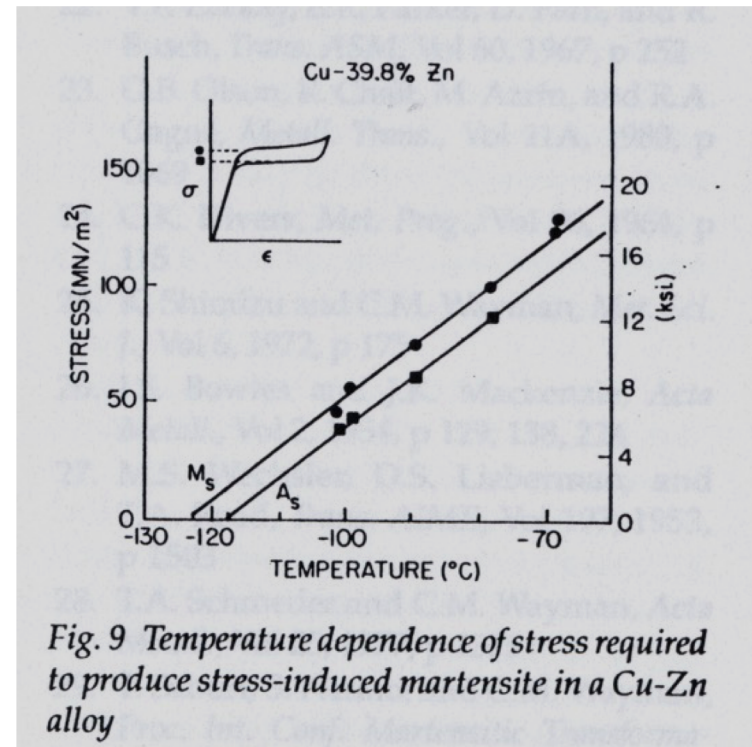

Essai numérique (I)

Coefficient d'échange et vitesse du front

$h_1 = 10 \text{ W/m}^2\text{K}$
 convection naturelle

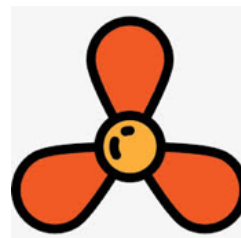

$h_2 = 60 \text{ W/m}^2\text{K}$
 légère turbulence

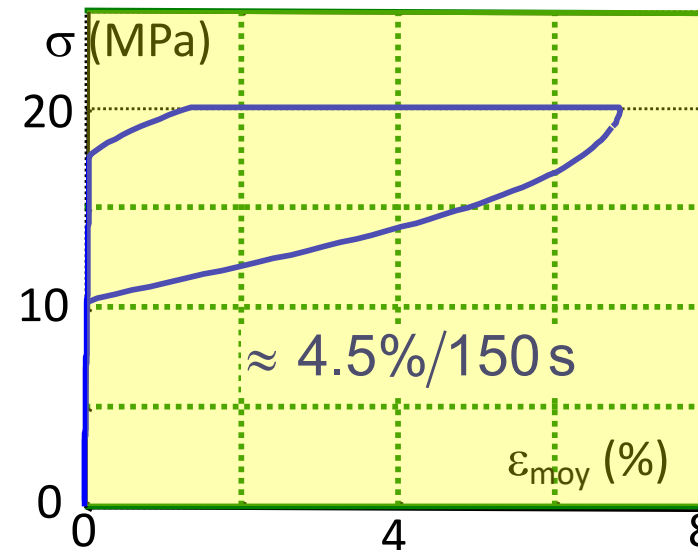
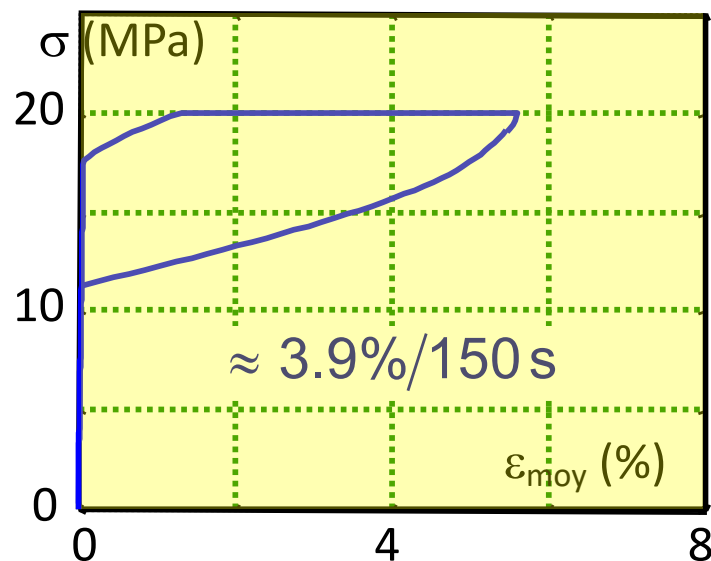

fluage + hystérésis ... sans viscosité

Essai numérique (II)

Fluage et fluage « inverse »

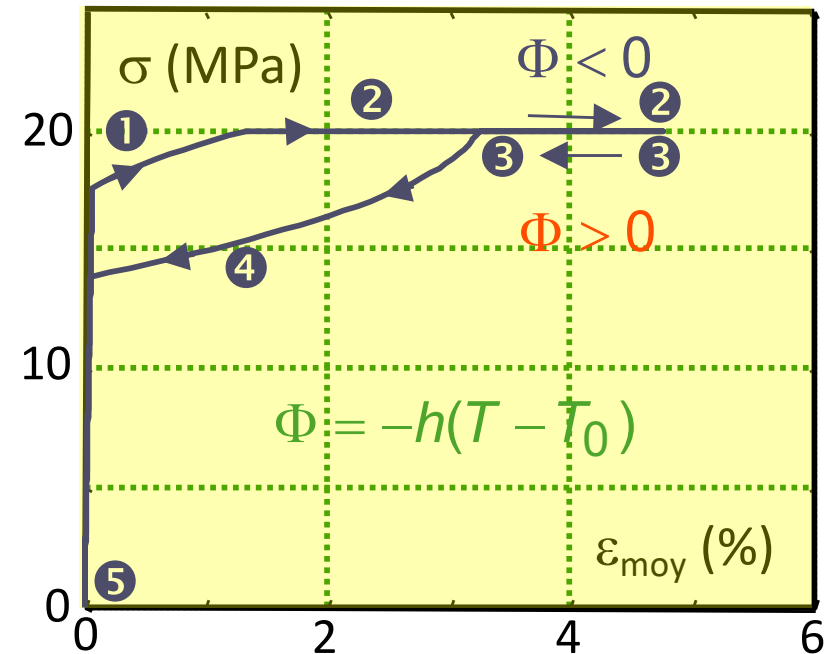
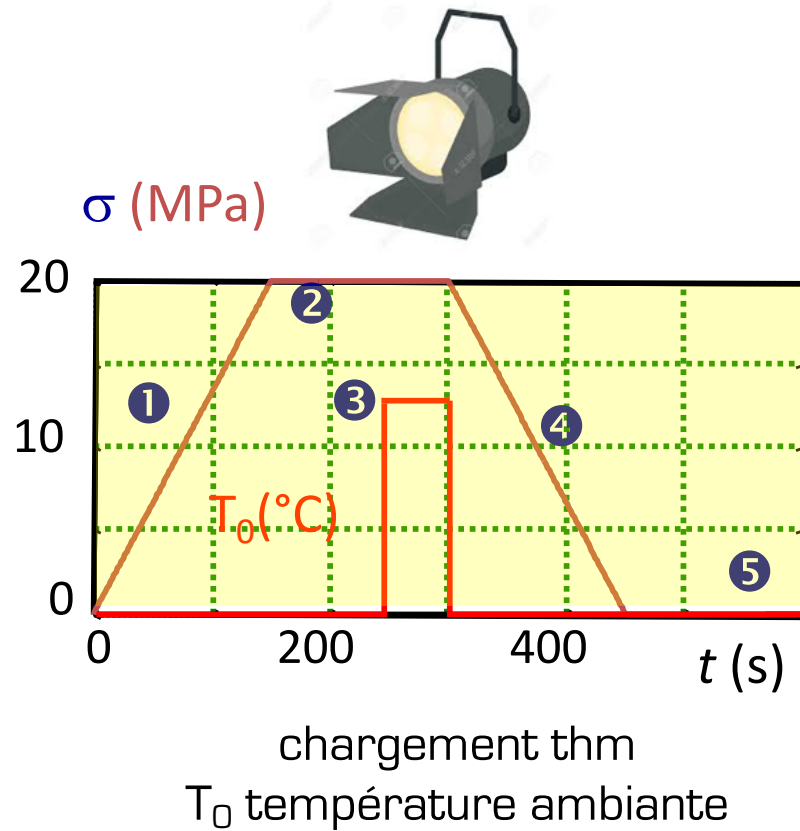

Sens du fluage induits par les échanges
 de chaleur entre l'éprouvette et le milieu extérieur

Couplage + diffusion = effet d'échelle

Trajectoires thermomécaniques

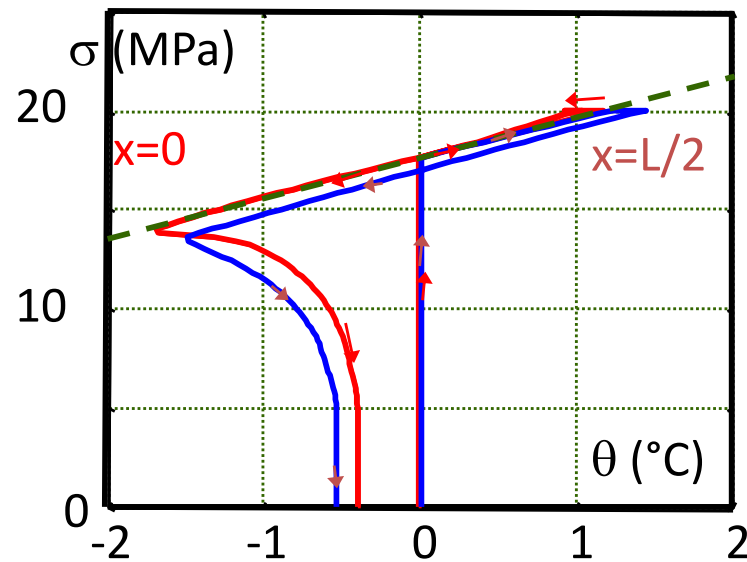

Réponses mécaniques

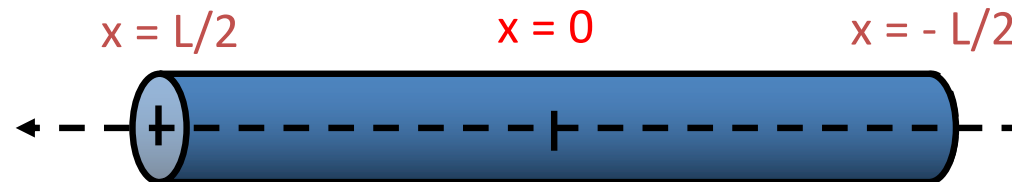
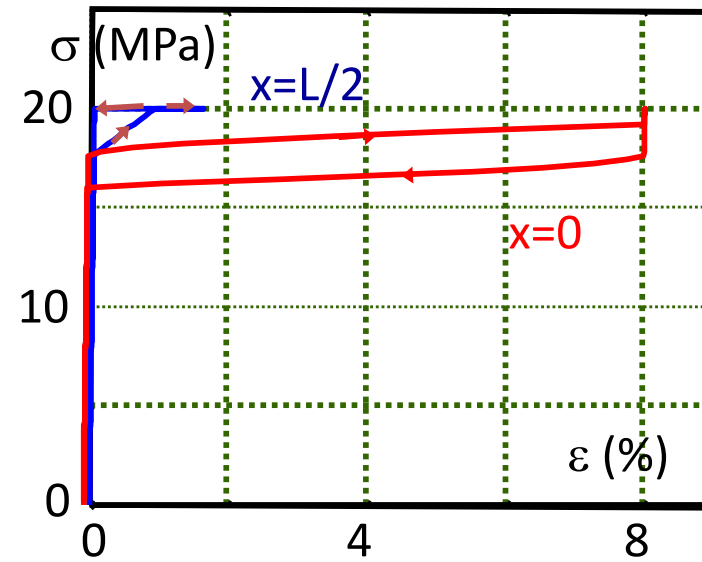

réponses locales \neq réponse globale
 identification des équations de comportement

Essai numérique (III)

Test de dilatométrie ($\sigma = \text{Cte}$)



Domaine de transition ($A - M = 10^{-3} \text{ } ^\circ\text{C}$)

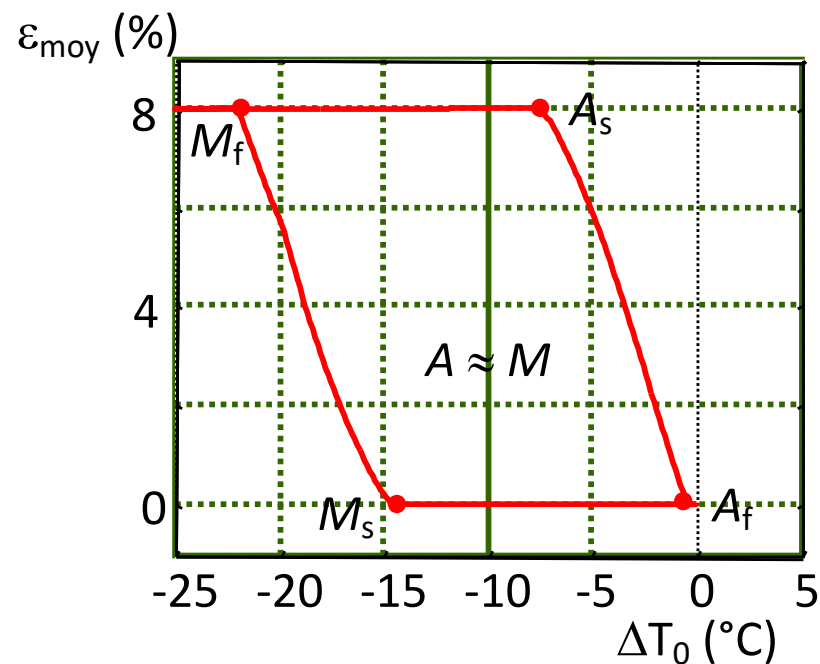
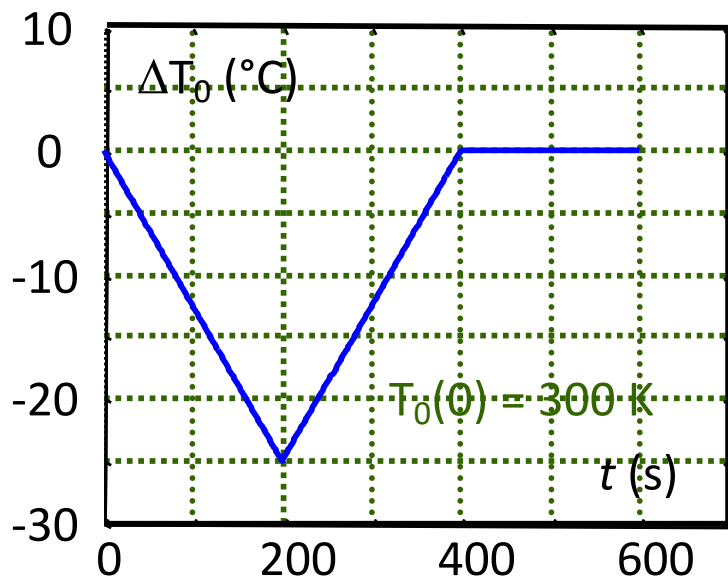

Diffusion de la chaleur, inertie thermique ...

$A - M = 10^{-3} \text{ } ^\circ\text{C}$: domaine de transition du matériau

A_s, A_f, M_s, M_f : domaine de transition de l'échantillon

Load-unload cycles

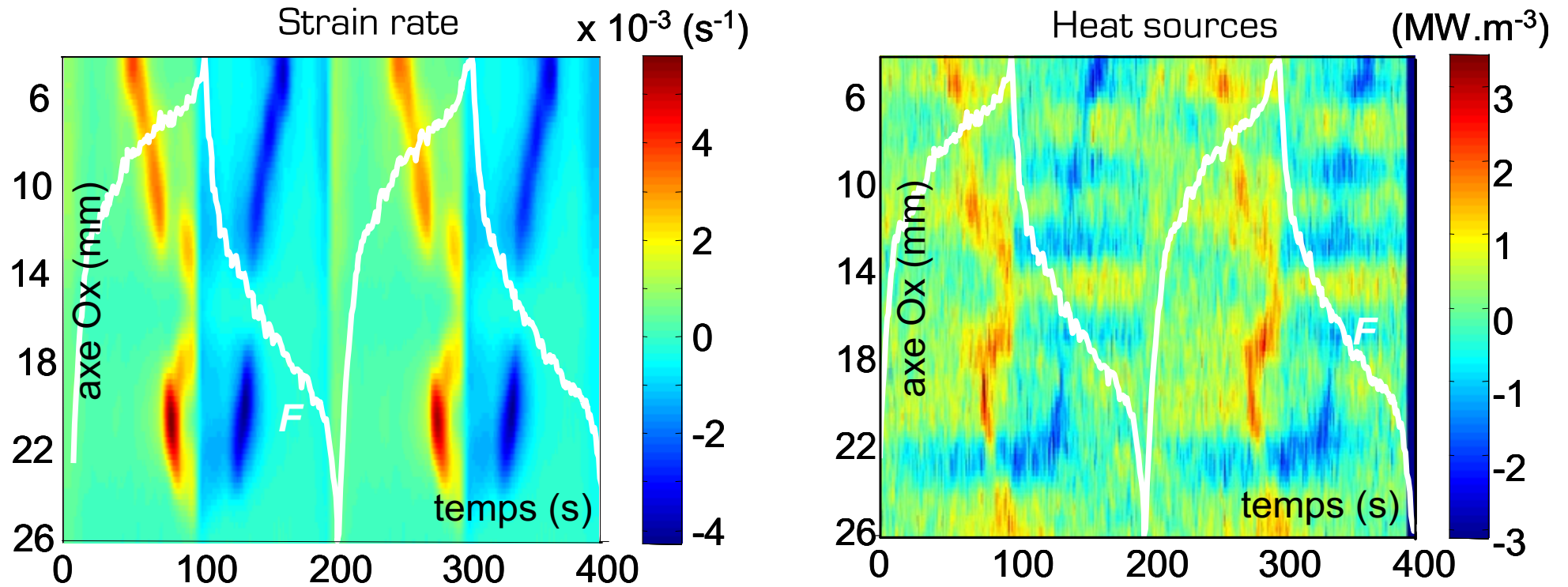

Field of local responses (mesoscale)

[S. Vigneron, PhD 09]





Effet du temps : viscosité ou couplage fort et dissipation thermique

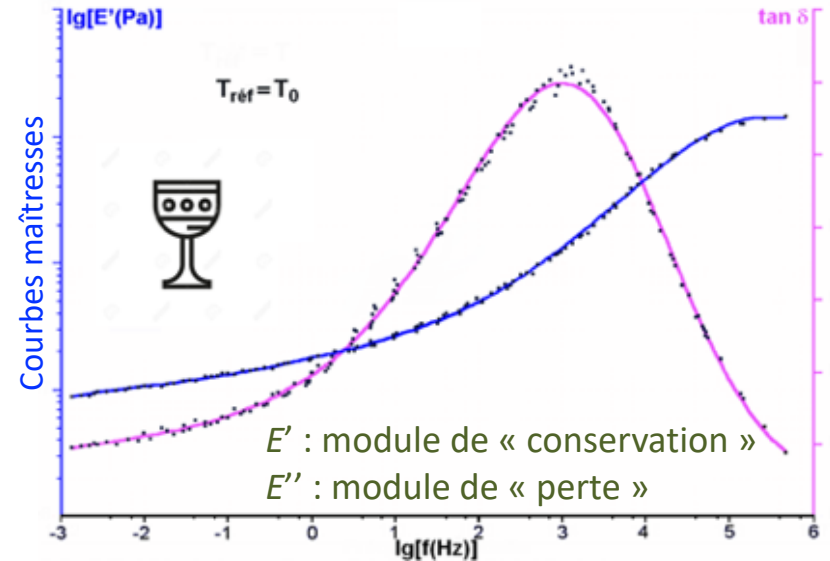

$$\begin{cases} \varepsilon = \frac{\sigma}{E} + \lambda_{th}(T - T_0) \\ \dot{T} + \frac{T - T_0}{\tau_{th}} = -\frac{E\lambda_{th}T\dot{\varepsilon}}{\rho C} \end{cases}$$

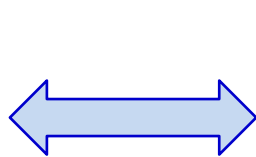

« OD » approach
linear heat losses

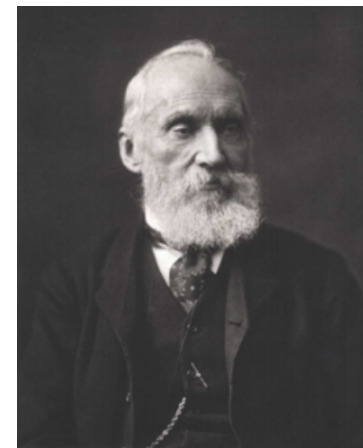

W. Thomson – Lord Kelvin
1824-1907

$E = 1000 \text{ MPa}$
 $\rho = 1000 \text{ kg.m}^{-3}$
 $C = 1000 \text{ J.kg}^{-1}.\text{K}^{-1}$
 $\lambda_{th} = 50 \cdot 10^{-5} \text{ K}^{-1} \times \mathbf{100}$
 $\tau_{th} = 30 \text{ s}$
 $T_0 = 294 \text{ K}$

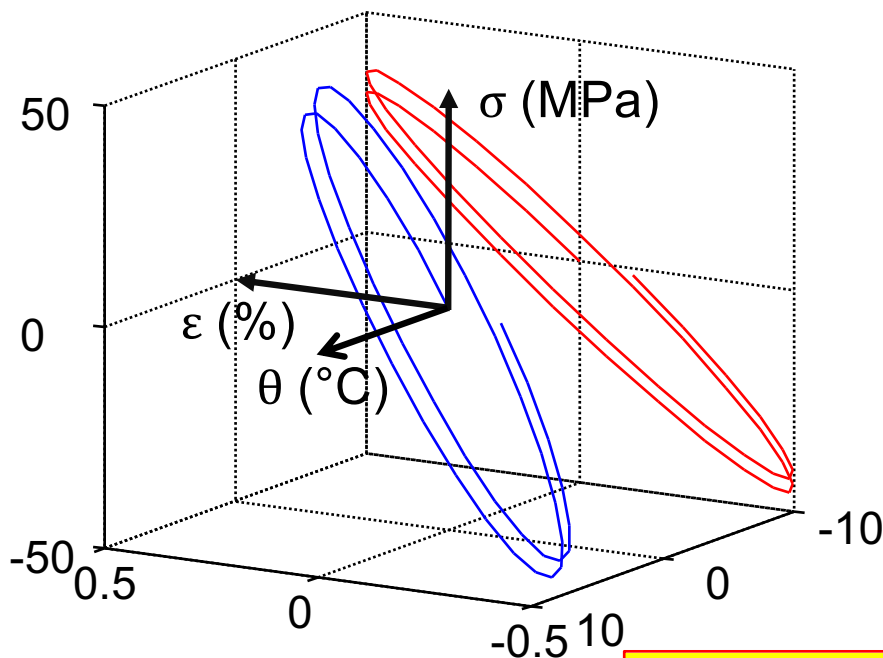

Toward a
stabilised
cycle...

Thm couplings + thermal dissipation

$$\tilde{W}_{def} = A_h = \tilde{W}_{the}$$

Couplage ou dissipation ?

Couplage thermomélastique (i.e. $d_1=0$)
couplage fort

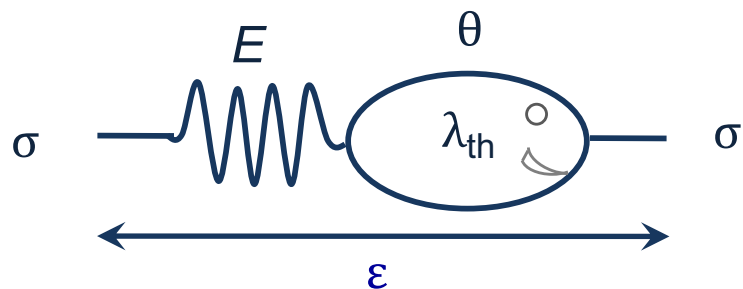

variables d'état (θ, ε)

$$\begin{cases} \varepsilon = \frac{\sigma}{E} + \lambda_{th} \theta \\ \dot{\theta} + \frac{\theta}{\tau_{th}} = -\frac{E\lambda_{th}(T_0 + \theta)\dot{\varepsilon}}{\rho_0 C_0} \end{cases}$$

équation rhéologique

$$\sigma + \tau_{th} \dot{\sigma} \approx E\varepsilon + E\tau_{th}(1 + \chi)\dot{\varepsilon} \quad (T/T_0 \approx 1)$$

Processus dissipatif visqueux
couplage faible

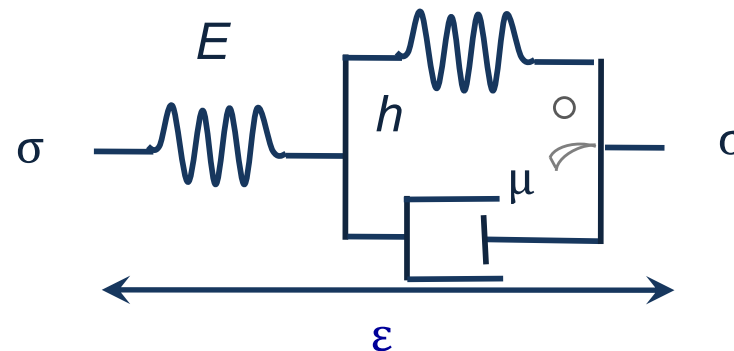

variables d'état ($\varepsilon, \varepsilon_v$)

$$\begin{cases} \sigma = E(\varepsilon - \varepsilon_v) \\ \sigma = h\varepsilon_v + \mu \dot{\varepsilon}_v \end{cases}$$

équation rhéologique

$$\sigma + \frac{\mu}{E+h} \dot{\sigma} = \frac{Eh}{E+h} \varepsilon + \frac{E\mu}{E+h} \dot{\varepsilon}$$



Visco-analyse de polymère (DMA)

Effets thermoélastiques : couplage fort

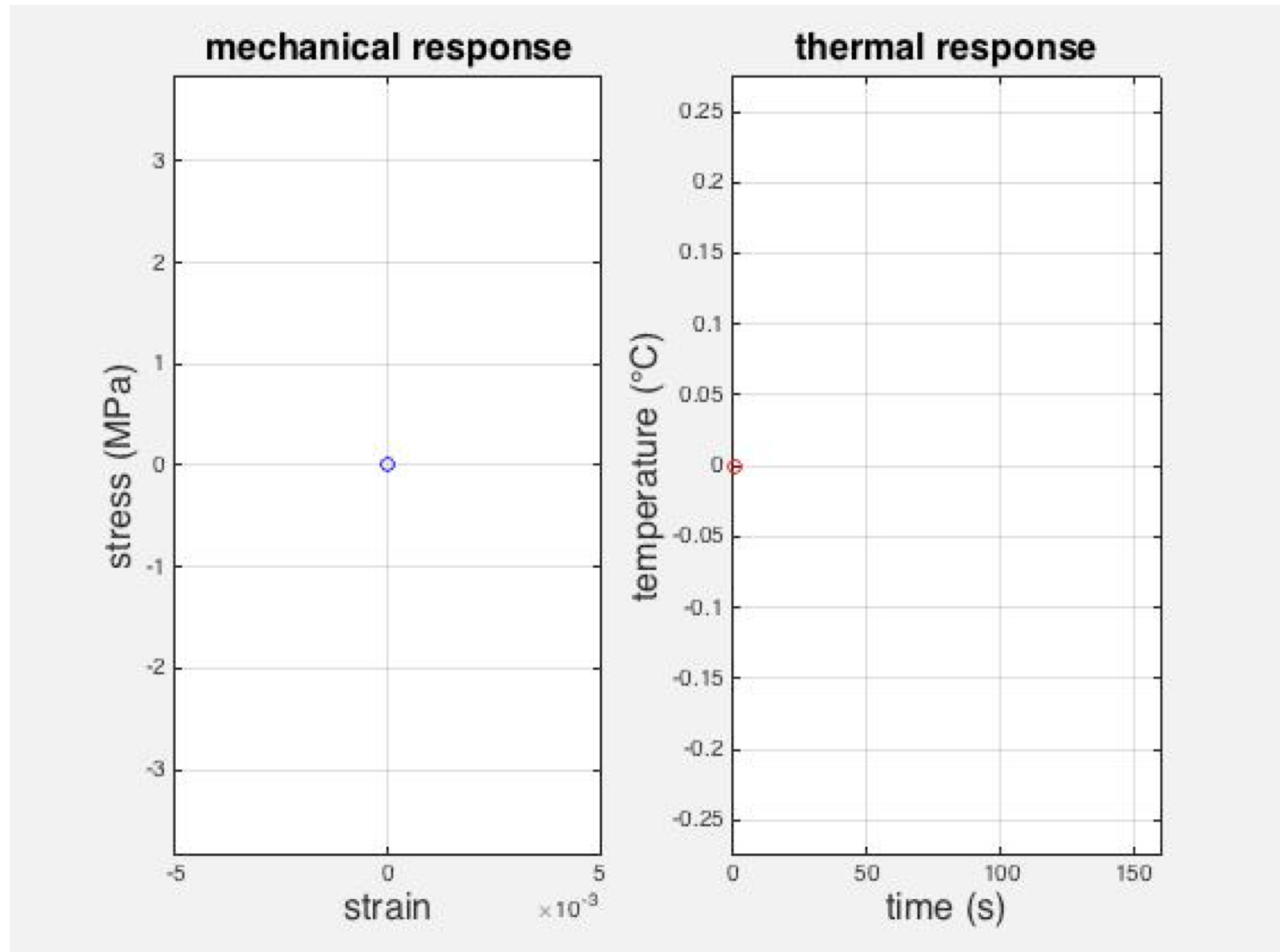

Effets visqueux : couplage faible

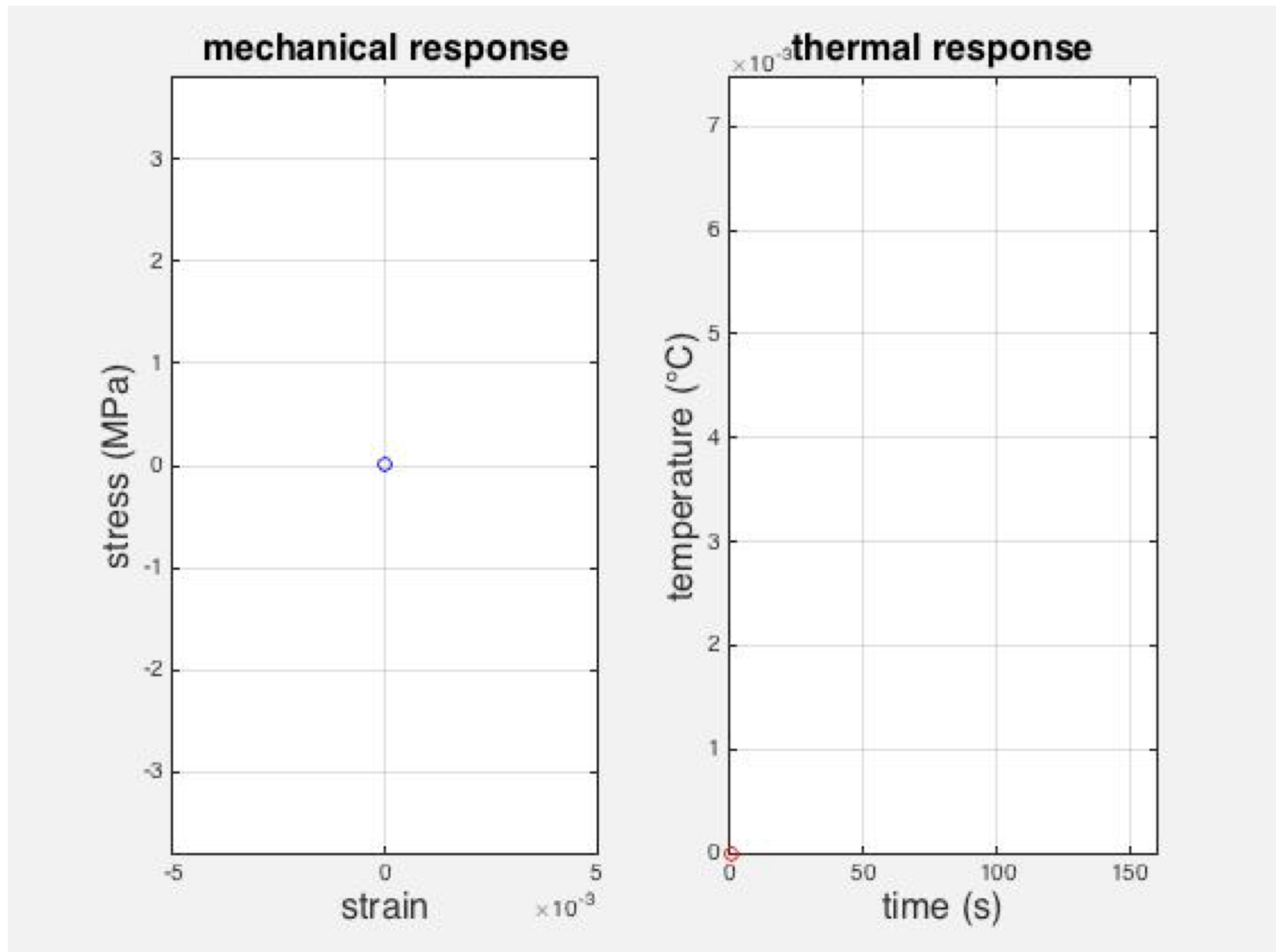
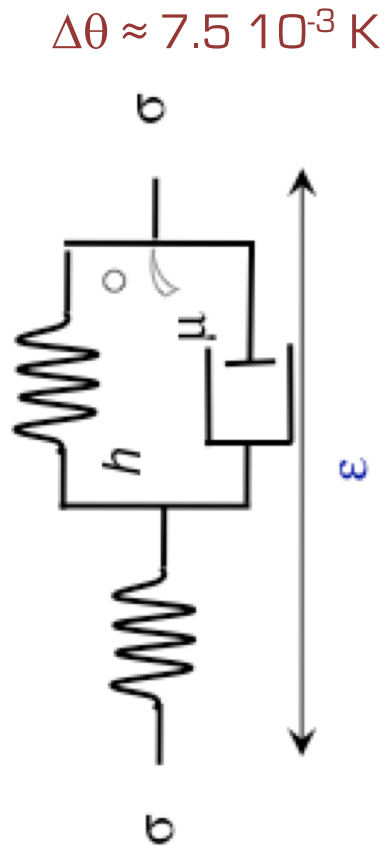

Energy balance : comparison

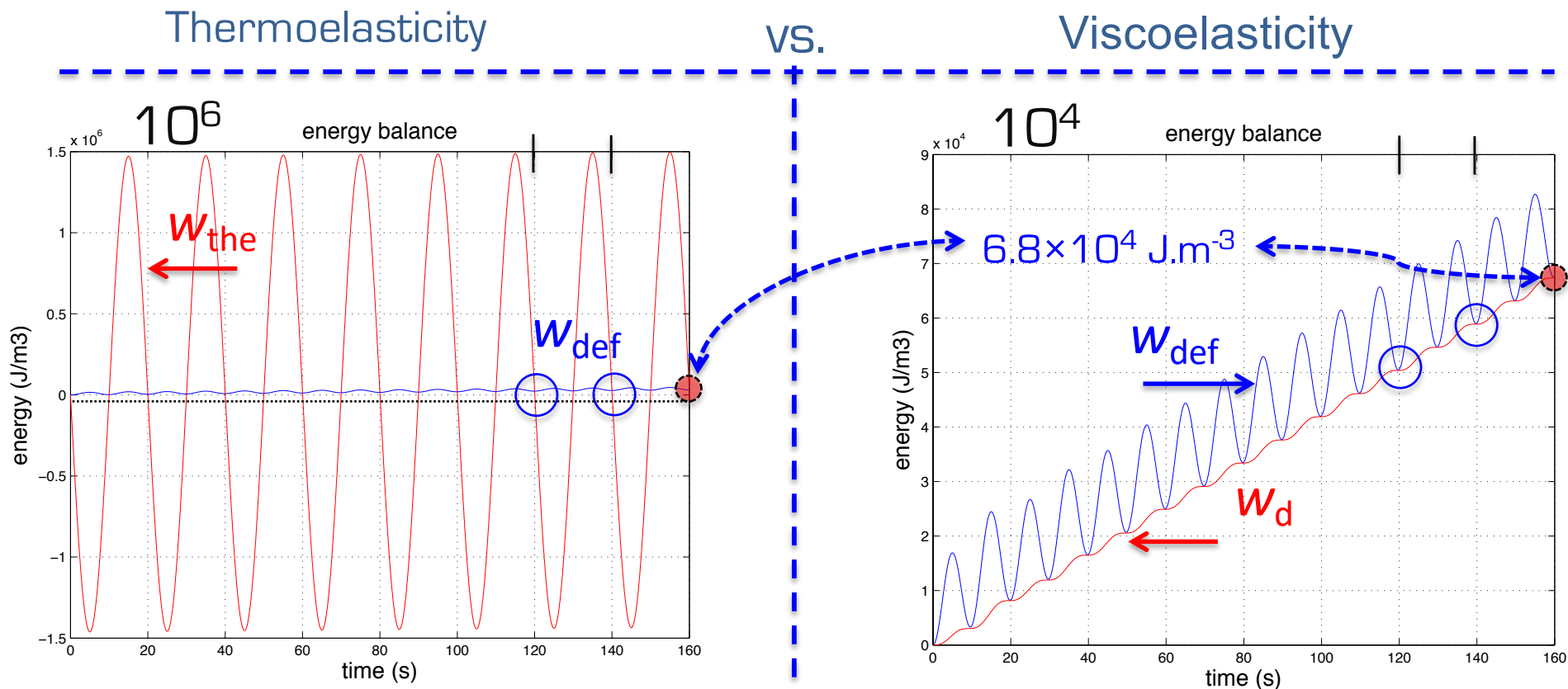

$\Delta W_{the} \gg \Delta W_{def}$

Δ = ranges

$W_d \leq W_{def}$

$W_{the} = W_{def}$

\bigcirc = end of cycle

$W_d = W_{def}$

PMMA & PC : polymères à l'état vitreux

HPP isotherme : le royaume de la viscoélasticité linéaire

J. Alfrey [48], M. Biot [65], F. Sidoroff [70-75]

Equivalence of series and parallel models [e.g. P.T. and Z. models]

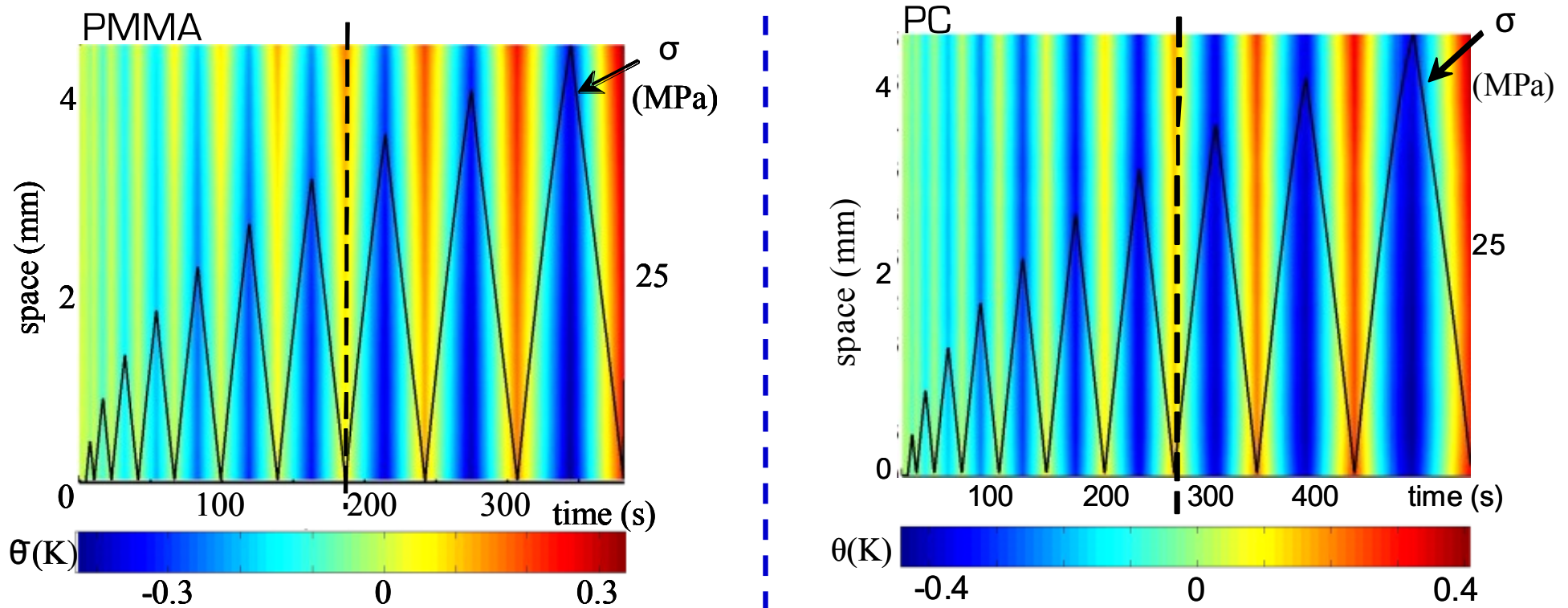

[S. Moreau, PhD 03]



PMMA and PC : simple models for glassy polymers

[PhD, Moreau S., CRAS 2005]

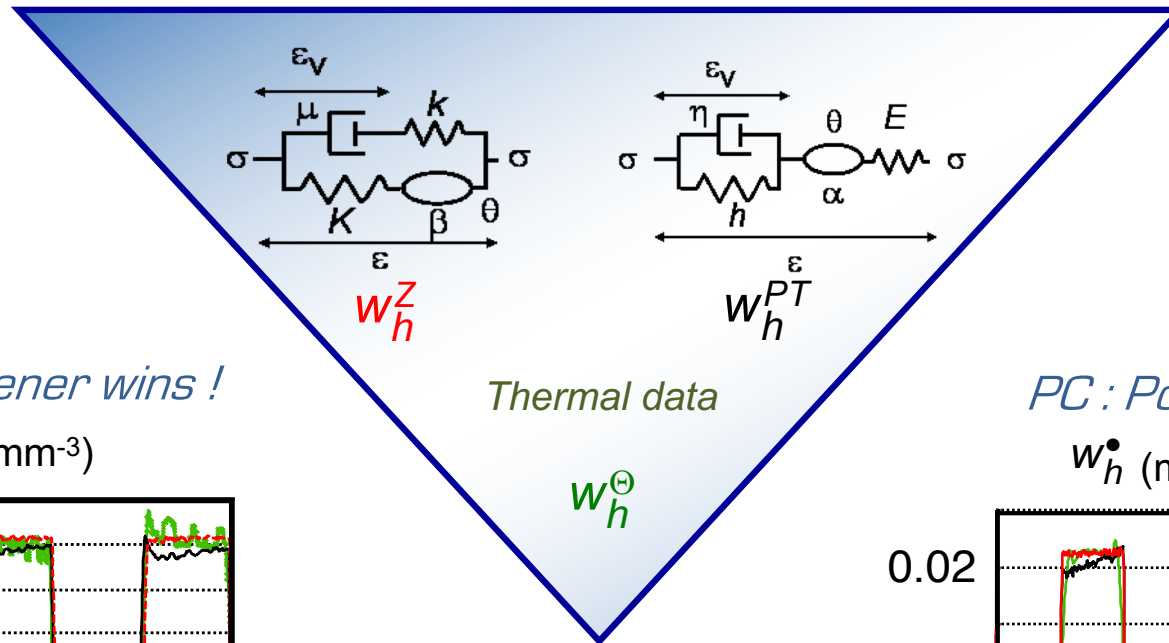

PMMA : Zener wins !

W_h^\bullet (mW.mm⁻³)

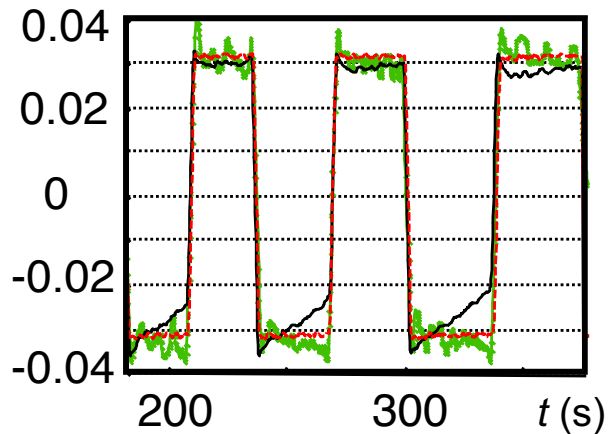

PC : Poynting wins !

W_h^\bullet (mW.mm⁻³)

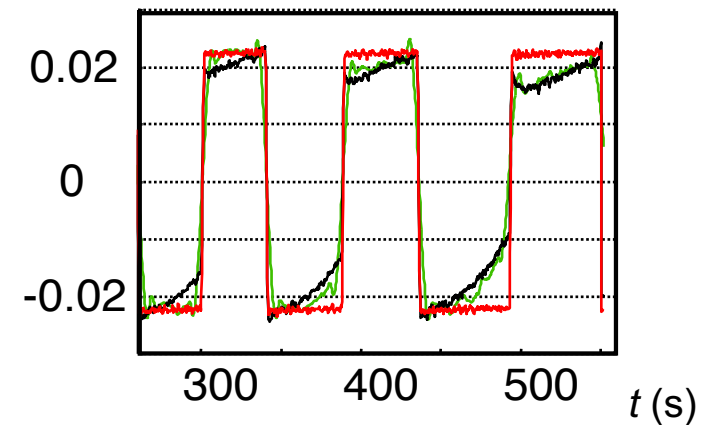

$A_h \approx W_{the} ?$

Low dissipative effects ! energy storage ?
Equivalence of series and parallel models ?

Wet polyamide 6.6 (III)

[A. Benaarbia et al., MoM, 16]

Local “thermoelastic” temperature ranges

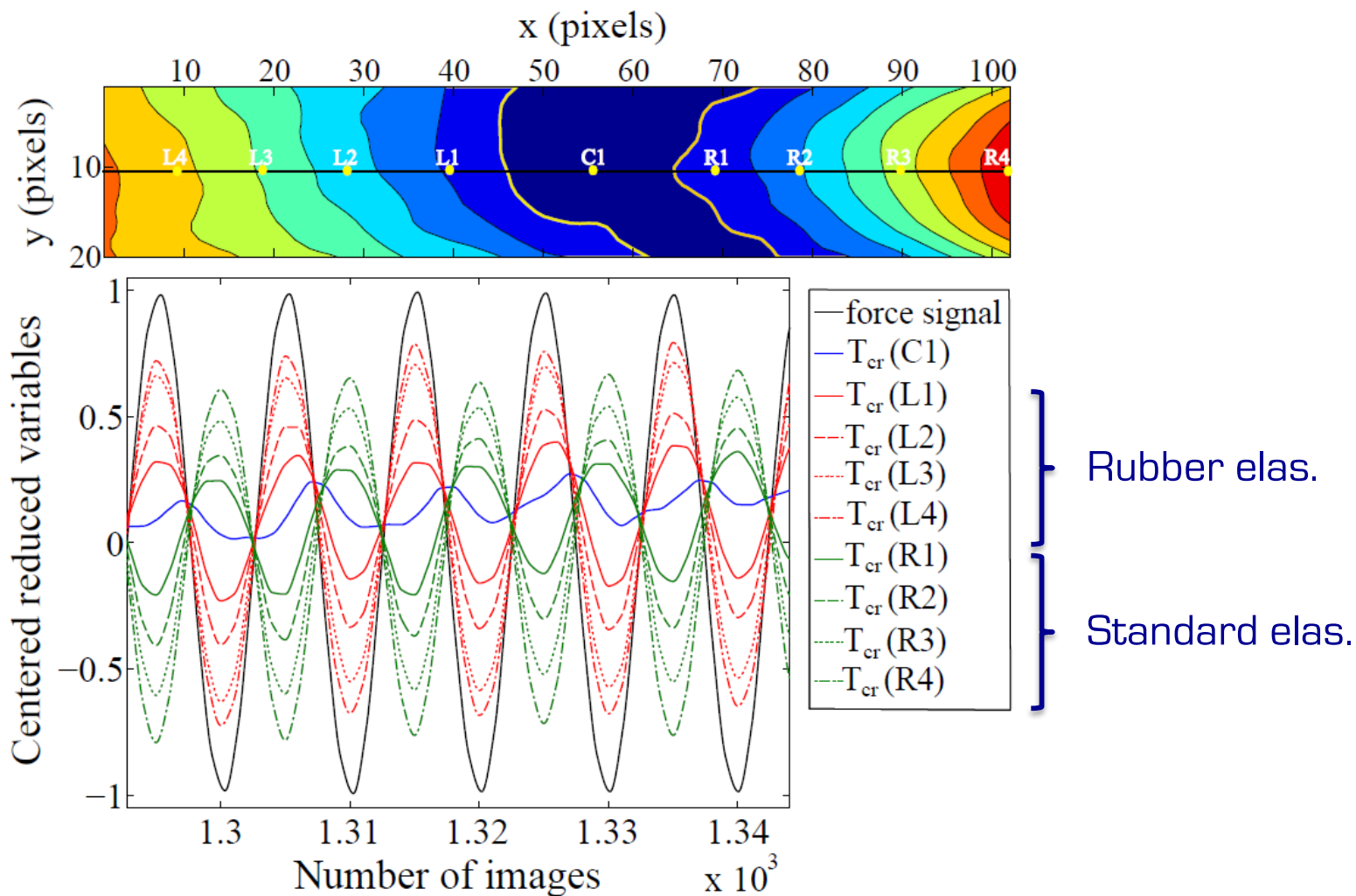

RH = 80%
 $F_L = 1$ Hz
 $R_s = 0.1$
 $D_s = 40$ MPa
 Cycle #100

Stabilisation cyclique : polymères

Viscoélasticité linéaire : équivalence temps température (TTS - DMA)

Facteur de translation $a_{T_0}^T$

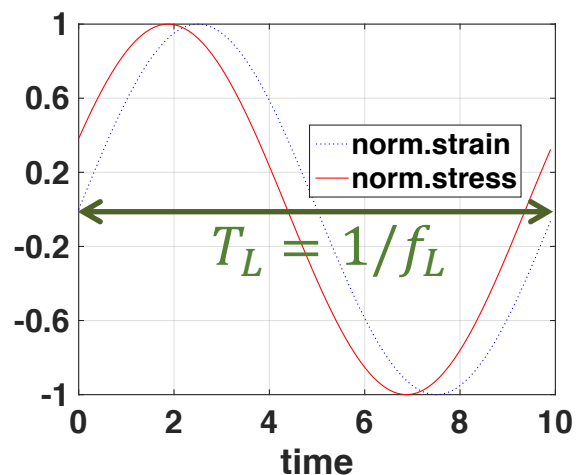

$$\varepsilon = \varepsilon_0 \sin(2\pi f_L t)$$

$$\sigma = \sigma_0 \sin(2\pi f_L t + \varphi)$$

$$\sigma = E' \varepsilon_0 \sin(2\pi f_L t) + E'' \varepsilon_0 \cos(2\pi f_L t)$$

$$\tan(\delta) = \frac{E''}{E'}$$

Pertes
Enr. Diss.

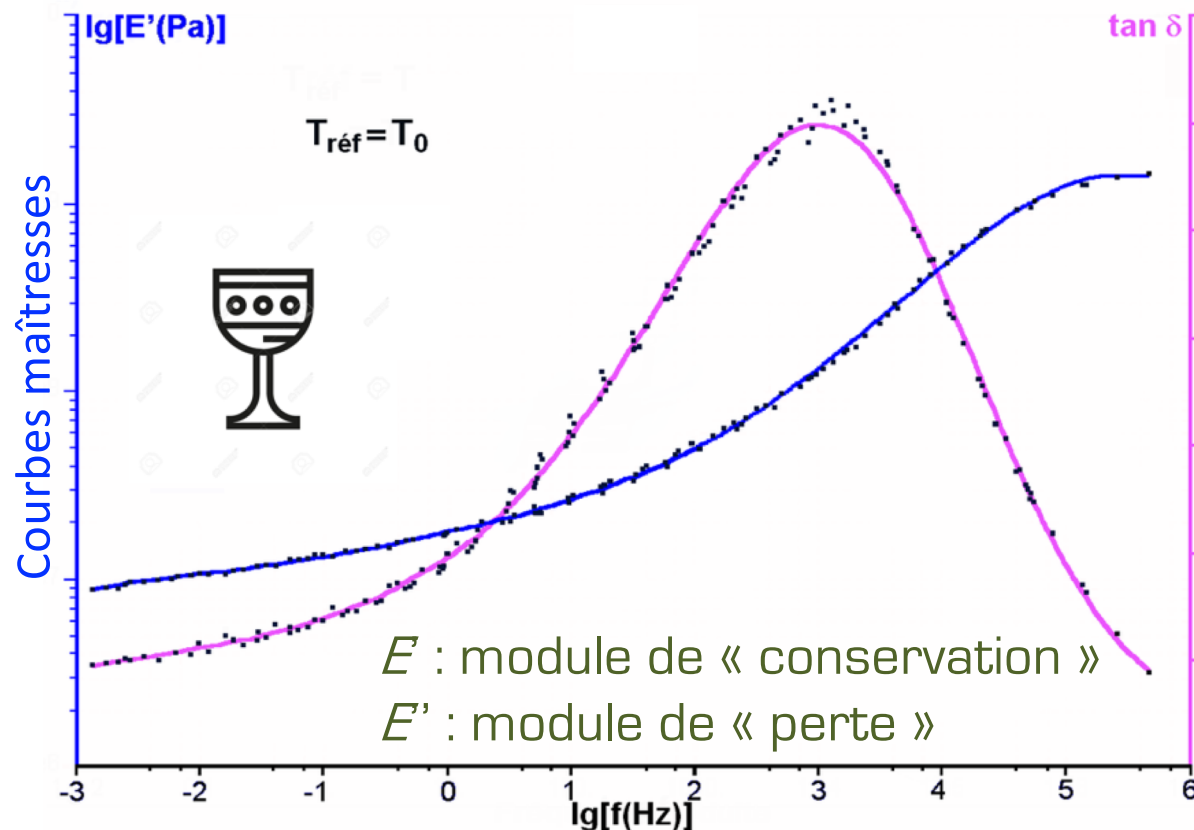

$$E'(f_L, T) = E'(f_L/a_{T_0}^T, T_0)$$

$$E''(f_L, T) = E''(f_L/a_{T_0}^T, T_0)$$

Analyse dynamique mécanique (TTS)

Idée : basse température + basse vitesse

haute température + haute vitesse

« = » même mobilité moléculaire

Modèle de Maxwell généralisé
« anisotherme »

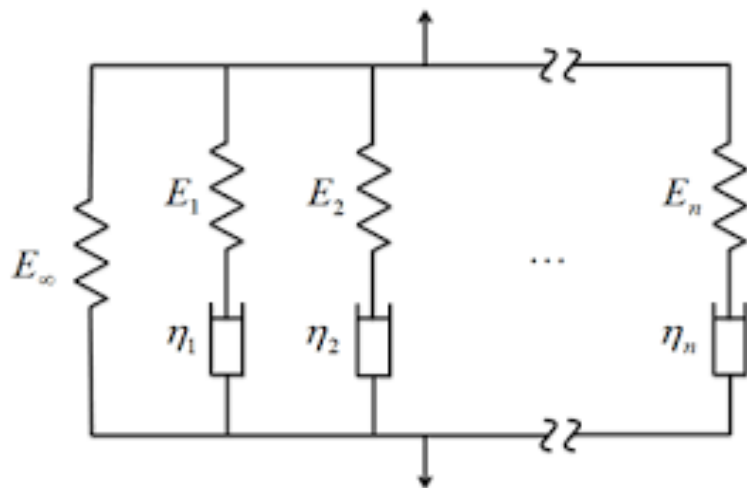

température = paramètre du modèle ...

$$\tau_i = \mu_i / E_i = \tau_i^0 f(T)$$

Quelques ingrédients théoriques :

$$E' = E_\infty + \sum_1^N \frac{E_i \tau_i^2 \omega^2}{1 + \tau_i^2 \omega^2}$$

$$E'' = \sum_1^N \frac{E_i \tau_i \omega}{1 + \tau_i^2 \omega^2}$$

Arrhenius (ou WLF ou ...)

$$\tau_i = \tau_i^0 \exp\left(-\frac{E_a}{R} \left(\frac{1}{T} - \frac{1}{T_0}\right)\right)$$

La température est une variable contrôlée ($T = T_{DMA}$)

Wet polyamide 6.6 (I)

[A. Benaarbia et al., MoM, 16]

Overall mechanical responses

Stress-strain loops

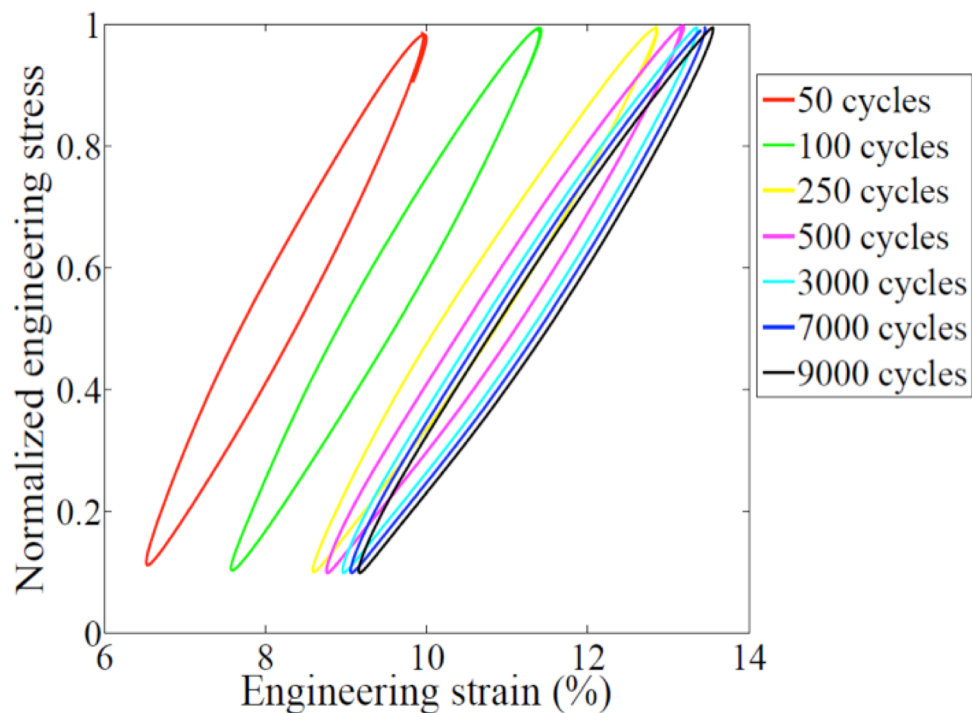

Loop parameters

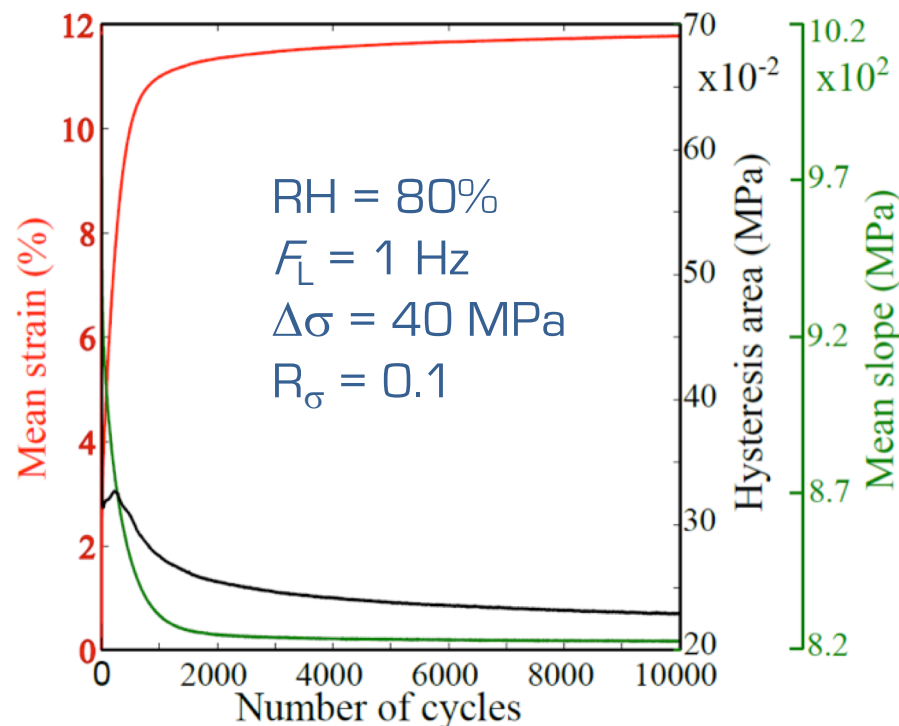

- ✓ Strong initial changes
- ✓ Towards a gradual cyclic stabilization ?

Wet polyamide 6.6 (II)

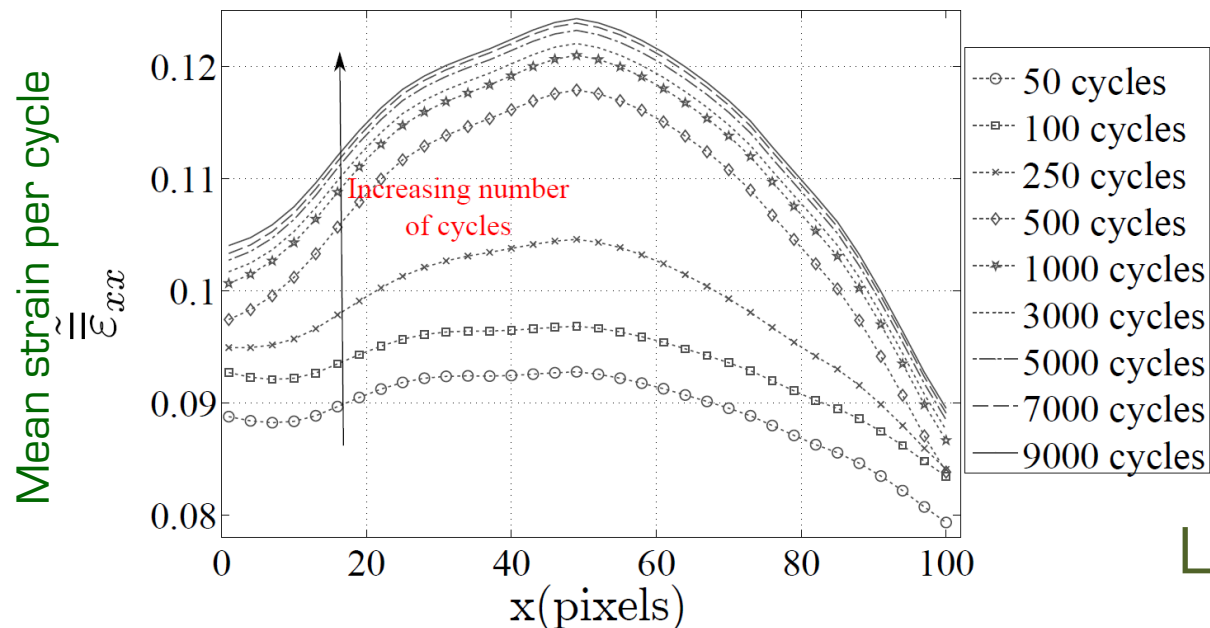

Strain concentration [0,500]
 Progressive stabilization [1000,9000]

Localization of dissipation [0,500]
 Progressive stabilization [1000,9000]

Longitudinal profiles

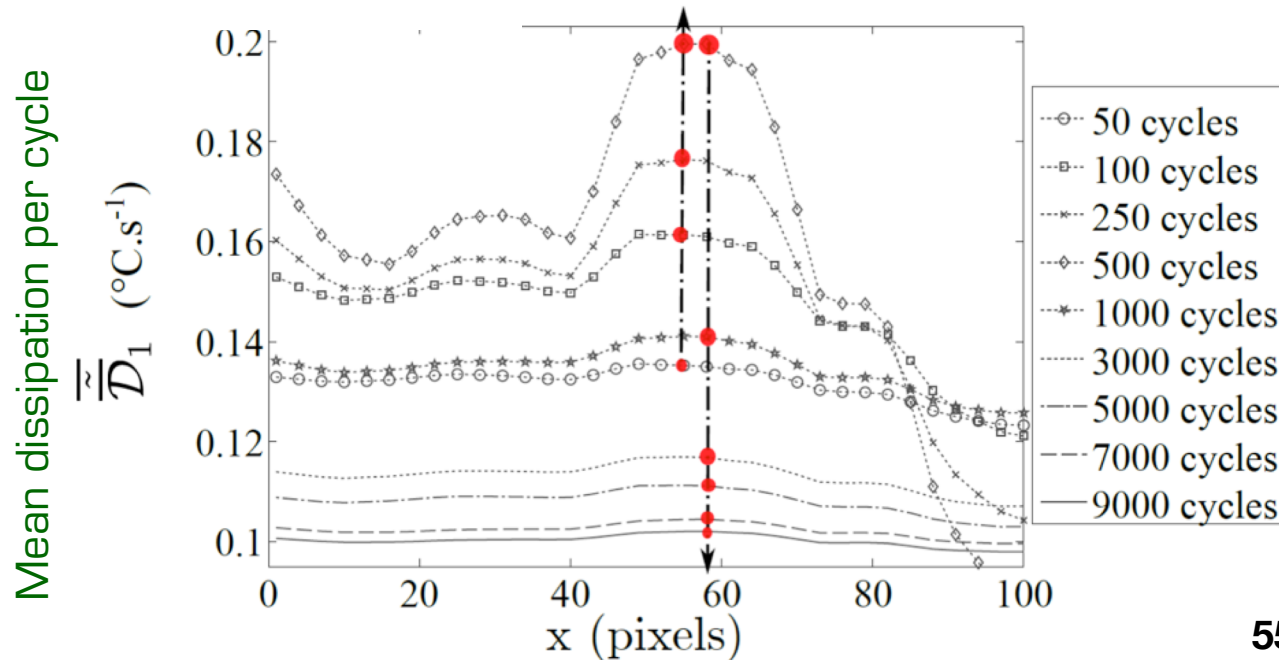

Wet polyamide 6.6 (III)

Comments



- ✓ **Self heating** induced by dissipation (20 °C)
- ✓ Glass transition temperature T_g (close to RT !)
- ✓ From glassy material to rubbery material ??
- ✓ **Water plasticizing** ($T_g \searrow$ when $RH \nearrow$)
- ✓ Chemical ageing
- ✓ Thermo-hydro-chemio-mechanical modeling
- ✓ **Role of glass fibers** ... multiscale approach
- ✓ Structures designed for **fatigue**

