

# Plasticity, dissipation and energy storage in metallic polycrystals

Eric CHARKALUK

Laboratoire de Mécanique de Lille - CNRS UMR 8107, France  
eric.charkaluk@ec-lille.fr

LABORATOIRE  
de MÉCANIQUE  
de LILLE  
UMR CNRS 8107



## Why metallic polycrystals?

- ▶ Long history on metals and thermomechanical couplings
  - ▶ Lord Kelvin on thermoelasticity [Kelvin, 1853-1878]
  - ▶ Taylor on thermoplasticity, latent heat and energy storage [Taylor et al., 1925-1937]
  - ▶ Chrysochoos on energy balance and infrared thermography [Chrysochoos et al., 1987-]
- ▶ Metals are (poly)crystals
  - ▶ Crystal elasticity and plasticity [Cottrell, Oxford press, 1953]
  - ▶ Grain boundaries, twins, ... [Kelly and Knowles, Wiley, 2012]
  - ▶ Local heterogeneities, strain localization, plasticity mechanisms [Jaoul, Dunod, 1965, new ed.: Presses des Mines, 2008]

## A simple monotonic tensile test

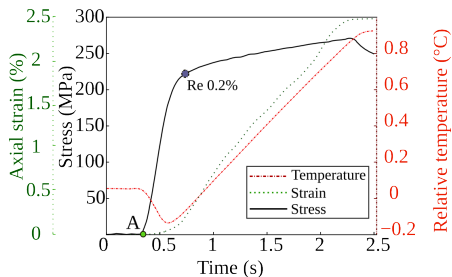

Tensile test at  $5 \cdot 10^{-3} \text{ s}^{-1}$

- ▶ temperature variations?
- ▶ energy balance?

1,776 grains on surface

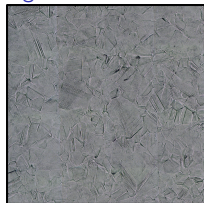

surface microstructure ( $5 \times 5 \text{ mm}^2$ )

## Outline

Few reminders on metal plasticity

A multiscale framework to describe metallic polycrystals: from atoms to test specimens

- Crystal plasticity, yield stress and strain hardening

- A simple model of structural hardening: the three-bar truss

Energy storage and dissipation: from global to local measurements

- Macroscopic framework: the Generalized Standard Materials

- Some experimental evidences

- Macroscopic energy balance

- Energy balance within polycrystals

- Grains and/or crystals

Conclusions and prospects

## **Few reminders on metal plasticity**

## Plasticity: some facts

### Observations

- ▶ an initial domain: linear relation between stress and strain
- ▶ a threshold
- ▶ "hardening": deformation requires more effort
- ▶ residual strain after unloading: plastic strain

### Tensile test

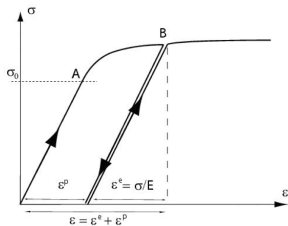

## Plasticity: some equations

### Elasticity and yield criterion

- ▶  $\boldsymbol{\varepsilon} = \boldsymbol{\varepsilon}^e + \boldsymbol{\varepsilon}^p$
- ▶  $\boldsymbol{\sigma} = \mathbb{C} : \boldsymbol{\varepsilon}^e = \mathbb{C} : (\boldsymbol{\varepsilon} - \boldsymbol{\varepsilon}^p)$
- ▶ von Mises:
 
$$f(s_{ij}) = \sqrt{J_2} - \sigma_0 = \sqrt{\frac{3}{2} \mathbf{s} : \mathbf{s}} - \sigma_0$$
- ▶ with:  $\mathbf{s} = \boldsymbol{\sigma} - \frac{1}{3} \text{tr}(\boldsymbol{\sigma}) \mathbf{I}$
- ▶ yield criterion:  $f \leq 0$
- ▶ uniaxial:  $|\sigma| \leq \sigma_0$

### Tensile test

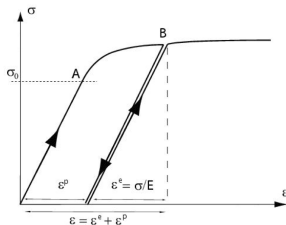

## Initial yield surface

### Tension-torsion test

- ▶  $f = \sqrt{\frac{3}{2} \mathbf{s} : \mathbf{s}} - \sigma_0$
- ▶  $\sqrt{\sigma^2 + 3\tau^2} = \sigma_0$  (in red)
- ▶  $\tau_0 = \frac{\sigma_0}{\sqrt{3}}$
- ▶ (Tresca:  
 $\sqrt{\sigma^2 + 4\tau^2} = \sigma_0$ , in blue)

### Experimental results

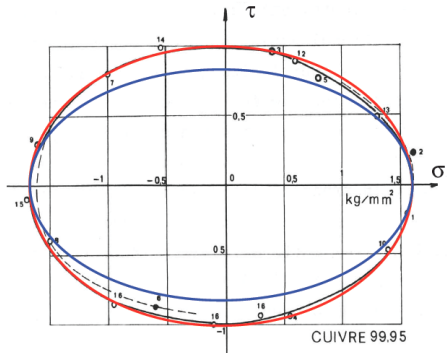

[Bui, Paris VI thesis, 1969]



## Cyclic hardening

### Isotropic hardening

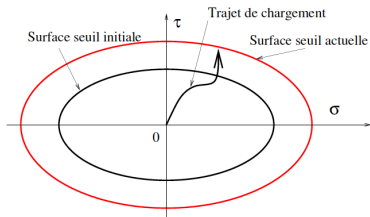

$$\blacktriangleright f = \sqrt{\frac{3}{2} \mathbf{s} : \mathbf{s}} - R - \sigma_0$$

### Kinematic hardening

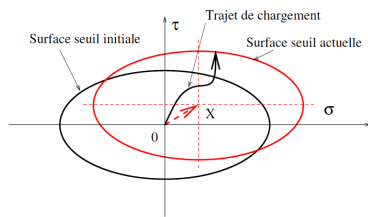

$$\blacktriangleright f = \sqrt{\frac{3}{2} (\mathbf{s} - \mathbf{X}) : (\mathbf{s} - \mathbf{X})} - \sigma_0$$

[Suquet, Rupture et Plasticité, Ecole Polytechnique, 2004]

## Cyclic hardening

### Isotropic hardening

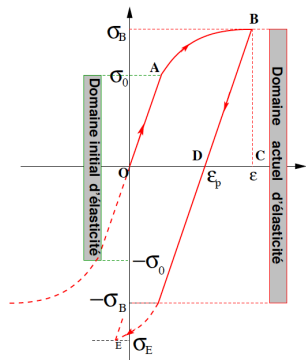

### Kinematic hardening

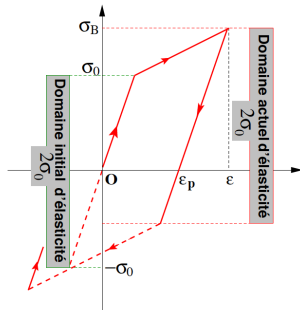

[Maitournam, Mécanique des structures anélastiques, Ecole Polytechnique, 2014]

## **A multiscale framework to describe metallic polycrystals**

## From atoms to test specimens

- ▶ Atomic nanometric scale: periodic array, **crystallographic structures** (face-centred cubic, body-centred cubic, hexagonal, . . . ),
- ▶ Microscopic scale: **crystal**, fixed array orientation
- ▶ Mesoscopic scale (hundred of microns): **polycrystal**
- ▶ Macroscopic scale (centimetres): laboratory test specimen
- ▶ Engineering scale (centimetres to meters): structures

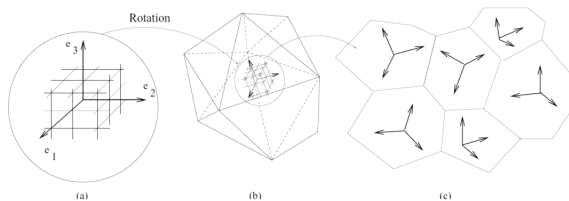

[Suquet, Rupture et Plasticité, Ecole Polytechnique, 2005]

- └ A multiscale framework to describe metallic polycrystals: from atoms to test specimens
  - └ Crystal plasticity, yield stress and strain hardening

## Plastic slip in crystals

Plastic deformation in single crystals: slip planes, glide lamella



[Cottrell, Dislocations and plastic flow in crystals, Oxford, 1953]

- └ A multiscale framework to describe metallic polycrystals: from atoms to test specimens
- └ Crystal plasticity, yield stress and strain hardening

## Plastic slip and dislocations

Dislocations: line defect in crystals ( $10^{13} \text{cm}^{-3}$ )

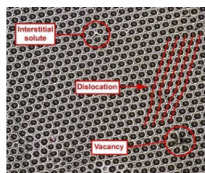
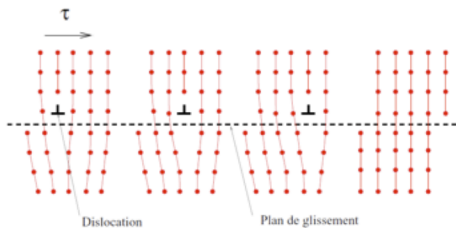

## Slip planes

- ▶ dense planes (minimum energy)
- ▶ depend on the crystallographic structure (FCC, BCC, Hexagonal, ...)
- ▶ maximum shear stress

### FCC particular case

- ▶ 4 dense planes (octahedral planes: normal  $\underline{n}$  [111])
- ▶ 3 invariant slip directions  $\underline{m}$
- ▶ 12 possible slip planes

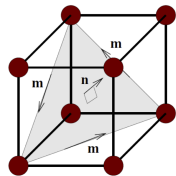

- └ A multiscale framework to describe metallic polycrystals: from atoms to test specimens
  - └ Crystal plasticity, yield stress and strain hardening

## Single crystals

Slip plane and slip direction : one single slip system



[Cottrell, Dislocations and plastic flow in crystals, Oxford, 1953]



- └ A multiscale framework to describe metallic polycrystals: from atoms to test specimens
- └ Crystal plasticity, yield stress and strain hardening

## Single crystals

Slip plane and slip direction : two slip systems

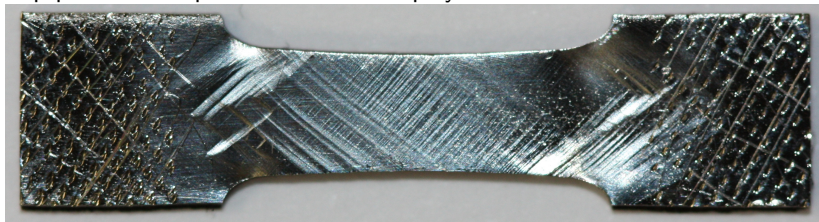

[Wang, PhD thesis, Lille, 2014]

## Single crystals

### Plastic deformation

- ▶ single crystal: fixed orientation
- ▶ shear stress and strain on slip planes
- ▶ isotropic and/or kinematic hardening

### Cyclic hardening

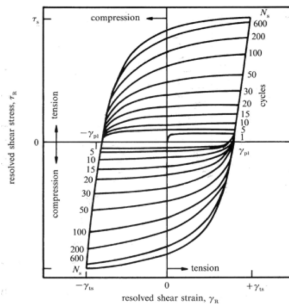

[Suresh, Fatigue of Materials, Cambridge, 1998]

## Crystal plasticity

### Geometry of slip planes

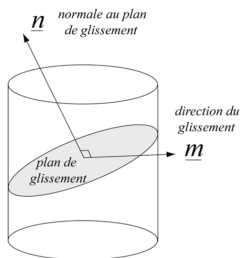

### Crystal plasticity framework

$$\underline{\varepsilon} = \underline{\varepsilon}^e + \underline{\varepsilon}^p$$

$$\underline{\Delta} = \underline{n} \overset{s}{\otimes} \underline{m} = \frac{1}{2}(\underline{n} \otimes \underline{m} + \underline{m} \otimes \underline{n})$$

$$\gamma^p = 2\underline{\varepsilon}^p : \underline{\Delta}$$

$$\underline{\tau} = \underline{\sigma} : \underline{\Delta}$$

$$\text{Schmid's law: } |\underline{\tau} - X| - \tau_0 - R = 0$$

$R$  and  $X$ : isotropic and kinematic hardening variables

## From single- to polycrystals

- ▶ Crystallographic orientations: Electron Back Scattered Diffraction (EBSD)
- ▶ Orientations distribution, crystallographic textures, ...
- ▶ Local heterogeneities from grains to grains

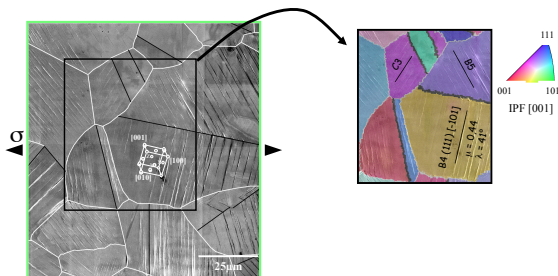

## From single- to polycrystals

- ▶ Oligocrystals, submitted to homogenous stress boundary conditions
- ▶ Different crystallographic orientations

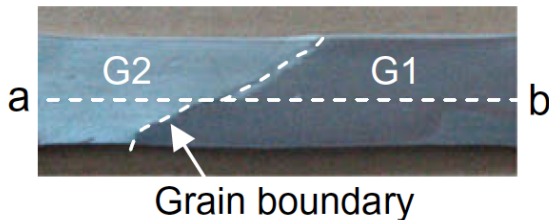

[Saai et al., Mech. Mat., 2010]

## A simple model: the three-bar truss (1/4)

- ▶ Considering three glued crystals submitted to the same force at their boundaries,
- ▶ Two different orientations,
- ▶ Perfect plasticity: yield stress  $N_0$

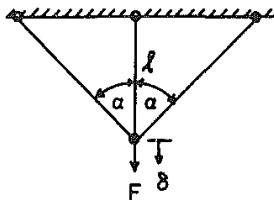

## A simple model: the three-bar truss (2/4)

### Solution

- ▶ bars only in tension-compression, section  $A$ ,

- ▶ 
$$\sum_{i=1}^3 N_i \underline{t}_i = \underline{F},$$

- ▶ yield criterion:  $|N_i| \leq N_0$

### Elasticity

- ▶ 
$$F = \frac{AE\delta}{l} (1 + 2 \cos^3 \alpha) \text{ for } \delta \leq \frac{N_0 l}{AE}$$

## A simple model: three-bar truss (3/4)

### Plasticity and limit load

- ▶  $F = N_0 + \frac{2AE\delta}{l} \cos^3 \alpha$  for  $\frac{N_0 l}{AE} \leq \delta \leq \frac{N_0 l}{AE \cos^2 \alpha}$
- ▶  $F = F_{lim} = N_0(1 + 2 \cos \alpha)$  for  $\delta \geq \frac{N_0 l}{AE \cos^2 \alpha}$

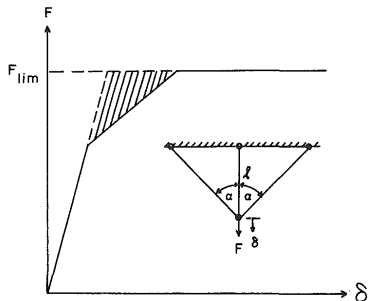

[Leckie et al., J. Eng. Mat. tech., 1990]



## A simple model: three-bar truss (4/4)

### Residual stresses

- ▶  $\sigma_v = -2 \frac{N_0}{A} \frac{\sin^2 \alpha \cos \alpha}{1 + 2 \cos^3 \alpha}$ , for the vertical bar (compression),
- ▶  $\sigma_i = \frac{N_0}{A} \frac{\sin^2 \alpha}{1 + 2 \cos^3 \alpha}$ , for the inclined bar (tension).

### Structural hardening

- ▶ Residual stresses due to strain incompatibilities,
- ▶ Despite local perfect plasticity, **structural hardening**

## Extension to polycrystals

### Generalization for an infinite number of perfectly plastic bars

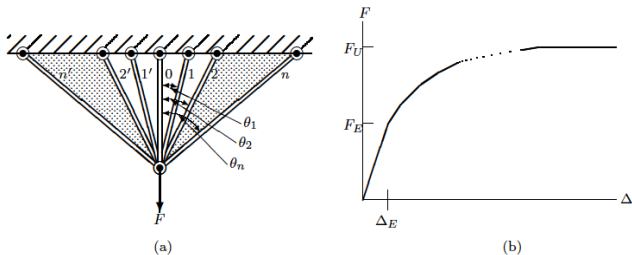

[Lubliner, Plasticity Theory, Dover, 2008]

- ▶ structural kinematic hardening,
- ▶ residual stresses in polycrystals:  $\sigma = \mathbb{A} : \Sigma + \sigma^{res}$ , impact on energy balance (see later).

[Suquet, Element of homogenization theory, 1987]

## Energy storage and dissipation

## Thermomechanical description of the elastic-plastic behaviour of polycrystals

- ▶ elasticity, yield surface and intragranular hardening
- ▶ heterogeneous vs generalized plasticity : residual stresses
- ▶ temperature variations?
- ▶ associated dissipation and stored energy?

## Some equations

## State variables

- ▶  $\varepsilon$ : observable state variable
- ▶  $\varepsilon^P(\alpha)$ : internal kinematic variable depending on  $\alpha$
- ▶  $T$ : observable state variable

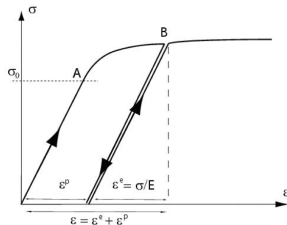

## Free energy potential and state equations

### Free energy potential

- ▶ deformation  $\varepsilon$  is not a dissipative variable: irreversible evolutions characterized by  $\varepsilon^p(\alpha)$
- ▶  $\varepsilon = \varepsilon^e(\sigma) + \varepsilon^p(\alpha)$
- ▶  $\Psi(\varepsilon, \alpha, T) = \Psi_e(\varepsilon - \varepsilon^p, T) + \Psi_\alpha(\alpha)$
- ▶  $\Psi_\alpha(\alpha)$ , stored free energy *or* relaxed state free energy

### State equations

- ▶  $\sigma^r = \rho \frac{\partial \Psi}{\partial \varepsilon}$  ;  $s = -\frac{\partial \Psi}{\partial T}$
- ▶  $\mathbf{A}_{\varepsilon^p} = \rho \frac{\partial \Psi}{\partial \varepsilon^p}$  ;  $\mathbf{A}_\alpha = \rho \frac{\partial \Psi}{\partial \alpha}$

## Free energy potential and state equations

### Linear elasticity

$$\blacktriangleright \rho\Psi(\boldsymbol{\varepsilon}, \boldsymbol{\alpha}, T) = \frac{1}{2}(\boldsymbol{\varepsilon} - \boldsymbol{\varepsilon}^p) : \mathbb{C} : (\boldsymbol{\varepsilon} - \boldsymbol{\varepsilon}^p)$$

$$\blacktriangleright \boldsymbol{\sigma}^r = \rho \frac{\partial \Psi}{\partial \boldsymbol{\varepsilon}} = \mathbb{C} : (\boldsymbol{\varepsilon} - \boldsymbol{\varepsilon}^p)$$

$$\blacktriangleright \mathbf{A}_{\boldsymbol{\varepsilon}^p} = \rho \frac{\partial \Psi}{\partial \boldsymbol{\varepsilon}^p} = -\mathbb{C} : (\boldsymbol{\varepsilon} - \boldsymbol{\varepsilon}^p) = -\boldsymbol{\sigma}^r$$



## Dissipation potential and evolution equations

### Dissipation potential

$$\blacktriangleright \varphi(q, \dot{\epsilon}, \dot{\epsilon}^P, \dot{\alpha}; \epsilon, \epsilon^P, \alpha, T)$$

### Thermal dissipation

$$\blacktriangleright -\frac{\nabla T}{T} = \frac{\partial \varphi(q, \dot{\epsilon}, \dot{\epsilon}^P, \dot{\alpha}; \epsilon, \epsilon^P, \alpha, T)}{\partial q}$$

### Evolution equations: subdifferential

$$\blacktriangleright (\boldsymbol{\sigma}^{ir}, \mathbf{X}_{\dot{\epsilon}^P}, \mathbf{X}_{\dot{\alpha}}) \in \partial_{(\dot{\epsilon}, \dot{\epsilon}^P, \dot{\alpha})} \varphi(q, \dot{\epsilon}, \dot{\epsilon}^P, \dot{\alpha}; \epsilon, \epsilon^P, \alpha, T)$$

## Intrinsic dissipation (1/2)

### Thermodynamics principles

- ▶  $d_1(\dot{\epsilon}, \dot{\epsilon}^P, \dot{\alpha}; \epsilon, \epsilon^P, \alpha) = \boldsymbol{\sigma} : \dot{\epsilon} - \rho \dot{\Psi} - \rho s \dot{T}$
- ▶  $d_1 = \boldsymbol{\sigma} : \dot{\epsilon} - \rho \frac{\partial \Psi}{\partial \boldsymbol{\epsilon}} \dot{\epsilon} - \rho \frac{\partial \Psi}{\partial \boldsymbol{\epsilon}^P} \dot{\epsilon}^P - \rho \frac{\partial \Psi}{\partial \boldsymbol{\alpha}} \dot{\alpha} - \rho \frac{\partial \Psi}{\partial T} \dot{T} - \rho s \dot{T}$
- ▶  $d_1 = (\boldsymbol{\sigma} - \boldsymbol{\sigma}^r) : \dot{\epsilon} - \mathbf{A}_{\epsilon^P} : \dot{\epsilon}^P - \mathbf{A}_{\alpha} : \dot{\alpha}$

### Intrinsic dissipation

- ▶  $d_1 = \boldsymbol{\sigma}^{ir} : \dot{\epsilon} + \mathbf{X}_{\dot{\epsilon}^P} : \dot{\epsilon}^P + \mathbf{X}_{\dot{\alpha}} : \dot{\alpha}$
- ▶  $\boldsymbol{\sigma}^{ir} = \boldsymbol{\sigma} - \boldsymbol{\sigma}^r ; \mathbf{X}_{\dot{\epsilon}^P} = -\mathbf{A}_{\epsilon^P} = \boldsymbol{\sigma}^r ; \mathbf{X}_{\dot{\alpha}} = -\mathbf{A}_{\alpha}$

## Intrinsic dissipation (2/2)

### Irreversibilities: $\alpha$

- ▶ deformation  $\varepsilon$  is not a dissipative variable: irreversible evolutions characterized by  $\varepsilon^P(\alpha)$
- ▶  $\varphi(q, \dot{\varepsilon}^P, \dot{\alpha}; \varepsilon, \varepsilon^P, \alpha, T)$
- ▶  $\sigma^{ir} = 0$

### Consequences

- ▶  $\sigma^r = \sigma$
- ▶  $d_1 = \sigma : \dot{\varepsilon}^P - \mathbf{A}_\alpha : \dot{\alpha} = \sigma : \dot{\varepsilon}^P - \dot{\Psi}_\alpha(\alpha)$

## Dissipation potential and yield function

### Some equivalences

$$\blacktriangleright (\mathbf{A}_{\varepsilon^P}, \mathbf{A}_\alpha) \in \partial_{(\dot{\varepsilon}^P, \dot{\alpha})} \varphi(\dot{\varepsilon}^P, \dot{\alpha}; \varepsilon, \varepsilon^P, \alpha)$$

$$\blacktriangleright (\dot{\varepsilon}^P, \dot{\alpha}) \in \partial_{(\mathbf{x}_{\dot{\varepsilon}^P}, \mathbf{x}_{\dot{\alpha}})} \varphi^*(\mathbf{A}_{\varepsilon^P}, \mathbf{A}_\alpha)$$

$$\text{with } \varphi^*(\mathbf{A}_{\varepsilon^P}, \mathbf{A}_\alpha, T) = \sup_{\dot{\varepsilon}^P, \dot{\alpha}} \{ -\mathbf{A}_{\varepsilon^P} : \dot{\varepsilon}^P - \mathbf{A}_\alpha : \dot{\alpha} - \varphi(\dot{\varepsilon}^P, \dot{\alpha}) \}$$

$\varphi^*(\mathbf{A}_{\varepsilon^P}, \mathbf{A}_\alpha, T)$  indicator function of a convex set:

$$\mathcal{C} = \{ (-\mathbf{A}_{\varepsilon^P}, -\mathbf{A}_\alpha) \text{ such as } f(\mathbf{A}_{\varepsilon^P}, \mathbf{A}_\alpha) \leq 0 \}$$

$$\blacktriangleright \dot{\varepsilon}^P = -\lambda \frac{\partial f(\mathbf{A}_{\varepsilon^P}, \mathbf{A}_\alpha)}{\partial \mathbf{A}_{\varepsilon^P}} ; \dot{\alpha} = -\lambda \frac{\partial f(\mathbf{A}_{\varepsilon^P}, \mathbf{A}_\alpha)}{\partial \mathbf{A}_\alpha}$$

with  $\lambda \geq 0, f \leq 0, \lambda f = 0$

## Illustration (1/2)

### Perfect plasticity

- ▶  $\rho\Psi(\boldsymbol{\varepsilon}, \boldsymbol{\alpha}, T) = \frac{1}{2}(\boldsymbol{\varepsilon} - \boldsymbol{\varepsilon}^p) : \mathbb{C} : (\boldsymbol{\varepsilon} - \boldsymbol{\varepsilon}^p)$
- ▶  $\varphi(\dot{\boldsymbol{\varepsilon}}^p) = \sigma_0 \|\dot{\boldsymbol{\varepsilon}}^p\| = \sigma_0 \sqrt{\dot{\boldsymbol{\varepsilon}}^p : \dot{\boldsymbol{\varepsilon}}^p}$
- ▶  $\varphi^*(\mathbf{A}_{\boldsymbol{\varepsilon}^p}) = \sup_{\dot{\boldsymbol{\varepsilon}}^p} \{-\mathbf{A}_{\boldsymbol{\varepsilon}^p} : \dot{\boldsymbol{\varepsilon}}^p - \varphi(\dot{\boldsymbol{\varepsilon}}^p)\} = \sup_{\dot{\boldsymbol{\varepsilon}}^p} \{\boldsymbol{\sigma} : \dot{\boldsymbol{\varepsilon}}^p - \varphi(\dot{\boldsymbol{\varepsilon}}^p)\} = \sup_{\|\dot{\boldsymbol{\varepsilon}}^p\|} \{\|\boldsymbol{\sigma}\| \cdot \|\dot{\boldsymbol{\varepsilon}}^p\| - \sigma_0 \|\dot{\boldsymbol{\varepsilon}}^p\|\} = \sup_{\|\dot{\boldsymbol{\varepsilon}}^p\|} \{(\|\boldsymbol{\sigma}\| - \sigma_0) \cdot \|\dot{\boldsymbol{\varepsilon}}^p\|\}$

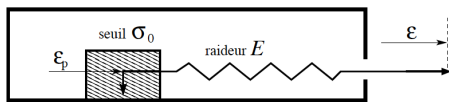

## Illustration (2/2)

$$\blacktriangleright \boldsymbol{\sigma} = \rho \frac{\partial \Psi}{\partial \boldsymbol{\varepsilon}} = \mathbb{C} : (\boldsymbol{\varepsilon} - \boldsymbol{\varepsilon}^P)$$

$$\blacktriangleright \mathbf{A}_{\boldsymbol{\varepsilon}^P} = \rho \frac{\partial \Psi}{\partial \boldsymbol{\varepsilon}^P} = -\boldsymbol{\sigma}$$

$$\blacktriangleright \boldsymbol{\sigma}^{irr} = \frac{\partial \varphi(\dot{\boldsymbol{\varepsilon}}^P)}{\partial \dot{\boldsymbol{\varepsilon}}} = 0$$

$$\blacktriangleright \text{if } \|\boldsymbol{\sigma}\| - \sigma_0 < 0 \text{ then } \dot{\boldsymbol{\varepsilon}}^P = 0$$

$$\blacktriangleright \text{if } \|\boldsymbol{\sigma}\| - \sigma_0 = 0 \text{ then}$$

$$\dot{\boldsymbol{\varepsilon}}^P = \lambda \frac{\boldsymbol{\sigma}}{\|\boldsymbol{\sigma}\|}, \lambda \geq 0$$

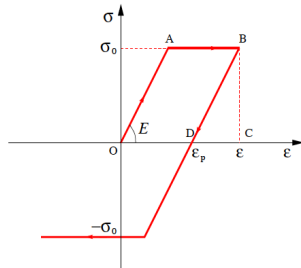

## Thermoplastic framework (1/2)

Internal energy rate:

$$\blacktriangleright \rho \dot{e} = \rho C \dot{T} + (\boldsymbol{\sigma} : \dot{\boldsymbol{\varepsilon}}^e + \mathbf{A}_\alpha : \dot{\boldsymbol{\alpha}}) - \left( T \frac{\partial \boldsymbol{\sigma}}{\partial T} : \dot{\boldsymbol{\varepsilon}}^e + T \frac{\partial \mathbf{A}_\alpha}{\partial T} : \dot{\boldsymbol{\alpha}} \right)$$

$$\blacktriangleright \rho \dot{e} = \rho C \dot{T} + (\dot{w}_e + \dot{w}_s) - \dot{w}_{thc}$$

Heat equation

$$\rho C \dot{T} + \text{div}(q) = r_e + \boldsymbol{\sigma} : \dot{\boldsymbol{\varepsilon}}^p - \mathbf{A}_\alpha : \dot{\boldsymbol{\alpha}} + \left( T \frac{\partial \boldsymbol{\sigma}}{\partial T} : \dot{\boldsymbol{\varepsilon}}^e + T \frac{\partial \mathbf{A}_\alpha}{\partial T} : \dot{\boldsymbol{\alpha}} \right)$$

## Thermoplastic framework (2/2)

### Energy balance in "classical" thermoplasticity

- ▶ heat sources  $\Phi$  determined from the heat equation (not detailed here)

- ▶ 
$$\Phi = \boldsymbol{\sigma} : \dot{\boldsymbol{\varepsilon}}^p - \mathbf{A}_\alpha : \dot{\boldsymbol{\alpha}} + T \frac{E_\alpha}{1 - 2\nu} \text{tr}(\dot{\boldsymbol{\varepsilon}}^e)$$

### Stored energy

- ▶ 
$$\dot{\Psi}_\alpha(\boldsymbol{\alpha}) = \boldsymbol{\sigma} : \dot{\boldsymbol{\varepsilon}}^p - d_1$$



## Non uniqueness of models: stored energy (1/3)

$$\blacktriangleright \rho\Psi(\boldsymbol{\varepsilon}, \boldsymbol{\varepsilon}^P, \boldsymbol{\alpha}) = \frac{1}{2}(\boldsymbol{\varepsilon} - \boldsymbol{\varepsilon}^P) : \mathbb{C} : (\boldsymbol{\varepsilon} - \boldsymbol{\varepsilon}^P) + \Psi_p(p) \text{ with}$$

$$p = \sqrt{\frac{2}{3}\dot{\boldsymbol{\varepsilon}}^P : \dot{\boldsymbol{\varepsilon}}^P}$$

$$\blacktriangleright \boldsymbol{\sigma} = \mathbb{C} : (\boldsymbol{\varepsilon} - \boldsymbol{\varepsilon}^P) ; \mathbf{A}_{\boldsymbol{\varepsilon}^P} = -\boldsymbol{\sigma} ; A_p = \frac{\partial \Psi_p(p)}{\partial p} = R(p)$$

$$\blacktriangleright f(\mathbf{A}_{\boldsymbol{\varepsilon}^P}, A_p) = \|\mathbf{A}_{\boldsymbol{\varepsilon}^P}\| - A_p - \sigma_0$$

## Non uniqueness of models: stored energy (2/3)

Example: isotropic hardening

$$\blacktriangleright \dot{\boldsymbol{\epsilon}}^P = -\lambda \frac{\partial f(\mathbf{A}_{\boldsymbol{\epsilon}^P}, A_p)}{\partial \mathbf{A}_{\boldsymbol{\epsilon}^P}} = \lambda \sqrt{\frac{3}{2}} \frac{\mathbf{s}}{\|\mathbf{s}\|} ; \dot{p} = -\lambda \frac{\partial f(\mathbf{A}_{\boldsymbol{\epsilon}^P}, A_p)}{\partial A_p} = \lambda$$

$$\blacktriangleright d_1 = \boldsymbol{\sigma} : \dot{\boldsymbol{\epsilon}}^P - A_p \dot{p} = \sigma_0 \dot{p}$$

Other model

$$\blacktriangleright R(p) \text{ and } \sigma_1$$

- ▶ **only dissipation and stored energy are concerned:** no influence on the mechanical model

## Non uniqueness of models: stored energy (3/3)

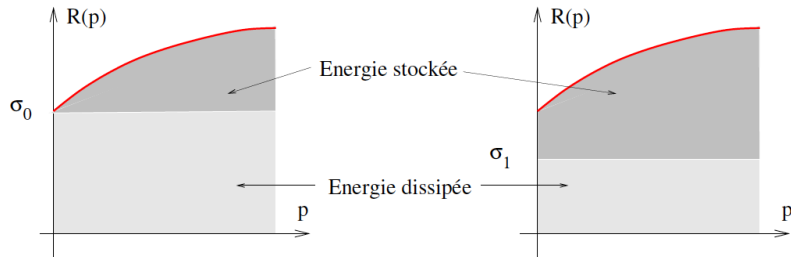

[Suquet, Rupture et Plasticité, Ecole Polytechnique, 2004]

## Some experimental thermomechanical evidences

## A simple tensile test: temperature evolutions

### 3 thermal phases

1. linear drop: *elasticity*
2. inflection: *micro dissipation*
3. increase: *global dissipation* [Lee, J. Mat. Sci., 1991]

### Macroscopic results

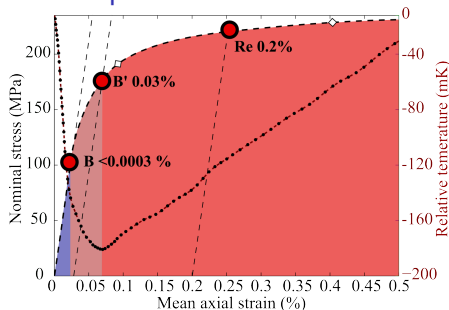

Identification of a macroscopic yield of dissipation  $\rightarrow \epsilon^p < 10^{-4}\%$  by means of Maximum Likelihood method and deviation from thermal linearity

[Seghir et al., Exp. Mech., 2014]

# First energy balances: calorimetry

$\beta$  ratio

$$\beta = \frac{\dot{\Psi}_\alpha(\alpha)}{\sigma : \dot{\epsilon}^p}$$

$$\beta = 1 - \frac{d_1}{\sigma : \dot{\epsilon}^p} \subset [5, 20] \%$$

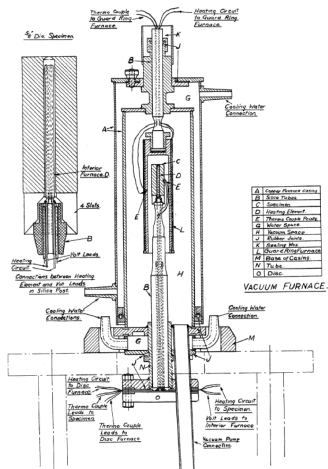
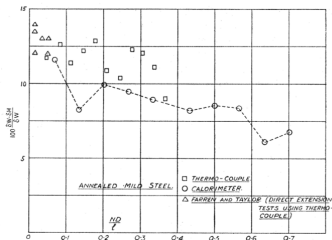

FIG. 4



[Quinney and Taylor, Proc. Roy. Soc., 1937]

## First energy balances: calorimetry

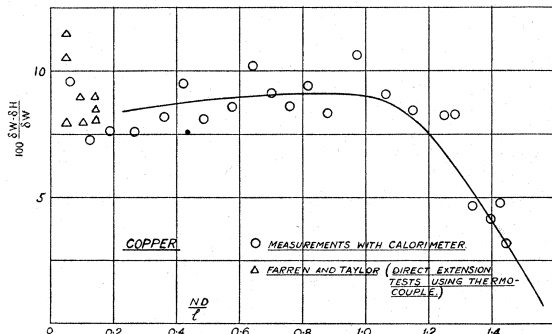

FIG. 6.—Percentage of work done which remains latent in specimen subjected to plastic twisting.

[Quinney and Taylor, Proc. Roy. Soc., 1934, 1937]

## GSM and infrared thermography

### Tension test on Duralumin

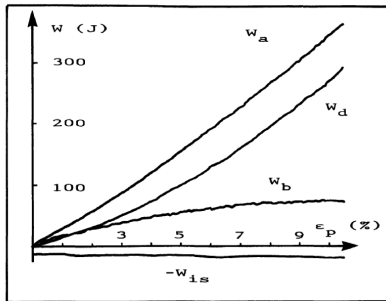

Fig. 6. — Bilan énergétique dans le cas d'un duralumin ; limitation de l'énergie bloquée.

[Energy balance in case of duralumin ; stored energy limitation.]

[Chrysochoos et al., Rev. Phys. Appl., 1989]

- Classical constitutive laws are not "thermomechanically admissible", i.e. respect energy balance



## Towards the microstructure

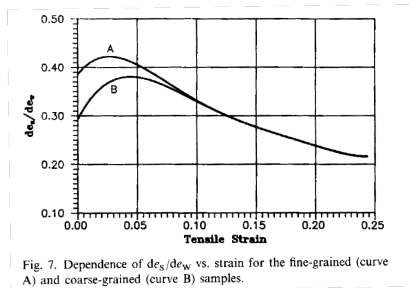

Fig. 7. Dependence of  $d\epsilon_s/d\epsilon_w$  vs. strain for the fine-grained (curve A) and coarse-grained (curve B) samples.

$\beta$  depends on the microstructure  
(grain size ...)

[Oliferuk et al., Mat. Sci. Eng. A, 1995]

## Energy balance in a polycrystal

1,776 grains on surface

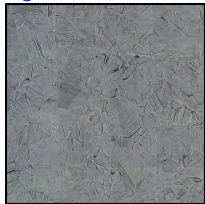

surface microstructure (5x5mm<sup>2</sup>)

Macroscopic energy balance

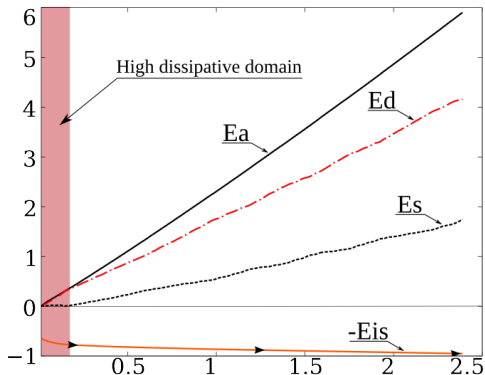

## Towards polycrystals

## A simple model: the three-bar truss

### Stored energy in residual stresses

$$\blacktriangleright W^r = \int_V \frac{1}{2} \boldsymbol{\sigma}^r : \mathbb{C}^{-1} : \boldsymbol{\sigma}^r dV$$

$$\blacktriangleright W^r = \frac{Al\sigma_0^2}{E} \frac{\sin^2 \alpha \cos \alpha}{1 + 2 \cos^3 \alpha}$$

▶  $W^r$  equal to shaded area

▶ extension to polycrystals:  
shaded area is an  
approximation

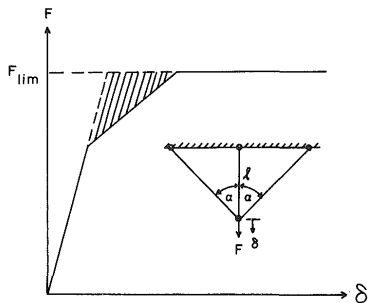

[Leckie et al., J. Eng. Mat. tech., 1990]

## Extension to polycrystals

### Stored energy in polycrystals

1.  $E_{sh}$  → stored energy due to the hardening process
2.  $E_{sr}$  → stored elastic energy due to internal stresses field

### Principle: elastic perfectly plastic bi-crystal

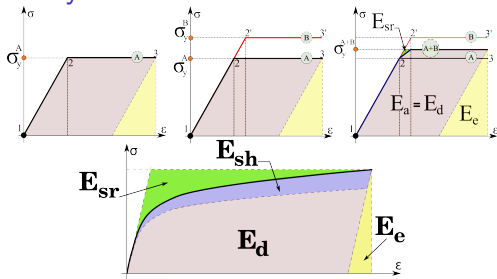

Polycrystals with local hardening

## Extension to polycrystals

### Macroscopic measurements

1.  $E_d \rightarrow$  heat equation
2.  $E_s = E_a - E_d$
3.  $E_{sr} \rightarrow$  stress-strain curve
4.  $E_{sh} = E_s - E_{sr}$

### Principle: elastic perfectly plastic bi-crystal

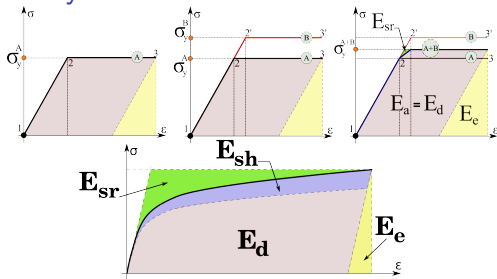

Polycrystals with local hardening

## Stored energies

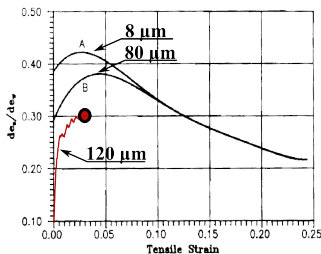
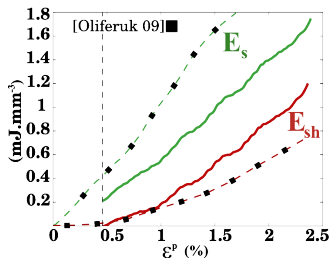

[Oliferuk et al., Eur. J. Mech. A/sol., 2009] & [Oliferuk et al., Mat. Sci. Eng. A, 1994]

► confirmation: grain size  $\nearrow \beta^* \searrow$  (early plasticity)

## Grain size influence

- ▶ observation at 2.5% of plastic strain:
  - ▶ grain size ( $\approx 20\mu m$ ): storage  $\rightarrow$  "internal stresses" 77%  $\rightarrow$  "hardening" 23%
  - ▶ grain size ( $\approx 120\mu m$ ): storage  $\rightarrow$  "internal stresses" 31%  $\rightarrow$  "hardening" 69%



## Stored energy and dislocations

$$E_s = \frac{m^2 \alpha_s}{\alpha^2 \mu} \Sigma^2 \approx 0.8 \times 10^{-4} \Sigma^2$$

[Schmid and Boas, 1950] [Bailey and Hirsch, 1960]

[Williams, 1964] [Bever et al., 1973]

- ▶  $m$ : Schmid factor
- ▶  $\alpha$ : a constant  $\approx 0.3$
- ▶  $\alpha_s$ : a constant  
 $\in [1.8 - 2.1]$
- ▶  $\mu$ : the shear modulus

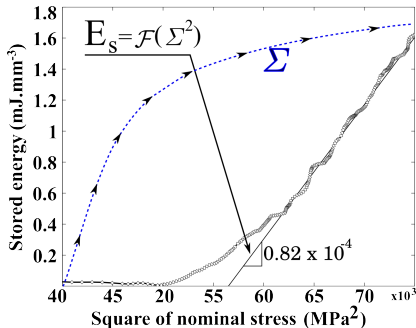

## Grains and/or crystals

## A simple monotonic tensile test

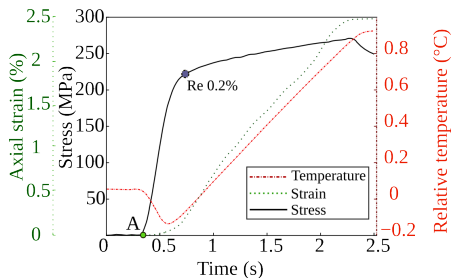

Tensile test at  $5 \cdot 10^{-3} s^{-1}$

1,776 grains on surface

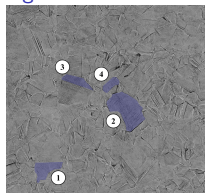

surface microstructure ( $5 \times 5 \text{mm}^2$ )

## From polycrystal to grains

### Observations

2 distinct activated slip systems

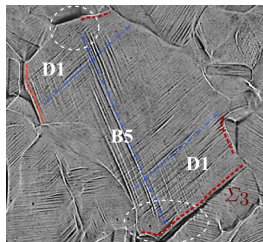

### Crystallographic point of view

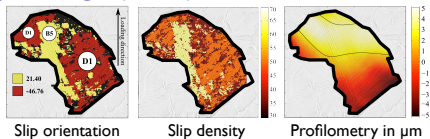

- ▶ maximum Schmid factor principle: system  $D_1$  (0.339) and  $B_5$  (0.296)
- ▶ deformation scenario:  $D_1 \rightarrow B_5$

## Deformation scenario

- ▶ kinematic  
→  $\tau_c = 35$  MPa
- ▶  $D_1$  dissipates early
- ▶ temperature  
→  $\tau_c = 25$  MPa

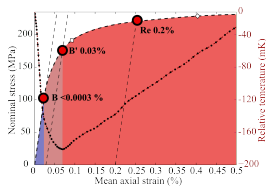

## Thermal point of view: local temperature inflection

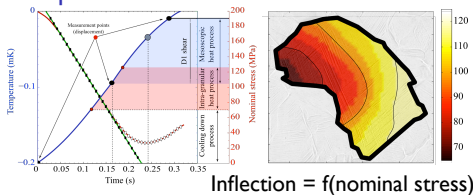

- ▶ intragranular thermal deviation from linearity at 78 MPa

## Deformation scenario

- ▶ 2 distinct plastic domains  $D_1 \rightarrow B_5$
- ▶ kinematic  
 $\rightarrow \tau_c = 35 \text{ MPa}$
- ▶ temperature  
 $\rightarrow \tau_c = 25 \text{ MPa}$
- ▶ generalization:
  - ▶ grain diameter  
 $> 104 \mu\text{m}$
  - ▶ early inflection  
 (165 grains)

## Statistical point of view: 165 grains

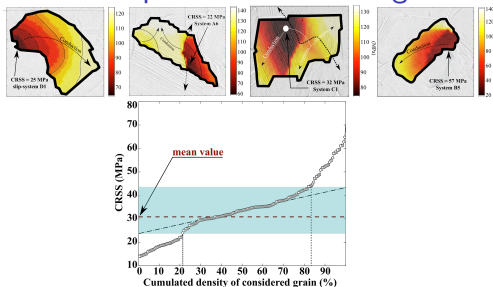

## Conclusion

**CRSS = 31 MPa  $\pm$  7 MPa within the polycrystal**

**in line with [Feugas, Adv. Eng. Mater., 2009] within AISI 316L single crystal**

Thank you for your attention

[eric.charkaluk@ec-lille.fr](mailto:eric.charkaluk@ec-lille.fr)