



HAL
open science

From IR thermal images to heat source assessments

André Chrysochoos, Xavier Balandraud, Bertrand Wattrisse

► **To cite this version:**

André Chrysochoos, Xavier Balandraud, Bertrand Wattrisse. From IR thermal images to heat source assessments. Doctoral. Summer School Identification procedures using full-field measurements, applications in mechanics of materials and structures, Montpellier, France. 2013. cel-02057614

HAL Id: cel-02057614

<https://hal.science/cel-02057614>

Submitted on 5 Mar 2019

HAL is a multi-disciplinary open access archive for the deposit and dissemination of scientific research documents, whether they are published or not. The documents may come from teaching and research institutions in France or abroad, or from public or private research centers.

L'archive ouverte pluridisciplinaire **HAL**, est destinée au dépôt et à la diffusion de documents scientifiques de niveau recherche, publiés ou non, émanant des établissements d'enseignement et de recherche français ou étrangers, des laboratoires publics ou privés.



CNRS Summer School

*“Identification Procedures using Full-Field Measurements
Applications in Mechanics of Materials and Structures”*

May 21th – May 25th 2013 – Montpellier (France)



From IR thermal images to heat source assessments

Part 1

Measurements of temperature fields



A. Chrysochoos⁽¹⁾, X. Balandraud⁽²⁾, B. Wattrisse⁽¹⁾



⁽¹⁾ Mechanics and Civil Engineering Laboratory, UMR CNRS 5508, Montpellier

⁽²⁾ Pascal Institute, UMR CNRS 6602, Clermont-Ferrand

What are the necessary investments?

Part 1

- 1 - Thermal sciences and heat diffusion..... 9 slides
- 2 - Thermal sensors..... 3 slides
- 3 - Quantitative Infrared thermography 3 slides

Part 2

- 4 - Theoretical framework (CM + TIP)11 slides
- 5 - Image processing and heat source assessment11 slides
- 6 - Illustrative examples 6 slides

Part 3

- 7 - Tutorial session

Notion of temperature

temperature T :

- intensive physical quantity objectively characterizing the subjective sensation of “coldness” or “hotness” in contact of a body
- several definitions:
 - “macroscopic”: following the 2nd principle of Thermodynamics (see IHS-1)
 - ☒ non-negative scalar such as: “ $s \geq \delta Q/T$ ”
 - “thermo-statistics”: increasing function of the kinetic energy of the system
 - ...

Heat equation

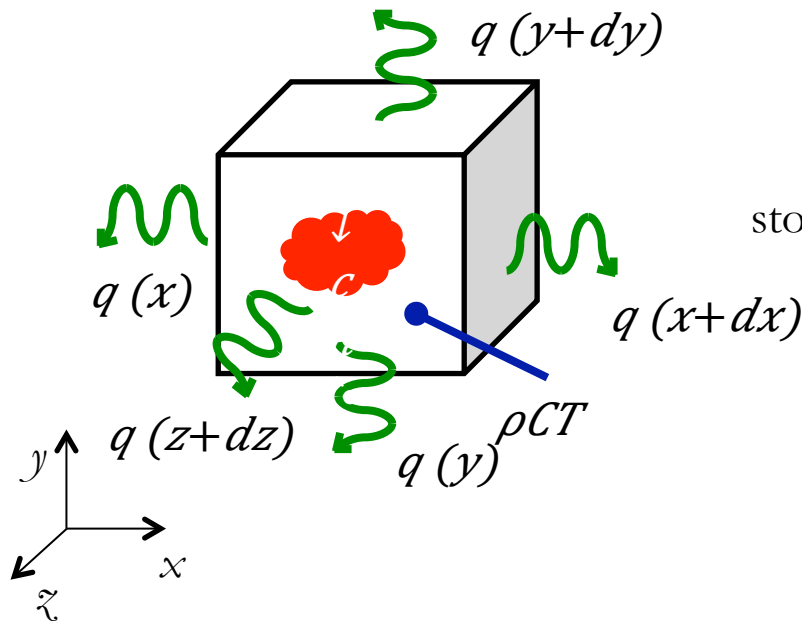

volume heat source : $w \downarrow ch \uparrow \bullet$

stored/released heat:
 $\rho C T$

exchanged heat:
 $\text{div}(q)$

hyp.: conduction follows Fourier's law

$$q = -k \text{ grad}(T)$$

\boxtimes heat diffusion equation (see IHD -1):
 $\rho C T - k \text{ grad}(T) = w \downarrow ch \uparrow \bullet$

regularizing effect of heat diffusion \boxtimes

inverse estimation of the heat sources from the temperature : **very instable !**

cf. IHS-PS1 and the (old) following example ...

Example of heat diffusion

1990, 20 years ago !!

Agema 880 camera,
digitized video signal
2 Hz

IBM 80286

Dos 4.1 , HD 60 Mo
(NETD : 200 mK)

temperatures maps :

1 « hot spot »

$$q = 3.5 \text{ } ^\circ\text{C}$$

heat sources map :

2 wires heated via Joule effect

$$\text{power} : 3 \cdot 10^{-2} \text{ W}$$

screen capture, Turbo Pascal programming

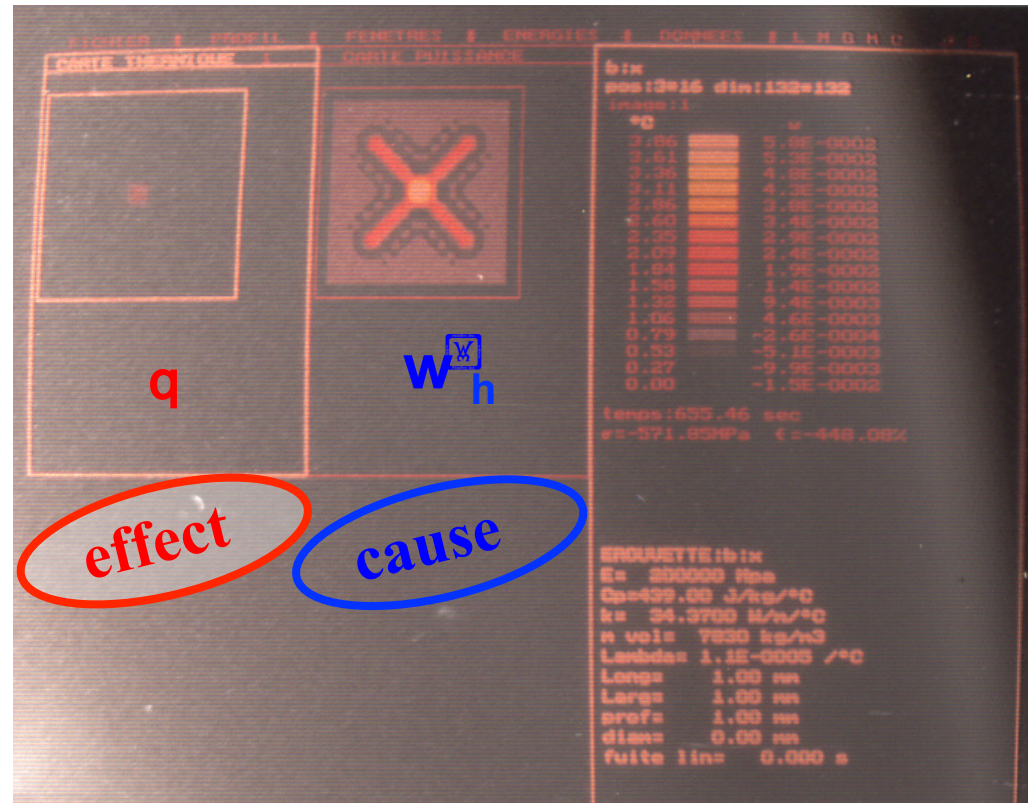

Example of heat diffusion

- steel plate : 4 spots :
active before t_0 , then deactivated

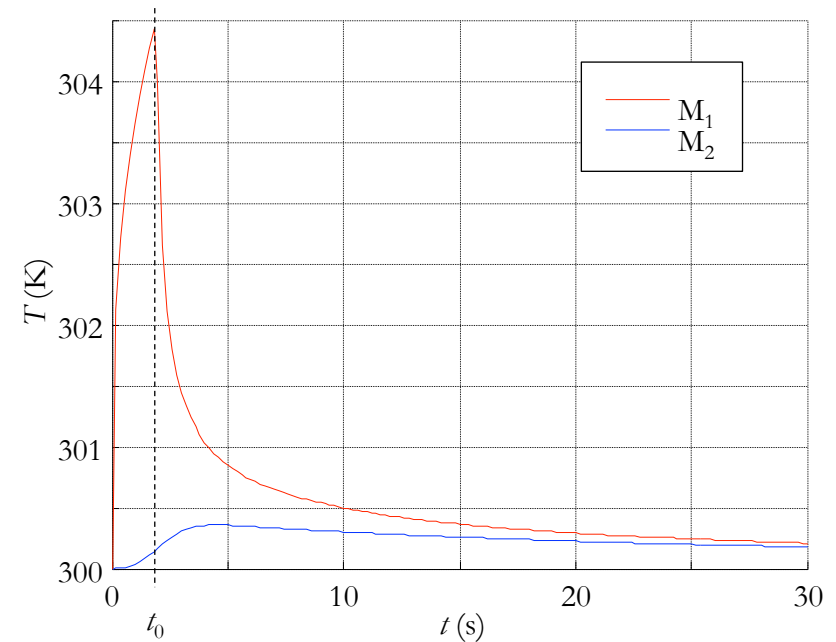
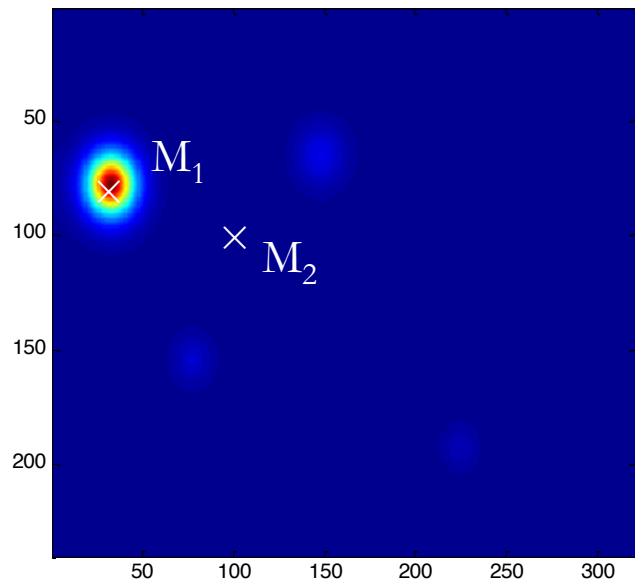

- temperature variations can be observed (somewhere) ...
... while no heat sources are active !
- no temperature variations can be observed ...
... while heat sources are active (somewhere else) !

Measurement of temperatures

measurement chain:

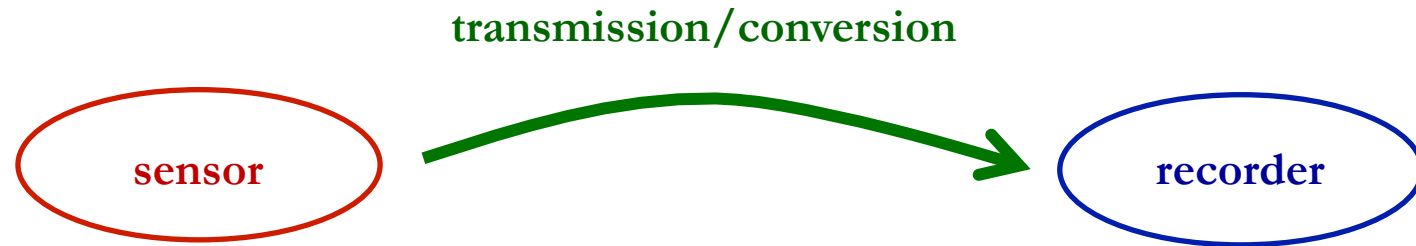

common types of sensors:

- thermo-mechanic effect: dilatation of a gas/liquid/solid
- thermo-electric effect: thermocouples
- radiation: pyrometers, bolometers, (*cf.* IR cameras)
- electric resistance: thermistances
- ...

Principle

thermocouples are made of two different metals M_A and M_B , connected by two junctions:

- a reference “cold” junction **R**
- a measuring “hot” junction **M**

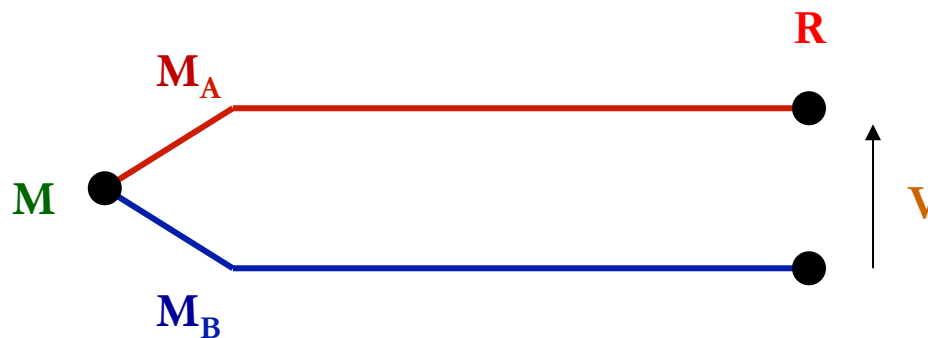

 voltage difference (**V**) generation through the thermo-electric Thomson effect

Characteristics

- ≠ applications \square ≠types of thermocouples:
K, T, J, N, E, R, S, B, G, C, D
- most common thermocouples:
 - type K:** NiCr (Chromel) / NiAl (Alumel).
 - operating temperature T_{ext} \square [90K, 1000K]
 - accuracy: \square 1.5K (Class 1), \square 2.5K (for Class 2)
- necessity to protect the thermocouples:
 - \square electrical insulation/thermal protection
 - PTFE: T_{ext} \square [200K, 520K]
 - silk glass: $T_{\text{ext}} < 720\text{K}$, ...

Choice criteria

Advantages:

- low cost (a few € to a few hundred €).
- good accuracy: $\pm 1.5\text{K}$ (Class 1), $\pm 2.5\text{K}$ (Class 2)
- good response time (depending on the thermocouple \pm):
time constant $t_{63\%}$ \pm [0.05 s, 5s], even 0.007s (\pm \pm 0.25mm)
- wide range of temperature (depending on the type)

Drawbacks:

- contact measurement
- punctual measurement \pm fields?
... collections of sensors !

Electromagnetic radiations

any body at a temperature $> 0 \text{ K}$ emits a thermal radiation

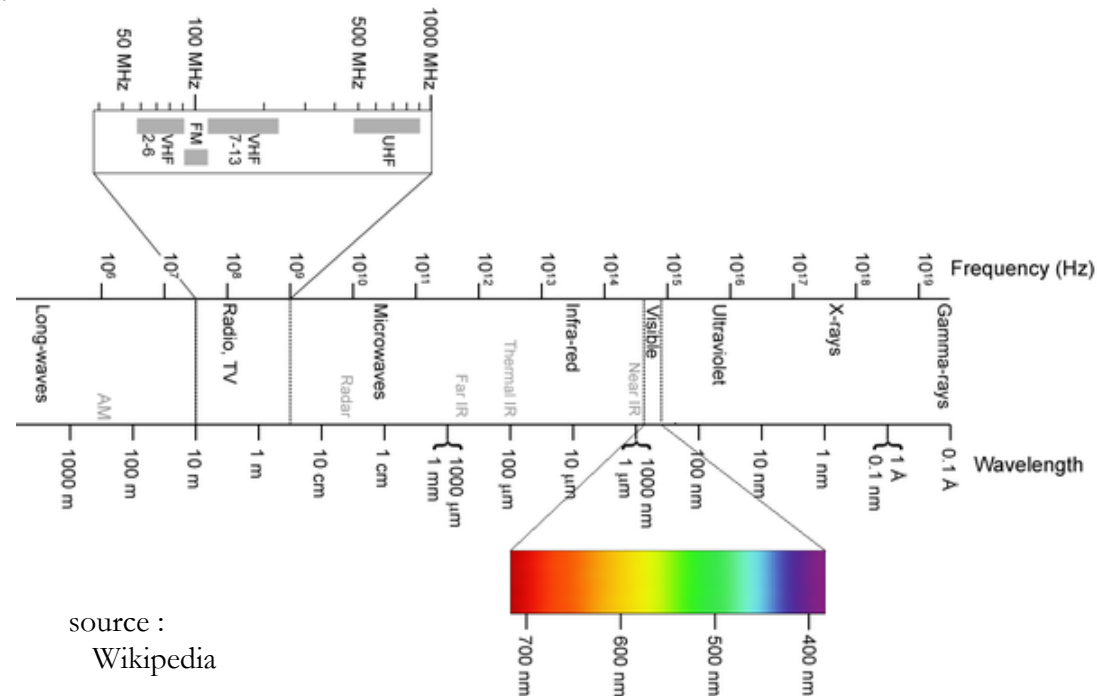

source :
Wikipedia

- the infrared radiation occupies only one part of the thermal radiation spectrum (IR-visible-UV : cooler \boxed{W} warmer)
- the spectral band covered by the infra-red thermography is narrower: $[2\mu\text{m}, 15 \mu\text{m}]$

Principles of IR radiometry

Motives : surface temperature measurements
 (... for heat sources identification, see IHS-1)

radiating target

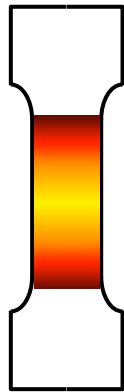

atmosphere

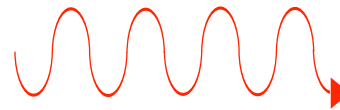

I.R. radiation

IR detector

(single, linear, matrix sensor)

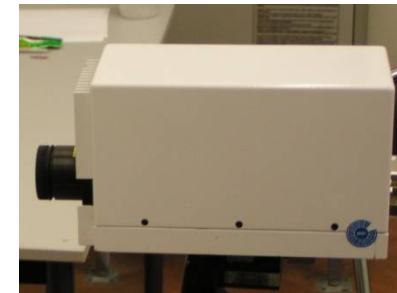

$D_1=3-5 \mu\text{m}$, $4-8 \mu\text{m}$, $8-12 \mu\text{m}$, ...

Medium : pyrometer, IR focal plane array camera

detector : produces an electrical signal (V) related to the radiated power (W)

exitance : overall flux emitted by the target per unit surface ($\text{W}\cdot\text{m}^{-2}$)

... for a given bandwidth

$$R = \int_{\Delta\lambda} \frac{\partial R(\lambda, T)}{\partial \lambda} d\lambda$$

spectral exitance
varies with T !

A simple common situation ...

- **target = « black body »** : able to absorb every incident radiation, $\tau_j = 1$, $\tau = 1$, $\tau = 1$,
(*i.e.* no reflexion, no transmission: see slide 14)

almost totally
closed cavity

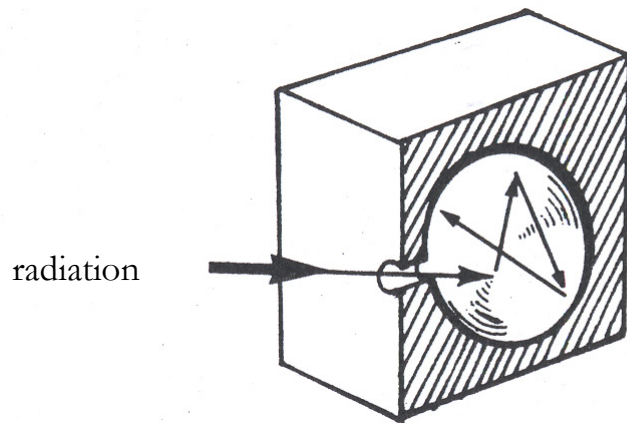

« perfectly » absorbing
coating (*)

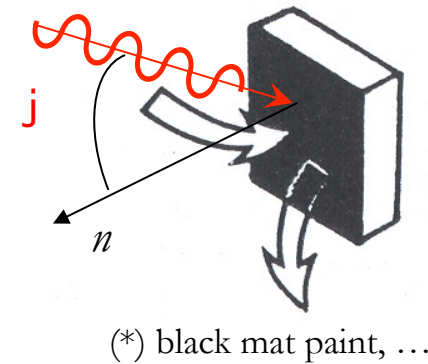

[G. Gausorgues, Infrared Thermography, 94]

- **atmosphere = small distance, dry air** (transparent to IR radiations)
 - $\tau = 1$ perfect transmission
(*i.e.* every radiation emitted by the target is received on the detector)

Radiation laws

for a black body ...

- Planck's law

$$\frac{\partial R_{cn}(\lambda, T)}{\partial \lambda} = \frac{2\pi hc^2 \lambda^{-5}}{\exp\left(\frac{hc}{\lambda kT}\right) - 1}$$

R : exitance, $W.m^{-2}$

h : Planck, $6,66.10^{34}$ J.s

k : Boltzmann, $1,38.10^{23}$ J.K⁻¹

c : light celerity, 3.10^8 m.s⁻¹

T : temperature, K

- Stefan-Boltzmann's law

$$R_{cn} = \sigma_s T^4$$

σ_s : Stephan's constant

$$\sigma_s = \frac{2\pi^5 k^4}{15c^2 h^3} = 5,67 10^{-8} W.m^{-2}.K^{-4}$$

[G. Gaussorgues]

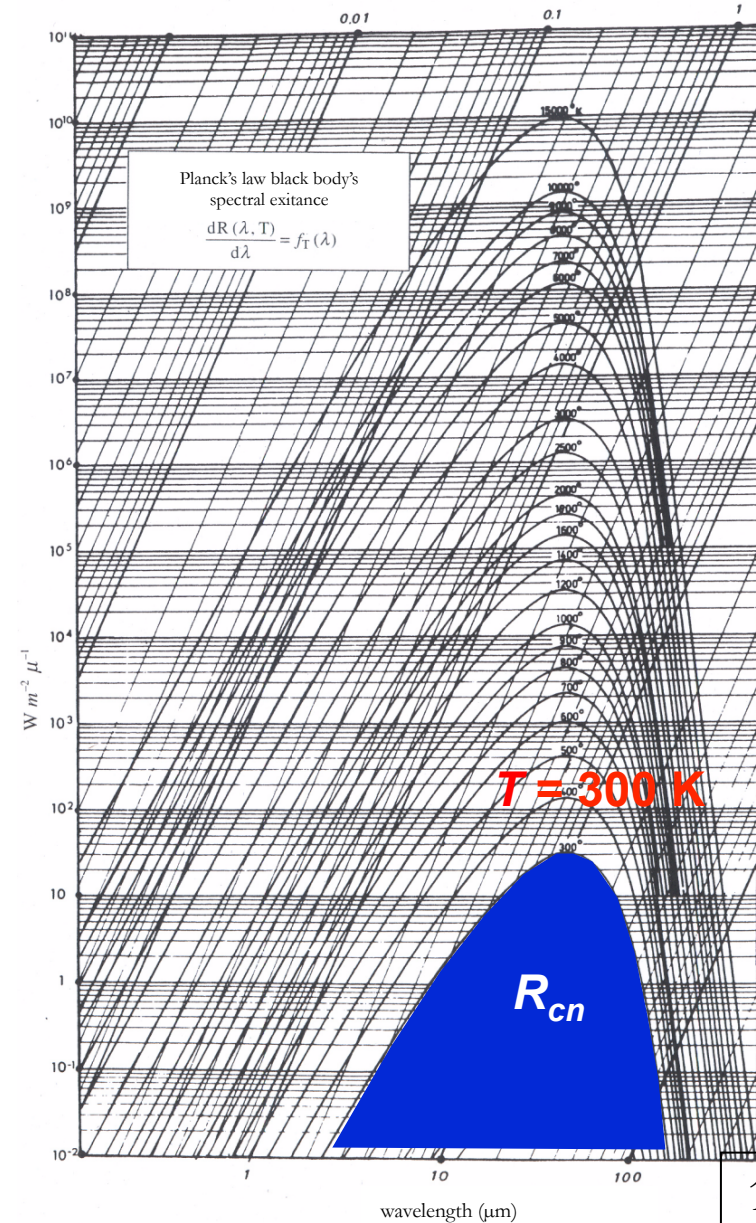

Remarks on Planck's law

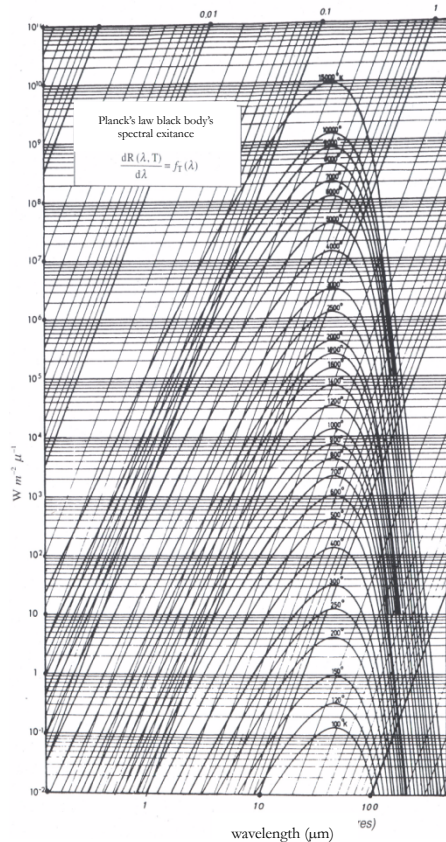

- the emission spectrum of a black body is continuous
- if $T < 2300\text{K}$, the totality of emitted energy is in the infrared spectrum
- at fixed λ , the exitance increases if T increases
- when T increases the maximum of energy moves to the weak wavelength (*cf.* Wien's law)
 this displacement explains the change of color during the heating of a body.

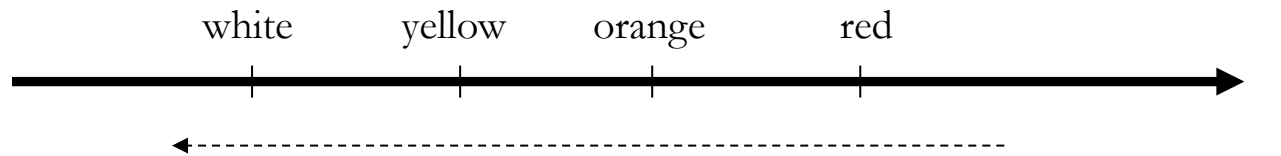

displacement of $\max(R)$ when T increases

Target and environment

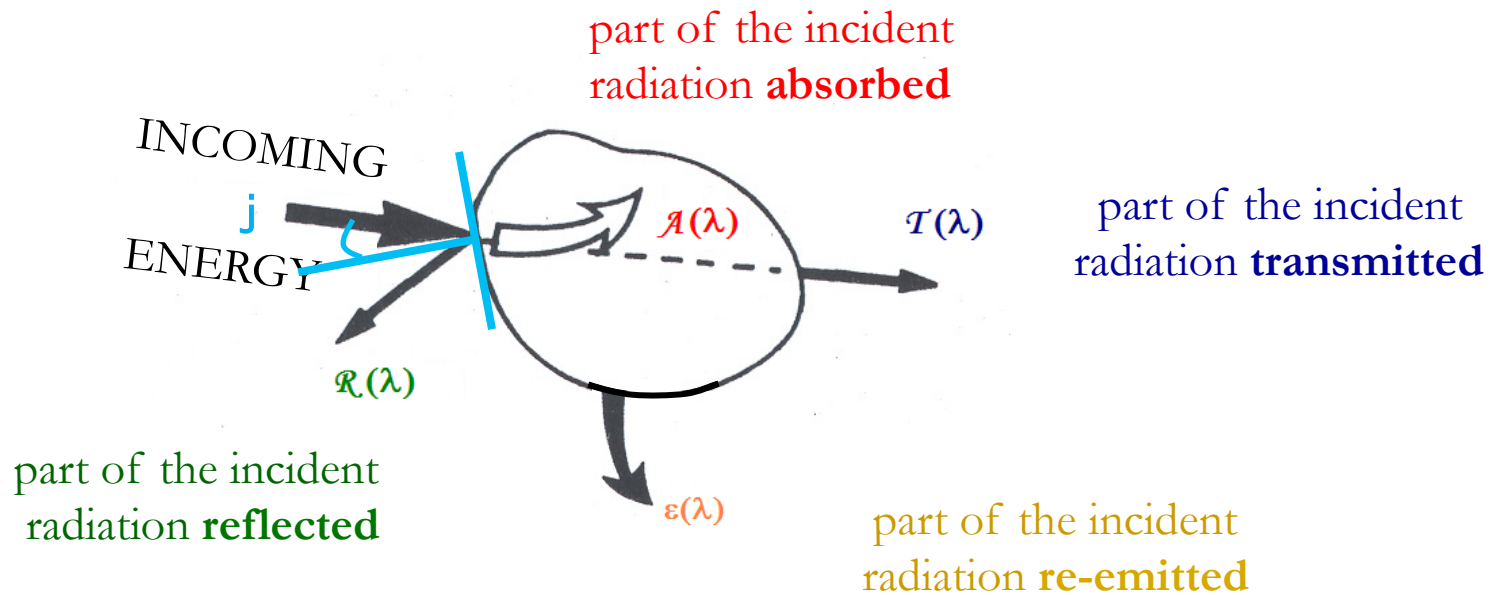

\mathcal{A} , \mathcal{R} and \mathcal{T} depend on l , but also on j , T , surface roughness, ...

- energy conservation:

$$\mathcal{A}(l) + \mathcal{R}(l) + \mathcal{T}(l) = 1$$

- « thermal » equilibrium:

$$\mathcal{A}(l) = \epsilon(l)$$

emissivity

Classification of several bodies

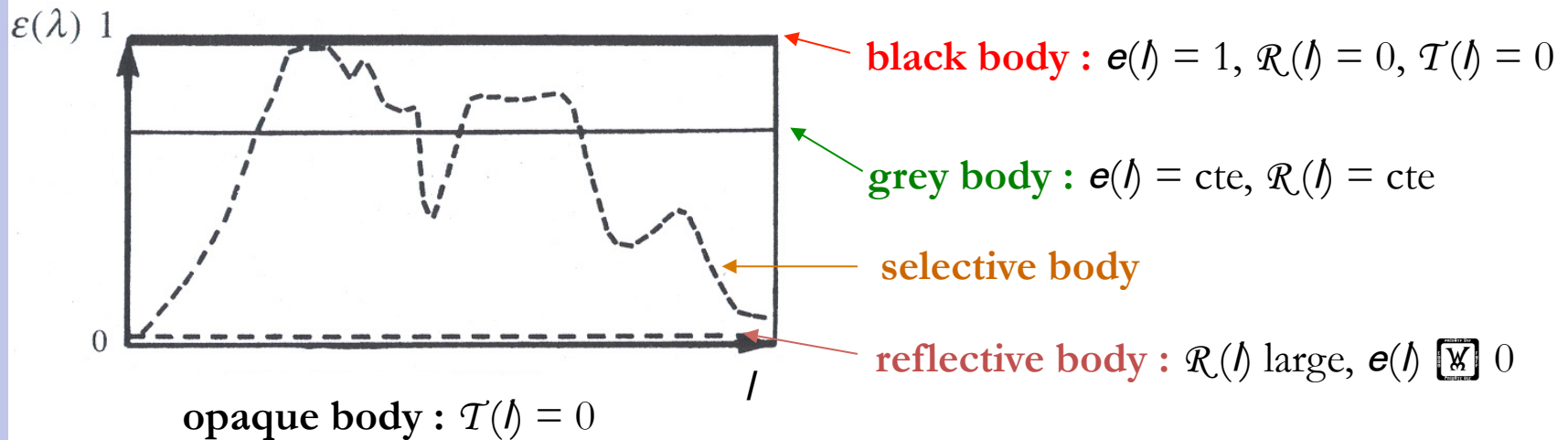

(reflection and absorption are surface phenomena
occur within a limited, less than $1\mu\text{m}$, depth under the surface)

N.B. :

- no other surface can emit more energy than a blackbody, for given (T, λ)
- the emission of a blackbody is isotropic

$$\frac{\partial R}{\partial \lambda}(\lambda, \varphi, T) = \epsilon(\lambda, \varphi) \frac{\partial R_{cn}}{\partial \lambda}(\lambda, T)$$

$$R_{\Delta\lambda}(T, \varphi) = \int_{\Delta\lambda} \epsilon(\lambda, \varphi) \frac{\partial R_{cn}}{\partial \lambda}(\lambda, T) d\lambda$$

Radiations' incidence angle

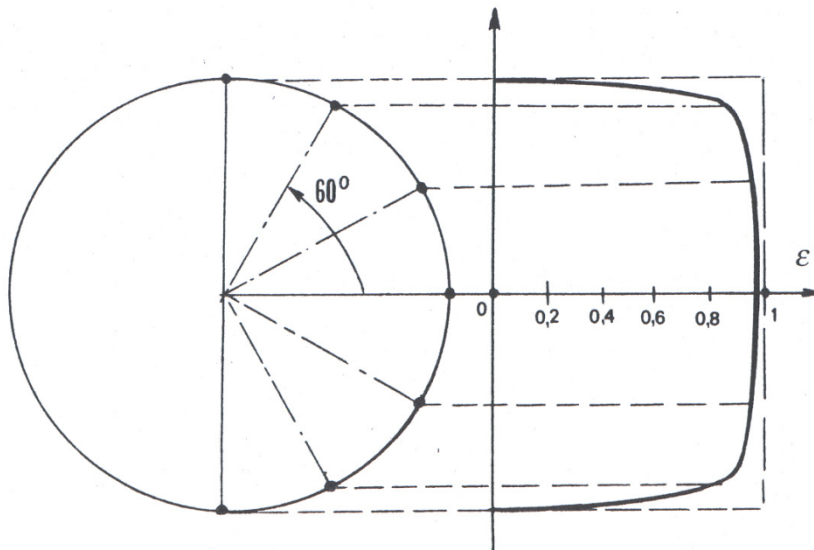

dielectric sphere
emissivity

e : emissivity

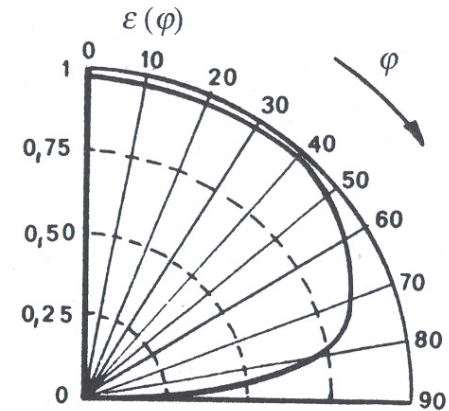

j : observation angle

water emissivity for $l=10 \mu\text{m}$

- up to $j = 45-50$ degrees, lambertian bodies ... ☒☒/☒☒ ☒
- small risks : flat samples ☒ optical axis of the camera
- + grey body with a large emissivity (paint, ...)
- + small temperature variations

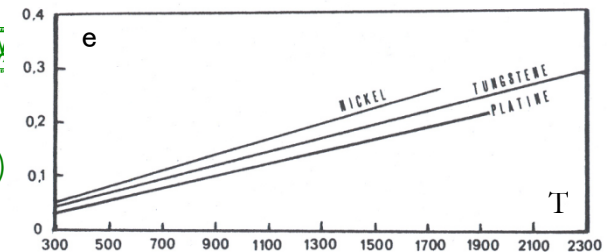

$$R_{\Delta\lambda}(T) \approx \varepsilon R_{cn_{\Delta\lambda}}(T)$$

Atmospheric transmittance (I)

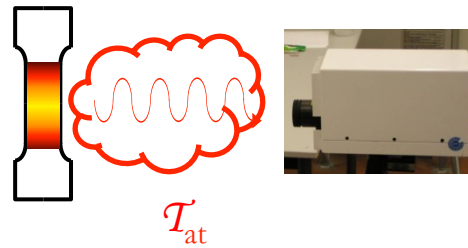

T_{at} : atmospheric transmittance
for the standard atmosphere
(thickness of 30 m)

(source: Pajani D. ADD Ed.)

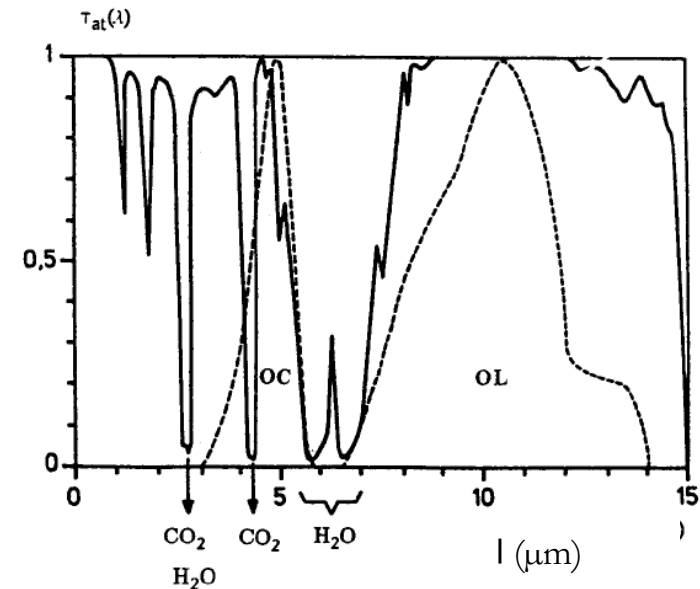

☒ **forbidden wavelength bands** (in μm):

[2.5,2.8] **absorption** of radiation by **CO₂** and **H₂O**

[4.2,4.4] **absorption** of radiation by **CO₂**

[5.5,7.3] **absorption** of radiation by **H₂O**

☒ **two common bands** used for infrared detectors:

SW: Short Wave [3 μm , 5 μm]

LW: Long Wave [8 μm , 12 μm]

Atmospheric transmittance (II)

Atmospheric transmittance for the standard atmosphere (30 ppm of CO₂ and 50% of humidity)
(source: Pajani D. ADD Ed.)

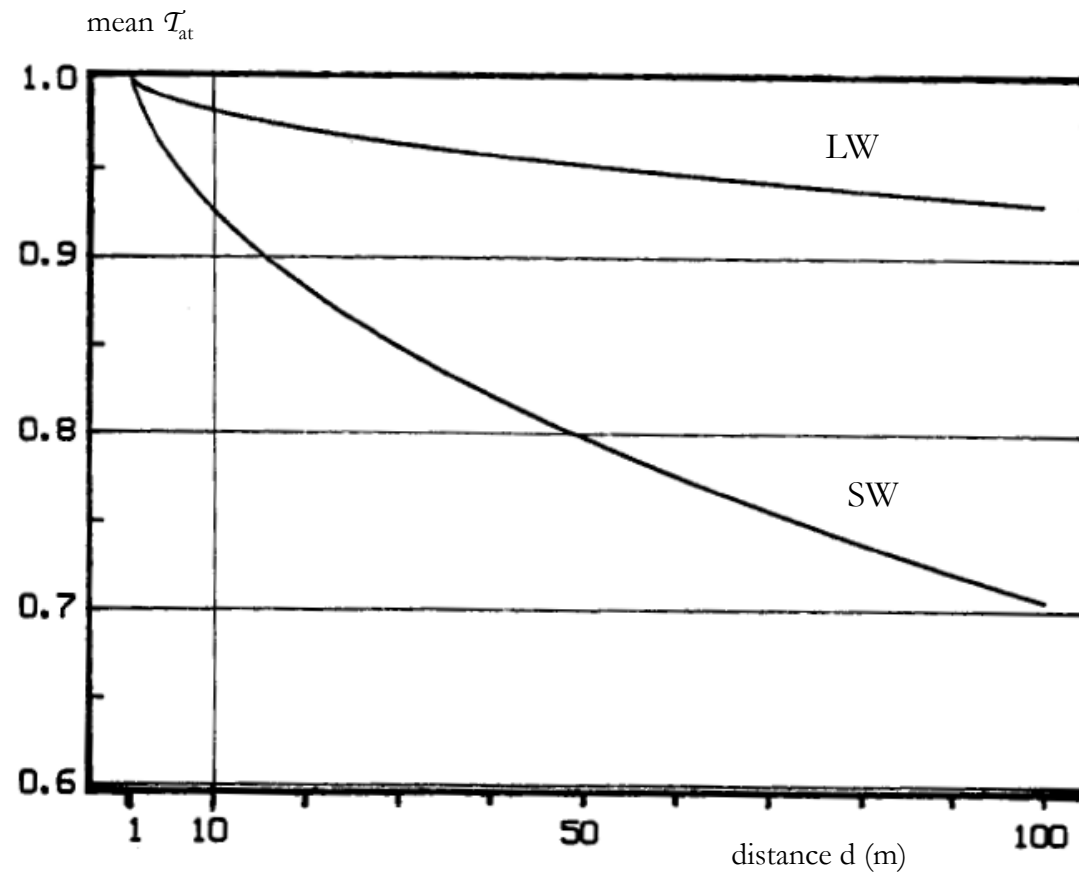

Measurement by IR radiometry

- advantages:
 - no contact
 - response time ($\approx 1 \mu\text{s}$)
 - temperature fields (lines, arrays) at each recorded time
 - good accuracy: $\approx 2\text{K}$ or 2%
 - good spatial resolution ($\approx 10 \mu\text{m}$)
- drawbacks:
 - cost: from 5k€ to 100k€ ...
 - calibration
- many products with many technologies:
 - thermo-detectors: bolometers, ...
 - photo-detectors: semi-conductors (In-Sb, ...)
- difference between **imagery** and **measure**

IR camera description



- image : 320 \times 240 pixels
- coding : 14 bits
- frame rate : 250 im./s
- spatial resolution : « \pm » 100 μm /pix.
- NETD : 20 mK at room temp.

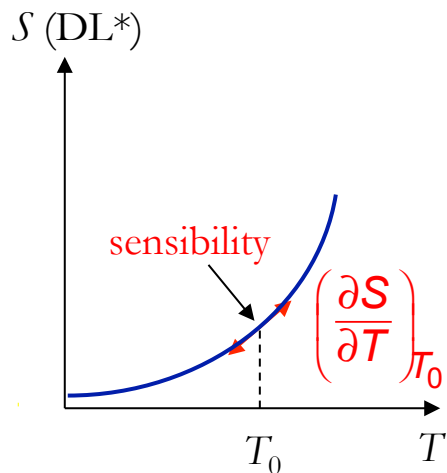
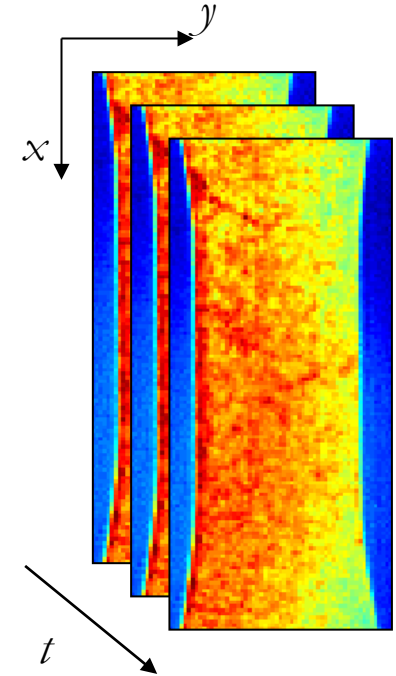

(*) DL: digital level

NETD : (noise equivalent temperature difference)
 temperature difference equivalent to the noise root mean square
 value measured on the thermo-signal

$$\text{NETD}(T_0) = \frac{\text{std}(S)}{\left(\frac{\partial S}{\partial T}\right)_{T_0}}$$

IR camera calibration (I) : NUC

manufacturer procedure

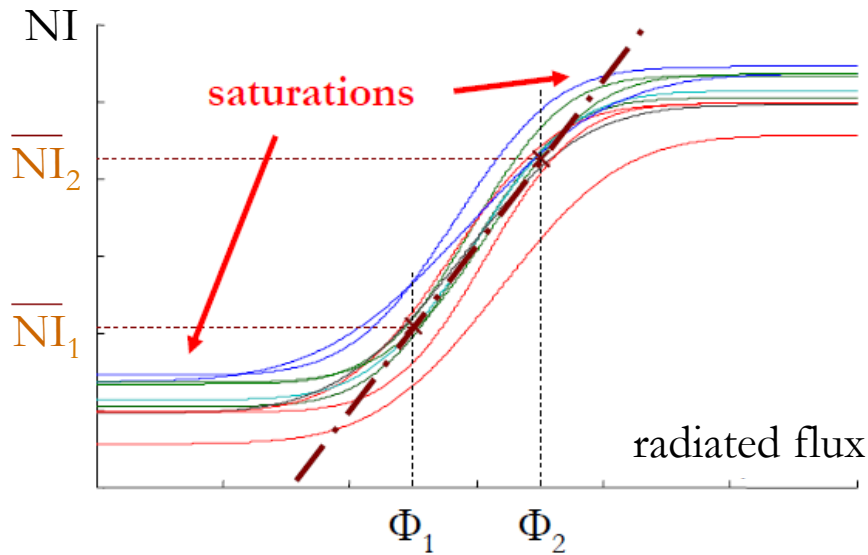
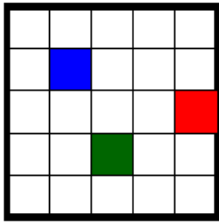

- 2 uniform thermal scenes (F_1 and F_2)
white paper sheet (F_1) + hand (F_2) ...
- DF 5 50 % of the sensors' range (linear part)
- NUC and BPR operations

- determination of **one set** of calibration parameters (a_k):

$$T = \sum_{k=0}^{\infty} a_k DL^k$$

principle of NUC :

find the gains (a_{ij}) and the offset (b_{ij}) of each pixel in order to bring the linear part of the responses on the same curve :

$$\tilde{DL} = \alpha_{ij} DL + \beta_{ij}$$

IR camera calibration (II) : NUC

limits of the NUC

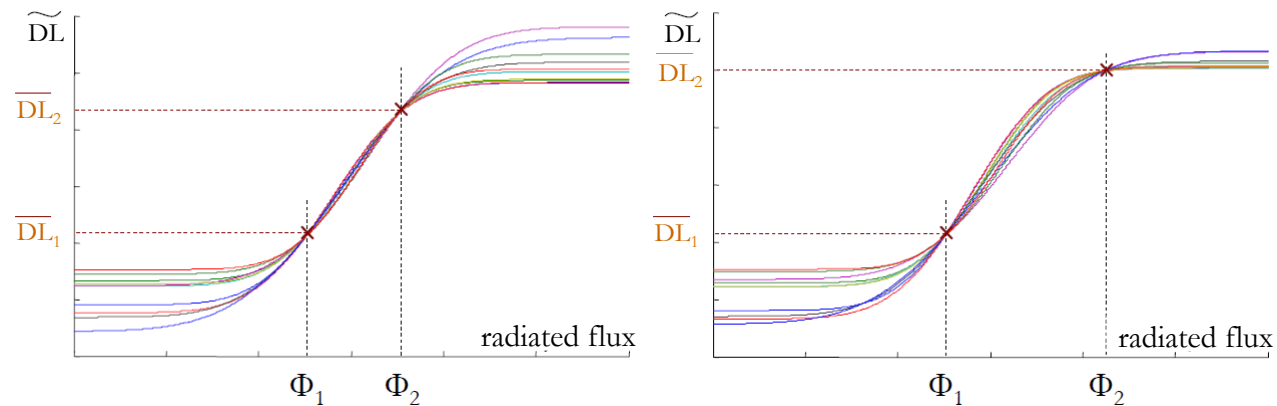

- hypothesis of the linear response of the sensor
- non intrinsic definition of (a_{ij}) and (b_{ij})

IR camera calibration (III) : BPR

principle of BPR :

- (i) detection of « dead » or « abnormal » pixels
- (ii) possible replacement of the « defective » pixels temperature

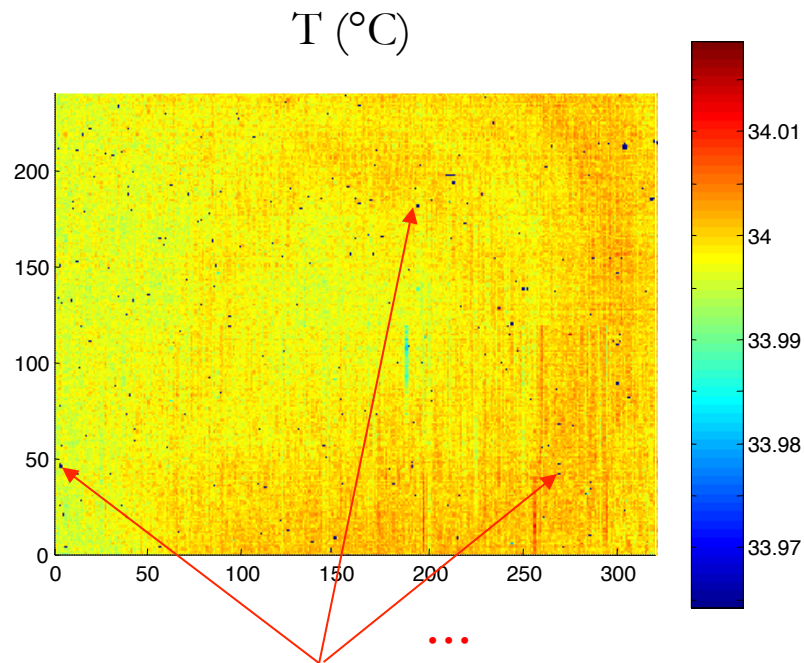

pixels whose response is
« very » different from the others

 **defective pixels**

(i) search algorithm (3 criteria) :

- in « gain » :
 $(i,j) : |\alpha_{ij} - 1| > a$
- in « offset » :
 $(i,j) : |\beta_{ij}| > b \cdot 2^{\uparrow dyn}$
- in « noise » :
 $(i,j) : \text{rms}(T_{ij}) > T_{ij} + c \cdot \text{std}(T_{ij})$

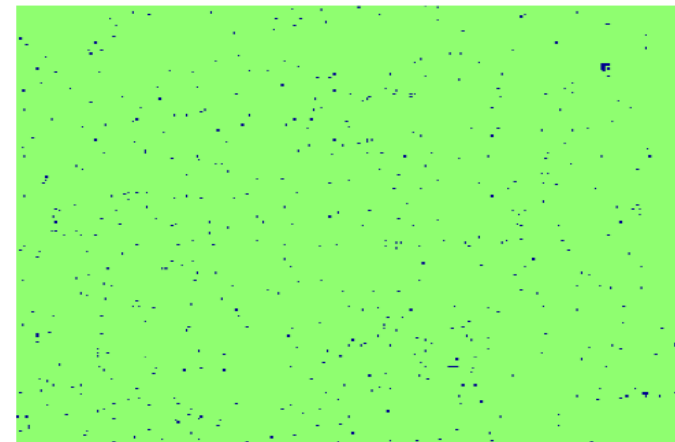

IR camera calibration (IV) : BPR

(ii) different replacement algorithms

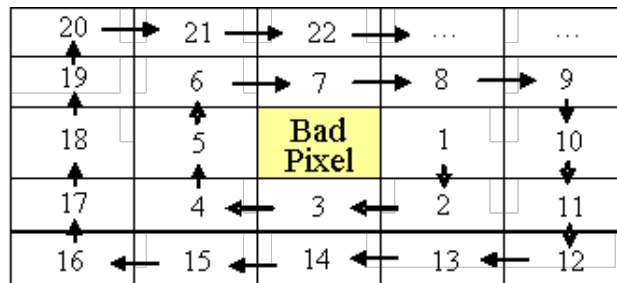

21	13	9	14	22
20	5	1	6	15
12	4	0	2	10
19	8	3	7	16
24	18	11	17	23

drawbacks of the BPR :

- introduction of **correlations** between neighboring pixels
-  errors in the estimation of gradients
- « **clusters** »

IR camera calibration (V)

laboratory procedure :
pixel by pixel calibration

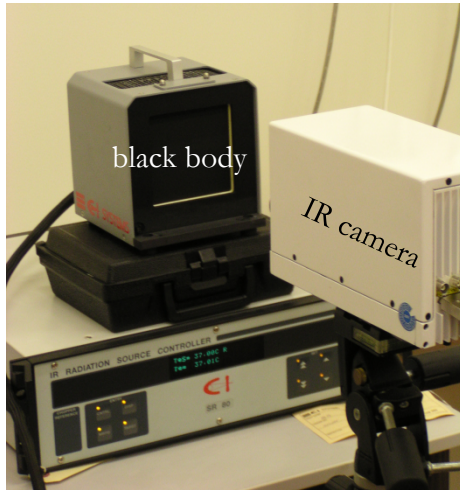

« **dead** » pixels
« **abnormal** » pixels
« **saturated** » pixels

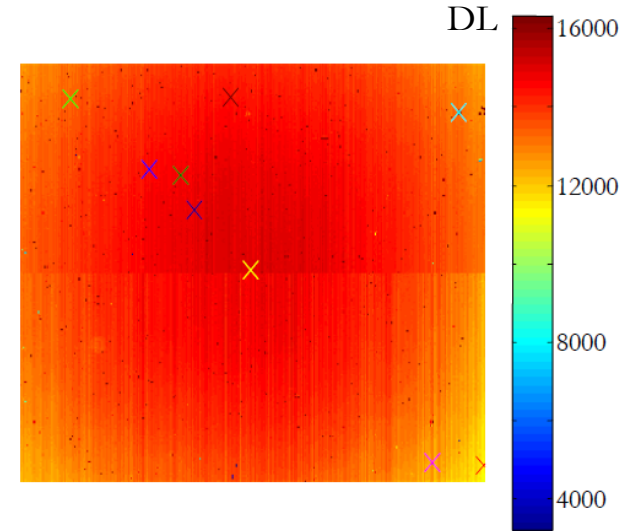

extended plane **black body** :

- $\epsilon(\lambda) \approx 0.98$
- $T(x,y) = T_0$ ($\pm 0.02^\circ\text{C}$ uniformity
 0.008°C precision)

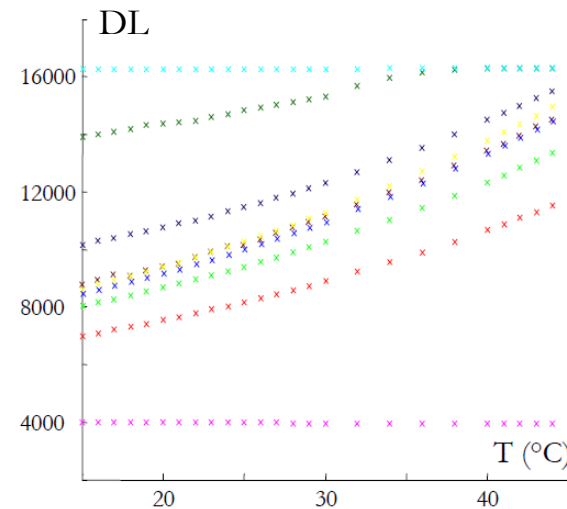

IR camera calibration (VI)

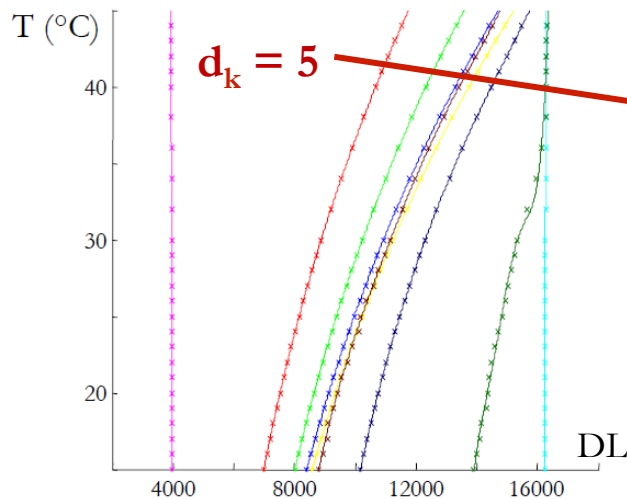

calibration relation :

$$T_{ij} = \sum_{k=0}^{d_k} d_{lk} \cdot a_{lijk} \cdot DL_{ij}^k$$

$\sum_{k=0}^{d_k} (d_k + 1) \cdot n_i \cdot n_j$ coefficients

$\sum_{k=0}^{d_k} 1\,600\,000$ for a (320×240) image

« defective » pixels determination :

$$(i,j) : \exists k, |T_{ij}^k - T_{BB}^k| > \epsilon_{dead} \quad 0.04 \text{ } ^\circ\text{C}$$

- 539 « bad » pixels $\sum_{k=0}^{d_k} 0.07\%$
- $\sum_{k=0}^{d_k}$ homogeneous distribution
- a few « clusters »

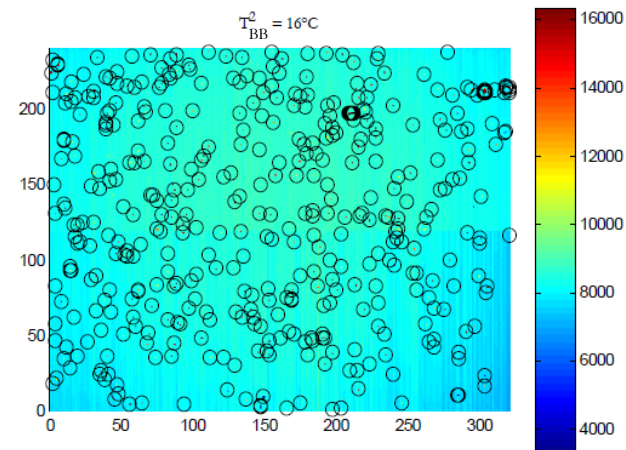

IR camera calibration (VII)

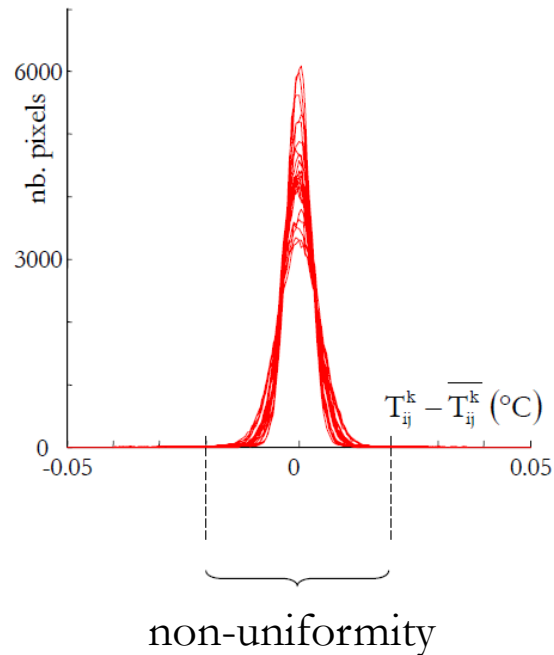

- **precision** of the black body
- **non-uniformity** $< 0.02^\circ\text{C}$

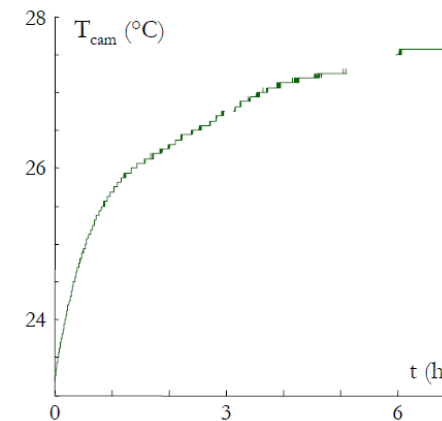

limits of the « laboratory » procedure :

- requires 1 extended **black body** (30 k€)
- **thermal stability** of the camera in its environment (4-5 h)
- 1 calibration per **shooting condition** (integration time, image size, lens, focus, ...)

Scales in Infrared Thermography

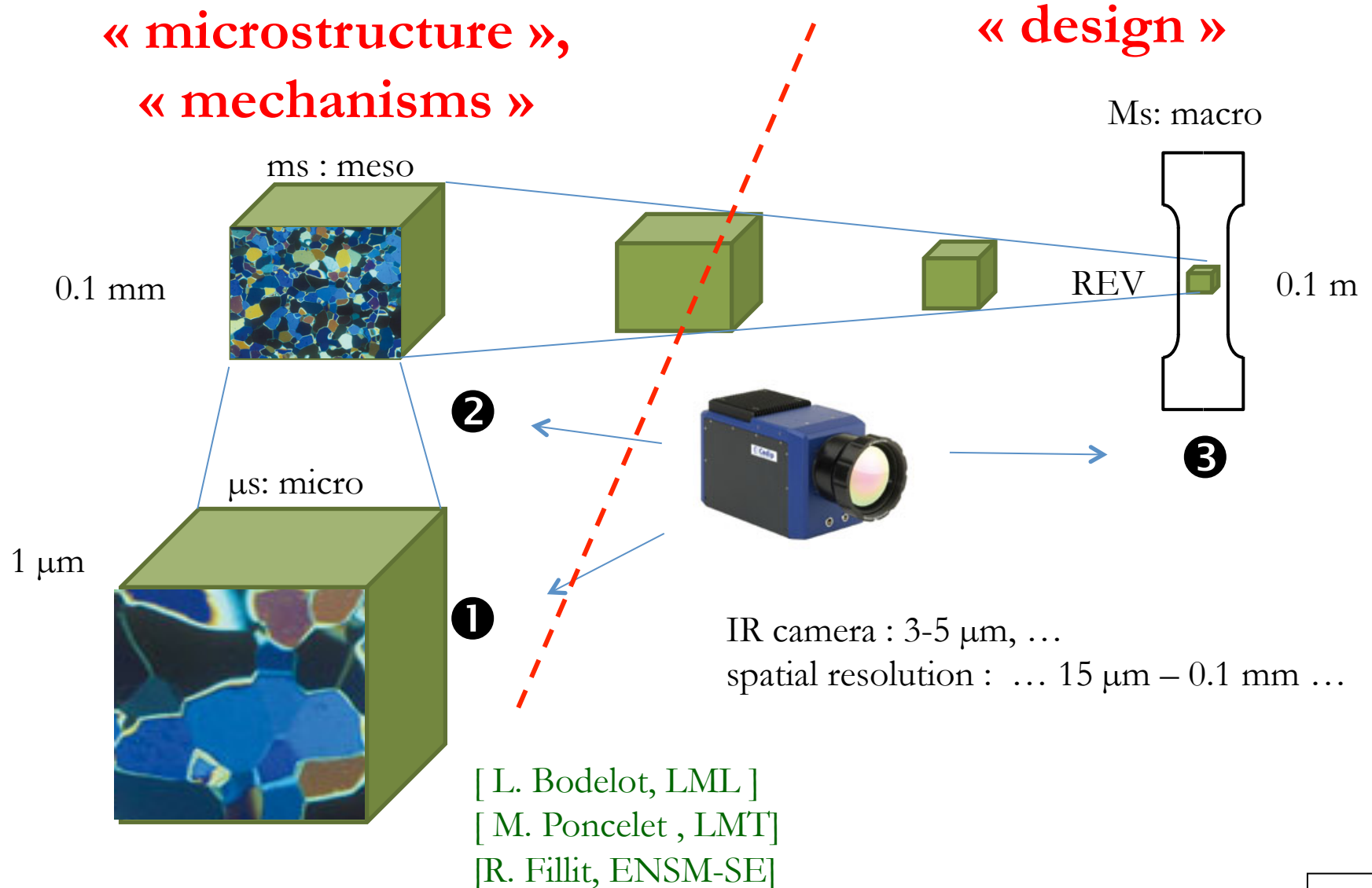

Temperature fields for IHS

- « dense » temperature fields on the boundaries
 - multiple punctual sensors (thermocouples, optical fibres pyrometers, ...)
 - IR cameras
- high temporal resolution:
 - ultra-fast imaging devices (1 MHz frame rate, scanning devices)
- emissivity determination:
 - multi-spectral thermography, ...
- multiple physics:
 - simultaneous knowledge of other state variables (strain, phase proportion, ...)
- IR tomography?
 - identification of heat sources: see IHS-1