



HAL
open science

RECIPROCATING ENGINES

Franck C.G.A Nicolleau

► **To cite this version:**

Franck C.G.A Nicolleau. RECIPROCATING ENGINES. Master. RECIPROCATING ENGINES, Sheffield, United Kingdom. 2010, pp.189. cel-01548212

HAL Id: cel-01548212

<https://hal.science/cel-01548212>

Submitted on 27 Jun 2017

HAL is a multi-disciplinary open access archive for the deposit and dissemination of scientific research documents, whether they are published or not. The documents may come from teaching and research institutions in France or abroad, or from public or private research centers.

L'archive ouverte pluridisciplinaire **HAL**, est destinée au dépôt et à la diffusion de documents scientifiques de niveau recherche, publiés ou non, émanant des établissements d'enseignement et de recherche français ou étrangers, des laboratoires publics ou privés.



Distributed under a Creative Commons Attribution - NonCommercial 4.0 International License



UNIVERSITY OF SHEFFIELD
Department of Mechanical Engineering
Mappin street, Sheffield, S1 3JD, England

RECIPROCATING ENGINES

Autumn Semester 2010

MEC403 - MEng, semester 7 - MEC6403 - MSc(Res)

Dr. F. C. G. A. Nicolleau

MD54

Telephone: +44 (0)114 22 27700. Direct Line: +44 (0)114 22 27867

Fax: +44 (0)114 22 27890

email: F.Nicolleau@sheffield.ac.uk

http://www.shef.ac.uk/mecheng/mecheng_cms/staff/fcgan/

MEng 4th year Course Tutor : Pr N. Qin

European and Year Abroad Tutor : C. Pinna

MSc(Res) and MPhil Course Director : F. C. G. A. Nicolleau

© 2010 F C G A Nicolleau, The University of Sheffield

Table of content

Table of content	3
Nomenclature	9
Introduction	13
Acknowledgement	16
I - Introduction and Fundamentals of combustion	17
1 Introduction to combustion engines	19
1.1 Piston engines	19
1.2 Other reciprocating engines	20
1.2.1 Wankel engine	20
1.2.2 HCCI engine	20
1.3 Performance parameters for combustion engines	20
2 Combustion	23
2.1 Stoichiometry	23
2.1.1 Exercise	23
2.1.2 Products of Combustion	24
2.1.3 Example	24
2.2 Combustion Thermodynamics	25
2.3 Criteria for equilibrium	27
2.3.1 Adiabatic closed system (pure substance)	27
2.3.2 Isothermal closed system	27
2.4 Emissions	28
3 Thermodynamics of reacting gas mixtures	29
3.1 Properties of an ideal gas	29
3.2 Gibbs function changes	29
3.3 Analysis of chemical equilibrium	30
3.4 Example	31
3.5 More realistic reactions in engines	34
3.5.1 Neglecting NO ($f = 0$)	34
3.5.2 With NO concentrations	35
3.5.3 Exercise	35
3.5.4 Exercise	35
3.5.5 Exercise	36
3.5.6 Exercise	36
3.6 Kinetics	36

4	Simple physics of flames and combustion	37
4.1	Premixed laminar flame	37
4.2	Diffusion flame	38
4.3	Detonation Wave	39
4.4	Ignition in Piston Engine	39
4.5	Turbulent flame	39
4.5.1	Turbulence parameters	39
4.5.2	Mixing	39
4.5.3	Turbulent flame front	40
4.6	Flame Quench	42
4.7	Diesel combustion	43
	Appendix of chapter 4	44
4.A	Bunsen burner	44
4.B	Turbulent flame propagation	44
4.C	Role of the Swirl	44
5	Equations for reactive flows	45
5.1	Mass conservation of a passive scalar	45
5.1.1	Mass variation inside a control volume	45
5.1.2	The notion of flux	46
5.1.3	The divergence theorem	47
5.1.4	The continuity equation	48
5.2	Un-reactive mixture	49
5.2.1	The scalar equation	49
5.2.2	Mass diffusion	50
5.2.3	The Fick law	51
5.2.4	Exercise	53
5.2.5	Exercise	53
5.2.6	Exercise	53
5.3	Reactive scalar	53
5.4	The energy conservation	54
5.4.1	Adding heat and work	55
5.4.2	Volume force	57
5.4.3	Heat production	58
5.4.4	The energy balance	58
5.4.5	Enthalpy conservation	59
5.4.6	Total enthalpy	59
5.4.7	Exercise	59
5.5	Energy equation for a reacting mixture	60

5.5.1	Exercise	60
5.5.2	Energy conservation for a mixture	60
5.5.3	Exercise	62
5.6	Enthalpy conservation for a reactive mixture	62
5.6.1	Exercise	62
5.7	Heat transfer	62
5.7.1	Heat transfer through mass transfer	62
5.7.2	Modelling of the total Heat transfer	63
5.8	Momentum equation	65
Revision questionnaire of Part I		67
II - Piston engines		69
6	Piston engines	71
6.1	Performance Parameters for Piston Engines	71
6.1.1	Swept volume	71
6.1.2	Torque	71
6.1.3	Power	71
6.1.4	Volumetric efficiency, η_{vol}	72
6.2	Mean effective pressure	72
6.2.1	Brake mean effective pressure p_m	72
6.2.2	Indicated mean effective pressure p_{mi}	74
6.2.3	Mechanical efficiency	74
6.3	Exercise	74
Appendix of chapter 6		76
6.A	Piston engine survey	76
7	Spark ignition engines	77
7.1	Ideal Otto cycle (Beau de Rochas)	77
7.1.1	Exercise	79
7.2	Realistic thermodynamic cycles	79
7.2.1	Effects of fuel-air Otto cycle	79
7.2.2	Effects of departure from constant volume	79
7.2.3	Effects of Heat losses from cylinder walls	80
7.2.4	Comparison with engine measurements	80
7.3	Combustion in spark ignition engines	80
7.3.1	The 'normal' combustion sequence	80
7.3.2	Effect of fuel/air ratio on ignition limits	81
7.4	Knock in Spark ignition Engines ('Spark Knock', 'Pinking', 'Detonation')	81
7.4.1	The phenomenon	81
7.4.2	The effects	82

7.4.3	Prevention of knock	82
7.4.4	Octane Number	82
Appendix of chapter 7	84
7.A	Ideal cycle /real cycle comparison	84
8	Spark ignition engines: combustion control	85
8.1	Throttle control	85
8.2	Fuel Supply	85
8.2.1	Carburettor	85
8.2.2	Injection system	87
8.2.3	Multi point injection (MPI)	87
8.3	Performance	87
8.4	Combustion chamber design	88
8.5	Emissions	89
8.5.1	Combustion Kinetics	89
8.5.2	Hydrocarbons (see Heywood Fig. 11-1)	89
8.5.3	Pollution of the Environment	90
8.5.4	Emissions control	90
8.6	Stratified charge	90
8.7	Gas exchange processes	91
8.7.1	Sequence of events in four stroke cycle engines	92
8.8	Admission Valve	92
8.8.1	Exercise	93
Appendix of chapter 8	94
8.A	Diagram of an L-Jetronic system	94
8.B	European Vehicle Exhaust Emission Standards	95
9	Combustion ignition engines: diesel engines	97
9.1	Combustion	97
9.1.1	Fundamental features	97
9.1.2	Requirements	98
9.1.3	Combustion sequence	98
9.2	Design aspects	98
9.2.1	Fuel and air requirements	98
9.2.2	General	99
9.2.3	Fuel Injection Systems	99
9.3	Fuel and cetane number	100
9.4	Emissions	100
9.4.1	Incomplete combustion products	100
9.4.2	NO _x production	101

9.5	Spark ignition engines compared to compression ignition engines	101
9.5.1	Emissions	101
9.5.2	Naturally Aspirated Engines: effect of overall fuel/air ratio	101
9.5.3	Typical parameters	102
9.5.4	Fuel consumption	102
10	Two stroke cycle engines	103
10.1	Sequence of events	103
10.2	Design Options	104
10.3	Scavenge process	104
10.3.1	Dimensionless performance parameters	104
10.3.2	Perfect displacement model	105
10.3.3	Complete mixing	106
10.3.4	Short Circuit Flow	107
10.3.5	Combined Scavenge Model	107
10.3.6	Exercise	108
10.4	Power losses from scavenge flows	108
10.4.1	Exercise	109
10.5	Comparison with four stroke engines	109
	Revision questionnaire of Part II	111
III	- Supercharging and Turbocharging	113
11	Supercharging and turbocharging	115
11.1	Purpose	115
11.1.1	supercharger	115
11.1.2	Turbochargers	116
11.1.3	Other devices	117
11.2	Thermodynamic analysis of turbochargers	117
11.3	Constant pressure turbocharging	119
11.4	Pulse system	119
11.5	Energy available	121
11.5.1	Expansion energy available at exhaust release point	122
11.5.2	Energy available from an adiabatic exhaust turbine: ideal pulse turbine	123
11.5.3	Energy available from an adiabatic exhaust turbine: Constant pressure exhaust manifold (4 stroke)	124
12	Turbocharging design and modelling	127
12.1	Design analysis	127
12.2	Turbocharger power balance	127
12.3	Mean Temperature T_e from known cylinder release conditions	129
12.4	Empirical relationship for T_e	129

12.5 Example for a good diesel	130
12.6 Exercise	131
12.7 Exercise	131
13 Elements of turbomachinery	133
13.1 Dimensional analysis of compressible flows through turbomachines	133
13.2 Velocity limits in a compressor	134
13.3 Compressor characteristic	134
13.3.1 Surge	136
13.3.2 Stall	136
13.3.3 Compressor choice	136
13.4 Real effects in exhaust turbine Systems	137
Revision questionnaire of Part III	139
IV - Other reciprocating engines	141
14 Rotary Engine (Wankel Engine)	143
15 HCCI Engine	145
Revision questionnaire of Part IV	147
Conclusion	149
List of Figures	151
MEC403 Data sheets	155
Course Work	159
Solutions to exercises	161
References	187

Nomenclature

Units refer to international system and are the one usually used in the course

B : bore of the cylinder (m)

b_{mep} : brake mean effective pressure

b_{sfc} : break specific fuel consumption ($\text{kg}\cdot\text{J}^{-1}$ but usually in $\text{kg}\cdot\text{kWh}^{-1}$)

c_p : specific heat for enthalpy ($\text{J}\cdot\text{K}^{-1}\cdot\text{kg}^{-1}$)

c_v : specific heat for energy ($\text{J}\cdot\text{K}^{-1}\cdot\text{kg}^{-1}$)

f : fuel/air (mass) ratio

g : specific Gibbs function ($\text{J}\cdot\text{kg}^{-1}$)

h : specific enthalpy ($\text{J}\cdot\text{kg}^{-1}$)

\tilde{h} : molar enthalpy ($\text{J}\cdot\text{mol}^{-1}$)

i_{sfc} : indicated specific fuel consumption ($\text{kg}\cdot\text{J}^{-1}$ but usually in $\text{kg}\cdot\text{kWh}^{-1}$)

m : mass (kg)

\tilde{m} : molar mass ($\text{kg}\cdot\text{mol}^{-1}$)

n : number of moles of gas (mol)

n_{cy} : number of cylinders

p : pressure (Pa i.e. $\text{kg}\cdot\text{m}^{-1}\cdot\text{s}^{-2}$)

p_{bm} : brake mean effective pressure (Pa)

p_{fm} : friction mean effective pressure (Pa)

p_m : mean effective pressure (Pa)

p_{mi} : indicated mean effective pressure (Pa)

q : heat per unit mass ($\text{J}\cdot\text{kg}^{-1}$)

\tilde{R} : (or R_u) molar gas constant (universal) $8.3145 \text{ J}\cdot\text{mol}^{-1}\cdot\text{K}^{-1}$

- R : gas constant $\frac{\tilde{R}}{m}$ ($\text{J.kg}^{-1}.\text{K}^{-1}$)
- r_p : pressure ratio in gas turbine cycle
- r_v : compression ratio
- s : specific entropy ($\text{J.K}^{-1}.\text{kg}^{-1}$)
- sf_c : specific fuel consumption (kg.J^{-1} but usually in kg.kWh^{-1})
- \tilde{s} : molar entropy ($\text{J.K}^{-1}.\text{mol}^{-1}$)
- T : Temperature (K or °C)
- u : specific internal energy (J.kg^{-1})
- U : internal energy
- V : volume (m^3)
- V_s : swept volume (m^3)
- \tilde{v} : molar volume $\frac{V}{n}$ ($\text{m}^3.\text{mol}^{-1}$)
- \mathcal{V} : velocity
- w : work per unit mass (J.kg^{-1})

Greek symbols

- α : air/fuel mass ratio
- α_v : air/fuel volume ratio
- γ : ratio of heat capacity $\gamma = \frac{c_p}{c_v} = \frac{\tilde{c}_p}{\tilde{c}_v}$
- ϕ : equivalence ratio
- η_o : overall efficiency
- η_{vol} : volumetric efficiency
- η_c : compressor efficiency
- η_t : turbine efficiency
- λ : excess air ratio
- ρ : density $\frac{1}{v} = \frac{m}{V}$ (kg.m^{-3})

τ : crankshaft torque ($N.m$)

Abbreviation

EGR : exhaust gas recirculation

EVC : Exhaust valve closes

IVC : inlet valve closes

IVO : inlet valve opens

LCV : low calorific value

PF : pulse factor

PLF : pressure loss factor

WOT : wide opened throttle

Notation

$\tilde{}$: molar, quantity $\tilde{A} = A$ per moles

specific : quantity per unit mass, usually small letters

Introduction

Purpose

This module is largely (but freely) inspired from a previous one delivered by Mr R. Saunders (MPE310 Combustion Engines). It relies on thermodynamics basics acquired in 1st (Beck, 2000) and 2nd (Smyth, 1999) year of M.Eng. in Mechanical Engineering. Elements of the course MEC310 (Nicolleau, 2001) may be useful.

This module considers the performance of and emissions from reciprocating combustion engines. It should enable students to recognise the salient aspects of combustion thermodynamics and flame structure in each type of engine and to perform simple chemical equilibrium analyses; to analyse the performance and explain the emissions characteristics of piston engines, including spark ignition, compression ignition and turbocharging.

In Practice

- 12 weeks of teaching,
- 20 off one-hour formal lectures,
- 4 hours used as class example, applications, class revision,
- 2-hour seminar given by Pr G. Kalghatgi
- a two-hour examination.

Lectures in 2006: SG-ME04: Tuesday 09:00-09:50
SG-F110: Friday 11:10-12:00

Lecture List (indicative)

Week 1	26 09 2010	Lecture 1	introduction, chapter 1, chapter 2
	29 09 2010	Lecture 2	chapter 2, chapter 3
Week 2	03 10 2010	Lecture 3	chapter 3
	06 10 2010	Lecture 4	chapter 3
Week 3	10 10 2010	Lecture 5	chapter 4
	13 10 2010	Lecture 6	chapter 5 - Scalar transport equation
Week 4	17 10 2010	Lecture 7	chapter 5 - enthalpy of a reactive mixture
	20 10 2010	Lecture 8	chapter 5, chapter 6
Week 5	24 10 2010	Lecture 9	chapter 6, chapter 7
	27 10 2010	Lecture 10	chapter 7, chapter 8
Week 6	31 10 2010	Lecture 11	chapter 8, chapter 9
	03 11 2010	Lecture 12	chapter 9
Week 7	07 11 2010	Lecture 13	chapter 9, chapter 10
	10 11 2010	Lecture 14	NO LECTURE account for tutorial
Week 8	14 11 2010	Lecture 15	chapter 10, chapter 11
	17 11 2010	Lecture 16	chapter 12
Week 9	21 11 2010	Lecture 17	chapter 13
	24 11 2010	Lecture 18	chapter 14 - Wankel engine
Week 10	28 11 2010	Lecture 19	chapter 15 - HCCI engine - Last lecture
	01 12 2010	Lecture 20	NO LECTURE account for tutorial
Week 11	05 12 2010	Lecture 21	NO LECTURE account for tutorial
	08 12 2010	Lecture 22	NO LECTURE account for tutorial
Week 12	12 12 2010	Lecture 23	NO LECTURE, replaced by a seminar TBA
	15 12 2010	Lecture 24	NO LECTURE, replaced by a seminar TBA
Seminar	Week 7 ????		
Week 13 - 15	15 01 2007 to 03 02 2007	EXAMINATIONS	

The Course is now housed on the WebCT of the university of Sheffield

<http://vista.shef.ac.uk> (formally <http://webct.shef.ac.uk>)

Contact me if you have difficulty accessing the site.

Examination

A two hour formal examination	80 %	$\left\{ \begin{array}{l} - \text{a series of questions on the course} \\ - \text{2 exercises (25 \% each)} \end{array} \right.$	30 %
			50 %
One course work	20 %	- a report on the 2-hour seminar	

Recommended Textbooks

Tables required:

The Little book of thermodynamics

You can find it on WebCT or buy a copy 1

Recommended Textbooks

Stone (1999), Heywood (1988)

Acknowledgement

I gratefully acknowledge help and advice from Mr R. Saunders Lecturer in the Department of Mechanical Engineering, The University of Sheffield.

Prof. G. T. Kalghatgi - Senior Scientist, Shell Global Solutions (UK) - participation to the Combustion chapter when he was a Visiting Professor in the Department of Mechanical Engineering was greatly appreciated.

Prof. X. Lys, former Senior Scientist Renault (France) and visiting professor at Ecole Centrale de Lyon was kind enough to give helpful comments on the Piston Engine part.

Part I

Introduction and Fundamentals of combustion

Chapter 1: Introduction to combustion engines

There are two main combustion engines

- Piston engines either spark ignition or diesel
- and gas turbine

1.1 Piston engines

- Four stroke engine Four and two stroke engines can be either spark engine or diesel engine

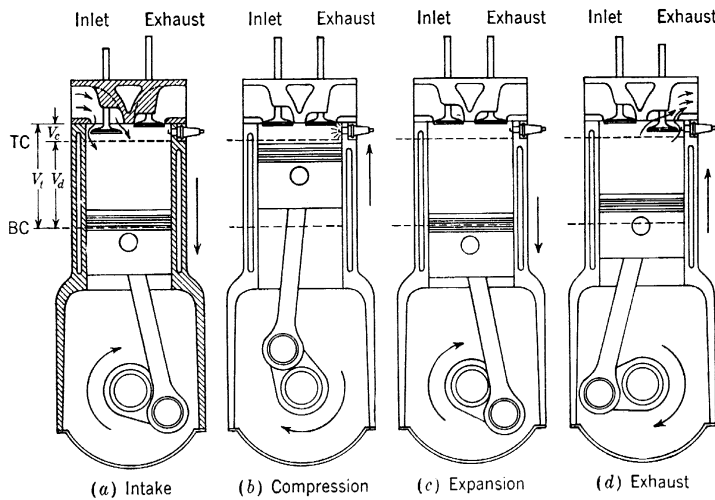

from Heywood (1988)
figure 1-2 page 10

Figure 1.1. The four stroke operating cycle

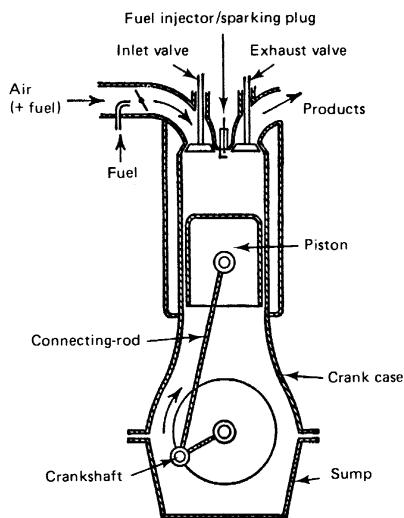

In a spark engine
air and fuel are premixed before the compression
and the combustion needs to be initiated with a spark

In a compression engine (diesel)
fuel is sprayed into the compressed air
and the resulting compressed mixture auto-ignites locally.

Figure 1.2. Four stroke piston engine

- Two stroke spark engine

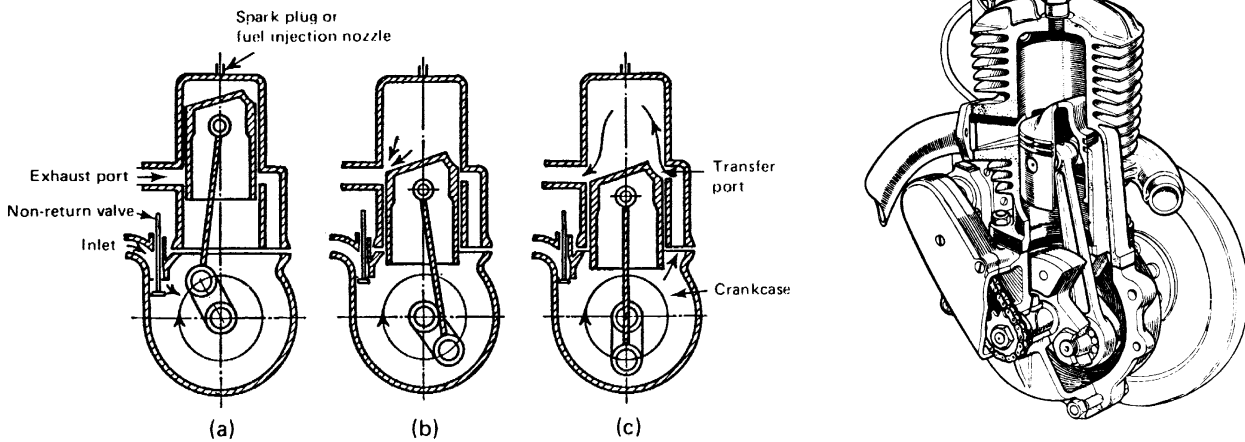

Figure 1.3. Two stroke piston engine

1.2 Other reciprocating engines

1.2.1 WANKEL ENGINE

1.2.2 HCCI ENGINE

1.3 Performance parameters for combustion engines

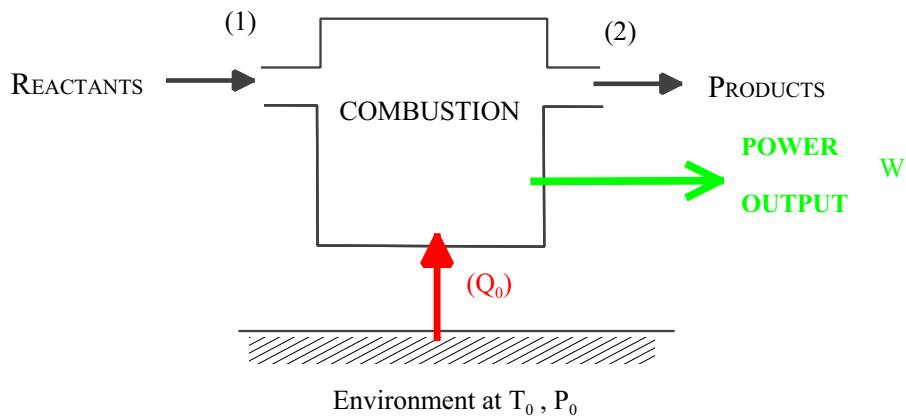

Figure 1.4. Thermal efficiency

Thermal Efficiency η_{th} also known as fuel conversion efficiency η_f : (overall arbitrary efficiency η_o Nicolleau (2001))

$$\eta_{th} = \frac{\text{power output}}{\text{fuel energy input rate}} = \frac{\dot{W}}{\dot{m}_f \times LCV}$$

(1.1)

where

\dot{m}_f is the fuel mass flow rate

LCV is the **Lower Calorific Value** of fuel

(i.e. combustion Δh per kg of fuel when H_2O in products is **not** condensed)

specific fuel consumption

$$sfc = \frac{\dot{m}_f}{\dot{W}}$$

(1.2)

It is usually given in $kg.kWh^{-1}$:

$$sfc = 3600 \times \frac{\dot{m}_f}{\dot{W}} = \frac{3600}{\eta_{th} LCV} \text{ in } kg.kWh^{-1} \quad (1.3)$$

(in formula (1.3) has to be in $kJ.kg^{-1}$.) For piston engines (see chapter 6) this can be either a brake measurement **bsfc** or based on indicated power **isfc**.

Air/fuel (mass) ratio:

$$\alpha = \frac{\text{air mass}}{\text{fuel mass}} = \frac{1}{f} \quad (1.4)$$

where f is the fuel/air ratio. Also

$$\alpha_v = \frac{\text{air volume}}{\text{fuel volume}} = \frac{\text{moles of air}}{\text{moles of fuel}}$$

(e.g. natural gas.)

Chapter 2: Combustion

2.1 Stoichiometry

Fuel is normally a hydrocarbon (C_xH_y) air is the oxidant (approximately 21 % of oxygen O_2 , 79 % of nitrogen N_2 by volume or mol)

Example of a typical overall reaction, with pentane fuel (C_5H_{12}):

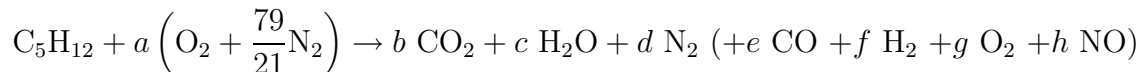

Assume that for a stoichiometric mixture, $e = f = g = h = 0$. Then element balances give:

Carbon $5 = b$

Hydrogen $12 = 2c$ that is $c = 6$

Oxygen $2a = 2b + c$ so that $a = 8$

Nitrogen $3.76a = d$ so that $d = 30.1$

Air fuel (mass) ratio:

$$\alpha = \frac{\text{mass air}}{\text{mass fuel}} = \frac{a(32 + 3.76 \times 28)}{5 \times 12 + 12}$$

Stoichiometric α :

$$\alpha_{st} = \frac{137.3a}{72} = 15.26 \text{ kg/kg (for } C_5H_{12}\text{)}$$

Fuel/air ratio is $f = 1/\alpha$

The relative fuel/air ratio is **called equivalence ratio ϕ** :

$$\phi = \frac{\text{fuel/air}}{(\text{fuel/air})_{st}} = \frac{f}{f_{st}} = \frac{1/\alpha}{1/\alpha_{st}} = \frac{\alpha_{st}}{\alpha}$$

(2.1)

the equivalence ratio ϕ is the ratio of the actual fuel/air ratio to the stoichiometric fuel/air ratio.

Excess air ratio λ :

$$\lambda = \frac{\alpha}{\alpha_{st}} = \frac{1}{\phi}$$

If $\alpha > \alpha_{st}$ there is an excess of air, the mixture is **lean** or **weak** ($\phi < 1$, $\lambda > 1$)

If $\alpha < \alpha_{st}$ there is an excess of fuel, the mixture is **rich** ($\phi > 1$, $\lambda < 1$)

2.1.1 EXERCISE

- a) Calculate the stoichiometric fuel/air ratio for Octane C_8H_{18} .

- b) Hence find the enthalpy of combustion per kg air of this mixture at 298 K when all products are vapour.
- c) Same as b) when all products and octane are liquid
- d) Which one of b) or c) is the relevant value for combustion engines.
- e) Using b) Find the internal energy of combustion $\Delta\tilde{u}$ for 1 kmol of octane (all vapour).

Answers: a) 0.0664, b) 2980 kJ, c) 3186 kJ, d) all vapour, e) 2985 kJ

2.1.1.2 PRODUCTS OF COMBUSTION

- a) For stoichiometric Pentane/air:

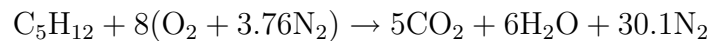

- b) For a lean mixture, suppose $\Phi = 0.8$ ($\alpha = 19.1$, $\lambda = 1.25$) and assume $e = f = h = 0$ then

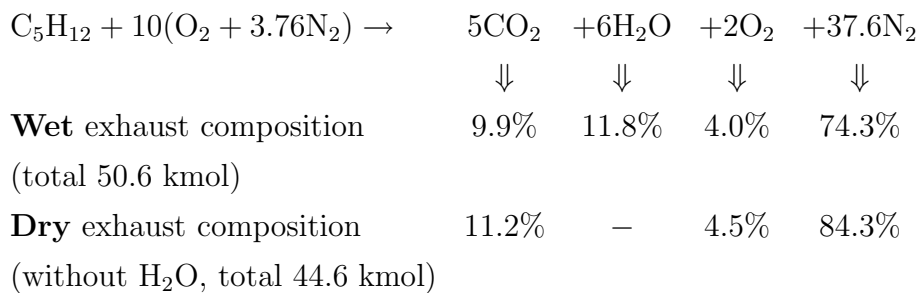

- c) For a rich mixture, take $\lambda = 0.9$ ($\Phi = 1.053$, $\alpha = 13.73$) and assume $f = g = h = 0$ then

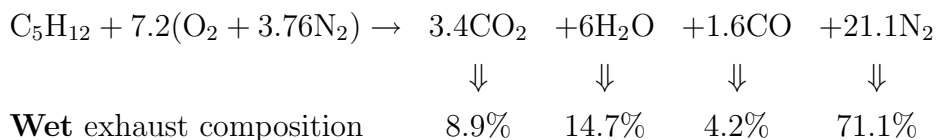

2.1.1.3 EXAMPLE

Measurements of the dry exhaust gas composition from an engine test gives:

$$\left\{ \begin{array}{l} 13.2\% \quad \text{CO}_2 \\ 0.6\% \quad \text{CO} \\ 2.4\% \quad \text{O}_2 \end{array} \right.$$

deduce the equivalence ratio ϕ for the fuel/air mixture assume all the remaining exhaust is N₂:

$$\text{N}_2: 100 - (13.2 + 0.6 + 2.4) = 83.8\%$$

Fuel is C_xH_y, let us consider 100 dry kmol of exhaust:

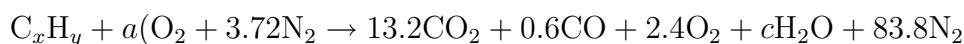

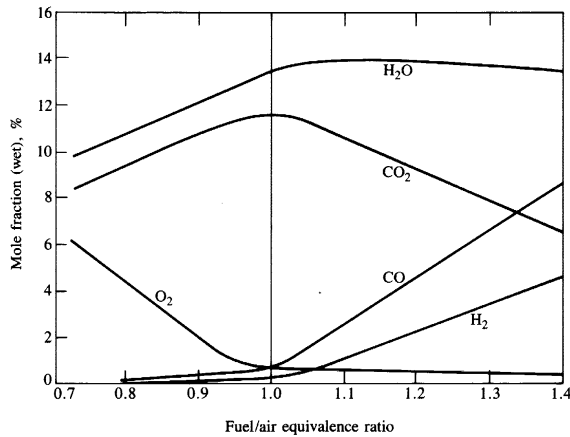

Figure 2.1. Wet exhaust gas species concentration as a function of fuel/air ϕ equivalence ratio

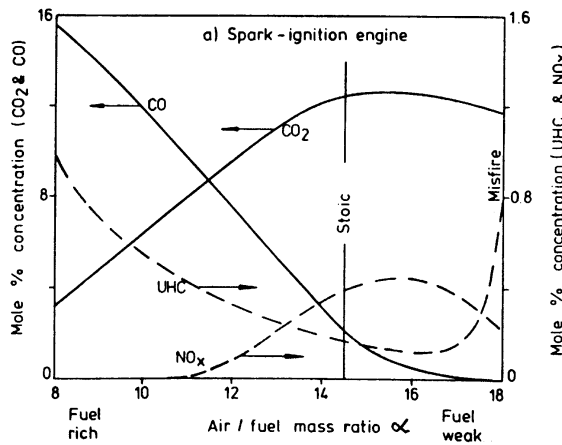

Figure 2.2. Concentration in CO and CO₂ in the products (dry)

carbon : $x = 13.2 + 0.6 = 13.8$

nitrogen N₂ : $3.76a = 83.8 \Rightarrow a = 22.29$

oxygen O : $2a = 2 \times 13.2 + 0.6 + 2 \times 2.4 + c \Rightarrow c = 2a - 31.8 = 12.77$

hydrogen H : $y = 2c = 25.55$

For stoichiometric reaction:

$$a_{st} = x + \frac{y}{4} = 20.19$$

Hence

$$\phi = \frac{a_{st}}{a} = \frac{20.19}{22.29} = 0.906$$

the mixture is 9.4% lean.

2.2 Combustion Thermodynamics

We need to take account of the effects of high temperatures on:

- a) gas properties
- b) energy release
- c) chemical equilibrium

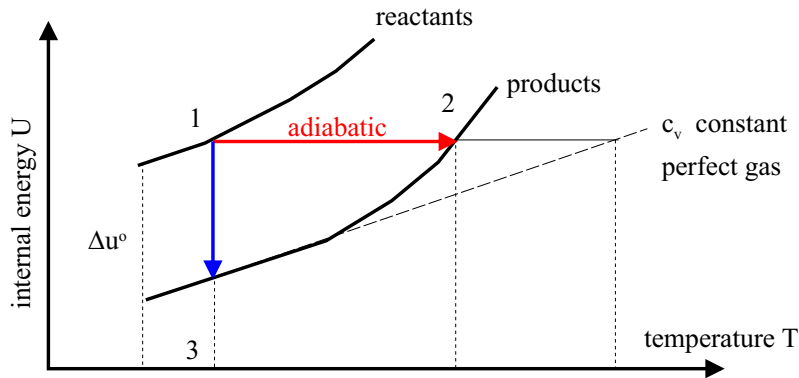
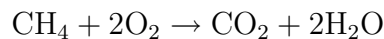
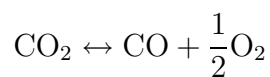

Figure 2.3. Energy of formation as a function of temperature

- a) Accurate data for c_v is essential to establish adiabatic end temperature for products (ideal air cycle grossly overestimates this because of constant c_v assumption).
- b) Relative position of products curve is determined by $\Delta\tilde{u}^\ominus$ for the given reaction.
- c) consider



But at high temperature, dissociation of some of the CO_2 occurs i.e.



so e.g.

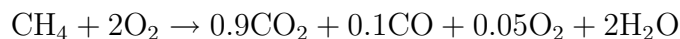

Hence

- The composition of the products is controlled by **chemical equilibrium**
- The energy released depends on this (e.g. only $0.9 \Delta\tilde{u}^\ominus$ in the example - and similarly a reduction in the adiabatic temperature rise)
- The resultant products may contain toxic species (in this case CO) which tend to survive into the emitted gases.

2.3 Criteria for equilibrium

2.3.1 ADIABATIC CLOSED SYSTEM (PURE SUBSTANCE)

Mechanical Equilibrium across the system implies uniform pressure

Thermal Equilibrium across the system implies uniform temperature

If both pressure and temperature can change together, the Second Law requires that for any externally adiabatic process (e.g. mixing between hot and cold parts but with $Q = 0$):

$$dS \geq 0$$

This (irreversible) process will continue until equilibrium is reached, when S reaches a constant value, i.e. $dS = 0$ which is the criterion for equilibrium. This implies that small reversible changes may take place between components of the system, but the overall condition of equilibrium is not thereby disturbed.

2.3.2 ISOTHERMAL CLOSED SYSTEM

If system is in mechanical and thermal equilibrium with its surroundings, pressure and temperature are constant, but there may be some Heat Transfer, Q .

2nd Law now requires:

$$dS - \frac{\delta Q}{T} \geq 0$$

By the same argument as §2.3.1, the criterion for equilibrium is

$$\delta Q - TdS = 0$$

but from 1st Law:

$$\delta Q = dU + \delta W = dU + pdV \text{ (when reversible)}$$

Hence

$$dU + pdV - TdS = 0$$

But the Gibbs Function $G = H - TS = -U + pV - TS$ for constant pressure and temperature:

$$dG = dU + pdV - TdS$$

and at given values of T, p the **criterion for equilibrium** is:

$$dG = 0$$

This applies to any effect at a specified combination of p, T including chemical, phase, electric or nuclear changes.

2.4 Emissions

- Nitrogen oxides: NO_2 , NO_x

They are formed mainly from road traffic fumes and burning of fossil fuels.

Effects: A respiratory irritant that leads to increases in asthma and susceptibility to infection.

- Carbon monoxide: CO

Mainly due to emissions from vehicle exhausts.

Effects: Toxic and easily absorbed by the blood, blocking oxygen receptors. It causes headaches and tiredness. Fatal in high concentrations.

- Small particles known as PM10

Tiny particles created by diesel combustion that penetrate deep into the lungs.

Effects: Risk of heart, lung and respiratory diseases. Increased incidence of lung cancer and cot death.

- Ozone: O_3

Effects: irritates eyes, nose and throat, reduces lung capacity and increases asthma and respiratory diseases.

Chapter 3: Thermodynamics of reacting gas mixtures

3.1 Properties of an ideal gas

Properties of an ideal gas with variable c_v and c_p (i.e. non perfect) (Nicolleau, 2001,)

$$\text{Equation of state: } p_i V = n_i \tilde{R} T \quad \text{for each gas } i \text{ at partial pressure } p_i$$

$$\text{Internal Energy: } u = u_0 + \int_{T_0}^T c_v dT$$

$$\text{Enthalpy: } h = h_0 + \int_{T_0}^T c_p dT$$

For convenience, the tables choose $h_0 = 0$ at $T_0 = 25^\circ\text{C}$ (298 K) and tabulate

$$\tilde{h} = \tilde{m} h = \tilde{m} \int_{298}^T c_p dT \quad \text{per kmol}$$

and

$$\tilde{u} = \tilde{h} - \tilde{R} T$$

(see Rogers & Mayhew, 1998, pp 18-20 for values). Note that all changes in h , u due to chemical change require the use of

- either the enthalpy of formation $\Delta \tilde{h}_{fo}^\circ$ (see Rogers & Mayhew, 1998, p 22)
- or the enthalpy of reaction $\Delta \tilde{h}^\circ$ (see Rogers & Mayhew, 1998, p 21)

Entropy:

$$\tilde{s} = \Delta \tilde{s}^\circ - \tilde{R} \ln \left(\frac{p}{p^\circ} \right) \quad \text{J.mol}^{-1}.\text{K}^{-1} \quad (3.1)$$

where $p^\circ = 1$ bar and

$$\tilde{s}^\circ = \int_0^T c_p \frac{dT}{T}$$

depends only on absolute temperature T .

3.2 Gibbs function changes

For a given chemical reaction

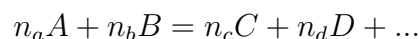

$$\Delta G = (H - TS)_P - (H - TS)_R$$

or, at temperature T

$$\Delta G_T = n_a \Delta \tilde{h}^\circ - T \left(\sum_P n_i \tilde{s}_i - \sum_R n_i \tilde{s}_i \right)$$

Hence ΔG_T depends on partial pressures p_i of each species in both Products, and Reactants mixtures because of the s_i terms as in equation (3.1) above.

The **standard gibbs function change** ΔG^\ominus is the value of ΔG_T when each p_i is taken as the standard pressure p^\ominus (i.e. all $\tilde{R} \ln(\frac{p_i}{p^\ominus}) = 0$ in the s_i terms), and is hence that part of ΔG_T which depends only on the temperature T at which equilibrium is to be considered. Then

$$\Delta G_T = \Delta G^\ominus + \tilde{R}T \left[\sum_P n_i \ln \left(\frac{p_i}{p^\ominus} \right) - \sum_R n_i \ln \left(\frac{p_i}{p^\ominus} \right) \right]$$

3.3 Analysis of chemical equilibrium

Consider the reversible reaction

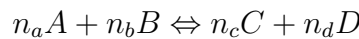

to be at equilibrium in a reacting mixture containing A, B, C, D and other species (e.g. N₂).

e.g. for CO + 1/2 O₂ we would have

$$\left\{ \begin{array}{ll} \text{A as CO} & n_a = 1 \\ \text{B as O}_2 & n_b = 1/2 \\ \text{C as CO}_2 & n_c = 1 \end{array} \right.$$

For chemical equilibrium, $dG = 0$, i.e. $\Delta G_T = 0$ and hence

$$\Delta G^\ominus + \tilde{R}T \left[n_c \ln \left(\frac{p_c}{p^\ominus} \right) + n_d \ln \left(\frac{p_d}{p^\ominus} \right) - n_a \ln \left(\frac{p_a}{p^\ominus} \right) - n_b \ln \left(\frac{p_b}{p^\ominus} \right) \right] = 0$$

Then

$$\frac{-\Delta G^\ominus}{\tilde{R}T} = \ln \left[\frac{p_c^{n_c} p_d^{n_d}}{p_a^{n_a} p_b^{n_b}} (p^\ominus)^{\Delta n} \right] = \ln K^\ominus$$

(3.2)

where $\Delta n = n_a + n_b - (n_c + n_d)$ and K^\ominus :

is the equilibrium constant for the reaction

is dimensionless

is dependent on T only.

e.g. for CO + 1/2 O₂ ⇌ CO₂:

$$K^\ominus = \frac{p_{CO_2} (p^\ominus)^{\frac{1}{2}}}{p_{CO} (p_{O_2})^{\frac{1}{2}}} \tag{3.3}$$

Values for $\ln K^\ominus$ for a range of temperatures are given for some reactions in the tables (see Rogers & Mayhew, 1998, p 21) or if necessary could be obtained from

$$\ln K^\ominus = \frac{-\Delta G^\ominus}{\tilde{R}T} \quad (3.4)$$

Hence to evaluate the product composition at temperature T in an assumed overall reaction such as $\text{CH}_4 + 2 \text{O}_2 \rightarrow a \text{CO}_2 + b \text{CO} + c \text{O}_2 + 2 \text{H}_2\text{O}$

it is only necessary to look up $\ln K^\ominus$ at temperature T for $\text{CO} + 1/2 \text{O}_2 \rightleftharpoons \text{CO}_2$ and combine the element balances for C and O with equation (3.3) to solve for a, b and c.

3.4 Example

A)

A stoichiometric mixture of CO and O₂ enters a steady flow burner at 25°C and 1 bar. For combustion at constant pressure calculate

- i) the composition of the products when the final exit temperature is 2600 K
- ii) the heat transfer from the burner per kmol of CO

A-1)

The overall reaction may be written as:

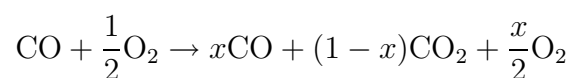

and for equilibrium within the products,

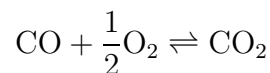

From tables Rogers & Mayhew (1998), at 2600 K,

$$\ln K^\ominus = \ln \left[\frac{p_{\text{CO}_2}(1)^{\frac{1}{2}}}{p_{\text{CO}}(p_{\text{O}_2})^{\frac{1}{2}}} \right] = 2.8$$

Now, since for each species sharing volume V , $p_i V = n_i \tilde{R}T$ then

$$\frac{\tilde{R}T}{V} = \frac{p_{\text{CO}}}{x} = \frac{p_{\text{CO}_2}}{1-x} = \frac{p_{\text{O}_2}}{\frac{x}{2}} = \frac{p_P}{n^P}$$

where p_P is the total pressure of the products (1 bar) and $n^P = x + (1 - x) + \frac{x}{2} = 1 + \frac{x}{2}$ hence

$$\begin{cases} p_{CO} &= \frac{x}{1+\frac{x}{2}} \\ p_{CO_2} &= \frac{1-x}{1+\frac{x}{2}} \\ p_{O_2} &= \frac{\frac{x}{2}}{1+\frac{x}{2}} \end{cases}$$

$$K^\ominus = e^{2.8} = \frac{\frac{1-x}{1+\frac{x}{2}}}{\left(\frac{x}{1+\frac{x}{2}}\right) \left(\frac{\frac{x}{2}}{1+\frac{x}{2}}\right)^{\frac{1}{2}}}$$

$$\frac{(K^\ominus)^2 x^3}{2+x} = (1-x)^2$$

This cubic equation requires iterative solution (initial guess $x=0.1, 0.184, 0.175, 0.1762, 0.1761$).

Hence

$$\%CO: \quad \frac{x}{n^P} = 16.2\%$$

$$\%CO_2: \quad \frac{1-x}{n^P} = 75.7\%$$

$$\%O_2: \quad \frac{x}{2n^P} = 8.1\%$$

A-II)

Heat transfer

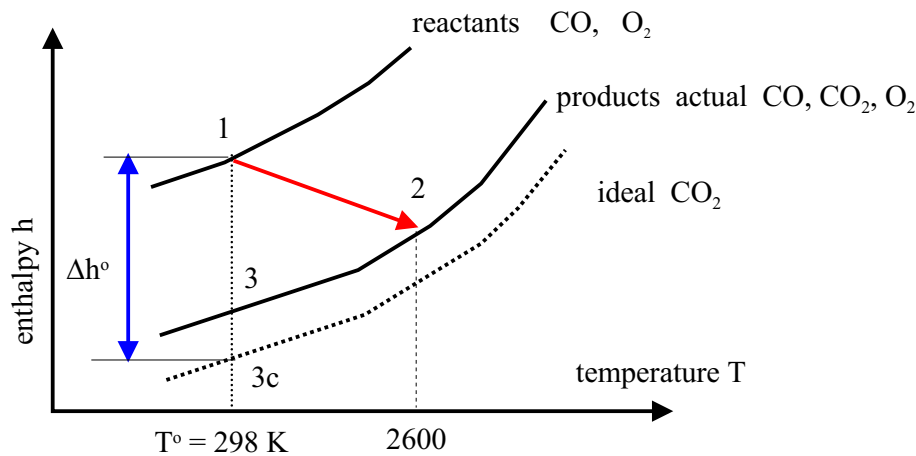

Figure 3.1. Example: heat exchange

$$\tilde{h}_1 - \tilde{h}_{3c} = \Delta\tilde{h}^\ominus = 282990 \text{ kJ.kmol}^{-1}$$

but

$$\tilde{h}_1 - \tilde{h}_3 = (1-x)\Delta\tilde{h}^\ominus = 233155 \text{ kJ.kmol}^{-1}$$

SFEE: $Q = H_1 - H_2 = (H_1 - H_3) - (H_2 - H_3)$ per kmol of CO. Now

$$\begin{aligned} H_2 - H_3 &= x(\tilde{h}_2 - \tilde{h}_3)_{CO} + (1-x)(\tilde{h}_2 - \tilde{h}_3)_{CO_2} + \frac{x}{2}(\tilde{h}_2 - \tilde{h}_3)_{O_2} \\ &= 0.1761 \times (78714 - 0) + 0.8239 \times (128080 - 0) + 0.0881 \times (82274 - 0) \\ &= 126631 \text{ kJ.kmol}^{-1} \text{ of CO} \end{aligned}$$

Hence

$$Q = 233115 - 126631 = 106524 \text{ kJ.kmol}^{-1} \text{ of CO}$$

B)

How would the composition of the products differ if the same mixture were obtained in a rigid vessel and ignited, and the final temperature was again 2600 K?

For combustion at constant volume, $p_2 \neq 1$ bar, but since T_2 is known, we can use

$$V = n_1 \frac{\tilde{R}T_1}{p_1} = n_2 \frac{\tilde{R}T_2}{p_2}$$

or

$$\frac{p_2}{n_2} = \frac{p_1 T_2}{n_1 T_1} = \frac{1}{1.5} \times \frac{2600}{298} = 5.817 \text{ bar/kmol}$$

Hence $p_{co} = 5.817x$, $p_{co_2} = 5.817(1-x)$, $p_{o_2} = 5.817x/2$ and

$$(K^\ominus)^2 x^3 \times 2.9083 = (1-x)^3$$

try 0.1, 0.101, 0.10091. And $n_2 = 1 + \frac{x}{2} = 1.0505$, $p_2 = 6.11$ bar

$$\begin{aligned} \%CO &= 9.6\% \\ \%CO_2 &= 85.6\% \\ \%O_2 &= 4.8\% \end{aligned}$$

c)

Repeat (a) with air in place of O_2

If nitrogen is included, the overall reaction becomes

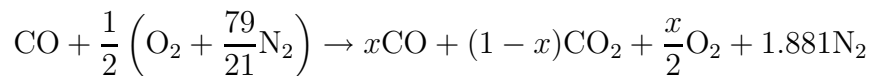

so $n^P = 1 + \frac{x}{2} + 1.881 = 2.881 + \frac{x}{2}$ and

$$x^3 \times 270.43 = (1-x)^2 (5.762 + x)$$

try 0.1, 0.26, 0.23, 0.236, 0.2350, then $n^P = 2.999$

$$\begin{aligned} \%CO &= 7.84\% \\ \%CO_2 &= 25.5\% \\ \%O_2 &= 3.92\% \\ \%N_2 &= 62.7\% \end{aligned}$$

Heat transfer

$$\begin{aligned}
 H_1 - H_3 &= 0.765 \times 282990 &= 216487 \text{ kJ.kmol}^{-1} \text{ of CO} \\
 H_2 - H_3 &= \underbrace{126146}_{\text{CO} + \text{CO}_2 + \text{O}_2} + \underbrace{146678}_{\text{N}_2} &= 272824 \text{ kJ.kmol}^{-1} \text{ of CO} \\
 Q_{out} &= 216487 - 272824 = -56337 \text{ kJ.kmol}^{-1} \text{ of CO}
 \end{aligned}$$

Need to heat the flame to reach the 2600°C.

3.5 More realistic reactions in engines

In practice

- More chemical species (e.g. H₂, NO, H, O, OH)
- Non stoichiometric reactants.

Example: Methane (CH₄) in air

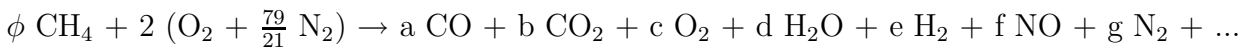

3.5.1 NEGLECTING NO ($f = 0$)

- a) Lean mixture ($\phi < 1$) assume $e = 0$ and consider equilibrium within the product mixture of
 $\text{CO} + \frac{1}{2} \text{O}_2 \rightleftharpoons \text{CO}_2$ only

$$\text{then } \left\{ \begin{array}{l} \text{C balance} \quad \phi = a + b \\ \text{H balance} \quad 4\phi = 2d \\ \text{O balance} \quad 4 = a + 2b + 2c + d \\ \text{N balance} \quad 4\frac{79}{21} = 2g \end{array} \right.$$

with $\frac{p_{\text{CO}}}{a} = \frac{p_{\text{CO}_2}}{b} = \frac{p_{\text{O}_2}}{c} = \frac{p_{\text{H}_2\text{O}}}{d} = \frac{p_{\text{N}_2}}{g} = \frac{p_2}{n_2}$

$n_2 = a + b + c + d + g$ and

$$K^\ominus = \frac{p_{\text{CO}_2} (p^\ominus)^{\frac{1}{2}}}{p_{\text{CO}} (p_{\text{O}_2})^{\frac{1}{2}}}$$

is the closing equation to solve for the 5 unknown coefficients.

- b) Rich mixture ($\phi > 1$) assume $c = 0$ and consider equilibrium of
 $\text{H}_2 + \text{CO}_2 \rightleftharpoons \text{H}_2\text{O} + \text{CO}$ (“water gas” reaction)

As before, 4 balance equations and

$$K^\ominus = \frac{p_{\text{H}_2\text{O}} p_{\text{CO}}}{p_{\text{H}_2} p_{\text{CO}_2}}$$

is the closing equation.

3.5.2 WITH NO CONCENTRATIONS

In order to estimate NO concentrations, we need also to consider equilibrium of

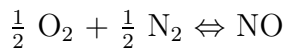

giving an additional

$$K^\ominus = \frac{p_{\text{NO}}}{(p_{\text{H}_2})^{\frac{1}{2}} (p_{\text{CO}_2})^{\frac{1}{2}}}$$

i.e. 6 unknowns to be solved from 6 equations (4 element balance equations, 2 equilibrium equations)

Solution technique: for small concentrations (e.g. of NO) Linear superposition may be approximately adequate. Hence e.g.

- a) solve for case 1-a)
- b) use these values to solve for NO as above.
- c) Repeat 1-a) with $f \neq 0$ and iterate.

3.5.3 EXERCISE

After combustion of a stoichiometric mixture of H_2 and O_2 in a constant volume bomb, the pressure of the products is 10 bar, and 5% of the original H_2 remains uncombined.

- a) Calculate the equilibrium constant K^\ominus for the reaction

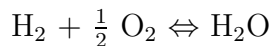

assuming no other species are present.

Hence if the initial temperature was 25°C, find

- b) the temperature after combustion
- c) the initial pressure
- d) the heat transfer from the reaction per kg original H_2

Answers a) 38.5, b) 2844 K, c) 1.53 bar, d) 65 900 kJ.kg⁻¹

3.5.4 EXERCISE

A spark Ignition engine operates with a 10% rich mixture of octane (C_8H_{18}) and air. The exhaust gases leave the engine at a temperature of 1200 K, at which it may be assumed that the only significant species are CO_2 , H_2O , CO , H_2 and N_2 . Calculate the wet exhaust composition if it is also assumed that the following reaction is in equilibrium:



Answers: 11.3% CO₂, 2.04 % CO, 13.3 % H₂O, 1.76% H₂, 71.6% N₂

3.5.5 EXERCISE

In a certain diesel engine cylinder at the end of combustion at maximum load, one quarter of the initially trapped O₂ remains un-reacted, and the mean gas temperature is 2200 K. By assuming equilibrium of the reaction

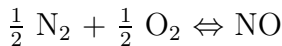

estimate the proportion of the Nitrogen which is converted to NO.

Answers: 0.42%

3.5.6 EXERCISE

- a) A spark ignition engine operates with a 10% rich mixture of carbon monoxide and air. Show that for equilibrium at 3000 K, 40 bar, about 24% of the CO supplied will remain dissociated, if only CO, O₂, N₂, CO₂ are assumed present. Hence calculate the molar gas composition.
- b) If NO is now considered as a possible additional species, show that the dissociated CO rises to about 25.7% of that supplied, and that about 1.2% of the Nitrogen supplied is oxidised. Calculate the new composition.

Answers: a) 27.3% CO₂, 8.7% CO, 2.7% O₂ and 61.5% N₂. b) 26.6% CO₂, 9.2% CO, 2.3% O₂, 60.5% N₂ and 1.4% NO

3.6 Kinetics

The rate at which chemical equilibrium is approached is also dependent on temperature (fast at high temperature, slow at low temperature). Quantitative analysis of this is too complex for this course, but qualitative understanding will be important for

- a) Ignition.
- b) Rate of flame travel.
- c) 'Freezing' during expansion of species formed at high temperature (pollutant emissions).

Chapter 4: Simple physics of flames and combustion

4.1 Premixed laminar flame

In a premixed flame the reactants are well mixed before the flame arrival
The laminar flame front and position are well defined as shown on figure 4.1

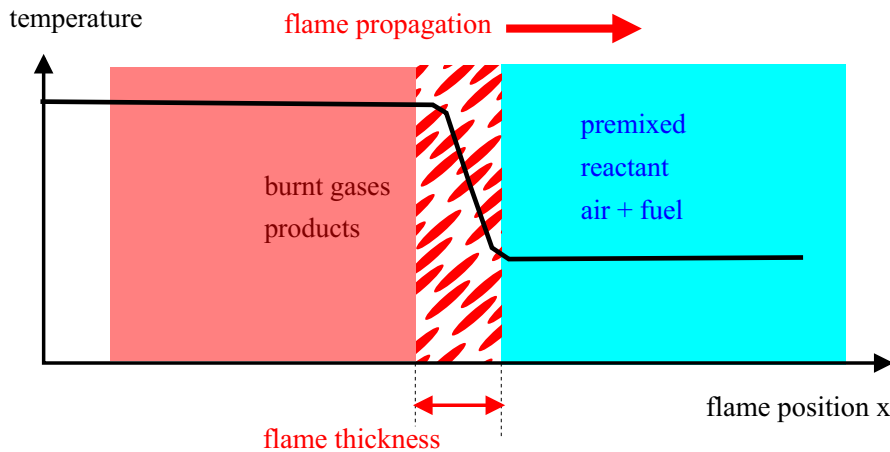

Figure 4.1. Laminar premixed flame

It is then possible from experiment to define the laminar flame speed $s_l = \frac{dx}{dt}$ with dx the distance the flame has moved during a time lag dt . The flame is the result of the equilibrium between three mechanisms

- There are transfer mechanisms within the flame (exchange of heat, products, reactants) through a diffusion process. A characteristic time can be based on the diffusion coefficient κ and the flame thickness δ_l

$$\tau_d = \frac{\delta_l^2}{\kappa}$$

- The flame propagates with a characteristic time based on s_l and δ_l

$$\tau_a = \frac{\delta_l}{s_l}$$

- The reaction is first of all a chemical reaction and as such is also controlled through chemistry with its own characteristic time

$$\tau_{ch}$$

The laminar flame results of the equilibrium between all these mechanisms:

$$\tau_d \simeq \tau_a \simeq \tau_{ch}$$

Any change in one of these mechanism may results in the quenching of the flame.

The laminar speed is a function of ϕ the relative fuel air ratio.

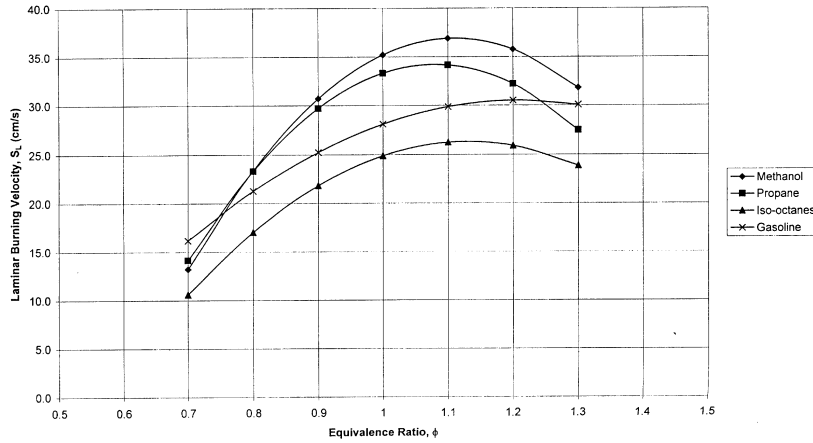

Figure 4.2. Laminar flame speed as a function of ϕ at 1 bar

4.2 Diffusion flame

- There is no mixing of the reactants before the flame front
- fuel gas and oxygen diffuse from opposite sides
- fuel is heated before oxidation and may decompose \rightarrow C particle, radical, smoke, soot.
- the combustion is not controlled by overall ϕ but by mixing

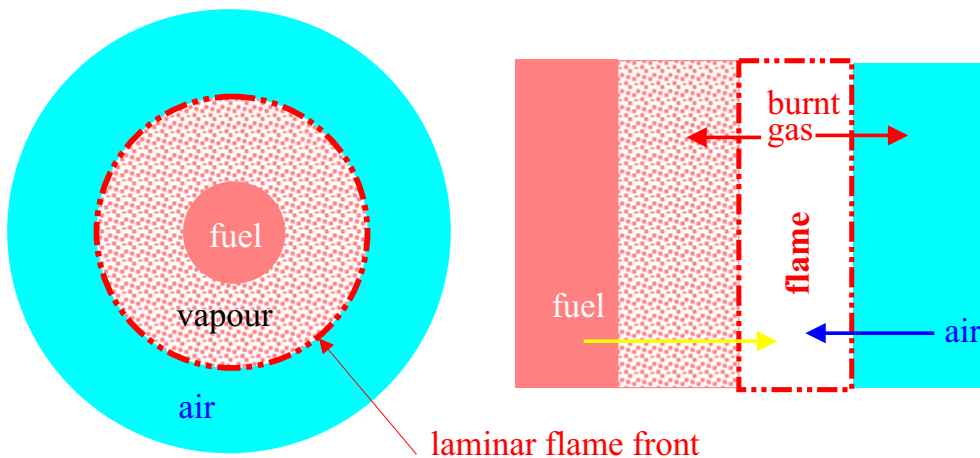

Figure 4.3. Diffusion flame

4.3 Detonation Wave

- A shock wave driven by combustion
- not normally possible in engines

4.4 Ignition in Piston Engine

It is necessary to reach a certain temperature for the mixture to ignite this is the ignition phase. After ignition, the energy released from the combustion will provide the heat necessary to sustain the combustion.

- Spark ignition: high temperature (e.g. 3000 K) source from an electric discharge (spark).
- Compression ignition: spontaneous¹ ignition resulting from high compressed air temperature (e.g. $T = 600$ K).
- Pre-ignition: harmful ignition from hot surface during compression stroke.
- Auto-ignition¹: spontaneous ignition of 'end gas' before arrival of the flame resulting in knock

4.5 Turbulent flame

4.5.1 TURBULENCE PARAMETERS

Turbulence can be characterised by

- a velocity macro-scale u' defined as the rms value of the velocity fluctuations,
- a macro-length scale or integral length scale L corresponding to the size of the largest eddies present in the turbulent, flow
- a micro-length scale or Kolmogorov length scale η_K corresponding to the small eddies present in the flow.

4.5.2 MIXING

The flow into the cylinder is highly turbulent and the mean velocity is often smaller than the turbulent velocity. But by the way air is injected in the cylinder mean flows can also be induced into the cylinder.

¹Time is required to permit initial chain reaction sequence when the flame temperature is low.

- **Tumble:** refers to a rotational flow within the cylinder about an axis orthogonal to the cylinder axis.
- **Swirl:** refers to a rotational flow within the cylinder about its axis. Swirl is used in some gasoline engines to promote a fast burn and is one of two principal means to ensure rapid mixing between fuel and air in direct-injected diesel or stratified charge engines. Diesel engines without swirl are said to be quiescent and the intensity of the fuel injection is instead relied upon to mix the fuel and air. The induction swirl is generated either by tangentially directing the flow into the cylinder or by pre-swirling the incoming flow by use of a helical port.

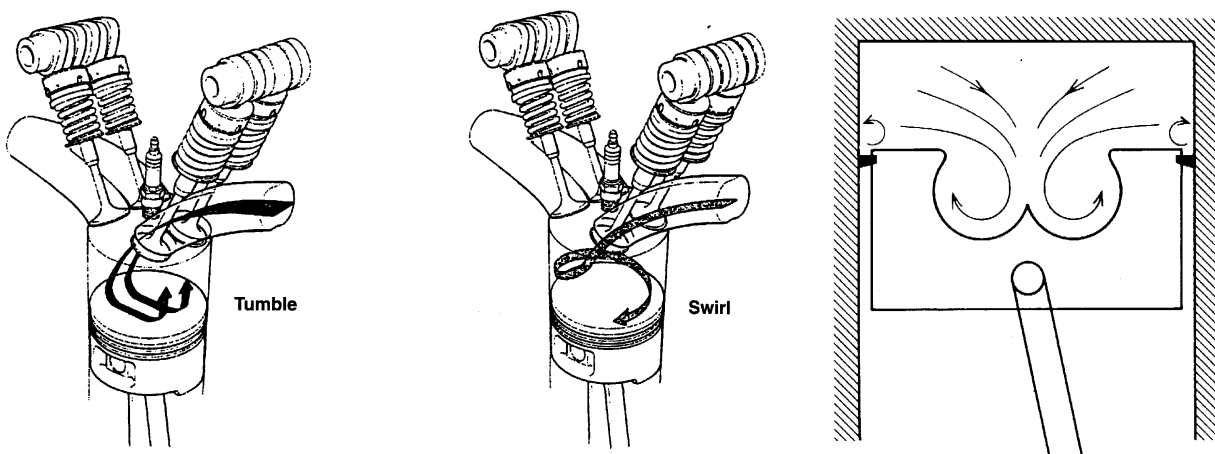

Figure 4.4. Tumble, Swirl and Squish

- **Squish:** is a radial flow most commonly associated with direct-injection engines in which the combustion chamber is a cup located within the piston (e.g. figure 4.4 right). The cup is there to amplify swirl generated during the intake process and squish is a necessary byproduct of using a cup.

In practice it is impossible to generate swirl without inducing some tumble. The swirl level at the end of the compression process is dependent upon the swirl generated during the intake process and how much it is amplified during the compression process.

4.5.3 TURBULENT FLAME FRONT

The first role of turbulence is to increase the mixing of burnt gas with unburnt gas which increases the combustion.

Turbulent flame occurs in turbulent flows, flame front is more complex as in figure 4.5 and flame speed can not be measured directly. An equivalent turbulent speed s_b is calculated based on an average position of the front as in figure 4.6:

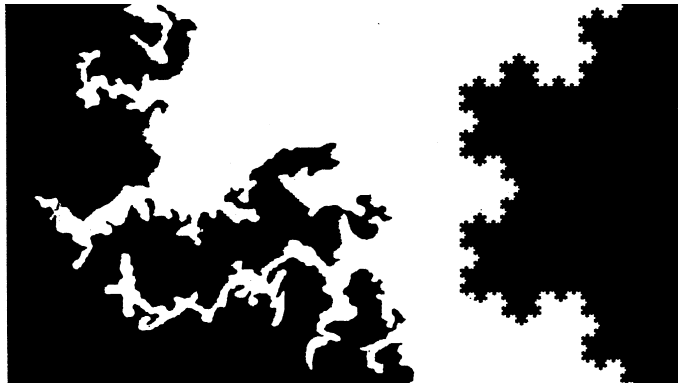

Actual flame compared to the fractal Koch curve by courtesy of Dr D. Queiros-Conde

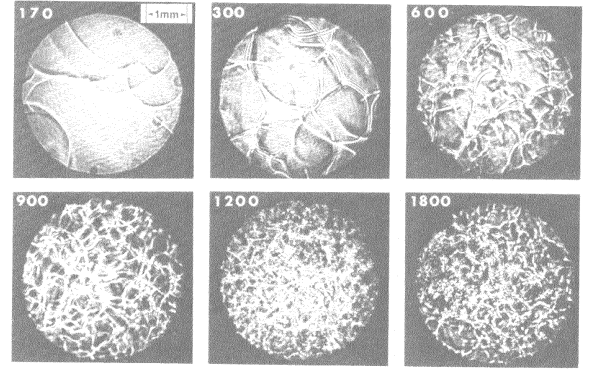

Figure 7-39 Microshadowgraphs of flame propagating toward the viewer showing increased wrinkling as engine speed increases. Engine rpm is indicated in the upper left corner of each photo (Smith, 1982).

Flame shape as a function of engine speed from Fergusson (1986)

Figure 4.5. Flame shape in a turbulent flow

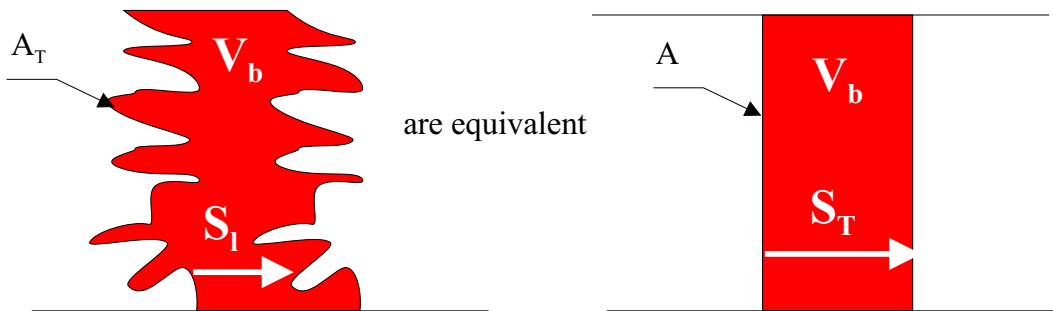

Figure 4.6. Turbulent velocity definition

and mass conservation yields

$$\dot{m} = \rho_u s_l A_T = \bar{\rho}_u s_T A$$

that is

$$s_T = s_l \frac{A_T}{A}$$

(4.1)

Typically:

$$3 < \frac{s_T}{s_l} < 30$$

Models have been proposed for

$$s_T = s_T(u', L, s_l, \delta_l)$$

for small scale turbulence

$$s_T \simeq s_l \left(\frac{u'}{s_l} \right)^{\frac{1}{2}}$$

For large scale turbulence, the apparent fractal geometry of the flame surface leads to (see Nicolleau & Mathieu (1994), Nicolleau (1994))

$$s_T \sim u'$$

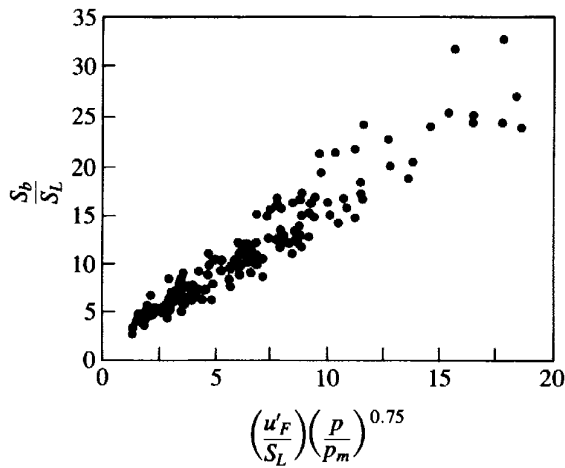

(see Heywood, 1988, figure 9-30 p. 412)
 The ratio p/p_m corrects for the effects of additional compression on the turbulence intensity

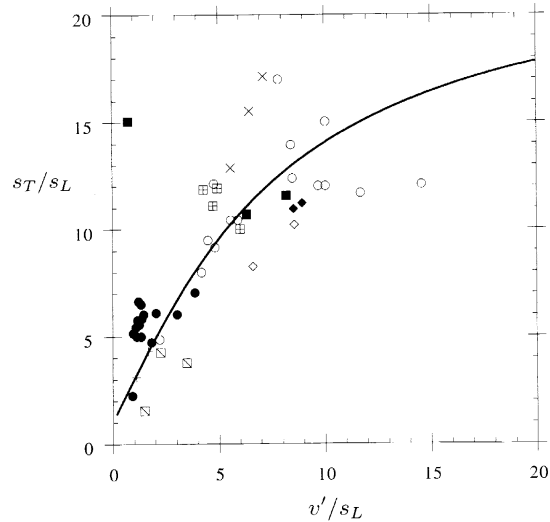

(see Peters, 2000, figure 2.22 p. 124)

Figure 4.7. Turbulent flame compared to laminar flame

4.6 Flame Quench

Turbulence also stretches the flame front which can lead to quenching.

A flame may be extinguished

- a) near a cold wall
 - harmful because unburnt HC remain
 - may be necessary to prevent knock
- b) In a region where ϕ is too small (e.g. $\phi = 0.5$)
 - Uneven fuel/aire mixing
 - stratified charge design

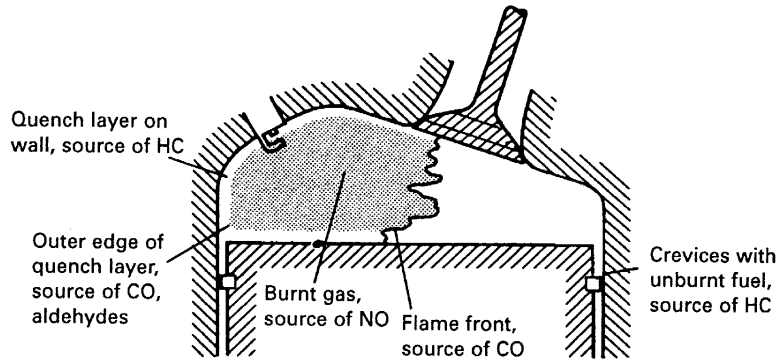

From Stone (1999)
Figure 3.19 page 100

Figure 4.8. Quenching near the walls

4.7 Diesel combustion

Diesel combustion is a diffusion flame reaction

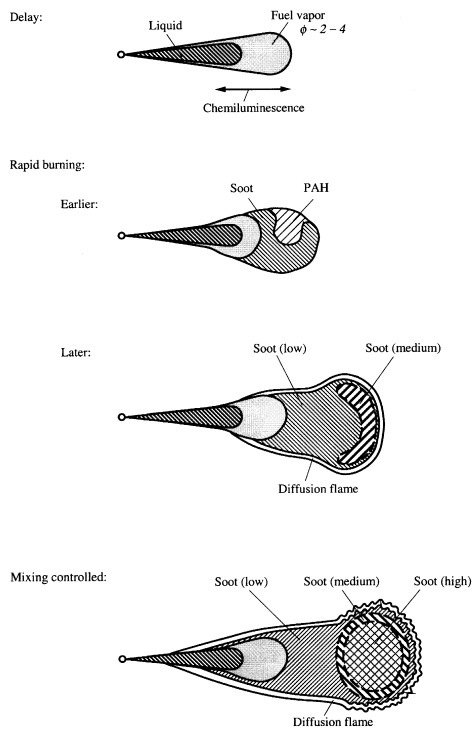

Figure 6-28 Schematics illustrating critical processes and regions of a diesel fuel spray during the delay period, rapid (premixed) burning, and mixing-controlled burning phases of phenomenological diesel combustion model (based on Dec²⁷).

Figure 4.9. Diesel fuel spray combustion

From Heywood & Sher (1999) and Flynn *et al.* (1999)

Appendix of chapter 4

4.A Bunsen burner

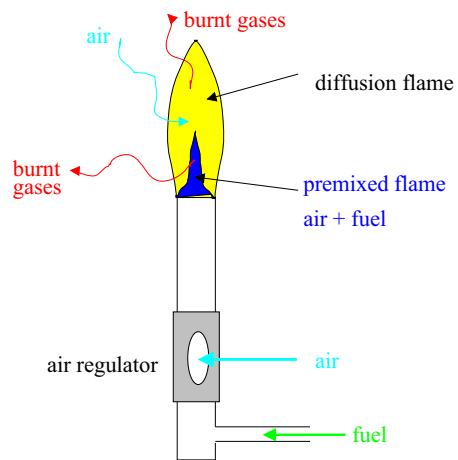

Figure 4.10. Bunsen burner showing premixed and diffusion flames

4.B Turbulent flame propagation

4.C Role of the Swirl

Chapter 5: Equations for reactive flows

5.1 Mass conservation of a passive scalar

We define $\rho(x, y, z; t)$ the local instantaneous density

In classical thermodynamics mass cannot be created, destroyed or altered in something else. The only possibility to change the mass M_V inside a given control volume is either

- to add mass to the system or
- to remove mass from the system.

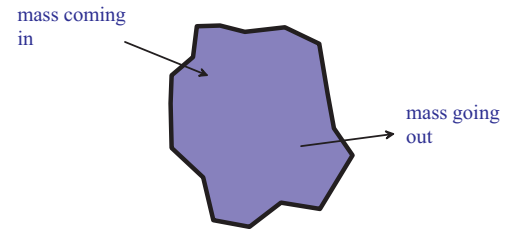

Figure 5.1. Mass flux through the surface

That is, the mass variation per unit time inside the control volume between a time t and a time $t + dt$ is

$$\dot{M}_V = \frac{M_V(t+dt) - M_V(t)}{dt} = \frac{1}{dt} (\text{total mass entering the system during } dt - \text{total mass leaving the system during } dt) \quad (5.1)$$

5.1.1 MASS VARIATION INSIDE A CONTROL VOLUME

The mass inside the control volume at time t is

$$M_V(t) = \int \int \int_V \rho(x, y, z; t) dx dy dz$$

and at time $t + dt$

$$M_V(t + dt) = \int \int \int_V \rho(x, y, z; t + dt) dx dy dz$$

so that the mass variation in the control volume is

$$\frac{dM_V}{dt} = \int \int \int_V \lim_{dt \rightarrow 0} \frac{\rho(x, y, z; t + dt) - \rho(x, y, z; t)}{dt} dx dy dz$$

that is

$$\frac{dM_V}{dt} = \int \int \int_V \frac{\partial \rho}{\partial t} dx dy dz \quad (5.2)$$

Note that on the left hand side there is a total derivative as M_V is only a function of time, whereas on the right hand side it is a partial derivative of ρ that is involved as this latter is a function of space and time.

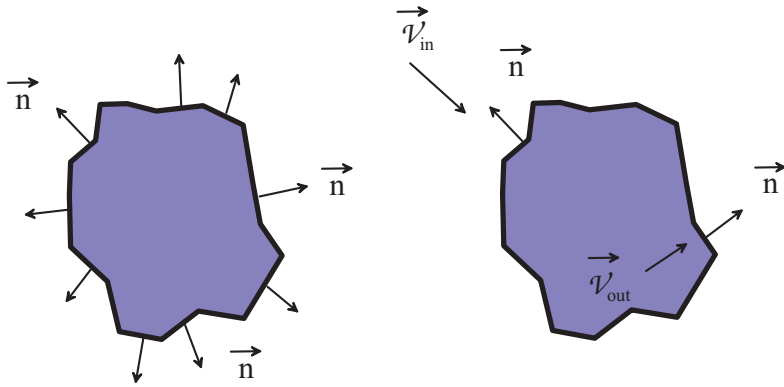

Figure 5.2. External normal convention

5.1.2 THE NOTION OF FLUX

The control volume is bounded by a surface and we can define, \vec{n} , the external surface normal. It is a vector normal to the surface and pointing to the exterior of the control volume.

\vec{v} is the matter velocity when it crosses the control surface, then if

- $\vec{v} \cdot \vec{n} > 0$ the matter is leaving the control volume, whereas if
- $\vec{v} \cdot \vec{n} < 0$ the matter is entering the control volume.

So that, for instance, the total budget of mass transfer during dt through the surface can be formalised as

$$M_i - M_o = - \int \int_{\Sigma} \rho \vec{v} \cdot \vec{n} d\sigma dt$$

(5.3)

and there is no need to discriminate between what is entering and what is leaving the control volume anymore as this is taken into account by the sign of $\vec{v} \cdot \vec{n}$. Note the minus sign, because when matter is entering the control volume it is flowing in the direction opposite to the external normal.

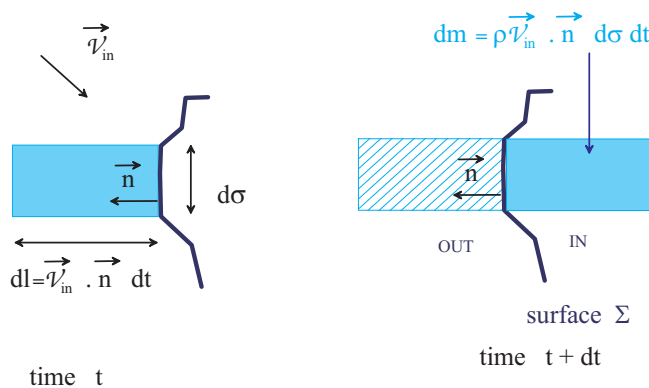

Figure 5.3. Mass flux through an elementary surface $d\sigma$

The quantity $\rho \vec{\mathcal{V}} \cdot \vec{n}$ is called the mass flux.

As shown in figure 5.3, $\rho \vec{\mathcal{V}} \cdot \vec{n} d\sigma dt$ is the elementary element of matter entering the control volume through the elementary surface $d\sigma$.

The same approach is valid for measuring any thermodynamics quantity entering the control volume. Hence we can define

$$\begin{aligned} \rho (\vec{\mathcal{V}} \cdot \vec{n}) & \quad \text{mass flow rate,} \\ \rho u (\vec{\mathcal{V}} \cdot \vec{n}) & \quad \text{internal energy flow rate,} \\ \rho h (\vec{\mathcal{V}} \cdot \vec{n}) & \quad \text{enthalpy flow rate,} \\ \rho \vec{V} (\vec{\mathcal{V}} \cdot \vec{n}) & \quad \text{momentum flow rate,} \\ \frac{1}{2} \rho \mathcal{V}^2 (\vec{\mathcal{V}} \cdot \vec{n}) & \quad \text{kinetic energy flow rate ...} \end{aligned}$$

5.1.3 THE DIVERGENCE THEOREM

(For more on the divergence theorem see e.g. Boas, 2005, §10)

There are some cases where it is more interesting to perform an integral over a volume than over a surface. In some cases we may end up with a mixture of surface and volume integrals. So, it would be useful to convert a surface integral into a volume integral. The divergence theorem allows one to perform such a transformation.

The divergence theorem is explicated in figure 5.4, where $\text{div}(\vec{A})$ is called the divergence of \vec{A} and is defined as

$$\text{div} \vec{A} = \frac{\partial A_x}{\partial x} + \frac{\partial A_y}{\partial y} + \frac{\partial A_z}{\partial z} \quad (5.5)$$

in cartesian coordinates with $\vec{A} = (A_x, A_y, A_z)$. Note that the definition (5.5) is only valid in cartesian coordinate though the divergence theorem (5.4) is valid in any coordinate system: it is an intrinsic definition.

The interest of the theorem is obvious allowing one to replace a vector based integration into a scalar volume integration. For we have seen that the total mass passing through the control surface is per unit time (5.3)

$$\dot{M}_i - \dot{M}_o = - \int \int_{\Sigma} \rho \vec{\mathcal{V}} \cdot \vec{n} d\sigma$$

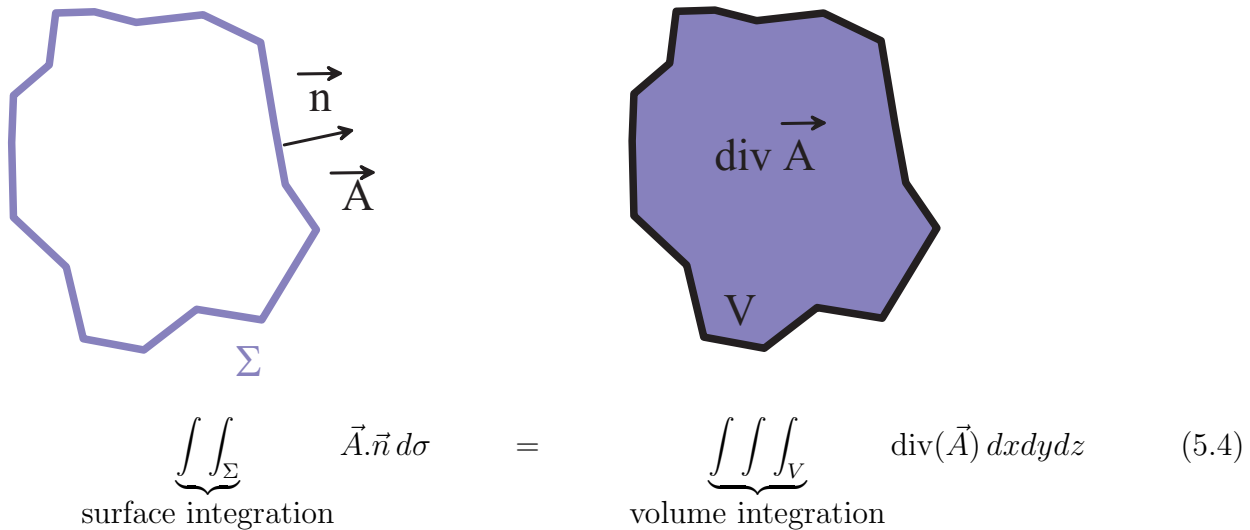

Figure 5.4. The divergence theorem

setting $\vec{A} = \rho \vec{V}$ the divergence theorem yields:

$$\dot{M}_i - \dot{M}_o = - \int \int_{\Sigma} \rho \vec{V} \cdot \vec{n} d\sigma = - \int \int \int_V div(\rho \vec{V}) dxdydz$$

5.1.4 THE CONTINUITY EQUATION

Applying mass conservation (5.2) and (5.3) everything can be expressed in terms of volume integral with no reference to the control surface anymore

$$\int \int \int_V \frac{\partial \rho}{\partial t} dxdydz = - \int \int \int_V div(\rho \vec{V}) dxdydz \tag{5.6}$$

or

$$\int \int \int_V \left[\frac{\partial \rho}{\partial t} + div(\rho \vec{V}) \right] dxdydz = 0 \tag{5.7}$$

This latter equation is true whatever the control volume in particular for any small part of the space, that is for a control volume as small as possible (or $V \rightarrow 0$). So that

$$\frac{\partial \rho}{\partial t} + div(\rho \vec{V}) = 0$$

(5.8)

is true at any time and everywhere. (5.8) is called the continuity equation. It is a local version of the mass conservation. Whatever the mass flow rate, the control surface and volume, equation (5.8) must be verified at each point (x, y, z) of space.

5.2 Un-reactive mixture

In a mixture of different species, further to the global mass conservation (5.8) each species α is conserved and a demonstration similar to the one done in §5.1.4 leads to

$$\frac{\partial \rho_\alpha}{\partial t} + \text{div}(\rho_\alpha \vec{\mathcal{V}}_\alpha) = 0$$

(5.9)

where ρ_α is the density of the α th species:

$$\rho_\alpha = x_\alpha \rho$$

where x_α is the mass fraction of the α th species. Each species has its own density and velocity, the total mass, momentum and energy are

$$m = \sum_\alpha m_\alpha$$

$$\rho \vec{\mathcal{V}} = \sum_\alpha \rho_\alpha \vec{\mathcal{V}}_\alpha$$

$$\rho u = \sum_\alpha \rho_\alpha u_\alpha$$

$$\rho h = \sum_\alpha \rho_\alpha h_\alpha$$

Then, to solve the problem one needs a momentum and energy equation for each species and these equations will be all coupled as species are interacting with each other.

5.2.1 THE SCALAR EQUATION

It is possible to work with x_α rather than m_α , substituting x_α in (5.9) yields:

$$\frac{\partial \rho x_\alpha}{\partial t} + \text{div}(\rho x_\alpha \vec{\mathcal{V}}_\alpha) = 0$$

and after expanding and re-ordering:

$$x_\alpha \left[\frac{\partial \rho}{\partial t} + \text{div}(\rho \vec{\mathcal{V}}_\alpha) \right] + \rho \left[\frac{\partial x_\alpha}{\partial t} + \vec{\text{grad}} x_\alpha \cdot \vec{\mathcal{V}}_\alpha \right] = 0 \quad (5.10)$$

where $\vec{\text{grad}} x_\alpha$ is the gradient of x_α defined in cartesian coordinate as

$$\vec{\text{grad}} x_\alpha = \begin{pmatrix} \frac{\partial x_\alpha}{\partial x} \\ \frac{\partial x_\alpha}{\partial y} \\ \frac{\partial x_\alpha}{\partial z} \end{pmatrix}$$

Then noting that

$$\frac{\partial \rho}{\partial t} + \text{div}(\rho \vec{\mathcal{V}}_\alpha) = \text{div}\{\rho(\vec{\mathcal{V}}_\alpha - \vec{\mathcal{V}})\} \tag{5.11}$$

and

$$\text{div}\{\rho x_\alpha(\vec{\mathcal{V}}_\alpha - \vec{\mathcal{V}})\} = x_\alpha \text{div}\{\rho(\vec{\mathcal{V}}_\alpha - \vec{\mathcal{V}})\} + \rho(\vec{\mathcal{V}}_\alpha - \vec{\mathcal{V}}) \cdot \vec{\text{grad}} x_\alpha$$

on gets

$$\rho \frac{\partial x_\alpha}{\partial t} + \rho \vec{\mathcal{V}} \cdot \vec{\text{grad}} x_\alpha + \text{div}\{\rho x_\alpha(\vec{\mathcal{V}}_\alpha - \vec{\mathcal{V}})\} = 0 \tag{5.12}$$

We can notice that

$$\frac{\partial x_\alpha}{\partial t} + \vec{\mathcal{V}} \cdot \vec{\text{grad}} x_\alpha = \frac{\partial x_\alpha}{\partial t} + \sum_i v_j \cdot \frac{\partial x_\alpha}{\partial x_j} = \frac{dx_\alpha}{dt}$$

$\frac{d(x_\alpha)}{dt}$ is called the particulate or material or total derivative, it is the derivative of the mass fraction x_α along a streamline or following a particle. It is also called Lagrangian derivative.

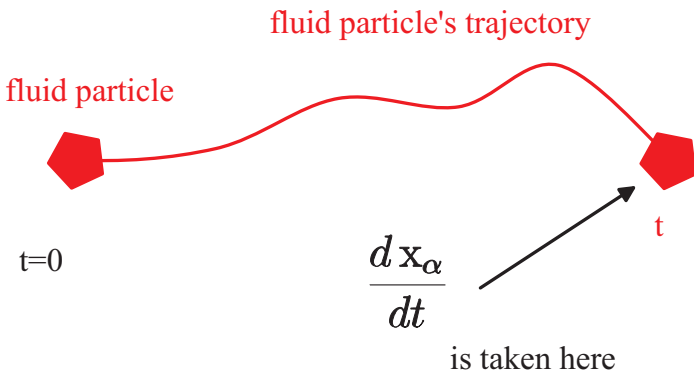

Figure 5.5. Lagrangian derivative. The derivative is taken where the fluid particle is at time t .

So that (5.12) can be written as

$$\rho \frac{dx_\alpha}{dt} + \text{div}\{\rho x_\alpha(\vec{\mathcal{V}}_\alpha - \vec{\mathcal{V}})\} = 0$$

(5.13)

5.2.2 MASS DIFFUSION

If all the species have the same velocity then $\vec{\mathcal{V}}_\alpha = \vec{\mathcal{V}}$ and

$$\frac{dx_\alpha}{dt} = 0$$

That is, the mass fraction of the species does not change along a fluid particle trajectory. In practice, species have different molecular sizes and masses so that there is no reason why they should move at the same speed. For some $\vec{\mathcal{V}}_\alpha > \vec{\mathcal{V}}$, for others $\vec{\mathcal{V}}_\alpha < \vec{\mathcal{V}}$, this is called diffusion. As shown in figure 5.2.2, if for instance $\vec{\mathcal{V}}_\alpha > \vec{\mathcal{V}}_\beta$, the mass fraction of α will increase faster than the mass fraction of β . There will be a diffusion of α in β .

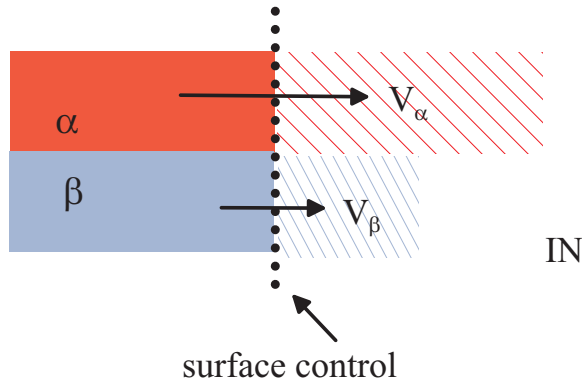

Figure 5.6. Diffusion effect due to $\vec{v}_\alpha > \vec{v}_\beta$.

$$\text{div}\{\rho_\alpha(\vec{v}_\alpha - \vec{v})\}$$

is the diffusion term that accounts for that effect.

$$\vec{\Phi}_\alpha = \rho_\alpha(\vec{v}_\alpha - \vec{v})$$

(5.14)

is **the flux of α** and is proportional to its velocity departure from the mean velocity.

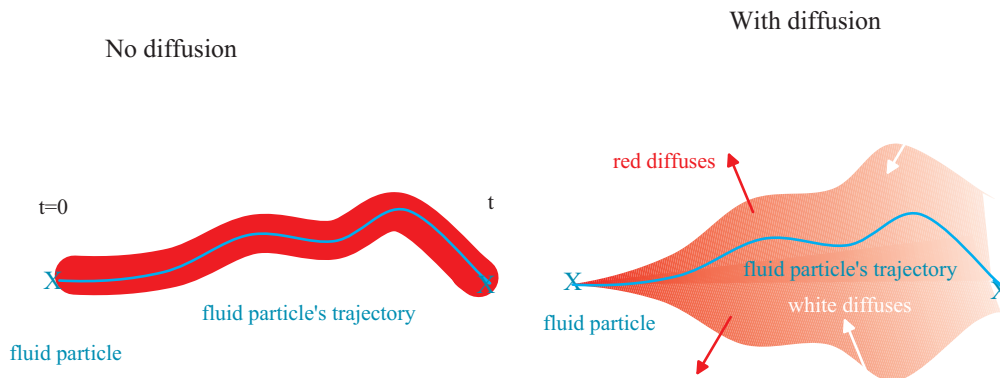

Figure 5.7. Diffusion effect. On the left, there is no diffusion: the mass fraction of red remains constant on the fluid particle's trajectory. On the right, red and white species diffuse and their mass fractions change along the fluid particle's trajectory.

It is worth noting that the sum of all fluxes is 0:

$$\sum \vec{\Phi}_\alpha = 0$$

(5.15)

5.2.3 THE FICK LAW

The Fick law states that

$$\vec{\Phi}_\alpha = -\rho D_\alpha \text{grad}(x_\alpha)$$

(5.16)

where $D_\alpha > 0$ is the mass diffusivity for the species α (in $\text{m}^2 \text{s}^{-1}$). It represents how fast the mass of α diffuses through the other species. Equation (5.16) is the definition we will use in these course. It is worth noting that there is another one which is

$$\vec{\Phi}_\alpha = -D_\alpha^* \text{grad}(\rho x_\alpha) \tag{5.17}$$

Both definitions are not equivalent and it is worth checking which one is used in a textbook. They are equivalent only when ρ is homogeneous, otherwise (5.17) yields

$$D_\alpha^* \text{grad}(\rho x_\alpha) = D_\alpha^* \rho \text{grad} + D_\alpha^* x_\alpha \text{grad} \rho$$

and there is a extra term $D_\alpha^* x_\alpha \text{grad} \rho$ to account for.

To avoid this extra term people interested with mixture use definition (5.16), which from now on will be what we refer to as the Fick law. The Fick law just states that the species α will diffuse (=be transferred) from where it is highly concentrated toward where it is weakly concentrated. $D > 0$ is the equivalent for concentrations of the zeroth law of thermodynamic. In the case of a one-dimensional problem (5.16) becomes

$$\Phi_\alpha = -\rho D_\alpha \frac{\partial x_\alpha}{\partial x}$$

and the Fick law is the equivalent for concentrations of the Fourier law for heat conduction:

$$q_{\text{cond.}} = -k \frac{\partial T}{\partial x}$$

where k is the thermal conductivity.

The advantage of using Fick's law is that equation (5.13) becomes

$$\rho \frac{dx_\alpha}{dt} - \text{div}(\rho D_\alpha \text{grad}(x_\alpha)) = 0$$

$$(5.18)$$

\vec{V}_α does not appear any more, so that there is no need to solve an equation for each \vec{V}_α anymore. Only \vec{V} is needed and can be obtained from the Navier-Stokes equations. But (5.16) is nothing but a closure and as such an approximation, see exercise 5.2.5 to see limitations of the Fick law. If the flow is homogeneous ρ and D_α do not depend on space and then equation (5.18) can be simplified into

$$\frac{dx_\alpha}{dt} - D_\alpha \nabla^2 x_\alpha = 0$$

$$(5.19)$$

where $\nabla^2 x_\alpha = \frac{\partial^2 x_\alpha}{\partial x^2} + \frac{\partial^2 x_\alpha}{\partial y^2} + \frac{\partial^2 x_\alpha}{\partial z^2}$ is the Laplacian of x_α .

For sake of simplicity it is often assumed that the mass diffusivity D_α is proportional to the thermal diffusivity $k_\alpha/\rho c_p$ ($\text{m}^2 \text{s}^{-1}$):

$$D_\alpha \propto \frac{k_\alpha}{\rho c_p}$$

k_α is the thermal conductivity and c_p the heat capacity. The thermal diffusivity represents how fast heat diffuses through the phase α . The ratio of the thermal diffusivity to the mass diffusivity is called the Lewis number:

$$Le_\alpha = \frac{\frac{k_\alpha}{\rho c_p}}{D_\alpha} = \frac{k_\alpha}{\rho c_p D_\alpha}$$

(5.20)

5.2.4 EXERCISE

Derive equation (5.10) and show (5.11) and (5.12)

5.2.5 EXERCISE

Derive the property (5.15). Then using the property that $\sum x_\alpha = 1$, show that if all the D_α are equal then (5.15) is verified.

Then show that only when all the D_α are equal (5.15) is verified.

5.2.6 EXERCISE

A greasy plate is placed into the water, and a thin film of oil forms on top of the water. Find the flux, J in $\text{mol cm}^2 \text{s}^{-1}$, of oil droplets through the water to the top surface. The sink is 18 cm deep, and the concentration of oil on the plate is 0.1 mol cm^{-3} . Assume that there is no oil at the top of the sink yet.

5.3 Reactive scalar

For a reactive mixture, mass still cannot be created or destroyed and equation (5.8) is still valid. But this is not true of equation (5.9) as a given species can be destroyed or created this is precisely what happens in a chemical reaction.

So that the mass M_α of the species α inside a given control volume can be altered by

- adding mass of α to the system or
- removing mass of α from the system or

- creating or destroying the species α

A term of production needs to be added to (5.9), we define τ_α the specific production rate of α (i.e. in $\text{kg m}^{-3} \text{s}^{-1}$)

$$\rho \frac{d x_\alpha}{dt} - \text{div}(\rho D_\alpha \vec{\text{grad}}(x_\alpha)) = \tau_\alpha \tag{5.21}$$

That is

$$\rho \frac{d x_\alpha}{dt} = \underbrace{\text{div}(\rho D_\alpha \vec{\text{grad}} x_\alpha)}_{\text{diffusion}} + \underbrace{\tau_\alpha}_{\text{production}}$$

5.4 The energy conservation

- As for mass, energy can be altered by transfer or flux of matter. Any matter transferred inside the control volume has a certain energy that will be added to the energy previously contained in the control volume.

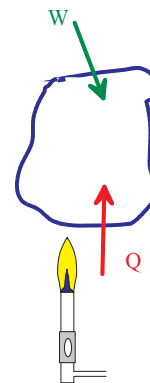
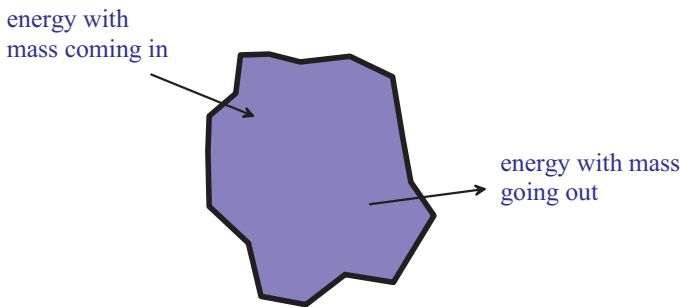

a) Energy entering and leaving the control volume with mass transfer

b) Closed system, 1st law of thermodynamic

Figure 5.8. Altering energy in a control volume

- But by contrast to mass, this is not the only mechanism by which energy can be altered. According to the first of thermodynamic, energy can be altered by adding heat or work to the system; this can be done without matter entering or leaving the control volume.

So that a general formulation of the first law of thermodynamic for an unsteady system is

$$\Delta U = U(t + dt) - U(t) = U_f - U_i = U_{in} - U_{out} + W_{in} + Q_{in} \tag{5.22}$$

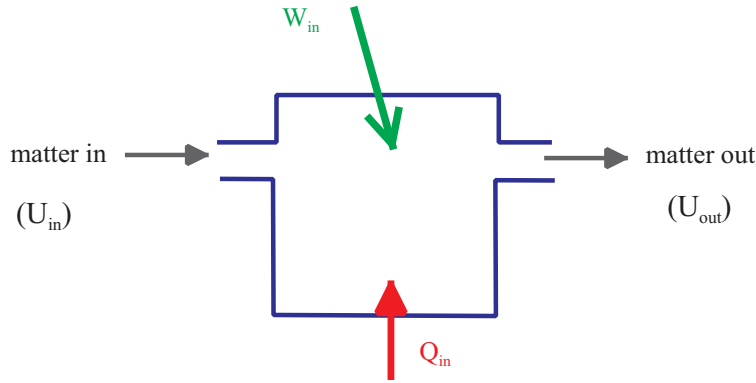

Figure 5.9. Energy conservation in a control volume

where $U_f = U(t + dt)$ and $U_i = U(t)$ are respectively the final and initial state of the system, U_{in} , U_{out} the energy entering and leaving the system due to the mass flow rate of matter through the control surface during dt . W_{in} , Q_{in} are respectively the total work and total heat **received** by the system between the initial and final state (i.e. during the time dt).

The fundamental equation (5.22) can also be written in terms of rate and power, that is in energy per unit time (Watt):

$$\frac{dU}{dt} = \dot{U}_{in} - \dot{U}_{out} + \dot{W}_{in} + \dot{Q}_{in} \quad (5.23)$$

Using u the specific internal energy we have

$$\frac{dU}{dt} = \int \int \int_V \frac{\partial(\rho u)}{\partial t} dx dy dz \quad (5.24)$$

We can also use the flux formalism introduced in § 5.1.2 so that

$$\dot{U}_{in} - \dot{U}_{out} = - \int \int_{\Sigma} \rho u (\vec{\mathcal{V}} \cdot \vec{n}) d\sigma \quad (5.25)$$

which can be transformed into a volume integration using the divergence theorem:

$$\dot{U}_{in} - \dot{U}_{out} = - \int \int \int_V \text{div}(\rho u \vec{\mathcal{V}}) dx dy dz \quad (5.26)$$

So that eventually equation (5.23) yields:

$$\int \int \int_V \frac{\partial(\rho u)}{\partial t} dx dy dz = - \int \int \int_V \text{div}(\rho u \vec{\mathcal{V}}) dx dy dz + \dot{W}_{in} + \dot{Q}_{in} \quad (5.27)$$

5.4.1 ADDING HEAT AND WORK

We can distinguish between heat and work transfer at the control surface such as

- heat transfer

- pressure force on the surface
- shear force on the surface

and internal work and heat production e.g.

- chemical reaction
- potential energy variation due to body force as gravity

As we did before we can define fluxes and use the divergence theorem to replace what happens at the surface with something that can be computed in the volume.

- The heat flux \vec{q}_σ is defined as the surface density of heat transferred at the surface in a certain direction. Its unit is $J\ m^{-2}$.

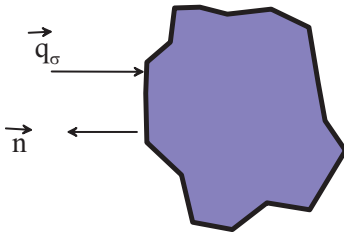

Figure 5.10. Heat flux

The total amount of heat transferred to the system through the surface during dt is

$$Q_\Sigma = - \int \int_\Sigma \vec{q}_\sigma \cdot \vec{n} d\sigma = \int \int \int_V \text{div} \vec{q}_\sigma \, dx dy dz$$

or in terms of heat flow rates:

$$\dot{Q}_\Sigma = - \int \int_\Sigma \left(\frac{\partial}{\partial t} \vec{q}_\sigma \right) \cdot \vec{n} d\sigma = - \int \int \int_V \text{div} \left(\frac{\partial}{\partial t} \vec{q}_\sigma \right) \, dx dy dz$$

(5.28)

where \dot{Q}_Σ is the total amount of heat *rate* transferred to the system through the surface, its unit is W; $\frac{\partial}{\partial t} \vec{q}_\sigma$ is the heat flux rate, its unit is $W\ m^{-2}$.

- The pressure applied to a fluid particle in motion results in a work. The elementary power due to the pressure applied over a small portion $d\sigma$ of the surface is

$$\delta \dot{W}_{pressure} = \underbrace{p d\sigma \vec{n}}_{\text{pressure force}} \cdot \vec{v} \tag{5.29}$$

where $\vec{\mathcal{V}}$ is the fluid particle's velocity when it crosses the control surface. Note also that $d\sigma \vec{n} \cdot \vec{\mathcal{V}} dt = dV$, the volume variation, so that (5.29) is just another form of the pressure work $W = -pdV$. Therefore, the total power over the whole surface due to pressure is

$$\dot{W}_{pressure} = - \int \int_{\Sigma} p \vec{\mathcal{V}} \cdot \vec{n} d\sigma = - \int \int \int_V \text{div}(p \vec{\mathcal{V}}) dx dy dz \quad (5.30)$$

- In general the force applied on the surface can be decomposed into a normal component (pressure) and a tangential component (shear force):

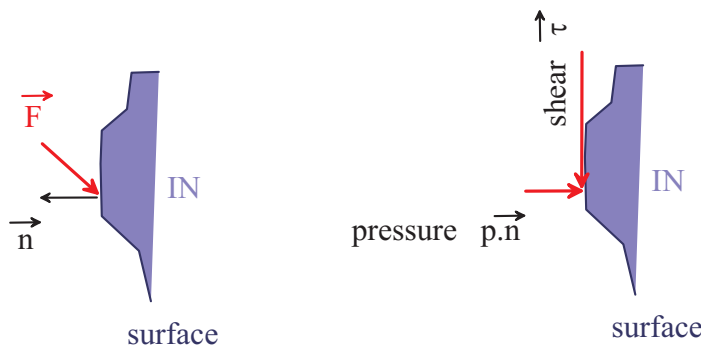

Figure 5.11. Shear and pressure forces

The shear force direction is orthogonal to the normal \vec{n} so that it can be modelled as

$$\vec{\tau} = \bar{\bar{\tau}} \cdot \vec{n} \quad (5.31)$$

where $\bar{\bar{\tau}}$ is the stress tensor. With this formalism the divergence theorem yields

$$\dot{W}_{shear} = - \int \int_{\Sigma} (\bar{\bar{\tau}} \cdot \vec{n}) \cdot \vec{\mathcal{V}} d\sigma = - \int \int \int_V \text{div}(\bar{\bar{\tau}} \cdot \vec{\mathcal{V}}) dx dy dz \quad (5.32)$$

5.4.2 VOLUME FORCE

A typical volume force or body force, \vec{F}_b , is the weight, for an elementary volume $dV = dx dy dz$

$$\vec{F}_b = dm \vec{g} = \rho dV \vec{g}$$

It does not depend on the surface and applies at any point inside the control volume. The power of the body force is then given by

$$\dot{W}_b = \int \int \int_V \vec{F}_b \cdot \vec{\mathcal{V}} dx dy dz$$

that is for gravity

$$\dot{W}_b = \int \int \int_V \rho \vec{g} \cdot \vec{\mathcal{V}} \, dx dy dz \tag{5.33}$$

5.4.3 HEAT PRODUCTION

Similarly, we can define a volume heat power, this would typically be a chemical reaction or radiation. If a chemical reaction is occurring in the control volume, from a thermodynamic point of view this results in a heat power production everywhere in the control volume:

$$\underbrace{\dot{Q}_{prod}}_{\substack{\text{Total heat produced} \\ \text{in the volume} \\ \text{per unit time (W)}}} = \int \int \int_V \underbrace{\dot{q}_{prod}}_{\substack{\text{local} \\ \text{heat production rate} \\ \text{(W m}^{-3}\text{)}}} \, dx dy dz \tag{5.34}$$

5.4.4 THE ENERGY BALANCE

Having described the different contributions to \dot{W}_{in} and \dot{Q}_{in} we can now explicit equation (5.27):

$$\begin{aligned} \int \int \int_V \frac{\partial(\rho u)}{\partial t} \, dx dy dz &= - \int \int \int_V \text{div}(\rho u \vec{\mathcal{V}}) \, dx dy dz && \text{due to matters entering the control volume} \\ &- \int \int \int_V \text{div}(p \vec{\mathcal{V}}) \, dx dy dz && \text{pressure work on the surface} \\ &+ \int \int \int_V \text{div}(\vec{\tau} \vec{\mathcal{V}}) \, dx dy dz && \text{shear force on the surface} \\ &+ \int \int \int_V \rho(\vec{g} \cdot \vec{\mathcal{V}}) \, dx dy dz && \text{volume force (weight)} \\ &- \int \int \int_V \text{div}(\vec{q}) \, dx dy dz && \text{heat transfer at the surface} \\ &+ \int \int \int_V \dot{q}_{prod} \, dx dy dz && \text{heat produced in the volume} \end{aligned} \tag{5.35}$$

Which leads to the local internal energy equation:

$$\boxed{\frac{\partial(\rho u)}{\partial t} + \text{div}(\rho u \cdot \vec{\mathcal{V}}) = -\text{div}(p \cdot \vec{\mathcal{V}}) + \rho(\vec{g} \cdot \vec{\mathcal{V}}) + \text{div}(\vec{\tau} \cdot \vec{\mathcal{V}}) - \text{div}(\dot{\vec{q}}) + \dot{q}_{prod}}$$
(5.36)

5.4.5 ENTHALPY CONSERVATION

Engineers are more interested in the net work when the decanting energy has been removed from W_{net} . This can be obtained from the enthalpy definition:

$$h = u + pv = u + \frac{p}{\rho}$$

so that equation (5.36) becomes

$$\frac{\partial}{\partial t} \left(\rho \left(u + \frac{p}{\rho} \right) \right) + \text{div}(\rho u \cdot \vec{\mathcal{V}}) + \text{div}(\rho \frac{p}{\rho} \cdot \vec{\mathcal{V}}) = \frac{\partial p}{\partial t} + \rho(\vec{g} \cdot \vec{\mathcal{V}}) + \text{div}(\vec{\tau} \cdot \vec{\mathcal{V}}) - \text{div}(\dot{\vec{q}}) + \dot{q}_{prod}$$

that is

$$\boxed{\frac{\partial}{\partial t}(\rho h) + \text{div}(\rho h \cdot \vec{\mathcal{V}}) = \frac{\partial p}{\partial t} + \rho(\vec{g} \cdot \vec{\mathcal{V}}) + \text{div}(\vec{\tau} \cdot \vec{\mathcal{V}}) - \text{div}(\dot{\vec{q}}) + \dot{q}_{prod}}$$
(5.37)

or using property (5.4.7)

$$\rho \frac{d}{dt} h = \frac{\partial p}{\partial t} + \rho(\vec{g} \cdot \vec{\mathcal{V}}) + \text{div}(\vec{\tau} \cdot \vec{\mathcal{V}}) - \text{div}(\dot{\vec{q}}) + \dot{q}_{prod}$$
(5.38)

5.4.6 TOTAL ENTHALPY

If compared to the enthalpy h , the kinetic energy is significant it has to be accounted for and it is

$$\rho \left(h + \frac{1}{2} \mathcal{V}^2 \right) = \text{total enthalpy}$$

that is conserved. The demonstration can be conducted with $\rho \left(h + \frac{1}{2} \mathcal{V}^2 \right)$ instead of h this leads to the total-enthalpy local equation:

$$\frac{d}{dt} \left(\rho \left(h + \frac{1}{2} \mathcal{V}^2 \right) \right) = \frac{\partial p}{\partial t} + \rho(\vec{g} \cdot \vec{\mathcal{V}}) + \text{div}(\vec{\tau} \cdot \vec{\mathcal{V}}) - \text{div}(\dot{\vec{q}}) + \dot{q}_{prod}$$
(5.39)

5.4.7 EXERCISE

Show that

$$\frac{\partial}{\partial t}(\rho A) + \text{div}(\rho A \cdot \vec{\mathcal{V}}) = \rho \frac{\partial A}{\partial t} + \rho \vec{\mathcal{V}} \cdot \vec{grad} A = \rho \frac{dA}{dt}$$

where A is a scalar function.

5.5 Energy equation for a reacting mixture

In the case of a mixture the enthalpy of the mixture is defined as

$$h = \sum \rho_\alpha h_\alpha$$

the momentum of the mixture is

$$\rho \vec{v} = \sum \rho_\alpha \vec{v}_\alpha$$

but

$$\rho h \cdot \vec{v} \neq \rho_\alpha h_\alpha \cdot \vec{v}_\alpha$$

because this flux describes the transfer on a surface and is not an extensive or additive quantity.

5.5.1 EXERCISE

Prove that

$$\rho h \cdot \vec{v} \neq \rho_\alpha h_\alpha \cdot \vec{v}_\alpha$$

5.5.2 ENERGY CONSERVATION FOR A MIXTURE

Hence it is safer to work on the basics energy conservation principle (5.23):

$$\frac{dU}{dt} = \dot{U}_{in} - \dot{U}_{out} + \dot{W}_{in} + \dot{Q}_{in} \quad (5.40)$$

as whether we are dealing with a single phase or a mixture (5.23) holds. There is no need to make special case for $\frac{dU}{dt}$ as U is an extensive quantity, so that for a mixture

$$\frac{dU}{dt} = \sum_\alpha \frac{d}{dt} U_\alpha$$

$\dot{W}_{in}, \dot{Q}_{in}$ can be dealt with as they were before. But $\dot{U}_{in} - \dot{U}_{out}$ needs to be looked at carefully it is now accounting for the flux of each species α moving through the surface that is

$$\dot{U}_{in} - \dot{U}_{out} = - \sum_\alpha \int \int_\Sigma \rho_\alpha u_\alpha (\vec{v}_\alpha \cdot \vec{n}) d\sigma$$

The divergence can still be applied and

$$\dot{U}_{in} - \dot{U}_{out} = - \int \int \int_V \sum_\alpha \text{div}(\rho_\alpha u_\alpha \vec{v}_\alpha) dx dy dz$$

So that equation (5.27) becomes

$$\int \int \int_V \sum_\alpha \frac{\partial(\rho_\alpha u_\alpha)}{\partial t} dx dy dz = - \int \int \int_V \text{div} \sum_\alpha (\rho_\alpha u_\alpha \vec{v}_\alpha) dx dy dz + \dot{W}_{in} + \dot{Q}_{in}$$

\dot{W}_{in} , \dot{Q}_{in} can be replaced by they previous expression which do not involve a break down in different species, so that equation (5.36) which was only valid for a single-phase flow has to be replaced by

$$\frac{\partial}{\partial t} \sum_{\alpha} \rho_{\alpha} u_{\alpha} + \operatorname{div}(\sum_{\alpha} \rho_{\alpha} u_{\alpha} \cdot \vec{\mathcal{V}}_{\alpha}) = -\operatorname{div}(p \cdot \vec{\mathcal{V}}) + \rho(\vec{g} \cdot \vec{\mathcal{V}}) + \operatorname{div}(\vec{\tau} \cdot \vec{\mathcal{V}}) - \operatorname{div}(\dot{q}) + \dot{q}_{prod} \quad (5.41)$$

for a mixture. This latter equation can be re-arranged to get an equation in terms of the total derivative of the specific energy $\frac{d}{dt}u$. First, we can notice that the second term of (5.41) can be re-organised as

$$\operatorname{div}(\rho_{\alpha} u_{\alpha} \cdot \vec{\mathcal{V}}_{\alpha}) = \operatorname{div} \left\{ \rho_{\alpha} u_{\alpha} \cdot (\vec{\mathcal{V}}_{\alpha} + \vec{\mathcal{V}} - \vec{\mathcal{V}}) \right\} = \operatorname{div}(\rho_{\alpha} u_{\alpha} \cdot \vec{\mathcal{V}}) + \operatorname{div}(u_{\alpha} \Phi_{\alpha})$$

where we use (5.14) the definition of the flux of α . So that the left hand side of (5.41) can be re-written as follows

$$\frac{\partial}{\partial t} \sum_{\alpha} \rho_{\alpha} u_{\alpha} + \operatorname{div}(\sum_{\alpha} \rho_{\alpha} u_{\alpha} \cdot \vec{\mathcal{V}}_{\alpha}) = \frac{\partial}{\partial t} \sum_{\alpha} \rho_{\alpha} u_{\alpha} + \operatorname{div}(\sum_{\alpha} \rho_{\alpha} u_{\alpha} \cdot \vec{\mathcal{V}}) + \operatorname{div}(\sum_{\alpha} \alpha u_{\alpha} \Phi_{\alpha})$$

that is

$$\frac{\partial}{\partial t} \sum_{\alpha} \rho_{\alpha} u_{\alpha} + \operatorname{div}(\sum_{\alpha} \rho_{\alpha} u_{\alpha} \cdot \vec{\mathcal{V}}_{\alpha}) = \sum_{\alpha} \left\{ \frac{\partial}{\partial t}(\rho x_{\alpha} u_{\alpha}) + \operatorname{div}(\rho x_{\alpha} u_{\alpha} \cdot \vec{\mathcal{V}}) + \operatorname{div}(u_{\alpha} \Phi_{\alpha}) \right\} \quad (5.42)$$

We can now apply (§5.4.7) to $A = x_{\alpha} u_{\alpha}$:

$$\rho \frac{d}{dt}(x_{\alpha} u_{\alpha}) = \frac{\partial}{\partial t}(\rho x_{\alpha} u_{\alpha}) + \operatorname{div}(\rho x_{\alpha} u_{\alpha} \cdot \vec{\mathcal{V}}) = \rho \frac{\partial}{\partial t}(x_{\alpha} u_{\alpha}) + \rho \vec{\mathcal{V}} \cdot \vec{\operatorname{grad}}(x_{\alpha} u_{\alpha}) \quad (5.43)$$

and use this in (5.42):

$$\frac{\partial}{\partial t} \sum_{\alpha} \rho_{\alpha} u_{\alpha} + \operatorname{div}(\sum_{\alpha} \rho_{\alpha} u_{\alpha} \cdot \vec{\mathcal{V}}_{\alpha}) = \sum_{\alpha} \left\{ \rho \frac{d}{dt}(x_{\alpha} u_{\alpha}) + \operatorname{div}(u_{\alpha} \Phi_{\alpha}) \right\} = \rho \frac{d}{dt} \sum_{\alpha} x_{\alpha} u_{\alpha} + \operatorname{div}(\sum_{\alpha} u_{\alpha} \Phi_{\alpha})$$

Eventually, this leads to the expression for the total energy we were looking for

$$\frac{\partial}{\partial t} \sum_{\alpha} \rho_{\alpha} u_{\alpha} + \operatorname{div}(\sum_{\alpha} \rho_{\alpha} u_{\alpha} \cdot \vec{\mathcal{V}}_{\alpha}) = \rho \frac{d}{dt} u + \operatorname{div}(\sum_{\alpha} u_{\alpha} \Phi_{\alpha})$$

Which can in turn can be substituted in (5.41) to yield

$$\rho \frac{d}{dt} u + \operatorname{div}(\sum_{\alpha} u_{\alpha} \Phi_{\alpha}) = -\operatorname{div}(p \cdot \vec{\mathcal{V}}) + \rho(\vec{g} \cdot \vec{\mathcal{V}}) + \operatorname{div}(\vec{\tau} \cdot \vec{\mathcal{V}}) - \operatorname{div}(\dot{q}) + \dot{q}_{prod} \quad (5.44)$$

or

$$\rho \frac{d}{dt} u = -\operatorname{div}(\dot{q} + \sum_{\alpha} u_{\alpha} \Phi_{\alpha}) - \operatorname{div}(p \cdot \vec{\mathcal{V}}) + \rho(\vec{g} \cdot \vec{\mathcal{V}}) + \operatorname{div}(\vec{\tau} \cdot \vec{\mathcal{V}}) + \dot{q}_{prod}$$

(5.45)

which is the equation for the specific energy u of a mixture of α species. In this equation \dot{q}_{prod} is actually the heat produced by radiation as the chemical energy is accounted for in $u = \sum x_{\alpha} u_{\alpha}$ which is the combination of energies of reactants and products. Radiation is the only heat that can be produced by other mechanisms. For the sake of clarity we will therefore replace \dot{q}_{prod} by \dot{q}_{rad} .

5.5.3 EXERCISE

Show that

$$\rho \frac{d}{dt}(x_\alpha u_\alpha) = \rho \frac{\partial}{\partial t}(x_\alpha u_\alpha) + \rho \vec{\mathcal{V}} \cdot \vec{\text{grad}}(x_\alpha u_\alpha) = \frac{\partial}{\partial t}(\rho x_\alpha u_\alpha) + \text{div}(\rho x_\alpha u_\alpha \cdot \vec{\mathcal{V}})$$

and

$$\frac{d}{dt}(\rho x_\alpha u_\alpha) = \frac{\partial}{\partial t}(\rho x_\alpha u_\alpha) + \vec{\mathcal{V}} \cdot \vec{\text{grad}}(\rho x_\alpha u_\alpha) = \frac{\partial}{\partial t}(\rho x_\alpha u_\alpha) + \text{div}(\rho x_\alpha u_\alpha \cdot \vec{\mathcal{V}}_\alpha)$$

Starting from (5.45) show that the equation for the energy per unit volume can be written as

$$\frac{d}{dt}(\rho u) = -\rho u \text{div} \vec{\mathcal{V}} - \text{div}(\dot{q} + \sum_\alpha u_\alpha \Phi_\alpha) - \text{div}(p \cdot \vec{\mathcal{V}}) + \rho(\bar{g} \cdot \vec{\mathcal{V}}) + \text{div}(\bar{\tau} \cdot \vec{\mathcal{V}}) + \dot{q}_{rad}$$

5.6 Enthalpy conservation for a reactive mixture

We can use the same trick we used in (5.37) with (5.45)

$$\rho \frac{d}{dt}h = \frac{\partial p}{\partial t} - \text{div}(\dot{q} + \sum_\alpha h_\alpha \Phi_\alpha) - \text{div}(p \cdot \vec{\mathcal{V}}) + \rho(\bar{g} \cdot \vec{\mathcal{V}}) + \text{div}(\bar{\tau} \cdot \vec{\mathcal{V}}) + \dot{q}_{rad}$$

(5.46)

which is the equation for the specific enthalpy h of a mixture of α species. Again if the kinetic energy is significant h must be replaced by $h + \frac{1}{2}\mathcal{V}^2$.

5.6.1 EXERCISE

Derive equation (5.46) from (5.45).

5.7 Heat transfer

5.7.1 HEAT TRANSFER THROUGH MASS TRANSFER

It is worth taking some time to understand the term $\sum_\alpha u_\alpha \Phi_\alpha$ in equation (5.45). It is the only additional term to the energy equation obtained for a single phase (5.36). We have seen (figure 5.2.2) that a difference in species' velocity will result in altering the mass fraction of the different species. Now, if the different species have different energies they will alter the energy inside the control volume.

As illustrated in figure 5.7.1, the temperature inside the control volume can be increased by putting more of a warm species than of a cooler species. There is a transfer of energy that is just due to

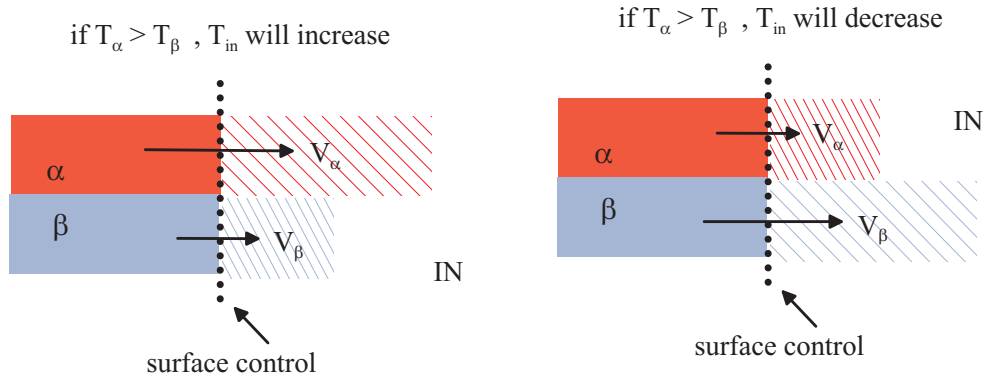

Figure 5.12. Heat transfer due to mass transfer.

the fact that $\vec{V}_\alpha \neq \vec{V}_\beta$. Hence

$$\boxed{\sum_{\alpha} u_{\alpha} \Phi_{\alpha}} \tag{5.47}$$

is the **heat flux associated to a mass transfer**. It is equal to 0 if

- all species have the same velocity, then $\Phi_{\alpha} = 0$,
- all species have the same energy u_{α} (as $\sum \Phi_{\alpha} = 0$).

This term corresponds to a heat transfer and not to a work transfer because it is a 100% irreversible process: once the species are mixed they cannot be unmixed.

5.7.2 MODELLING OF THE TOTAL HEAT TRANSFER

$$\vec{\Psi} = \underbrace{\vec{q}}_{\text{conduction}} + \underbrace{\sum_{\alpha} h_{\alpha} \Phi_{\alpha}}_{\text{heat flux due to mass transfer}} \tag{5.48}$$

is the total heat flux. We can use Fourier's law

$$\vec{q} = -k \text{grad} T$$

and Fick's law

$$\Phi_{\alpha} = -\rho D_{\alpha} \text{grad} x_{\alpha}$$

then

$$\vec{\Psi} = -k \text{grad} T - \sum_{\alpha} \rho D_{\alpha} h_{\alpha} \text{grad} x_{\alpha} \tag{5.49}$$

The Fourier law has introduced the temperature which is not an independent variable as it is linked to the enthalpy. Indeed we have

$$h = \sum_{\alpha} x_{\alpha} h_{\alpha}$$

We can make **the assumption a perfect gas**, that is for each species

$$h_{\alpha} = c_{p\alpha} T$$

where $c_{p\alpha}$ is the specific heat capacity associated to α **and is constant**, then we can calculate c_p as

$$h = c_p T = \sum_{\alpha} x_{\alpha} c_{p\alpha} T \tag{5.50}$$

that is

$$c_p = \sum_{\alpha} x_{\alpha} c_{p\alpha}$$

c_p is not constant but a function of the mass fractions x_{α} . Then from (5.50) we get a simple expression for $\vec{\text{grad}} T$ as a function of h :

$$\vec{\text{grad}} h = \sum_{\alpha} \left\{ T \vec{\text{grad}} (c_{p\alpha} x_{\alpha}) + c_{p\alpha} x_{\alpha} \vec{\text{grad}} T \right\} = c_p \vec{\text{grad}} T + \sum_{\alpha} c_{p\alpha} T \vec{\text{grad}} (x_{\alpha})$$

that is

$$\vec{\text{grad}} T = \frac{1}{c_p} \vec{\text{grad}} h - \sum_{\alpha} \frac{h_{\alpha}}{c_p} \vec{\text{grad}} x_{\alpha}$$

and (5.49) becomes

$$\vec{\Psi} = -\frac{k}{c_p} \vec{\text{grad}} h + \sum_{\alpha} \frac{k h_{\alpha}}{c_p} \vec{\text{grad}} x_{\alpha} - \sum_{\alpha} \rho D_{\alpha} h_{\alpha} \vec{\text{grad}} x_{\alpha}$$

that is:

$$\vec{\Psi} = -\frac{k}{c_p} \vec{\text{grad}} h + \sum_{\alpha} h_{\alpha} \left\{ \frac{k}{c_p} - \rho D_{\alpha} \right\} \vec{\text{grad}} x_{\alpha}$$

(5.51)

or introducing the Lewis number:

$$\vec{\Psi} = -\frac{k}{c_p} \left(\vec{\text{grad}} h - \sum_{\alpha} h_{\alpha} \left\{ 1 - \frac{1}{Le_{\alpha}} \right\} \vec{\text{grad}} x_{\alpha} \right) \tag{5.52}$$

The assumption that $Le_{\alpha} = 1$ is often made, that means that the thermal diffusivity is equal to the mass diffusivity, in other word mass diffuses as fast as heat. Under this assumption

$$\vec{\Psi} = -\frac{k}{c_p} \vec{\text{grad}} h$$

which does not depend on h_α any more and (5.46) becomes

$$\rho \frac{d}{dt} h = \frac{\partial p}{\partial t} + \operatorname{div} \left(\frac{k}{c_p} \vec{\operatorname{grad}} h \right) - \operatorname{div}(p \cdot \vec{\mathcal{V}}) + \rho(\vec{g} \cdot \vec{\mathcal{V}}) + \operatorname{div}(\vec{\tau} \cdot \vec{\mathcal{V}}) + \dot{q}_{rad} \quad (5.53)$$

which does not make explicit references to α any more, but it is worth noting that $c_p = \sum_\alpha x_\alpha c_{p\alpha}$ is not a constant but a function of x_α .

5.8 Momentum equation

The equations we derived for the energy involves the velocity, an equation for the velocity can be derived from the momentum equation.

Momentum $\rho \vec{\mathcal{V}}$

$$\frac{\partial}{\partial t}(\rho \mathcal{V}_i) + \mathcal{V}_j \frac{\partial}{\partial x_j}(\rho \mathcal{V}_i) = \rho F_i - \frac{\partial p}{\partial x_i} + \frac{\partial}{\partial x_j}(\tau_{ij}) \quad (5.54)$$

Please refer for example to MEC404, MEC311 for more on momentum and Navier-Stokes equations.

Revision questionnaire of Part I

- 1) What is the specific fuel consumption sfc ?
- 2) What are the equivalence ratio ϕ , the excess air ratio λ , what do they measure?
- 3) Explain the difference between premixed and diffusion laminar flame
- 4) Explain what are tumble, swirl and squish.
- 5) What are the effects of turbulence in a piston engine?
- 6) What is Fick's law?
- 7) Explain what the Lewis number is.
- 8) Explain the physical meaning of each term in

$$\rho \frac{d x_{\alpha}}{d t} - \operatorname{div}(\rho D_{\alpha} \operatorname{grad}(\rho x_{\alpha})) = \tau_{\alpha}$$

- 9) Explain the physical meaning of

$$\sum_{\alpha} u_{\alpha} \Phi_{\alpha}$$

in the energy balance of a reactive mixture:

$$\rho \frac{d}{d t}(\rho u) = -\operatorname{div}(\dot{\vec{q}} + \sum_{\alpha} u_{\alpha} \Phi_{\alpha}) - \operatorname{div}(p \cdot \vec{\mathcal{V}}) + \rho(\vec{g} \cdot \vec{\mathcal{V}}) + \operatorname{div}(\overline{\vec{\tau}} \cdot \vec{\mathcal{V}}) + \dot{q}_{rad}$$

Part II

Piston engines

Chapter 6: Piston engines

(Cengel & Boles, 1998, §8.3 8.5)

6.1 Performance Parameters for Piston Engines

6.1.1 SWEPT VOLUME

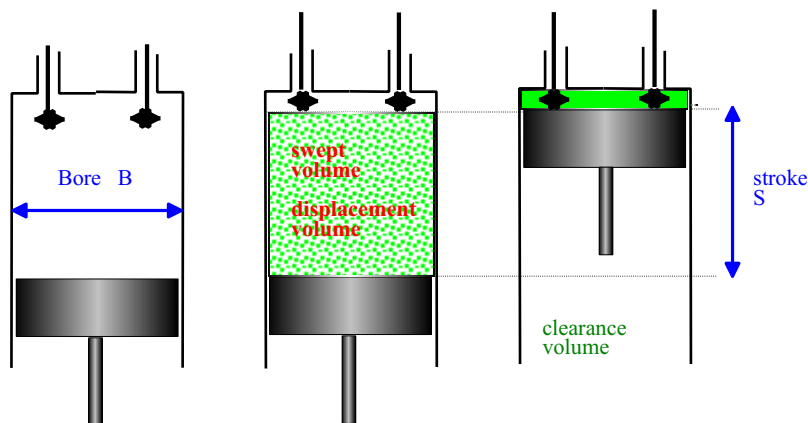

Figure 6.1. Swept volume for one cylinder

For n_c cylinders the swept volume is

$$V_s = n_c \frac{\pi}{4} B^2 S$$

(6.1)

6.1.2 TORQUE

If τ is the crankshaft torque, the work done per revolution (i.e. per two strokes) is

$$W = 2\pi\tau$$

(6.2)

6.1.3 POWER

if the engine rotates at N rev.min⁻¹ the power \dot{W} is

$$\dot{W} = W \times \frac{N}{60} = 2\pi\tau \frac{N}{60}$$

(6.3)

6.1.4 VOLUMETRIC EFFICIENCY, η_{vol}

the volumetric efficiency, η_{vol} , relates the amount of air, trapped in the cylinder when the inlet valve closes (IVC), to the cylinder capacity or Swept Volume, V_s . Although this is in principle a ratio of volumes, it is defined in terms of the mass of air trapped because the volume trapped may contain fuel vapour or products of combustion as well as air, and the pressure and temperature at IVC are probably not known. Hence

$$\boxed{\eta_{vol} = \frac{m_a}{\rho_a V_s}} \quad (6.4)$$

where ρ_a is the air density at the cylinder inlet (or engine intake).

If a complete cycle requires n_s strokes of the piston (2 or 4 stroke), then the air mass flow rate is

$$\dot{m}_a = \eta_{vol} \rho_a V_s \frac{N}{30 n_s} = \alpha \dot{m}_f \quad (6.5)$$

as air is injected every n_s (2 or 4) strokes. So that from (1.1)

$$\dot{W} = \eta_{th} \frac{\eta_{vol} \rho_a}{\alpha} V_s \frac{N}{30 n_s} LCV \quad (6.6)$$

6.2 Mean effective pressure

It is helpful to define several quantities that we will call mean effective pressures.

A mean effective pressure is the constant pressure which, acting on the piston area through the stroke, would produce the observed work per cycle.

This pressure is a fiction, but a useful one. During a real cycle the pressure is only significant during the compression and power strokes. During the compression stroke work is done on the gas in the cylinder, while during the power stroke the gas in the cylinder does work on the piston. Hence, the net pressure would be the difference between these two. The mean effective pressure is therefore the difference between the average pressures on the power and compression strokes.

p_m is an average pressure on the piston so that per cycle

$$W_{cy} = p_m V_s$$

6.2.1 BRAKE MEAN EFFECTIVE PRESSURE p_m

The most common mean effective pressure is the **brake mean effective pressure, bmep or p_{bm}** . The adjective brake refers to measurement at the flywheel. Originally, power output was

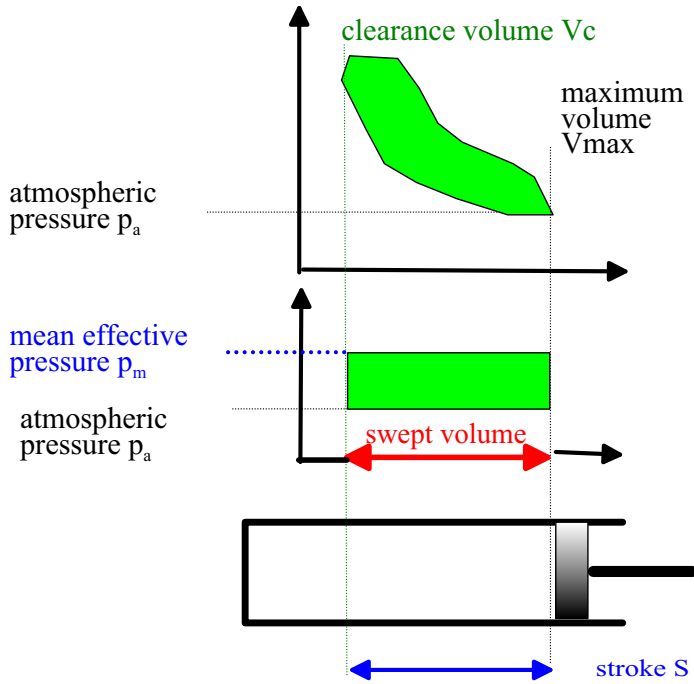

The net work output of a cycle

$$W_{cy} = \int p dv$$

is equivalent to the product of the mean effective pressure p_m and the swept volume

$$W_{cy} = p_m V_s$$

Figure 6.2. Mean effective pressure p_m

measured by applying an ordinary brake to the flywheel, the brake being attached to a long arm, and the moment produced was measured.

Brake power simply means power including the effects of mechanical inefficiency - that is, loss of power to pumping, valve gear, certain accessories and friction.

The work and power from the crankshaft are called **brake** values W_b , and \dot{W}_b . So that per cycle

$$W_b = p_{bm} V_s = n_s \pi \tau$$

where p_{bm} is the **brake mean effective pressure** and so

$$p_{bm} = \frac{n_s \pi \tau}{V_s} \tag{6.7}$$

Also

$$\dot{W} = p_m V_s \frac{N}{30 n_s}$$

(either brake or indicated) and using (6.6):

$$p_m = \eta_{th} \frac{\eta_{vol} \rho_a}{\alpha} LCV$$

p_{bm} is useful because it is roughly comparable even in very different engines, as these different engines burn the same fuel, necessarily under approximately the same conditions, and hence generate similar pressures.

Differences in p_{bm} represent genuine design differences, and not irrelevant differences such as size. p_{bm} is mainly linked to the engine ability to ‘breathe’ - as we will see in chapter 11 - and is in practice limited by present techniques to manage mechanically and thermally with high heat capacities.

6.2.2 INDICATED MEAN EFFECTIVE PRESSURE p_{mi}

A **indicated mean effective pressure** or p_{mi} can also be defined in the cylinder, rather than at the flywheel. It will be referring to the internal or **indicated** work i.e.

$$W_i = p_{mi}V_s$$

By definition p_{mi} does not contain the effects of mechanical friction, or the work necessary to pump the gases in and out and drive the camshaft and various accessories. It consequently will be somewhat higher than the brake value p_{bm} .

6.2.3 MECHANICAL EFFICIENCY

When we consider friction, we can define a **friction mean effective pressure**, or p_{fm} , which is defined using the power expended on friction.

$$p_{bm} = p_m - p_{fm}$$

(6.8)

That is: the brake work (what you actually get) is the difference between the indicated work (what you think you should get) and the frictional losses. This leads to the definition of the mechanical efficiency

$$\eta_{mech} = \frac{W_b}{W_i} = \frac{\dot{W}_b}{\dot{W}_i} = \frac{p_{mb}}{p_{mi}} = \frac{\eta_{thb}}{\eta_{thi}} = \frac{isfc}{bsfc}$$

(6.9)

($\simeq 80\%$ at full load).

6.3 Exercise

a) At full load, an automotive engine running on gasoline (LCV= 44 000 kJ.kg⁻¹) at an air/fuel ratio of 15.0 operates with 35 % brake thermal efficiency and 80 % volumetric efficiency. For air intake conditions of 0.975 bar, 10°C, what are the equivalent brake mean effective pressure and brake specific fuel consumption?

- b) For a 2 litre 4-stroke engine, find the corresponding torque at the flywheel.
- c) For a speed of $3000 \text{ rev.min}^{-1}$, find the brake power.
- d) If the same engine is converted to run on natural gas mixed with the intake air in the ratio 1:10 by volume, estimate the new volumetric efficiency.

answers a) 9.9 bar, $0.234 \text{ kg.kWh}^{-1}$, b) 157 Nm, c) 49.3 kW, d) 73 %

Appendix of chapter 6

6.A Piston engine survey

A 1998-2000 cars - derived from data in Automotive Engineering International (SAE)
and Automotive Engineer (IMechE)

	engine type	swept volume litre	comp. ratio	at maximum power			Max. torque	
				V_p^* m.s ⁻¹	bmpe bar		Nm	bmpe bar
				kW.lit ⁻¹				
Naturally aspirated								
Chrysler Jeep Power Tech	V8 sohc ⁴	4.7	9.3	37.2	13.8	9.3	400	10.7
Ford Mustang	V6 ohv	3.8	9.0	37.5	15.0	8.56	271	9.0
————— GT	V8 dohc	4.8	9.0	35	14.5	8.84	393	10.3
————— SVT Cobra	V8 dohc	4.8	9.85	50	18.3	9.96	427	11.2
GM Opel ECOTEC	IL4 dohc	2.2	9.5	49	18.7	9.9	203	11.6
Toyota 1 SZ-FE VVT	IL4 dohc	0.98	10.0	52.4	13.3	10.5	95	12.2
Alfa Romeo twin spark	IL4 dohc	1.8	10.3	60.7	17.9	11.2	169	12.2
—————	IL4 dohc	2.0	10.0	57.9	19.4	10.85	187	11.9
—————	V6 dohc	2.5	10.3	56.2	14.3	10.7	222	11.2
Jaguar AJ	V6 dohc	3.0	10.5	60.3	18.0	10.7	300	12.7
BMW M5	V8 dohc	4.9	11.0	59.5	19.6	10.8	500	12.7
Renault F5R GDI	IL4 dohc ⁵	2.0		51.5	16?	11.2	200	12.6
Turbocharged								
Ford Endura D1 diesel	IL4sohc	1.8		37.2	11	11.2	200	14.0
Chrysler Jeep diesel	ILS sohc ²	3.1	21	35.8	12.5	10.8	373	15.0
Maserati	V8 dohc	3.2		84.7	16.7	16.3	442	17.4
Audi TT Spark ignition	IL4 dohc ⁵	1.8	8.9	92	15	19.6	280	19.6

B Medium speed (turbocharged and intercooled, max 1000 rev/min - not for cars!)

Alsthom 20RK270	V20 ohv	350	13.3	17.1	10.2	20.6	57400	20.6
-----------------	---------	-----	------	------	------	------	-------	------

ohv overhead valves (i.e. push rod operated)

sohc single overhead camshaft (2 or 4 valves/cylinder)

dohc double overhead camshafts (4 valves/cylinder unless 5 shown)

V_p^* mean piston speed

Chapter 7: Spark ignition engines

7.1 Ideal Otto cycle (Beau de Rochas)

Assume:

- Working fluid is a perfect gas ($pv = RT$, constant c_v and γ)
- Closed system with external heat transfers at constant volume
- Reversible processes, compression and expansion adiabatic.

Otto cycle is composed of four internally reversible processes:

1-2 isentropic compression

2-3 constant volume heat addition

3-4 isentropic expansion

4-1 constant volume heat rejection

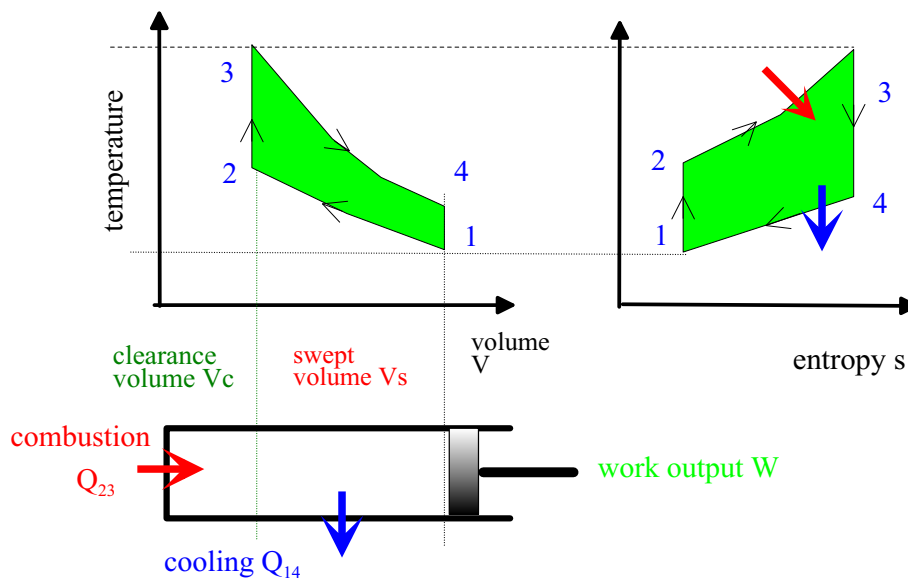

Figure 7.1. Otto Cycle

We can define the **compression ratio** r_v

$$r_v = \frac{V_1}{V_2} = \frac{V_s + V_c}{V_c} = 1 + \frac{V_s}{V_c}$$

(7.1)

For compression (1 - 2) and expansion (3 - 4) processes, the entropy s is constant and hence:

$$\frac{T_2}{T_1} = \left(\frac{V_1}{V_2}\right)^{\gamma-1} = r_v^{\gamma-1} = \left(\frac{V_4}{V_3}\right)^{\gamma-1} = \frac{T_3}{T_4}$$

Net cycle work

$$W_{net} = W_{3-4} + W_{1-2} = U_3 - U_4 + U_1 - U_2 = mc_v(T_3 - T_2 - (T_4 - T_1))$$

Heat input

$$Q_{2-3} = mc_v(T_3 - T_2)$$

Cycle efficiency

$$\eta_c = \frac{W_{net}}{Q_{2-3}} = 1 - \frac{1}{r_v^{\gamma-1}}$$

(7.2)

Hence:

- 1) W_{net} depends on: $m, (T_3 - T_2), r_v, \gamma$
- 2) η_c depends **mainly** on r_v (i.e. mean temperature separation between heating and cooling)

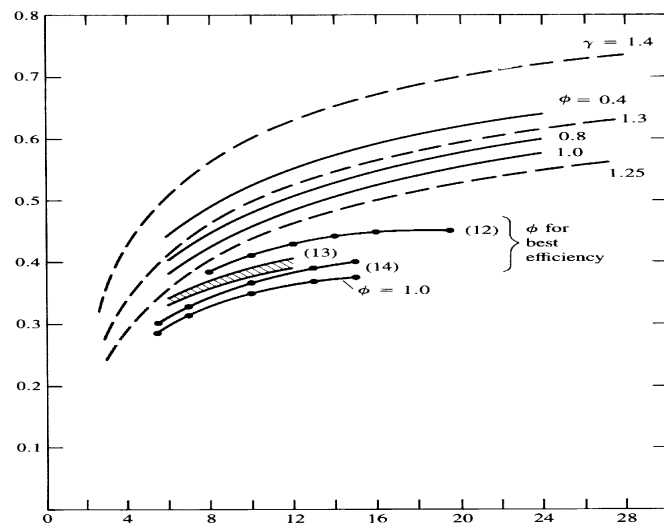

From Heywood (1988) figure 5-19 page 197.

Efficiency η_{th}
 as a function of the compression ratio r_v
 - - - ideal gas constant volume cycle
 - fuel air cycle
 (12), (13), (14) engine data

Figure 7.2. Otto cycle efficiency

7.1.1 EXERCISE

An engine works on the ideal Otto cycle with a compression ratio of 10 and a maximum cycle pressure of 100 bar. The initial conditions are 1 bar, 300K.

- a) Assuming that the working fluid is ideal air ($\gamma = 1.4$, $c_v = 0.7178 \text{ kJ.kg}^{-1}.\text{K}^{-1}$) calculate
- i) The cycle efficiency
 - ii) the maximum gas temperature
 - iii) the heat input required per kg air
 - iv) p , T at the end of the expansion stroke
 - v) the mean effective pressure p_m
- b) Repeat i) and iii) above but use values of γ and c_v for air appropriate to the mean T of the heat input process.
- c) Compare the results of both a) iii) and b) iii) above with the chemical energy available per kg air from combustion of a stoichiometric mixture of octane and air at 298 K.

Answers a) 60.2 %, 3000K, 1612 kJ, 3.98 bar, 1194 K, 11.28 bar, b) 49.9 %, 2142 kJ c) 2964 kJ

7.2 Realistic thermodynamic cycles

7.2.1 EFFECTS OF FUEL-AIR OTTO CYCLE

- a) Non ideal gas: c_p , c_v , γ are not constant but functions of temperature ($\gamma_c \neq \gamma_e$).
- b) Real chemistry effects
 - gas composition changes
 - equilibrium gives effect of ϕ on :

power	(maximum for $1.1 < \phi < 1.2$)
economy	(best for $0.8 < \phi < 0.9$)
- c) Hence magnitudes of mep and cycle efficiency both substantially less than for ideal air Otto cycle

7.2.2 EFFECTS OF DEPARTURE FROM CONSTANT VOLUME

- a) Combustion: flame travel requires finite time.
- b) Gas Exchange: exhaust blow-down and air intake processes benefit from extended periods of valve opening

7.2.3 EFFECTS OF HEAT LOSSES FROM CYLINDER WALLS

7.2.4 COMPARISON WITH ENGINE MEASUREMENTS

7.3 Combustion in spark ignition engines

7.3.1 THE 'NORMAL' COMBUSTION SEQUENCE

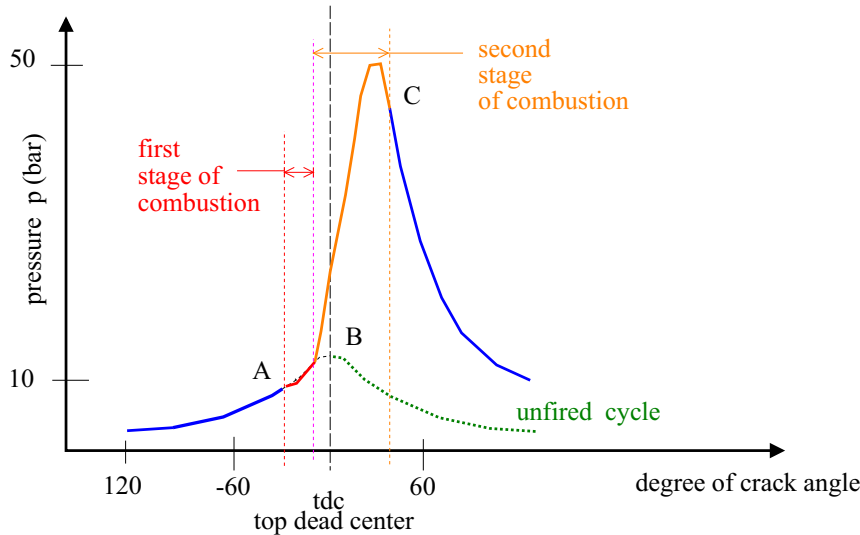

Figure 7.3. Indicator diagram for a spark ignition engine

1. Conditions before combustion

It should be assumed that before ignition the fuel is fully mixed with air and vaporised, and that the fuel/air ratio is within about 30% of the stoichiometric ratio. This mixture will be in a state of turbulent motion, the intensity of which is dependent on the piston speed, and the design of the inlet system and combustion chamber. The microstructure of this turbulence may conveniently be described in terms of a random mesh of vortex filaments, between which the fluid is relatively quiescent. There may also be fluid motion on a larger scale, for example due to swirl, squish or boundary layer roll-up by the piston.

2. Ignition

At the instant of passage of the spark between the electrodes, a very thin tubular thread of flame is created, enveloping the very hot ionised gases formed in the path of the spark. The rate of outward motion of this tubular flame front is initially slow, since in general it will not contact any of the vortex filaments mentioned above. The flame front will therefore travel at a speed conditioned by the temperature gradient and very small flame radius in a mainly laminar manner. It is convenient to specify a 'first stage' of combustion during which this initial tubular flame develops until it has fully interacted with the turbulent microstructure of the mixture, so that an identifiable kernel

of flame is established. Since the proportion of the mixture involved in this stage is negligible, no overall change in cylinder pressure is observable, above that due to piston compression alone.

3. Flame propagation

The interaction of the flame with the fluid turbulence results in very much faster combustion, because both combustion products are rapidly mixed with unburnt fuel and air. The combustion process thus takes place over a thick belt containing pockets of unburnt mixture in a matrix of burning gas. This belt itself propagates progressively through the combustion chamber from the initial kernel. Externally, this belt will however appear as a fairly well defined but rough flame surface, which expands like a convoluted wrinkled balloon. The sharp temperature rise at this flame surface can be detected at any point in the chamber at the instant of its arrival, for example by an ionisation probe or by a suitably placed optical detector.

This process may be regarded as a second stage of combustion, during which the observable pressure rise occurs.

4. Time required

Although there is no physically definable instant at which the first stage terminates and the second stage begins, it is convenient to use the approximate point at which the cylinder pressure curve departs from the equivalent compression curve for this purpose, as indicated by Ricardo (point B in his fig. 1.1). The time required for the first stage is highly dependent on the laminar flame speed and hence on the mixture strength and compression temperature. However it is also dependent on the scale of the turbulent microstructure, and is subject to substantial random variation because the exact positions of vortex filaments relative to the spark cannot be pre-arranged. This time is however net greatly reduced by increased engine speed, so that ignition advance (degrees of crank rotation) must be correspondingly increased at higher speeds.

By contrast the second stage more nearly requires a constant number of degrees of rotation over a wide range of conditions for a given engine. This is because flame propagation depends primarily on the mixing effect of turbulence rather than the laminar flame speed, and the intensity of the turbulence i.e. almost proportional to piston speed for a given design.

7.3.2 EFFECT OF FUEL/AIR RATIO ON IGNITION LIMITS

7.4 Knock in Spark ignition Engines ('Spark Knock', 'Pinking', 'Detonation')

7.4.1 THE PHENOMENON

- Auto-ignition of end gas (i.e. spontaneous ignition before arrival of (flame))

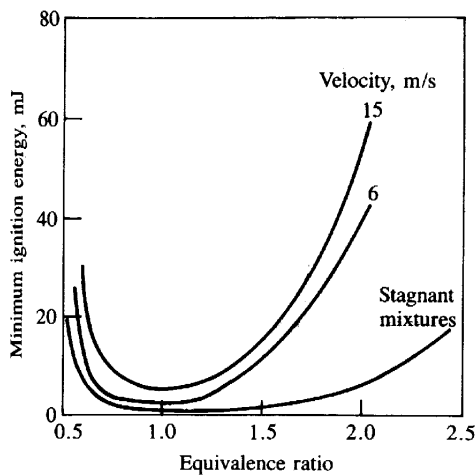

From Heywood (1988)
figure 9.45 page 435.

Figure 7.4. Effect of mixture equivalence ratio ϕ and flow velocity on minimum ignition energy for propane-air mixtures at 0.7 atm

- a result of chain reactions at low temperature in which branching liberates increasing concentrations of key radicals (e.g. H, OH etc)

7.4.2 THE EFFECTS

- Explosive pressure rise from uncontrolled energy release throughout end gas
- shock waves cause: high local stresses, high frequency vibration, high local heat transfer
- piston damage probable: thermal fatigue burning of a leakage channel past piston rings
- worst for low engine speed, high load, early spark, slow main flame, large cylinder.

7.4.3 PREVENTION OF KNOCK

The prevention of knock requires:

- upper limit to compression ratio (to control temperature and pressure of end gas)
- fast flame (e.g. from high turbulence) to minimise time for end gas reactions
- a compact combustion chamber, with minimum of crevices
- high Octane fuel (is hard to ignite at moderate temperatures)

7.4.4 OCTANE NUMBER

Fuel anti-knock quality is specified by its Octane Number:

A standard good fuel is iso-octane tri-methyl pentane:

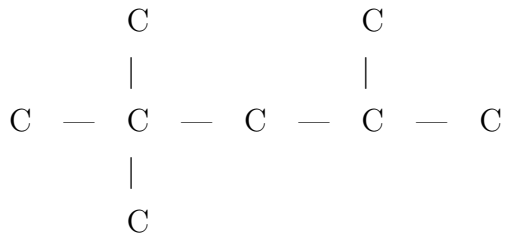

A standard bad fuel is n-heptane

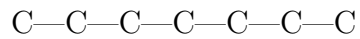

The octane number of a given fuel is obtained by comparing it in a standardised engine test with blends of the above standard fuels. The % iso-octane in that blend which gives the same knock tendency as that fuel under test is then its Octane Number.

High octane fuel either contains compact hydrocarbon molecules (e.g. iso-octane, aromatics), or small amounts of chain breaking additives (e.g. complex oxygenates).

Appendix of chapter 7

7.A Ideal cycle /real cycle comparison

Common conditions: compression ratio $r_v = 10$
 before compression: $p_1 = 1 \text{ bar}, T_1 = 300 \text{ K}$
 after combustion: $p_3 = 100 \text{ bar}, T_3 = 3000 \text{ K}$

Results of ideal cycle predictions for Constant Volume (Otto cycle)

Working Fluid	γ_c	γ_{exh}	$T_4 \text{ K}$	$p_4 \text{ bar}$	ϕ	$\eta_{cy} \%$	$p_m \text{ bar}$
Ideal air	1.4	1.4	1194	4.0	-	60.4	12.5
Real air	1.384	1.295	1522	5.1	-	52.6	14.5
CH4/air*	1.362	1.250	1684	5.6	1.056	747.7	15.5
C8H18/air*	1.33	1.253	1676	75.9	1.014	48.5	16.7

Ideal/real comparison

Fuel-air cycle+	1.33	1.253			1.0	45.9	15.6
<i>Typical S.I. engine:</i>							
full load (indicated)					1.0	37	12.5
full load (brake)					1.0	30	10

* No dissociation, + including dissociation

Chapter 8: Spark ignition engines: combustion control

(p 192 Stone, 1999, §4.6)

8.1 Throttle control

Since $\phi \simeq 1$ is required for adequate combustion, control of load (p_m) or torque requires that the mass of air and fuel mixture be reduced below that for atmospheric density. Hence

- a) Throttle control intake density.
- b) At low load a significant loss occurs
 - pressure drop across the throttle is irreversible
 - negative pumping loop on p - V diagram.

8.2 Fuel Supply

Fuel supply must be arranged to give

- a) $\phi \simeq 1$ at all conditions
- b) good distribution and evaporation of liquid.

The air/fuel mixture can be prepared by either a carburettor or a fuel injection system. In both cases fuel will be present in the inlet manifold as vapour, liquid droplets and a liquid film. Although emissions legislation is now reducing the scope for using carburettors (§8.2.1), their use is still widespread.

There are two types of fuel injection system used on spark ignition engine, multi-point injection (§8.2.3) and single-point injection (§8.2.2).

8.2.1 CARBURETTOR

Carburettor relies on Venturi principle to meter fuel in proportion to air flow (see Stone, 1999, figures 4.40 onwards). The carburetor has a narrowed throat (or Venturi) in which the speed of the air entering the engine increases, causing the pressure to drop ($p_V < p_0$). The pressure drop

between this point and the atmosphere causes the fuel to flow from the float chamber of the carburetor into the air stream. The fuel entering the air stream enters as liquid droplets.

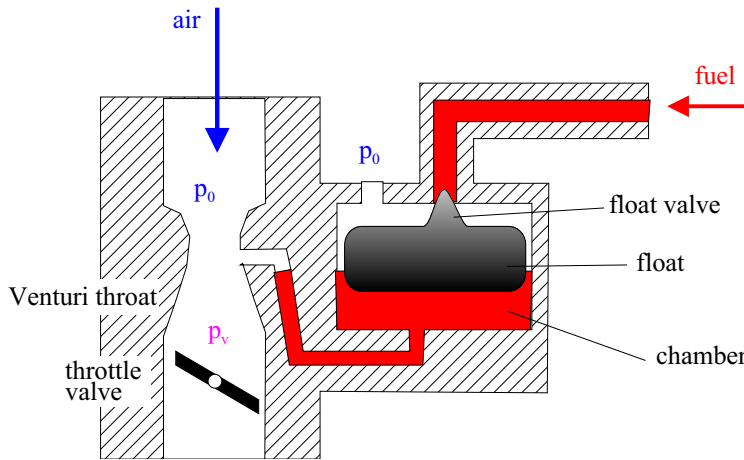

Figure 8.1. Carburettor

The mass of fuel entering must be controlled so that it is proportional to the mass of air flowing through the venturi. In addition, the droplet size must be controlled, the droplets must be encouraged to evaporate, the resulting vapour must be mixed uniformly with the air, and some source of heat must be provided to prevent the cooling resulting from the droplet evaporation from causing freezing of the water vapour in the air. In addition, provision must be made for modification of the mixture in response to engine temperature and operation (warm-up, idle, cruise, full power or acceleration).

The modern carburetor is a fairly sophisticated device, with many small passages and jets, designed to meet all these needs under changing conditions. The carburetor can also be electronically controlled.

However, the fuel vaporization and mixing in a carburetted engine is far from perfect even under the best circumstances. Problems:

- a) Uneven fuel distribution between cylinders: fuel delivered to the various cylinders is not equal, some cylinders running a little rich and some a little lean. Typically, the mixture is adjusted so that the leanest cylinder is rich enough to run reliably, which means that the richest cylinder is probably putting considerable unburned hydrocarbons into the exhaust.
- b) Effects of non steady flow
- c) Balance of multi carburettor systems.
- d) Load change is transient: Under acceleration, the additional fuel sprayed from the accelerator jet is largely unevaporated.

8.2.2 INJECTION SYSTEM

A carburettor can be replaced by a fuel injection system. In fuel injection system the pressure of the fuel is monitored this improves control (pressure differences up to 5-7 MPa). A better control implies reduction of fuel consumption, reduction of pollution particularly unburned hydrocarbons and oxides of nitrogen. Main system are

DI: direct injection system the fuel is directly injected in the cylinder,

IDI: indirect injection system, the fuel is injected before the injection valve

MPI: multipoint injection system there is fuel injection into the intake port of each cylinder

SPI: Single Point Injection system, there are much simpler than the multipoint injection system but a single point injection does not solve either of the problems (a) or (d) of the carburettor.

8.2.3 MULTI POINT INJECTION (MPI)

Multi point injection (MPI) allows for electronic control and implies injection into the intake port of each cylinder.

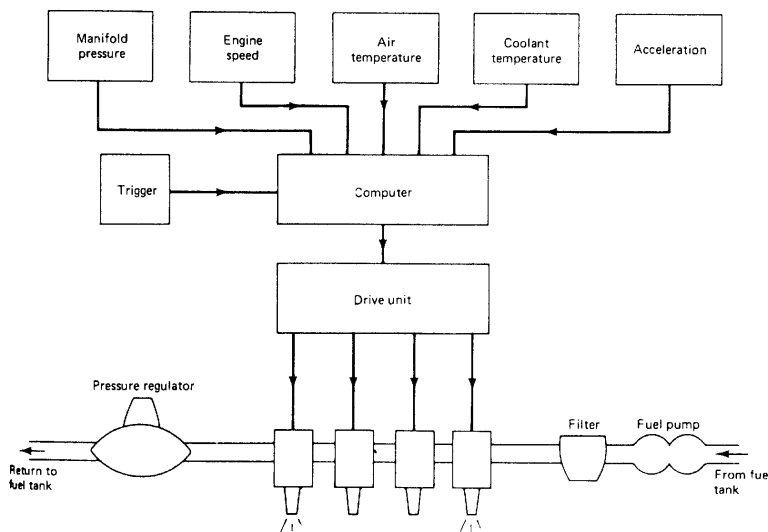

From Stone (1999)
figure 4.50 page 201.

Figure 8.2. Electronic fuel injection system

8.3 Performance

Each engine has a characteristic constant speed performance, with minimum sfc at a different ϕ for each throttle opening.

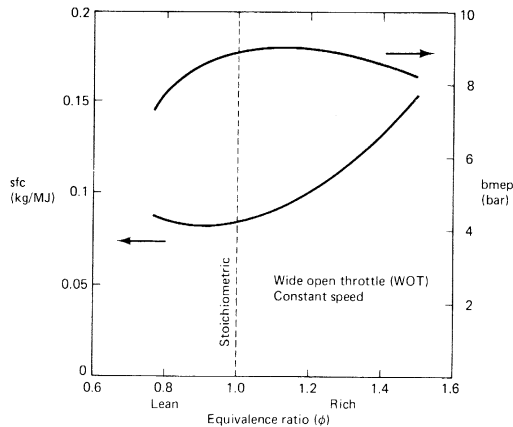

Figure 8.3. Spark engine performance

8.4 Combustion chamber design

The main considerations in combustion chamber design are:

- (i) the distance travelled by the flame front should be minimised. By minimising the distance between the spark plug and the end gas, combustion will be as rapid as possible. This has two effects:
 - Firstly, it produces high engine speeds and thus higher power output.
 - Secondly, the rapid combustion reduces the time in which the chain reactions that lead to knock can occur.

This implies that, for geometrically similar engines, those with the smallest diameter cylinders will be able to use the highest compression ratios.

- (ii) Good turbulence generation:
 - Sufficient turbulence to promote rapid combustion.
 - However, too much turbulence leads to excessive heat transfer from the chamber contents and also to too rapid combustion, which is noisy.

The turbulence can be generated by squish areas or shrouded inlet valves.

- (iii) The exhaust valve should be as close as possible to the sparking plug. The exhaust valve is very hot (possibly incandescent) so it should be as far from the end gas as possible to avoid inducing knock or pre-ignition.
- (iv) The end gas should be in a cool part of the combustion chamber. The small clearance between the cylinder head and piston in the squish area forms a cool region. Since the inlet valve is cooled during the induction stroke, this too can be positioned in the end gas region.

Combustion chamber design must optimise flame travel, generates good turbulence, that is use large valve area, small quench surface area. See some example in Stone (1999) figure 4.6, 4.10, 4.11, 4.13 Heywood (1988) figure 15.15 page 845.

8.5 Emissions

8.5.1 COMBUSTION KINETICS

A flame represents a fast reaction, only limited by chemical equilibrium at high temperature. But during expansion stroke there is a slow reduction of temperature during which the rate of reaction is itself reduced, and becomes much slower than the rate of change of equilibrium composition. Hence concentrations of dissociated products produced at high temperature (before expansion) become frozen at levels associated with these high temperatures. e.g.

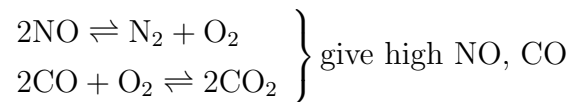

(From Heywood, 1988, page 594) figure 8.4 left Results or kinetic calculations of CO concentrations

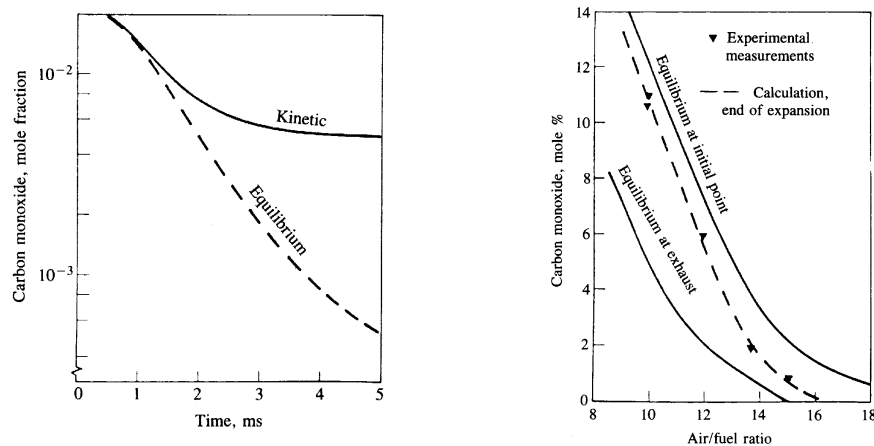

Figure 8.4. Formation of dissociate product

during expansion stroke following in SI engine stoichiometric mixture. figure 8.4 right Predicted CO concentration at end of expansion stroke, compared with measured exhaust concentrations, as function of air/fuel ratio α .

8.5.2 HYDROCARBONS (SEE HEYWOOD FIG. 11-1)

- Incomplete combustion of end gas
- compression of HC into crevices and absorption in oil layers and deposits
- expansion and desorption of HC at low pressure

(d) piston scrapes HC off walls and pushes into exhaust.

8.5.3 POLLUTION OF THE ENVIRONMENT

- a) NO, NO₂, CO are directly toxic
- b) NO contributes to acid rain
- c) NO_x with HC + sunlight → peroxyacetyl nitrates (brown fog e.g. Los Angeles or Athens)

8.5.4 EMISSIONS CONTROL

- a) Control of ϕ alone is insufficient since maximum NO_x occurs at $\phi \simeq 0.9$ (best s.f.c. !) (but see b-ii below)
- b) NO_x can be reduced if maximum temperature reduced. Options are
 - i mix exhaust gas with intake air (Exhaust Gas Recirculation, EGR)
 - ii Very lean mixture ($\phi < 0.65$), i.e. 'Lean Burn' - very difficult to control
- c) Catalyst in exhaust system,

oxidises CO, }
 oxidises HC } simultaneously
 reduces NO_x } (3 way catalyst)

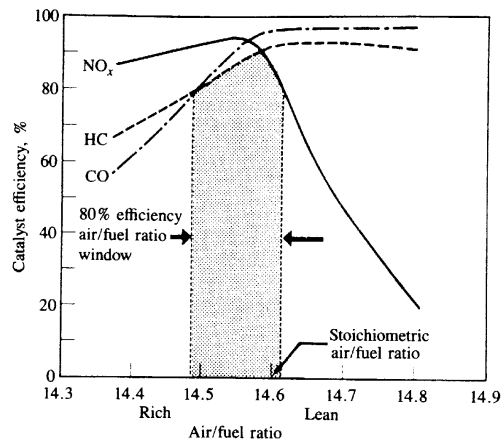

Figure 8.5. 3-way catalyst

As shown in figure 8.5, from Heywood (1988) page 656, this requires $\phi = 1.00$ for efficient operation. Hence usually combined with MPI and complex control system including λ sensor. (See also Stone, 1999, pages 172-3)

8.6 Stratified charge

Stratified charge means that mixture in the combustion chamber is not homogeneous any more. The combustion chamber contains a rich zone ($\phi \leq 1$) near the spark plug and a very lean zone

($0 < \phi < 0.6$) elsewhere.

- Open chamber (e.g. M.A.N. - FM, Texaco - Heywood Fig. 1.25)
- Torch Ignition (e.g. Honda CVCC - Stone Fig. 1.12)
- GDI gasoline direct injection (Mitsubishi, Toyota, ...)

But none yet commercially developed with improved overall performance/emissions.

8.7 Gas exchange processes

Objective: to replace the products of combustion in the cylinder with fresh air or fuel/air mixture (the 'charge').

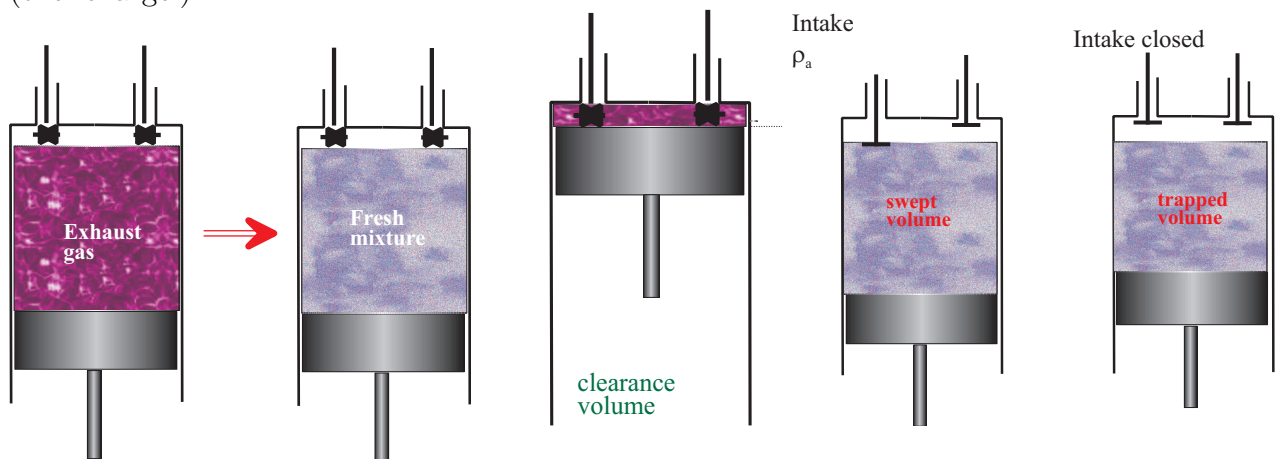

Figure 8.6. Gas exchange process

The process is complete when the charge is finally 'trapped'¹ in the cylinder at IVC (inlet valve closes) or EPC (condition 't').

The charge is usually mixed with some residual gas at partial pressure p_r

Trapped air mass m_a

$$m_a = \rho_a V_t = \frac{(p_t - p_r)V_t}{RT_t} \quad (8.1)$$

Nominal effectiveness is normally expressed in terms of the swept volume V_s by the volumetric efficiency:

$$\eta_{vol} = \frac{\text{actual } m_a}{\text{ideal } m_a} \text{ i.e. for a 4 stroke } = \frac{\dot{m}_a}{\rho_a V_s \frac{N}{120}}$$

¹Condition 't', we use subscript t in the formulas for trapped condition.

where ρ_a may be either of:

ρ_0 of atmospheric air (for overall charging effect)

ρ_i in intake manifold (if throttled, $\rho_i < \rho_0$ if supercharged, $\rho_i > \rho_0$)

8.7.1 SEQUENCE OF EVENTS IN FOUR STROKE CYCLE ENGINES

blow down $p_c \ll p_e$

exhaust expulsion

valve overlap:

a) throttled: $p_i < p_e$ hence exhaust backflow (internal EGR)

b) supercharged or tuned: $p_i > p_e$ hence charge through flow (scavenge) induction

backflow of charge into intake (if $p_c > p_i$ before IVC)

8.8 Admission Valve

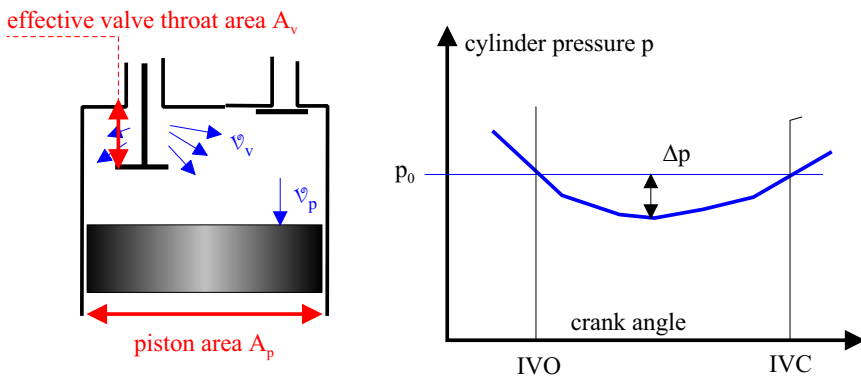

Figure 8.7. Admission valve

At minimum pressure in the cylinder

1) Assuming incompressibility continuity requires

$$A_v \mathcal{V}_v = A_p \mathcal{V}_p$$

2) From Bernoulli equation we have

$$\Delta p = \frac{1}{2} \rho \mathcal{V}_v^2$$

3) If the geometrical area at the valve is A_g and A_v is the effective valve throat area, $A_v < A_g$ we define a discharge coefficient C_D such that

$$A_v = C_D A_g$$

Typically, $C_D \simeq 0.6, 0.7$ but depends on the definition of A_g

8.8.1 EXERCISE

In a 4-stroke engine cylinder with the inlet valve(s) fully open, typical maximum ratios of geometric valve flow area to piston area are:

- (a) 0.2 (single inlet valve)
- (b) 0.26 (two inlet valves)

For a given engine with a stroke of 100 mm, the maximum piston speed is 1.62 times the mean piston speed and a coefficient of discharge of 0.65 may be used for flow through the valves. If the maximum instantaneous pressure drop across the inlet valves during the induction stroke is 0.2 bar, estimate the corresponding engine speed for each design. (Neglect compressibility effects for this estimate and assume intake gas is air at 1 bar, 300 K)

Answers: (a) 4440, (b) 5770 rev.min⁻¹

Appendix of chapter 8

8.A Diagram of an L-Jetronic system

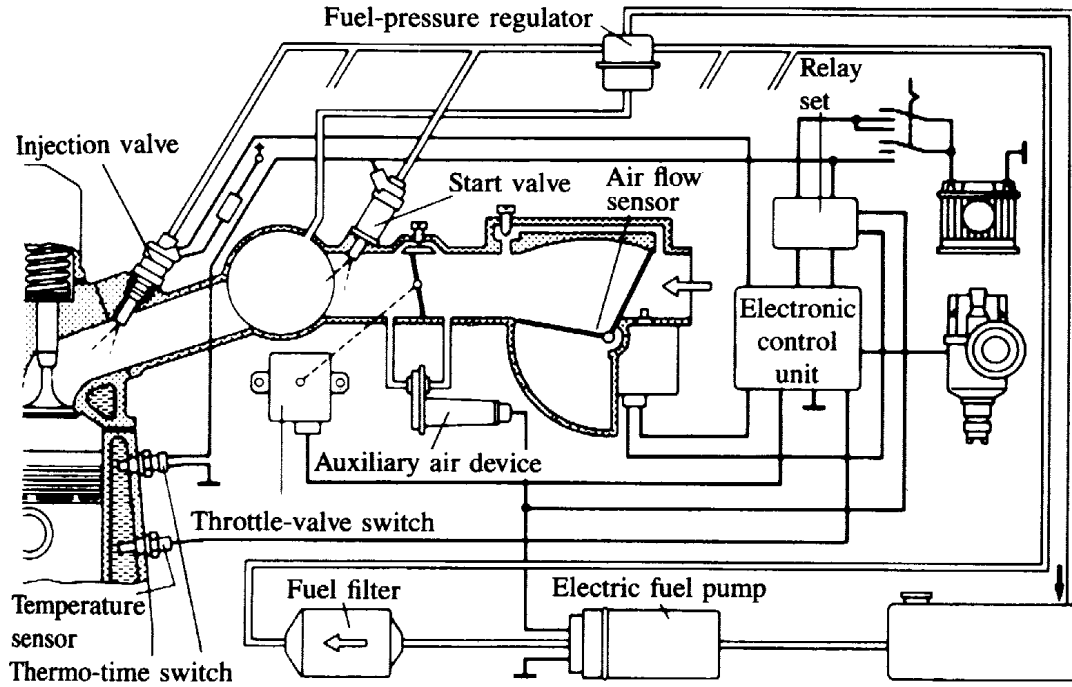

Figure 8.8. Electronic multipoint port fuel injection system L-Jetronic system

From Heywood (1988) figure 7-12 page 297.

8.B European Vehicle Exhaust Emission Standards

Maximum pass levels from analysis of constant volume bag sample for duration of EU test drive cycle passenger cars only Ail values n g.km⁻¹

Spark ignition engines **diesel engines** (where different)

Year	CO	HC	NO _x				
1971		14					
1977		12	3.0				
1979		10.5	2.5				
		HC + NO _x					
1984	10	5					
1988		2					
1993	2.72	0.97					
1997	2	0.5		1997	1	DI 0.9 - IDI 0.7	
2000*	2.3	0.2	0.15	2000*	2.3	0.12	0.15
2005*	1	0.1	0.08	2005*	1	0.1	0.08

* including cold start

Chapter 9: Combustion ignition engines: diesel engines

9.1 Combustion

9.1.1 FUNDAMENTAL FEATURES

In diesel engines, the spark plug is replaced by a fuel injector and only air is compressed during the compression process.

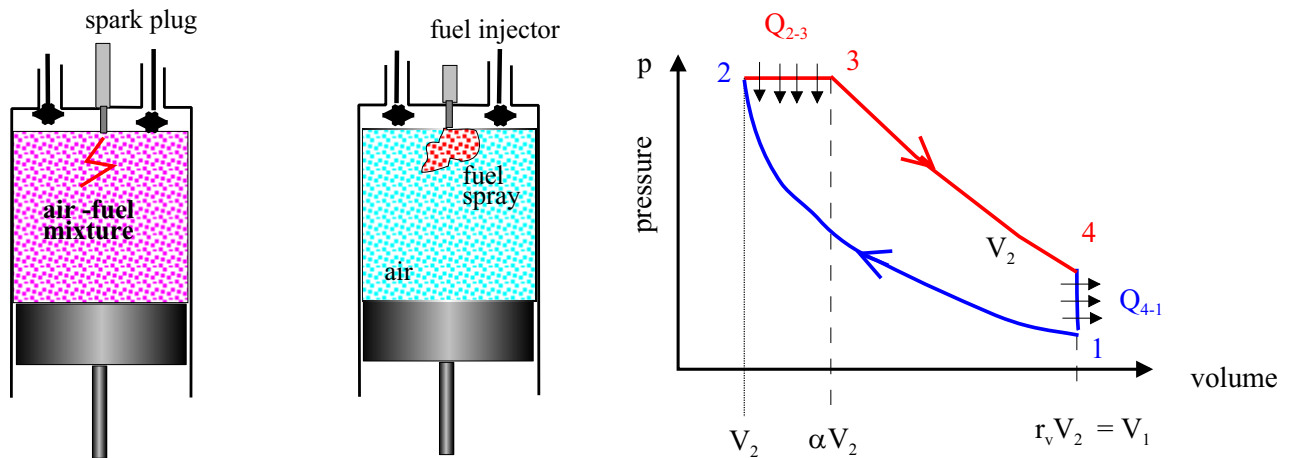

Figure 9.1. Diesel cycle

In an ideal diesel cycle the processes are all reversible, and are as follows

1-2 isentropic compression of air through a volume ratio or

compression ratio

$$r_v = \frac{V_1}{V_2}$$

2-3 addition of heat Q_{2-3} at constant pressure while the volume expands through

α **the load or cut-off ratio**

$$\alpha = \frac{V_3}{V_2}$$

3-4 isentropic expansion of air to the original volume V_1

4-1 rejection of heat Q_{4-1} at constant volume to complete the cycle

- Fuel is injected at the end of compression after point 2
- ignition results from a high air temperature

9.1.2 REQUIREMENTS

- High compression ratio
- Easily ignited fuel (high Cetane number - see 8.3)
- Engine design to optimise rapid mixing of fuel and air

9.1.3 COMBUSTION SEQUENCE

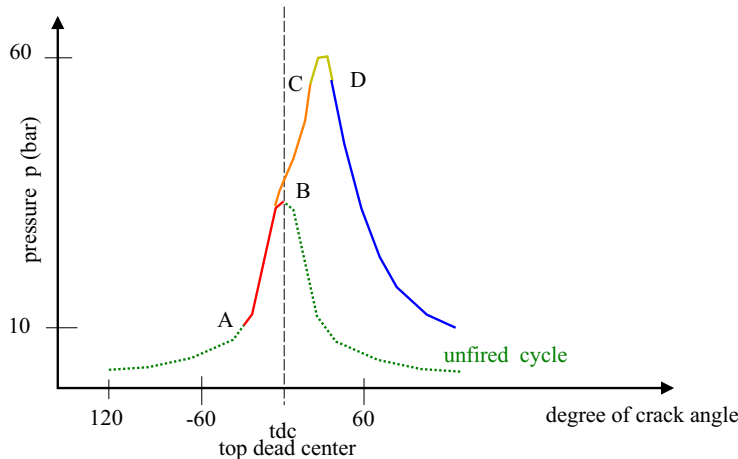

Figure 9.2. Diesel sequence

- Stage 1: A-B ('ignition Delay'): Preliminary mixing, evaporation and low temperature chain reactions, ending with visible multiple ignition sites.
- Stage 2: B-C rapid combustion. Premixed flames engulf 'prepared' regions of mixture. Sudden pressure rise ('diesel knock').
- Stage 3: C-D controlled combustion. The remainder of the fuel burnt by diffusion flames (Radiant flame with formation and combustion of soot).

9.2 Design aspects

9.2.1 FUEL AND AIR REQUIREMENTS

- Very high fuel injection pressures (e.g. 200 to 2000 bar) in order to deliver required quantity of atomised droplets into high pressure air in the shortest possible time.
- Air motion to match fuel trajectory and optimise mixing.
 - Swirl implies rotation of all the air about the cylinder or prechamber axis, normally generated during the induction stroke.

- Squish implies a squeezing effect between piston edge and cylinder head, resulting in a lateral or radial airflow, and often a powerful toroidal vortex in which the swirl is amplified by a reduction of radius with the same moment of momentum.
- Combustion chambers for smaller Direct Injection (D.I.) high speed engines may be designed for wall wetting by the fuel, because impingement of the fuel jet on some part of the cylinder wall cannot be prevented. This is commonly combined with both swirl and squish (Heywood, 1988, figure 10-1, page 494).
- Other small engines use Indirect Injection (I.D.I.) of the fuel into some form of prechamber (Heywood, 1988, figure 10-2, page 495) which generally reduces noise but increases heat loss and fuel consumption.

9.2.2 GENERAL

- Speed: Stage 1 of combustion is difficult to accelerate because chemical kinetics are not affected by turbulence; the effect of high engine speed is therefore to create a large region of evaporated fuel before ignition, and intensified 'Diesel knock'. This places a limit on the maximum engine speed.
- Cylinder size: not limited by combustion (good for ship)
- Maximum load: usually limited by exhaust smoke (soot) (at least for naturally aspirated engines) to a lower bmep than for spark ignition (i.e. overall $\phi < 1$). Turbocharging can however more than double the output without combustion limitations, giving high power/weight and power/cost.
- Structure: High cylinder pressures and vibration sometimes require a heavier engine than for SI.
- Cost: High pressure fuel injection requires very high precision components, which are the major cost premium in small naturally aspirated engines.

9.2.3 FUEL INJECTION SYSTEMS

(e.g reference Stone, 1999, §5.5.2 page 234)

- Requirements:
 - High pressure pump
 - Precision injector: nozzles to match combustion system exact on/off control

- Control of injection timing and of volume injected.
- Hardware:
 - Plunger pumps (1 per cylinder) (with separate HP fuel pipes or Rotary distributor pump) and injectors or Unit injectors operated directly from camshaft
 - Governor or electronic control unit
- Normal Features:
 - Spill port controls start and end of injection
 - Spill timing by helical grooves in pump piston or solenoid control of spill port
 - Pump delivery valve and injector pressure balance provide bi-stable injector switching

9.3 Fuel and cetane number

'Diesel' or 'Derv' is typically gasoil, i.e. a crude oil fraction of higher density and lower volatility than gasoline.

The Cetane Number measures its quality in reducing diesel knock, i.e. in producing rapid ignition (effectively the opposite requirement to that for a high octane fuel, and hence a long straight chain compound is good).

Definition:

The cetane number of a fuel is the % n-cetane ($C_{16}H_{34}$) in a mixture of n-cetane with α -methyl naphthalene ($C_{11}H_{10}$ double ring) which gives the same diesel knock effect as the fuel under test.

In practice, α -methyl naphthalene is found to be insufficiently stable for standard tests, and heptamethyl nonane (HMN, $C_{16}H_{34}$, CN=15) is used in ASTM method D613 such that $CN = \% \text{ n-cetane} + 0.15 \times \% \text{ HMN}$.

9.4 Emissions

9.4.1 INCOMPLETE COMBUSTION PRODUCTS

- Soot (from diffusion flames) very sensitive to
 - combustion design,
 - injector maintenance

- HC, oxygenates, CO from decomposed fuel in fuel rich regions quenched lean flames.

For future standards, these components may need an oxidation reactor. (Also is some soot carcinogenic? Can micron sized particles harm the lungs?)

9.4.2 NO_x PRODUCTION

NO_x is formed locally wherever $0.7 > \phi > 0.9$ at high temperatures. It is generally regarded as the most serious constituent since:

- 3 way catalyst is not applicable
- it is hard to reduce NO_x in an oxidising atmosphere.

EGR and water injection can be used to reduce the temperature and hence formation rate. Retarded injection timing also reduces maximum temperature

9.5 Spark ignition engines compared to compression ignition engines

9.5.1 EMISSIONS

Generally less fundamentally serious for compression ignition than emissions from spark ignition engines due to

- overall lean mixture
- low sensitivity to engine temperature on start up

9.5.2 NATURALLY ASPIRATED ENGINES: EFFECT OF OVERALL FUEL/AIR RATIO

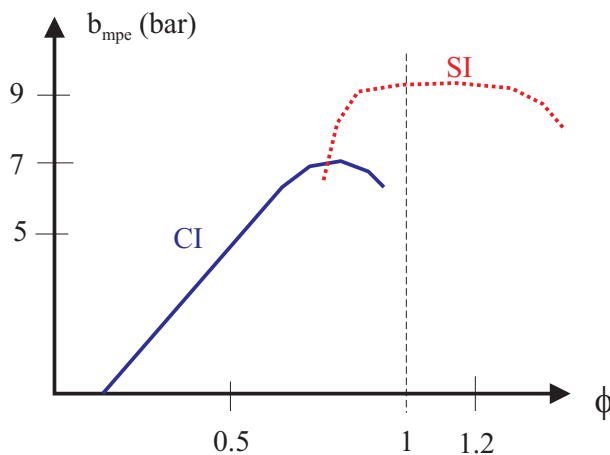

Figure 9.3. CI and SI ϕ régimes

9.5.3 TYPICAL PARAMETERS

	spark ignition	compression ignition
Max. cylinder bore, mm	150	1000
Compression Ratio	8-12	12 - 24
Max. bmep, bar	10	8 (N.A.) 10-20 (T/C)
Max. cylinder pressure, bar	50	100
Max. Rev/min	5000- 15000	5000
Load control	Throttle	Fuel volume only
Emissions	CO,NO _x ,HC	NO _x , HC, particulates

9.5.4 FUEL CONSUMPTION

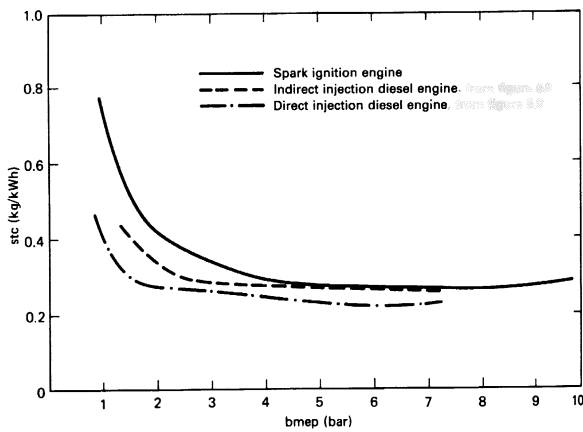

Figure 9.4. Comparison of the part load efficiency of engines at 2000 rpm (Stone, R.) spark ignition and Diesel

Chapter 10: Two stroke cycle engines

(p 320 Stone, 1999, ch 7)

10.1 Sequence of events

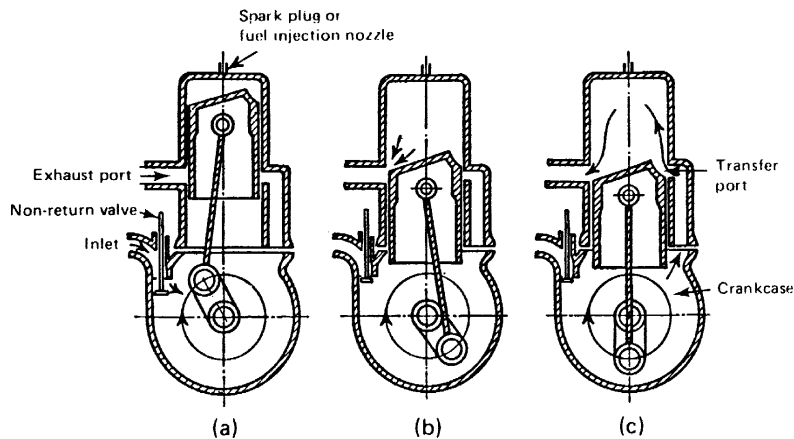

Figure 10.1. Two stroke piston engine - scavenging

With reference to figure 10.1 the following processes occur in a two-stroke engine, at times determined by the piston covering and uncovering ports in the cylinder wall:

- 1) At about 60° before bottom dead centre the piston uncovers the exhaust port and exhaust blowdown occurs, such that the cylinder pressure approaches the ambient pressure. This is the end of the power stroke.
- 2) Some $5\text{-}10^\circ$ later the inlet port is opened and the charge compressed by the underside of the piston in the crankcase is able to flow into the cylinder. With this loop scavenge arrangement (figure c), the incoming charge displaces and mixes with the exhaust gas residuals; some incoming charge will flow directly into the exhaust system.
- 3) The scavenge process ends with both the crankcase and cylinder pressure close to the ambient pressure level once the inlet port is closed (about 55° after bottom dead centre). Towards the end of the scavenge process, there can be a backflow of charge and exhaust gas residuals into the crankcase. The upward movement of the piston now reduces the pressure in the crankcase.
- 4) At about 60° after bottom dead centre the exhaust port is closed, and the charge is compressed by the upward motion of the piston.

- 5) At about 60° before top dead centre the pressure in the crankcase is significantly below the ambient pressure, and the crankcase port opens to allow the incoming charge to flow into the crankcase.
- 6) Ignition occurs typically within the range of $10-40^\circ$ before top dead centre. Work is done by the engine on the gas until top dead centre, at which point the power stroke starts, and continues until the exhaust port opens.
- 7) The crankcase port is closed at about 60° after top dead centre, but prior to this there will be some outflow of gas from the crankcase, as the crankcase pressure will have risen above the ambient pressure level around top dead centre.

Two undesirable features of the two-stroke engine are

- the mixing of the incoming charge with the exhaust residuals,
- and the passage of the charge directly into the exhaust system.

The fuel loss due to these shortcomings is largely eliminated in diesel engines (not considered here are model diesel engines), as they are invariably supercharged and there is in-cylinder fuel injection.

10.2 Design Options

Sequence of events:

blow down $p_{charge} \gg p_{exhaust}$ (and $p_{charge} \gg p_{scavenge}$)

scavenge $p_{scavenge} > p_{exhaust}$ requires scavenge pump / blower

Scavenge system: Uniflow, Loop or cross flow Ports and/or valves Crankcase, under piston, or separate pump

Exhaust tuning

Supercharge (requires increased exhaust pressure)

10.3 Scavenge process

As some air has leaked through the exhaust $m_a \neq m_s$.

10.3.1 DIMENSIONLESS PERFORMANCE PARAMETERS

In order to discuss the gas exchange performance of two-stroke engines, it is necessary to define several gas flow parameters.

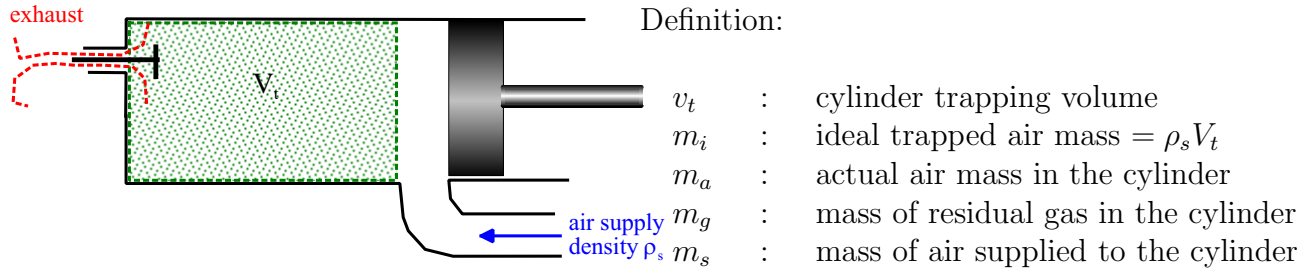

Figure 10.2. Scavenge process in a two stroke engine

Scavenge ratio or delivery ratio λ

$$\lambda = \frac{m_s}{m_i} \tag{10.1}$$

Scavenge efficiency η_{sc}

$$\eta_{sc} = \frac{m_a}{m_a + m_g} \tag{10.2}$$

Charging efficiency η_{ch}

$$\eta_{ch} = \frac{m_a}{m_i} \tag{10.3}$$

Trapping efficiency η_{tr}

$$\eta_{tr} = \frac{m_a}{m_s} = \frac{\eta_{ch}}{\lambda} \tag{10.4}$$

There is a special case if we assume p and T to be constant throughout:

$$m_a + m_g = m_i$$

and

$$\eta_{sc} = \eta_{ch}$$

but in practice, $T_g > T_s$, $\rho_g < \rho_s$, $m_a + m_g < m_i$ and $\eta_{sc} > \eta_{ch}$

10.3.2 PERFECT DISPLACEMENT MODEL

In this model exhaust products are displaced by fresh mixture without mixing

for $0 < \lambda < 1$:
 $m_a = m_s, \eta_{tr} = 1, \eta_{ch} = \lambda$

for $\lambda > 1$:
 $m_a = m_i, \eta_{ch} = 1, \eta_{tr} = 1/\lambda$

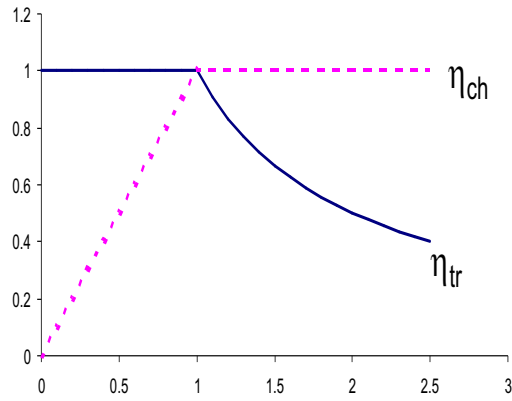

Figure 10.3. Perfect displacement scavenging

10.3.3 COMPLETE MIXING

We assume

- i) Fresh supply mixes with contents completely and instantly.
- ii) The effective cylinder is V_t throughout.

Now ii) requires

$$dV_t = 0 = \frac{dm_s}{\rho_s} - \frac{dm_{ex}}{\rho}$$

that is

$$\frac{dm_e}{dm_s} = \frac{\rho}{\rho_s} = \frac{m_a + m_g}{m_i} = \frac{\eta_{ch}}{\eta_{sc}}$$

The increment of the trapped charged is

$$dm_a = dm_s - \eta_{sc} dm_e = dm_s - \eta_{ch} dm_s = dm_s(1 - \eta_{ch})$$

But m_i is fixed, and $dm_a = m_i d\eta_{ch}$, $dm_s = m_i d\lambda$ so that

$$d\eta_{ch} = d\lambda(1 - \eta_{ch})$$

and

$$\lambda = K + \int \frac{d\eta_{ch}}{1 - \eta_{ch}} = K + \ln(1 - \eta_{ch})$$

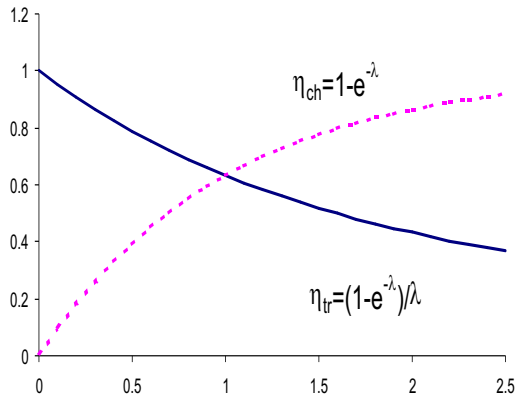

Figure 10.4. Complete mixing scavenging, as a function of λ

10.3.4 SHORT CIRCUIT FLOW

Each increment of fresh charge supplied is immediately discharged to exhaust. Hence for all dm_s and all λ :

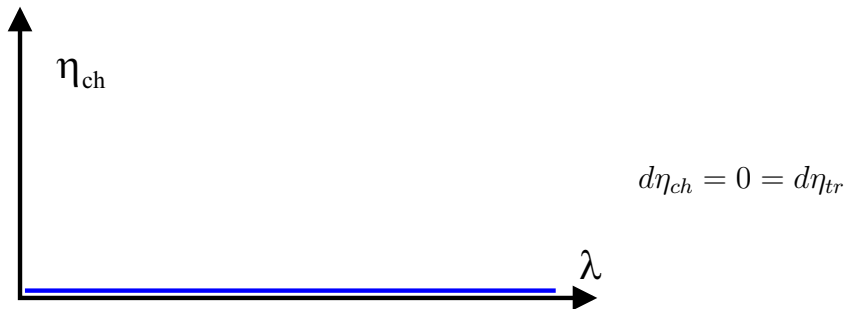

Figure 10.5. Short circuit scavenging

10.3.5 COMBINED SCAVENGE MODEL

Models 10.3.2, 10.3.3 and 10.3.4 may be combined in any desired manner e.g. suppose initial scavenge a is by displacement, followed by a combination b of displacement, mixing and short circuit as in figure 10.6.

Then total

$$d\eta_{ch} = \delta d\lambda + \mu(1 - \eta_{ch})\delta d\lambda$$

hence

$$d\lambda = \frac{d\eta_{ch}}{\delta + \mu(1 - \eta_{ch})}$$

and

$$\lambda - \lambda_I = \int_{\lambda_I}^{\eta_{ch}} \frac{d\eta_{ch}}{\delta + \mu(1 - \eta_{ch})} = -\frac{1}{\mu} \ln \left[\frac{\delta + \mu(1 - \eta_{ch})}{\delta + \mu(1 - \lambda_I)} \right]$$

- a: from 0 to 1, $\eta_{ch} = \lambda_I$
 Boundary condition at I is $\eta_{ch} = \lambda_I$
- b: from I to II assume:
- fraction δ of supply displaces:
 $d\eta_{ch} = \delta d\lambda$
 - fraction μ of supply is mixed:
 $d\eta_{ch} = \mu(1 - \eta_{ch})\delta d\lambda$
 - fraction $(1 - \delta - \mu)$ is short circuited:
 $d\eta_{ch} = 0$

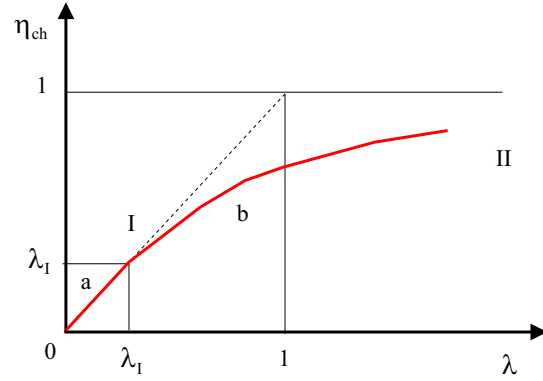

Figure 10.6. Combined scavenge model

10.3.6 EXERCISE

The scavenging of a certain 2-stroke cylinder may be described as follows:

Displacement scavenge up to 30% Scavenge Ratio after which 90% of all further fresh charge undergoes mixing scavenge, and the remainder is lost by direct short circuit.

By assuming uniform gas pressure and temperature, show that for Scavenge Ratio $\lambda > 0.3$, the charging efficiency η_{ch} is given by

$$\eta_{ch} = 1 - 0.917 \exp(-0.92\lambda)$$

and evaluate η_{ch} for unit scavenge ratio. Compare this result with that which would be obtained by assuming mixing scavenge throughout.

Answers: 0.627, 0.632

10.4 Power losses from scavenge flows

A high scavenge flow would be needed to achieve (e.g.) $\eta_{ch} = 0.8$ and the pumping requirement needs to be assessed.

- a) The port pressure loss ($\Delta p = p_s - p_e$) depends on the aerodynamics of the port design. This may be expressed as

$$\Delta p = C_L \left(\frac{1}{2} \rho \mathcal{V}^2 \right)$$

where C_L is the overall loss coefficient due to the ports and ducting and $\mathcal{V} \sim N\lambda$ is the gas velocity through the port for a given engine at N rev.min⁻¹. Hence

$$\Delta p \sim \rho(N\lambda)^2$$

b) Power consumption: from SFEE

$$-\dot{W}_{rev} = \int_s^e \dot{V} dp \simeq \dot{V} \Delta p$$

if Δp is small and hence since

$$\dot{V} \sim N\lambda$$

also

$$-\dot{W}_{rev} \simeq \rho(N\lambda)^3 \quad (10.5)$$

or for a real scavenge pump with isentropic efficiency η_c :

$$\dot{W}_{sc} \sim \frac{\rho(N\lambda)^3}{\eta_c}$$

10.4.1 EXERCISE

For the engine of exercise 10.3.6, the total pressure drop Δp across the cylinder ports is found to be 0.25 bar when $\lambda = 1.0$. The fresh charge is supplied by a mechanically driven compressor of isentropic efficiency 0.85.

- (a) What is the compressor work loss when expressed as a loss of mean effective pressure of the engine? (Assume that cylinder trapping volume = swept volume).
- (b) The engine power is to be raised by increasing the scavenge flow until $\eta_{ch} = 0.8$. Find the required value of λ and estimate the new work loss involved.

Assume compressibility may be neglected, so that $\Delta p \sim \lambda^2$ and density changes are ignored. Is this assumption justified by your result?

Answers: (a) 0.29 bar, (b) 1.69, 1.4 bar

10.5 Comparison with four stroke engines

The absence of the separate induction and exhaust in the two-stroke engine is the fundamental difference from four-stroke engines. In two-stroke engines, the gas exchange or scavenging processes can be the induction and exhaust occurring simultaneously. Consequently the gas exchange processes in a two-stroke engine are much more complex than in four-stroke engines, and the gas exchange is probably the most important factor controlling the efficiency and performance of two-stroke engines.

Two-stroke engines can be either spark ignition or compression ignition, and currently the largest and smallest internal combustion engines utilise two-stroke operation. The smallest engines are those used in models, for which compression ignition (perhaps assisted by a glow plug for starting)

is more common than spark ignition. The output of these engines is frequently much less than 100 W. Small two-stroke engines with outputs in the range of approximately 1-100 kW are usually naturally aspirated with spark ignition. The typical applications are where low mass, small bulk and high-power output are the prime considerations - for example motor cycles, outboard motors, chain saws, small generators etc.

	4 stroke	2 stroke
Fuelling	port injection	cylinder injection
Evaporation	heated port wall	air blast spray
Overall ϕ	$\phi = 1.$	$\phi < 1$ (air through flow) lean
Max bmep (p_{bm})	10 bar	6 bar ?
NO _x control	3 way cat. + EGR	internal EGR
HC control	3 way cat.	oxidation cat.

Revision questionnaire of Part II

- 1) What are swept volume and volumetric efficiency in a piston engine?
- 2) What are mean effective pressure, brake mean effective pressure and indicated mean effective pressure, friction mean effective pressure?
- 3) When are two-stroke engines to be used?
- 4) Explain the difference between spark ignition engine and compression ignition engine.
- 5) What are direct and indirect injection in the context of piston engines?
- 6) Explain the difference between carburettor single point injection and multipoint injection.
- 7) What is the interest of stratified charges?
- 8) Give the main criteria for combustion chamber design.
- 9) Plot Otto and diesel p - V diagrams.
- 10) What is knock in spark engine and how can it be prevented?
- 11) What are the 1st stage and 2nd stage of combustion in a spark engine and how are they defined?
- 12) What is the difference between swept and trapped volume?

Part III

Supercharging and Turbocharging

Chapter 11: Supercharging and turbocharging

Breathing exercises (Stone, 1999, ch 9), (Lumley, 1999, 2.14)

11.1 Purpose

Engine power can be increased if more air can be trapped in the cylinder by raising the pressure and hence the density ρ_a of the air.

An engine is supercharged or turbocharged if the mean pressure at the intake port is higher than ambient.

11.1.1 SUPERCHARGER

Supercharging used to be the generic term for using some mechanical device for increasing the inlet density; now

Supercharger refers to mechanically driven compressor; it is take to refer only to positive displacement devices.

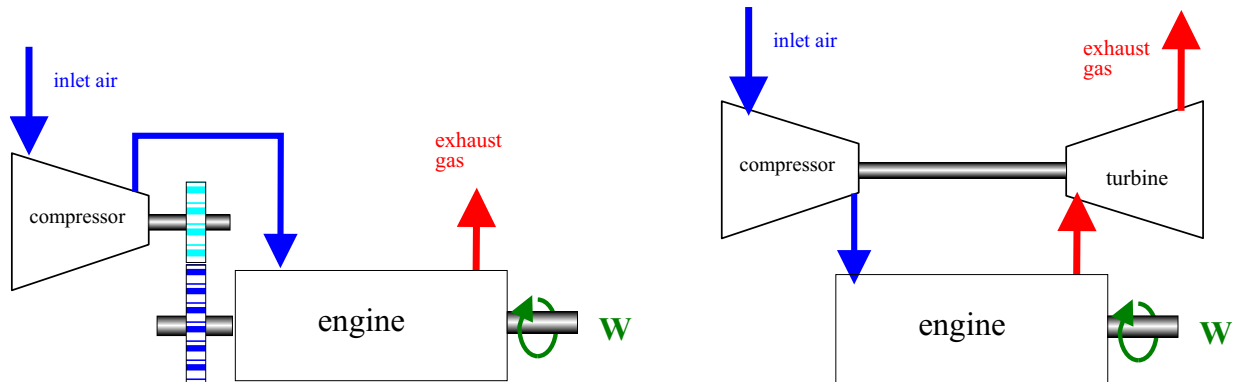

Figure 11.1. Supercharging (left) and turbocharging (right)

In a positive displacement device there is no direct connection between inlet and outlet; air is taken into a chamber, which is then closed. The volume of the chamber may be reduced, increasing the pressure, and the chamber is then opened to the outlet that is the engine inlet as in figure 11.1 left.

Roots shown in figure 11.2 are positive displacement machines. The rotors in the roots are not in contact, but are held in the proper relative position, and are rotated, by gears outside the compressor casing. Notice that the air trapped between the rotors in the Roots is not compressed

(since the volume of the space does not change), until it is delivered to the receiver at the outlet, when it is compressed by the backflow of the higher pressure air in the receiver. For this reason, the efficiency of the Roots is a little lower than that of other types. The vanes in the Judson, on the other hand, slide in and out, changing the volume of the spaces as they carry the air around from inlet to outlet.

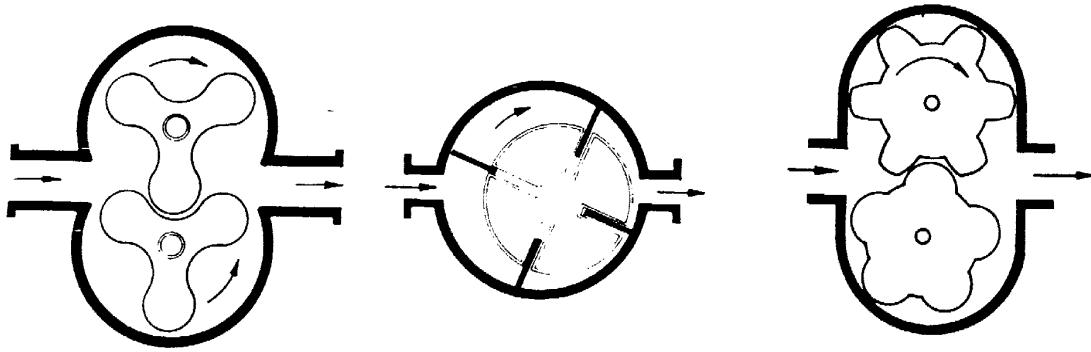

Figure 11.2. Examples of superchargers, Roots blower, vane compressor, screw compressor

11.1.2 TURBOCHARGERS

In a turbocharger the exhaust turbine is driven by the compressor see figure 11.3.

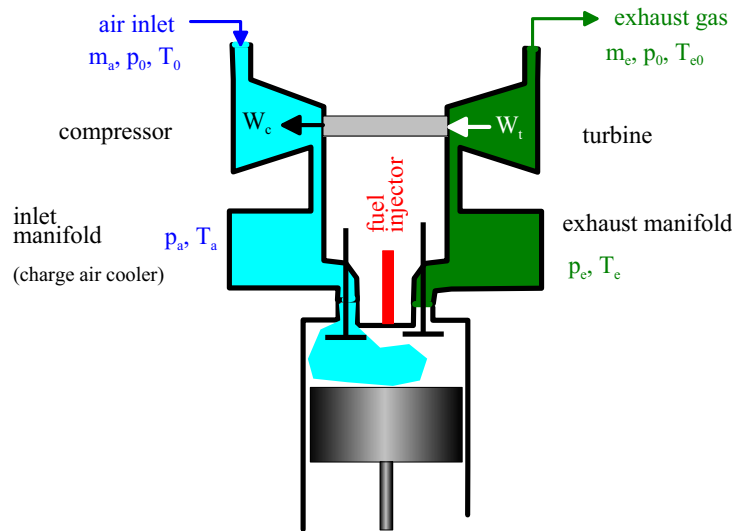

Figure 11.3. Schematic of turbocharged engine system

Turbocharging is used to refer to dynamic device. A dynamic device is one, like a centrifugal compressor, in which there is a direct connection between the inlet and the outlet (so that, if the device were not rotating, there would be no pressure difference), and which produces its pressure difference from the motion of winglets, or blades, through the air, produced by rotation of the device.

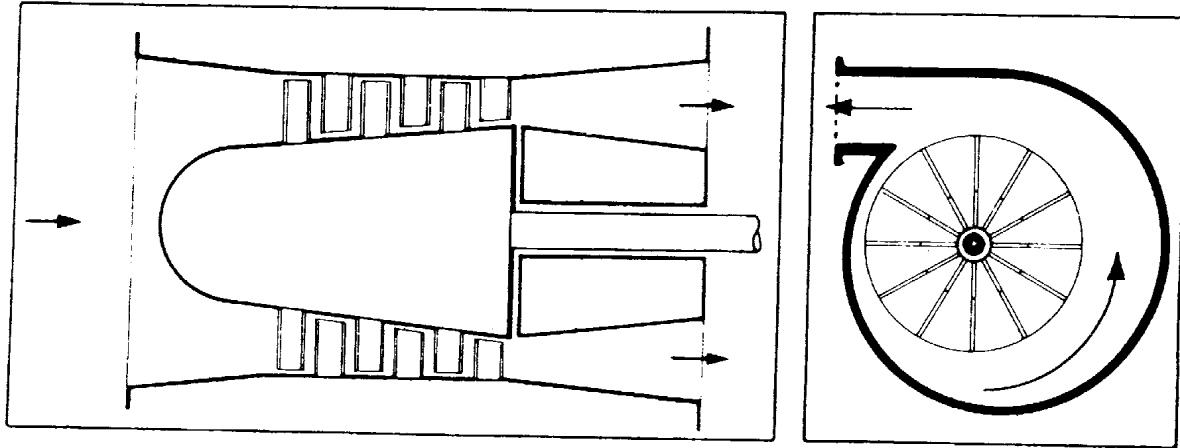

Figure 11.4. Example of turbochargers, left axial compressor right radial compressor

In the simplest design the air goes through the compressor then reacts with the fuel in the engine and the products of the reaction enter the turbine. At any time the work delivered by the turbine is equal to the work received by the compressor (except for friction losses). Turbine and compressor shaft velocity are the same. Mechanical energy is available from the exhaust gas because the cylinder pressure at EVO is higher than ambient (e.g. 4 bar). There is also thermal energy due to its high temperature, but an exhaust turbine converts very little of this. The transmission of this mechanical 'pulse energy' to a turbine may however be complex. According to the relative connection of the engine and the turbine there are two turbocharging systems

- constant pressure turbocharging § 11.3 and
- pulse system § 11.4

11.1.3 OTHER DEVICES

There exist more complex systems such as

- Pressure wave exchanger ('compresx')
- Compound engine (other arrangements of engine, turbine and compressor)

11.2 Thermodynamic analysis of turbochargers

The operation of a compressor or turbine can be shown on a temperature/ entropy $T-s$ plot (figure 11.5). The ideal compressor is both adiabatic and reversible and is thus isentropic. Real processes are of course irreversible, and are associated with an increase in entropy; Expressions for specific work can be derived from the steady-flow energy equation (SFEE):

for an adiabatic turbine ($w_t > 0$)

$$w_t = h_{in} - h_{out} = h_3 - h_4 \tag{11.1}$$

and for an adiabatic compressor ($w_c < 0$)

$$w_c = h_{in} - h_{out} = h_1 - h_2 \tag{11.2}$$

For real gases, enthalpy is a strong function of temperature and a weak function of pressure. For

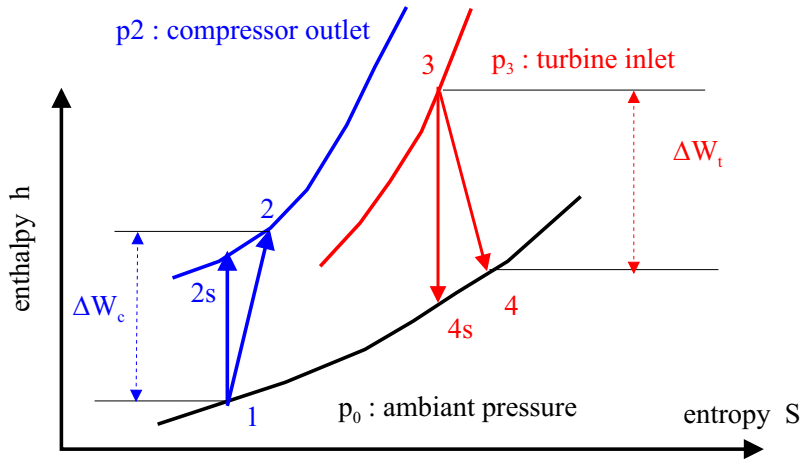

Figure 11.5. Enthalpy as a function of entropy diagram for a turbocharger

semi-perfect gases, enthalpy is solely a function of temperature, and this is sufficiently accurate for most purposes. Thus

$$w_c = c_p(T_2 - T_1)$$

and

$$w_t = c_p(T_3 - T_4)$$

where c_p is an appropriate mean value of the specific heat capacity. Consequently the T - s plot gives a direct indication of the relative compressor and turbine works. This leads to isentropic efficiencies that compare the actual work with the ideal work:

compressor isentropic efficiency:

$$\eta_c = \frac{h_{2s} - h_1}{h_2 - h_1} = \frac{T_{2s} - T_1}{T_2 - T_1} \tag{11.3}$$

and turbine isentropic efficiency,

$$\eta_t = \frac{h_3 - h_4}{h_3 - h_{4s}} = \frac{T_3 - T_4}{T_3 - T_{4s}} \tag{11.4}$$

It may appear unrealistic to treat an uninsulated turbine that is incandescent as being adiabatic. However, the heat transferred will still be small compared to the energy flow through the turbine.

In a turbocharger the compressor is driven solely by the turbine, and a mechanical efficiency can be defined as

$$\eta_m = \frac{m_{12}c_{p12}(T_2 - T_1)}{m_{34}c_{p34}(T_3 - T_4)}$$

The pressure ratios across the compressor and turbine are very important. From the pressure ratio the isentropic temperature ratio can be found:

$$\frac{T_{2s}}{T_1} = \left(\frac{p_2}{p_1}\right)^{\frac{\gamma-1}{\gamma}} \quad (11.5)$$

and

$$\frac{T_3}{T_{4s}} = \left(\frac{p_3}{p_4}\right)^{\frac{\gamma-1}{\gamma}} \quad (11.6)$$

The actual temperatures, T_2 and T_4 , can then be found from the respective isentropic efficiencies.

11.3 Constant pressure turbocharging

In constant pressure systems a plenum chamber is placed in between the engine and the turbine. In this exhaust manifold the kinetic energy of the gas is converted into pressure

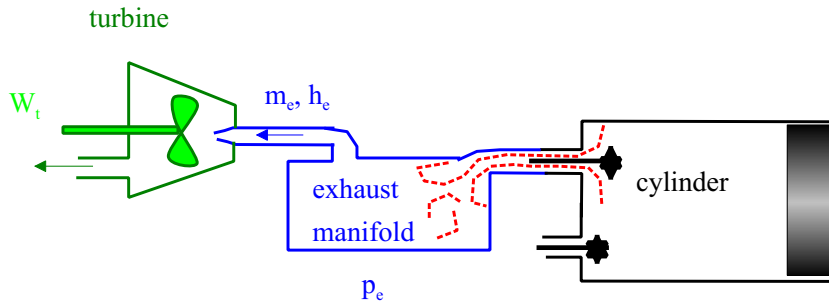

Figure 11.6. Typical arrangement of a constant pressure system

In constant-pressure turbocharging it is desirable for the inlet pressure to be greater than the exhaust pressure ($p_2/p_3 > 1$), in order to produce good scavenging. This imposes limitations on the overall turbocharger efficiency (η_m, η_t, η_c) for different engine exhaust temperatures (T_3).

11.4 Pulse system

The flow from an engine is unsteady, owing to the pulses associated with the exhaust from each cylinder, yet turbines are most efficient with a steady flow. If the exhaust flow is smoothed by using a plenum chamber, then some of the energy associated with the pulses is lost.

The usual practice is to design a turbine for pulsed flow and to accept the lower turbine efficiency. The turbine is set just at the exit of the cylinder with a minimum length exhaust pipe of volume

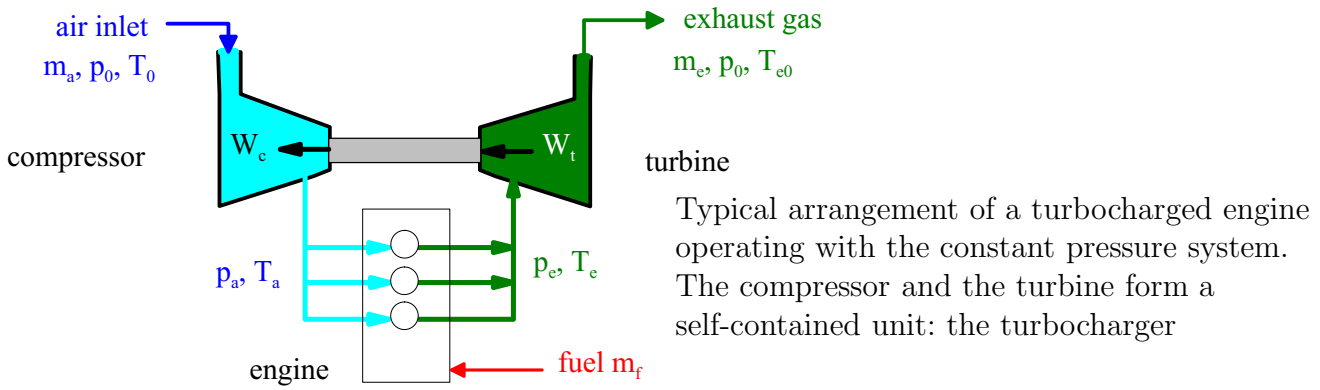

Figure 11.7. Constant pressure system for several cylinders

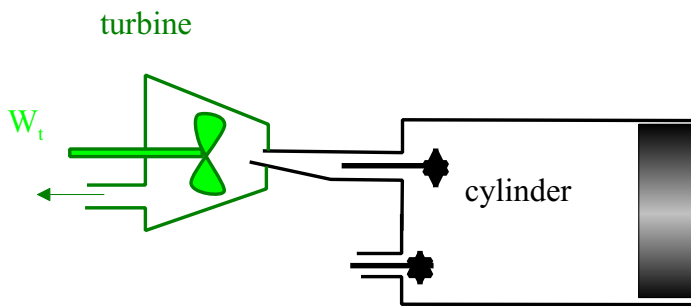

Figure 11.8. Typical arrangement for pulse system

V_0 . The Exhaust valve opens suddenly and pressure rise instantaneously at the turbine inlet, the burnt gases expand in the turbine providing some work W_t , this is the pulse. The higher V_0/V_s the higher the pressure rise at the turbine inlet and the higher W_t

However, if the compressor pressure ratio is above 3:1 the pressure drop across the turbine becomes excessive for a single stage. For four-stroke engines no more than three cylinders should feed the same turbine inlet. Otherwise there will be interactions between cylinders exhausting at the same time.

For a four-cylinder or six-cylinder engine a turbine with two inlets should be used. The exhaust connections should be such as to evenly space the exhaust pulses. Figure 11.10 shows a typical arrangement of a turbocharged engine operating with the pulse system for a four cylinder engine.

A more realistic approach is to use pulse converters to connect groups of cylinders that would otherwise be separate. For example, four cylinders could be connected to a single turbocharger entry, (figure 9.14 Stone, 1999). The steadier flow can also lead to an improvement in turbine performance. The design of the pulse converter is a compromise between pressure loss and unwanted pulse propagation. Reducing the throat area increases the pressure loss, but reduces the pulse propagation From one group of cylinders to another. The optimum design will depend on

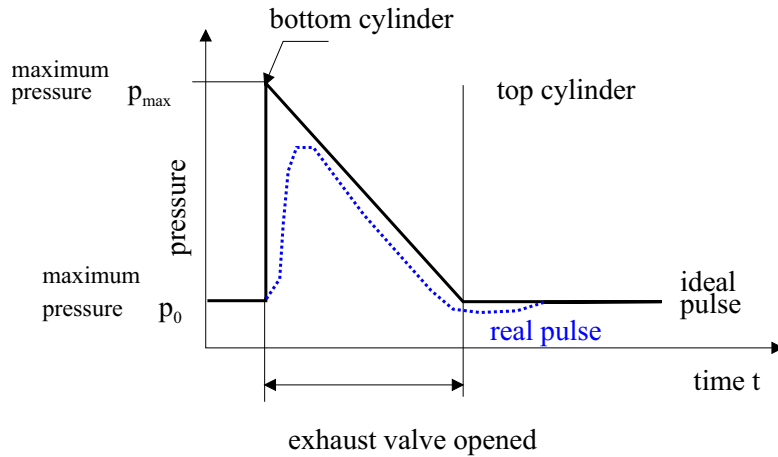
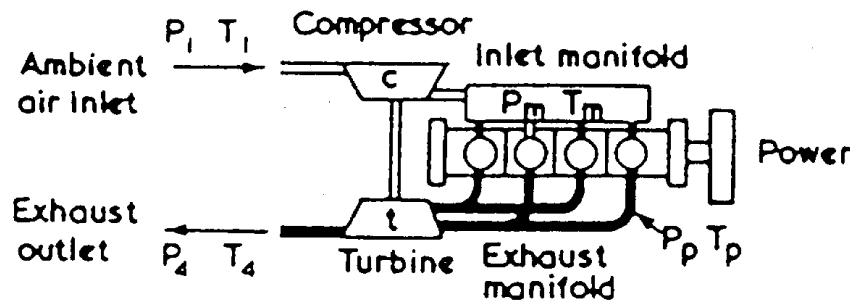

Figure 11.9. Pulse generation



Typical arrangement of a turbocharged engine operating with the pulse system.

Figure 11.10. Two-entry turbine inlet casing

the turbine, the exhaust pipe length, the valve timing, the number of cylinders, the engine speed etc.

Constant-pressure turbocharging (that is, when all exhaust ports enter a chamber at approximately constant pressure) is best for systems with a high pressure ratio. The dissipation of the pulse energy is offset by the improved turbine efficiency. Furthermore, during blown-down the throttling loss at the exhaust valve will be reduced. However, the part load performance of a constant-pressure system is poor because of the increased piston pumping work, and the positive pressure in the exhaust system can interfere with scavenging.

11.5 Energy available

Analyses (see below) show that the ideal power output is the same for

- a) complete expansion in the cylinder (§11.5.1)
- b) an Ideal Pulse Turbine (§11.5.2) but may be smaller from

c) a Constant Pressure Turbine (§11.5.3) because of irreversible losses at the exhaust valve, in this case there is a higher pressure in the cylinder throughout the exhaust stroke, which has two effects:

- Work done on the gas by the piston benefits the turbine
- Scavenge flow is inhibited during valve overlap.

11.5.1 EXPANSION ENERGY AVAILABLE AT EXHAUST RELEASE POINT

(From R. Saunders)

Suppose that a full isentropic expansion is possible between 4 and atmospheric condition 5 (e.g. extended stroke Atkinson cycle).

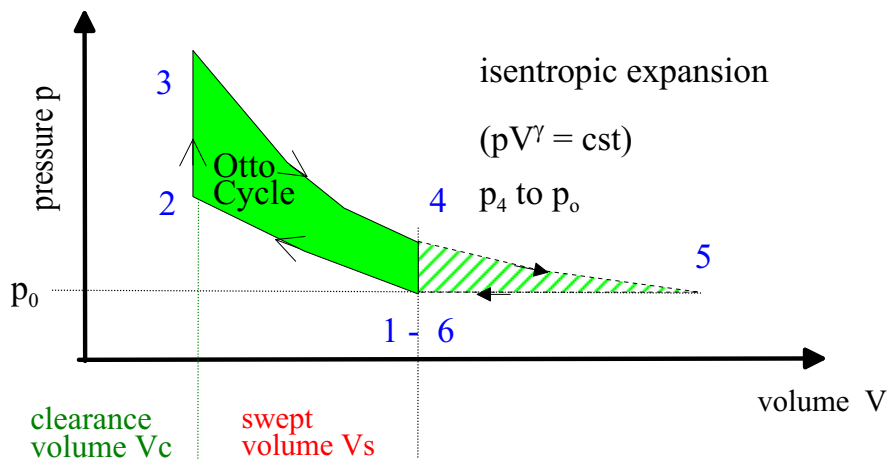

Figure 11.11. Expansion energy available

Additional work obtained would be:

$$W_{max} = \int_4^5 p dV + \int_5^6 p dV$$

that is for an isentropic expansion

$$W_{max} = \frac{p_4 V_4 - p_5 V_5}{\gamma - 1}$$

or using $p_5 = p_0$ and $V_6 = V_4$

$$W_{max} = p_0 V_4 \left[\frac{1}{\gamma - 1} \left(\frac{p_4}{p_0} \right) - \frac{\gamma}{\gamma - 1} \left(\frac{V_5}{V_4} \right) + 1 \right]$$

but also $V_4 = \frac{r}{r-1} V_5$ and $\left(\frac{V_5}{V_4} \right) = \left(\frac{p_4}{p_0} \right)^{1/\gamma}$ and

$$W_{max} = p_0 V_4 \left[1 + \frac{1}{\gamma - 1} \left(\frac{p_4}{p_0} \right) - \frac{\gamma}{\gamma - 1} \left(\frac{p_4}{p_0} \right)^{\frac{1}{\gamma}} \right]$$

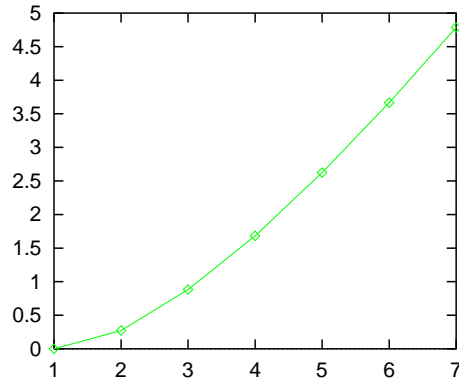

Figure 11.12. Maximum $\frac{p'_{em}}{p_0}$ as a function of $\frac{p_4}{p_0}$ available from exhaust gases, with $r \gg 1$

and if expressed in terms of equivalent mean effective pressure the maximum additional p'_{em} is

$$p'_{em} = \frac{W'_{max}}{V_s} = \frac{r}{r-1} p_0 \left[1 + \frac{1}{\gamma-1} \left(\frac{p_4}{p_0} \right) - \frac{\gamma}{\gamma-1} \left(\frac{p_4}{p_0} \right)^{\frac{1}{\gamma}} \right] \quad (11.7)$$

Hence

- i) Substantial work potential from exhaust.
- ii) Reverse of process 4-5-6 would be supercharging and the same analysis could be used.
- iii) But typically, if $\frac{p_4}{p_0} = 4$, $\frac{p'_{em}}{p_0} = 0.16$ while $\frac{v_5}{v_6} = 2.8$.

11.5.2 ENERGY AVAILABLE FROM AN ADIABATIC EXHAUST TURBINE: IDEAL PULSE TURBINE

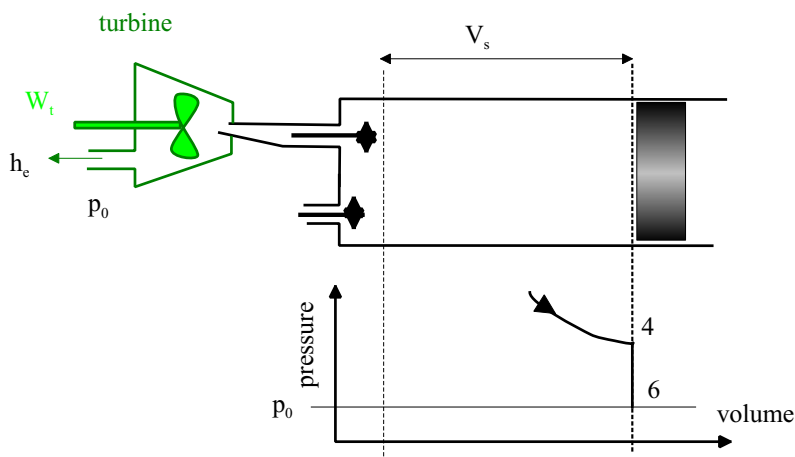

Figure 11.13. Expansion energy available

We will assume an isentropic expansion between 4 and 6. Here we are dealing with an unsteady flow process (see Cengel & Boles, 1998, §4.4 page 220). We will assume a uniform flow process with a stationary piston so that $h_e = h_6$ and $\frac{T_6}{T_4} = \left(\frac{p_0}{p_4} \right)^{\frac{\gamma-1}{\gamma}}$.

The energy equation for non-steady flows ((Cengel & Boles, 1998, 4-35) yields

$$Q + W_t - m_e h_e = U_6 - U_4$$

and mass conservation mass of gas: the mass of gas leaving the turbine m_e is equal to the mass lost in the cylinder during the expansion $m_4 - m_6$

$$m_e = m_4 - m_6 = \frac{p_4 V_4}{RT_4} - \frac{p_6 V_6}{RT_6} = \frac{V_4}{R} \left(\frac{p_4}{T_4} - \frac{p_0}{T_6} \right)$$

and

$$m_e h_e = m_e c_p T_6 = \frac{\gamma}{\gamma - 1} V_4 \left[p_4 \left(\frac{p_0}{p_4} \right)^{\frac{\gamma-1}{\gamma}} - p_0 \right]$$

Also

$$U_6 - U_4 = \frac{p_6 V_6 - p_4 V_4}{\gamma - 1} = \frac{V_4}{\gamma - 1} (p_0 - p_4)$$

Hence additional available mep is

$$p'_{em} = \frac{|W_t|}{V_s} = \frac{U_4 - U_6 - m_e h_e}{V_s} = \frac{V_4}{V_5} \left[\frac{p_4 - p_0}{\gamma - 1} - \frac{\gamma}{\gamma - 1} \left\{ \left(\frac{p_0}{p_4} \right)^{\frac{\gamma-1}{\gamma}} - p_0 \right\} \right]$$

$$p'_{em} = \frac{|W_t|}{V_s} = \frac{r}{r - 1} p_0 \left[1 + \frac{1}{\gamma - 1} \frac{p_4}{p_0} - \frac{\gamma}{\gamma - 1} \left(\frac{p_4}{p_0} \right)^{\frac{1}{\gamma}} \right]$$

11.5.3 ENERGY AVAILABLE FROM AN ADIABATIC EXHAUST TURBINE: CONSTANT PRESSURE EXHAUST MANIFOLD (4 STROKE)

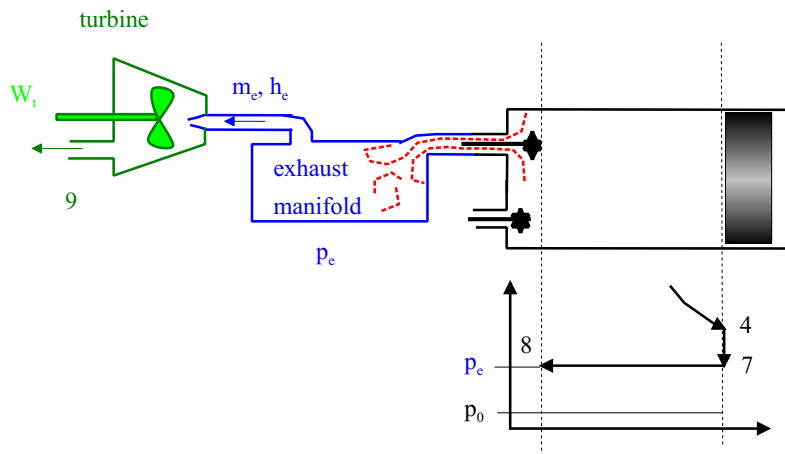

Figure 11.14. Energy available from a constant pressure exhaust manifold

- Energy equation for full EVO period: (boundary)

$$Q - W - m_e h_e = U_8 - U_4$$

$$\text{where } \begin{cases} W = -p_e V_s \\ h_e \text{ is averaged for exhaust} \\ U_e \text{ is unchanged from 8 to 4} \end{cases}$$

hence

$$m_e h_e = p_e V_s + \frac{p_4 V_4 - p_e V_c}{\gamma - 1}$$

- SFEE for the turbine only:

$$W_T = m_e (h_e - h_9) = m_e h_e \left(1 - \frac{h_9}{h_e} \right)$$

and if isentropic,

$$\frac{h_9}{h_e} = \frac{T_9}{T_e} = \left(\frac{p_o}{p_e} \right)^{\frac{\gamma-1}{\gamma}}$$

- Now net work is $W_t - V_s(p_e - p_o)$ for turbine + piston together full exhaust process. Hence

$$p'_{em} = \frac{W_{net}}{V_s} = \left(p_e + \frac{\frac{r}{r-1} p_4 - \frac{1}{r-1} p_e}{\gamma - 1} \right) \left(1 - \left(\frac{p_o}{p_e} \right)^{\frac{\gamma-1}{\gamma}} \right) - (p_e - p_o)$$

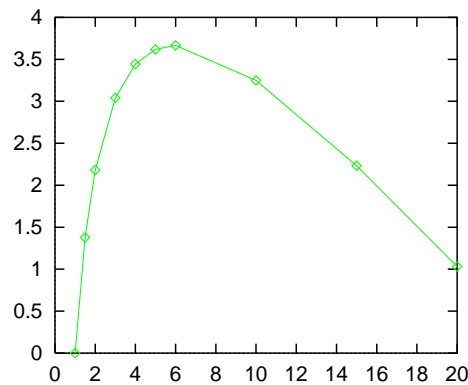

Figure 11.15. Maximum p'_{em} as a function of p_e for a constant pressure manifold, with $p_4 = 4$ bar and $r \gg 1$

Chapter 12: Turbocharging design and modelling

12.1 Design analysis

In principle there is a choice between

- constant pressure system
- pulse system

In practice a proper analysis of the pulse system for the purpose of turbocharger matching is too complex, and a 'quasi-steady' method is used. For this purpose,

- the effective exhaust pressure p_e cannot be measured because of pulsation, but since it depends on the flow capacity of the turbine it can be obtained from a turbine characteristic map, for a given actual mass flow rate of gas.
- The effective exhaust temperature T_e depends on processes in the engine cylinder. Two possible techniques are:
 - Simulate the full engine cycle including combustion to get the release temperature at EVO, and use section 12.3
 - Use an empirical method for gas temperature rise across the cylinder, based on experimental data for a given engine (section 12.4 and below).

12.2 Turbocharger power balance

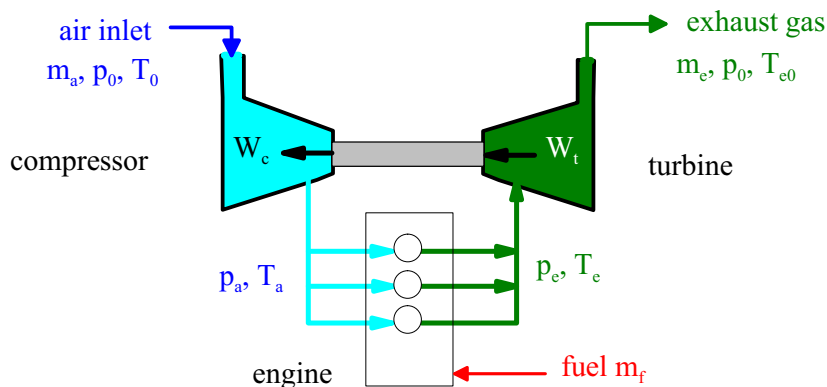

Figure 12.1. Turbocharger

1. The condition for a stable operation that is a constant turbine and compressor speed is

$$\dot{W}_t = \dot{W}_c$$

2. For a real turbine

$$\dot{W}_t = \eta_t \dot{m}_e (h_e - h_{e0s}) = \eta_t \dot{m}_e c_{pe} T_e \left\{ 1 - \left(\frac{p_0}{p_e} \right)^{\frac{\gamma_e - 1}{\gamma_e}} \right\}$$

NB

- a) T_e depends on engine processes
- b) p_e depends on turbine and \dot{m}_e
- c) η_t depends on turbine, \dot{m}_e , N_{tc} , pulse factor PF. e.g. we get p_e and η_{ts} from a steady flow turbine test and use

$$\eta_t = \text{PF} \cdot \eta_{ts}$$

where PF is an empirical factor called the pulse factor taking into account the pulse effect.

3. For a real compressor

$$\dot{W}_c = \frac{\dot{m}_a}{\eta_c} (h_{ac} - h_0)$$

that is

$$\dot{W}_c = \frac{\dot{m}_a}{\eta_c} c_{pa} T_0 \left[\left(\frac{p_a}{p_0} \right)^{\frac{\gamma_a - 1}{\gamma_a}} - 1 \right]$$

η_c depends on compressor, \dot{m}_a , p_a/p_0

4. $\dot{m}_e = \dot{m}_a + \dot{m}_f$ and $m_a = \eta_{tr} m_s$ we can also introduce f the mass ratio of fuel to air $f = \frac{m_f}{m_s}$, hence:

$$\dot{m}_e = \dot{m}_a (1 + f \eta_{tr})$$

For diesel, $\dot{m}_e = \dot{m}_a$ may be an adequate approximation otherwise typical values may be $f \leq 0.4$ and $\eta_{tr} \leq 0.9$.

12.3 Mean Temperature T_e from known cylinder release conditions

Energy: 1st Law for non-steady exhaust stroke:

$$Q - W - m_e h_e = U_8 - U_4$$

with $W = -p_e V_s$ Hence

$$m_e h_e = m_4 u_4 - m_8 u_8 + p_e V_s$$

Mass conservation:

$$m_e = m_4 - m_8$$

So that

$$h_e = c_p T_e = \frac{c_v \left(T_4 - \frac{m_8}{m_4} T_8 \right) + \frac{p_e V_s}{m_4}}{1 - \frac{m_8}{m_4}}$$

If the compression ratio is reasonably high, the effect of m_8/m_4 becomes small, and $m_4 \simeq \frac{p_4 V_s}{RT_4}$
Hence

$$\frac{T_e}{T_4} \simeq \frac{1}{\gamma} \left(1 + (\gamma - 1) \frac{p_e}{p_4} \right)$$

Typical example: $p_4 = 4$ bar, $T_4 = 800^\circ\text{C} = 1073$ K, $p_e = 1.8$ bar and $\gamma = 1.35$ would give
 $T_e = 0.857 T_4 = 920\text{K} = 647^\circ\text{C}$

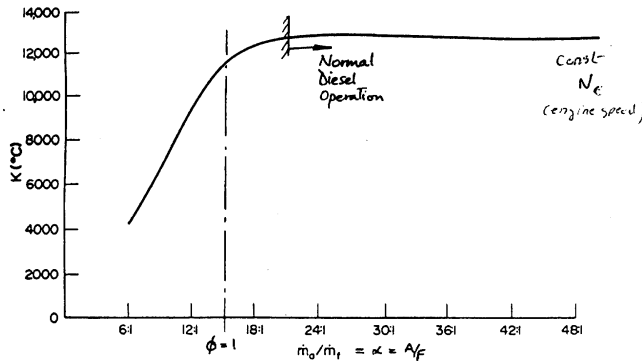

Figure 12.2. FIG. 10.11. Engine temperature rise factor K.

12.4 Empirical relationship for T_e

From SFEE for engine, fuel energy is

$$\dot{m}_f LCV = \dot{W}_E + \dot{Q}_C + \dot{m}_e c_{pe} (T_e - T_a)$$

$$\frac{\dot{m}_e c_{pe} (T_e - T_a)}{\dot{m}_f \times LCV} = 1 - \eta_{th} - L_C$$

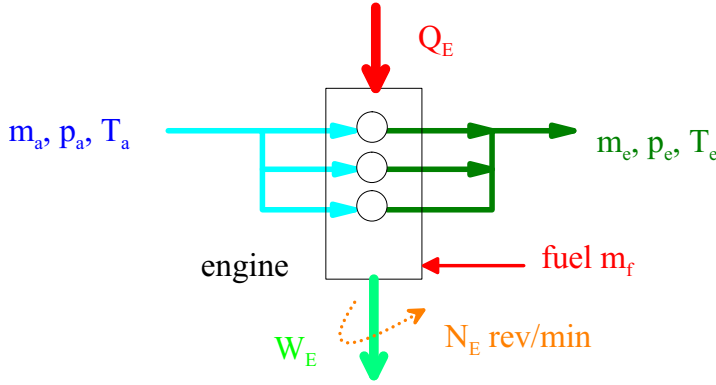

Figure 12.3. SFEE in the turbocharged engine

where $\eta_{th} = \frac{W_E}{\dot{m}_f \times LCV}$ and $L_C = \frac{Q_C}{\dot{m}_f \times LCV}$ both of which depend mainly on f and N_E for a given engine. Now,

$$\frac{\dot{m}_e}{\dot{m}_f} = \frac{\dot{m}_a + \dot{m}_f}{\dot{m}_f} = \alpha + 1 = \frac{1}{f\eta_{tr}} + 1$$

So

$$T_e - T_a = \frac{LCV}{c_{pe}}(1 - \eta_{th} - L_C) \left(\frac{1}{\alpha + 1} \right) = \frac{K}{\alpha + 1}$$

where $K = K(f, N_E)$ is an empirical factor for a given engine.

12.5 Example for a good diesel

$\eta_{th} = 0.38$, $L_C = 0.25$, $LCV = 42800 \text{ kJ.kg}^{-1}$, $c_{pe} = 1.15 \text{ kJ.kg}^{-1}.\text{K}^{-1}$ would give

$$T_e - T_a = \frac{13800}{\alpha + 1}$$

(approx valid when $\alpha > 18$)

when turbocharged, suppose $p_a = 2 \text{ bar}$ is required when $\alpha = 24$, $p_0 = 1 \text{ bar}$, $T_0 = 25^\circ\text{C}$, $\eta_c = 0.75$

Then the compressor gives

$$T_a = T_0 \left(1 + \frac{2^{\frac{2}{7}} - 1}{0.75} \right) = 298 \times 1.292 = 385 \text{ K}$$

and so

$$T_e = T_a + \frac{13800}{25} = 937 \text{ K}$$

Power balance requires

$$\eta_T \dot{m}_e c_{pe} T_e \left(1 - \left(\frac{p_0}{p_e} \right)^{\frac{\gamma_e - 1}{\gamma_e}} \right) = c_{pa} (T_a - T_0) \dot{m}_a$$

If $\eta_T = 0.7$ and $\gamma_e = 4/3$, then $\frac{p_e}{p_0} = 1.60$

12.6 Exercise

For a certain design of 4-stroke engine operating at a given overall air/fuel ratio, it is found that the i.m.e.p. and cylinder release pressure and temperature are each respectively proportional to the density, pressure and temperature of the air in the inlet manifold. A test of such an engine shows 10 bar i.m.e.p. and cylinder release conditions of 3.5 bar, 800°C when the inlet conditions are 1 bar, 30°C.

- (a) Find the equivalent i.m.e.p. and release conditions (turbine inlet and outlet) for the same air/fuel ratio when the engine is fitted with a turbocharger which compresses the air to 1.8 bar at cylinder inlet, and has an isentropic efficiency of 70% in both compressor and turbine.
- (b) Hence by assuming a constant pressure exhaust system, find the exhaust manifold pressure for steady conditions.

Neglect any flow of air through the engine as a result of valve overlap. Use $\gamma = 1.4$ for air, 1.333 for exhaust, and assume R is the same for both.

Answers: a) 14.28 bar, $p_e = 6.3$ bar, 1080°C, b) 1.35 bar

12.7 Exercise

For a certain turbocharged diesel engine, the averaged temperature rise from air manifold to exhaust gas manifold is given by

$$\Delta T = \frac{12000}{1 + A/F}$$

(T in °C) for $A/F \geq 18$ where A/F is the total mass ratio of air to fuel flow.

- (a) At a given load point at ambient conditions of 1 bar, 20°C, the A/F is 20 and the compressor delivers a boost pressure of 1.6 bar absolute with an isentropic efficiency (η_c) of 75%. Calculate the average turbine gas inlet temperature and the corresponding pressure required if the turbine isentropic efficiency (η_T) and Pulse Factor (PF) are assumed to be 65% and 1.2 respectively. Use $\gamma = 1.4$ for air, 4/3 for exhaust gas.
- (b) The same engine is also required to work at an altitude where the ambient conditions are 0.8 bar, 20°C. The fuel input mass and boost pressure (absolute) at the given load point are unchanged, but now $\eta_c = 0.70$, $\eta_T = 0.60$ and $PF = 1.0$. Calculate the new A/F and turbine inlet conditions, by assuming that air mass flow is proportional to compressed air density.

Answers: a) 921 K, 1.31 bar, b) 18.14, 1012 K, 1.366 bar

Chapter 13: Elements of turbomachinery

13.1 Dimensional analysis of compressible flows through turbomachines

For a given design, the essential variables from an external point of view may be written as

$$p_1, p_2, RT_1, RT_2, \dot{m}, N, D$$

where p and T are stagnation values

Note that

- 1) RT has dimension $L^2.t^{-2}$ ($t = \text{time}$)
- 2) Fixed gas composition is assumed (e.g. air)
- 3) Viscosity is omitted since the Reynolds number Re is assumed large (this is implied by compressible flow).

Only 3 fundamental dimensions are required L, t, M . Hence we expect $7 - 3 = 4$ independent groups:

$$\begin{array}{cccc} \pi_1 & \pi_2 & \pi_3 & \pi_4 \\ \hline \frac{p_2}{p_1} & \frac{T_2}{T_1} & \frac{\dot{m}\sqrt{RT_1}}{D^2 p_1} & \frac{ND}{\sqrt{RT_1}} \end{array}$$

Notes:

$$1) \eta_c, \eta_T = f(\pi_2, \pi_1) \text{ e.g. } \eta_c = \frac{\left(\frac{p_2}{p_1}\right)^{\frac{\gamma-1}{\gamma}} - 1}{\frac{T_2}{T_1} - 1}$$

$$2) \pi_3 \sim \frac{\dot{m}}{\rho A} \cdot \frac{1}{\sqrt{\gamma RT_1}} \sim \frac{c}{a_1} \text{ (where } \frac{c}{a_1} \text{ is the flow Mach number) but in practice graphs use}$$

$$\frac{\dot{m}\sqrt{T}}{p}$$

which is a dimensional mass flow parameter.

$$3) \text{ Similarly } \pi_4 \sim \frac{u_{max}}{a_1} \text{ is a rotor Mach number but in practice graphs use}$$

$$\frac{N}{\sqrt{T}}$$

which is used for the speed parameter.

$$4) \text{ Hence } \frac{\pi_4}{\pi_3} \sim \frac{u}{c}$$

13.2 Velocity limits in a compressor

Blade design is optimum for some velocity

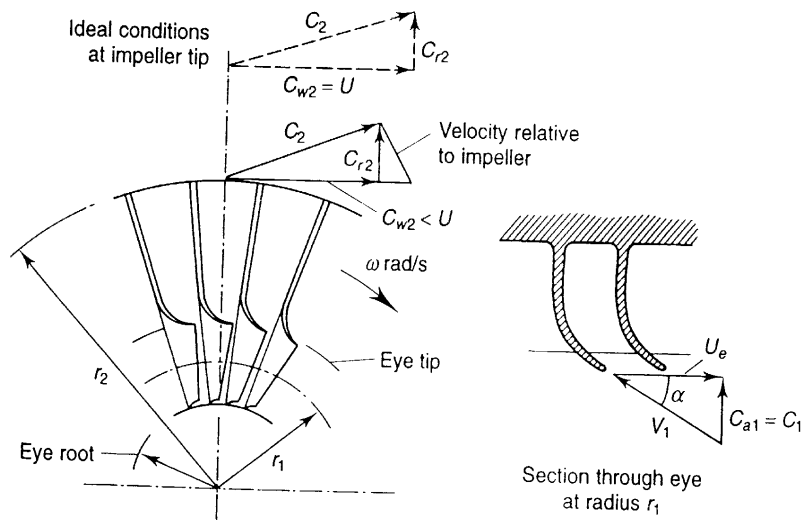
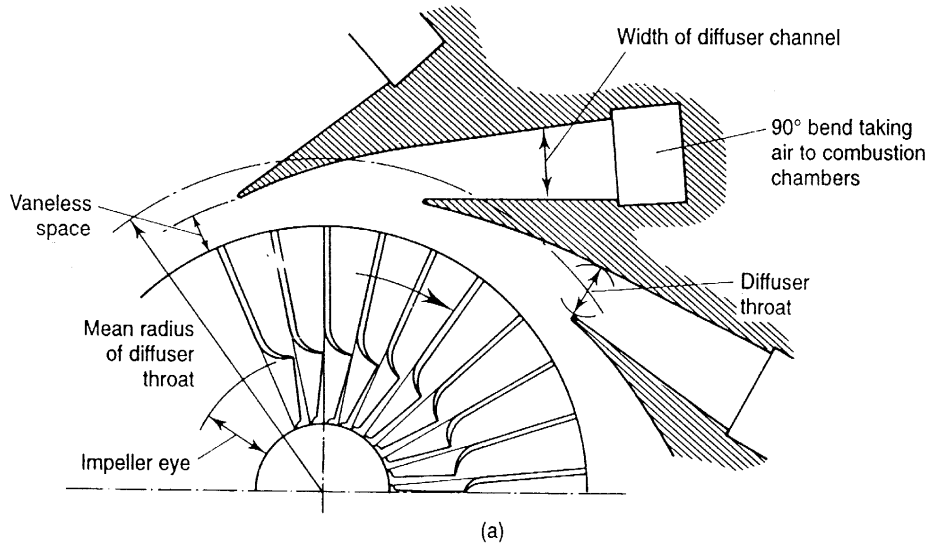

(From Cohen *et al.*, 1999, figures 4.1, 4.2)

Figure 13.1. Blade design

13.3 Compressor characteristic

(Cohen *et al.*, 1999, §4.6)

Let us consider what might be expected to occur when a valve, placed in the delivery line of a compressor *running at constant speed*, is slowly opened as illustrated in figure 13.2

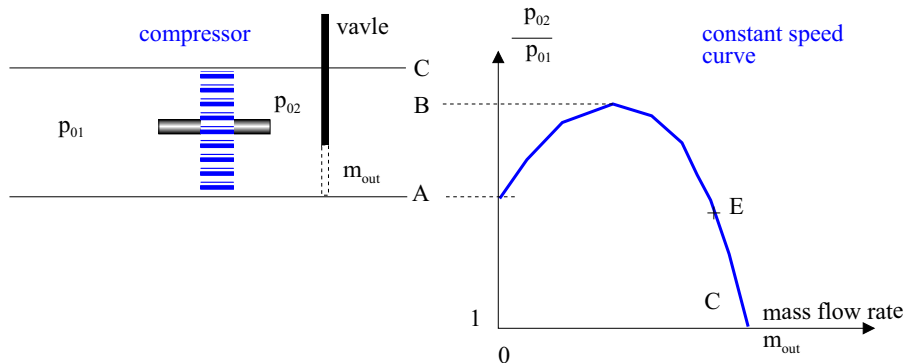

Figure 13.2. Compressor theoretical characteristic

- When the valve is shut and the mass flow is zero, the pressure ratio will reach some value A , corresponding to the centrifugal pressure head produced by the action of the impeller on the air trapped between the vanes.
- As the valve is opened and flow commences, the diffuser begins to contribute its quota of pressure rise, and the pressure ratio increases from A to B
- At some point B , where the efficiency approaches its maximum value, the pressure ratio will reach a maximum,
- and any further increase in mass flow will result in a fall of pressure ratio. For mass flows greatly in excess of that corresponding to the design mass flow, the air angles will be widely different from the vane angles, breakaway of the air will occur, and the efficiency will fall off rapidly.
- In this hypothetical case the pressure ratio drops to unity at C , when the valve is fully opened and all the power is absorbed in overcoming internal frictional resistance.
- There is an additional limitation to the operating range, between B and C . As the mass flow increases and the pressure decreases, the density is reduced and the radial component of velocity must increase. At constant rotational speed this must mean an increase in resultant velocity and hence in angle of incidence at the diffuser vane leading edge. Sooner or later, at some point (e.g. E), the position is reached where no further increase in mass flow can be obtained and choking is said to have occurred. This point represents the maximum delivery obtainable at the particular rotational speed for which the curve is drawn.

13.3.1 SURGE

In practice, most of the curve between *A* and *B* is unstable and can not be obtained and surging occurs.

Surging is associated with a sudden drop in delivery pressure, and with violent aerodynamic pulsation which is transmitted throughout the whole machine.

Surge is a total low instability of the compressor flow system, which may be expected to occur near the maximum pressure ratio of the characteristic but also depends on the flow dynamics of the upstream and down stream ducts.

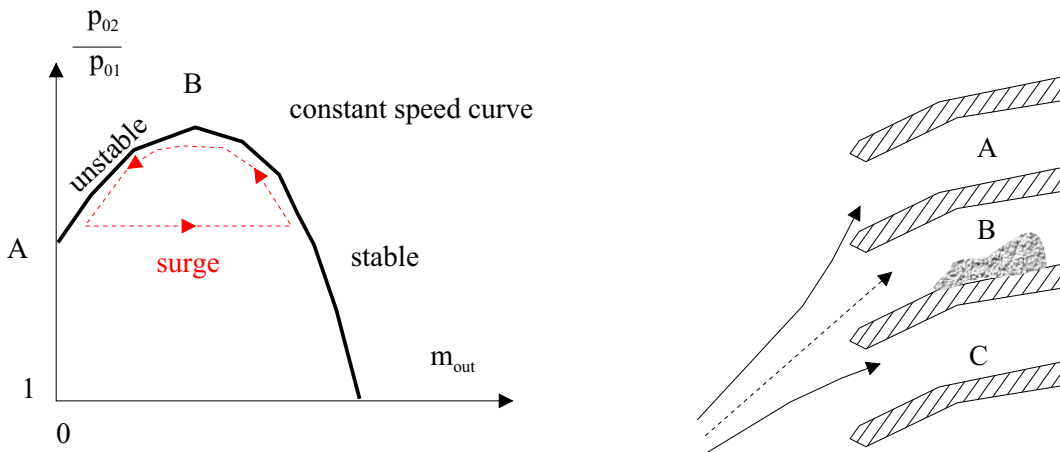

Figure 13.3. Surge and rotating stall

13.3.2 STALL

Another important cause of instability and poor performance is stall. Stall occurs when the flow separates from the leading edge of the rotor blades. It is a *local* instability of the flow, but may propagate from one blade to another blade as in rotating stall. When there is any non-uniformity in the flow or geometry of the channels between vanes or blades, breakdown in the flow in one channel, say *B* in figure 13.3, causes the air to be deflected in such a way that channel *C* receives fluid at a reduced angle of incidence and channel *A* at an increased incidence. Channel *A* then stalls, resulting in a reduction of incidence to channel *B* enabling the flow in that channel to recover. Thus the stall passes from channel to channel. Rotating stall may lead to aerodynamically induced vibrations resulting in fatigue failures in other parts of the gas turbine.

13.3.3 COMPRESSOR CHOICE

The compressor is characterised by the curves giving its efficiency η_c as a function of the pressure ratio $\frac{p_1}{p_2}$, the mass flow rate often given as $\dot{m} \frac{\sqrt{T}}{p}$ and the rotation rate often given as $\frac{N}{\sqrt{T}}$:

In order to choose the compressor we have to superimpose the engine characteristics onto the

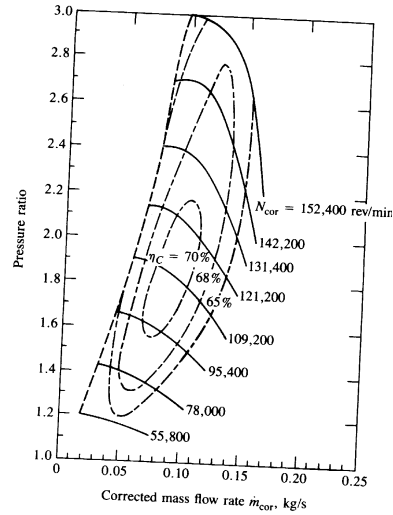
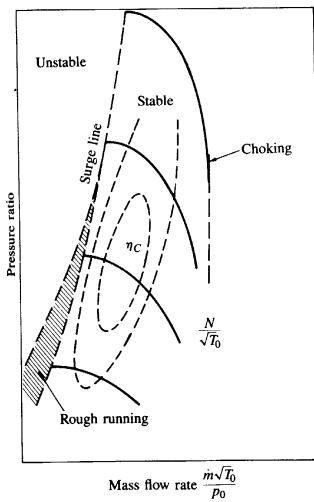

from (6.46, 6.47 Heywood, 1988)) p. 261-262

Figure 13.4. Compressor characteristic diagrams

compressor characteristics:

From Stone (1999)) figure 9.19 p. 392

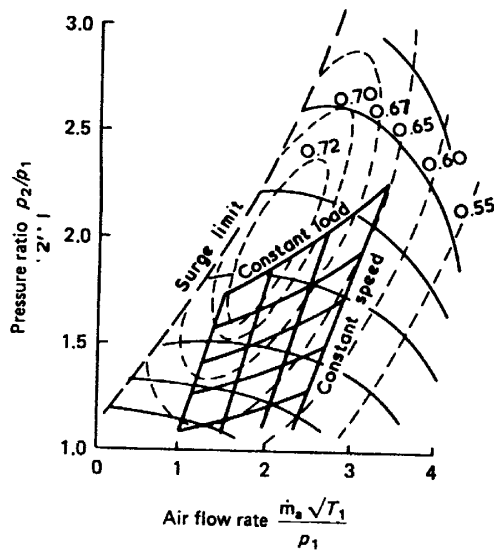

Figure 13.5. Compressor choice

13.4 Real effects in exhaust turbine Systems

Actual operation may require some compromise between pulse and constant pressure designs, depending on the number of cylinders and the engine duty.

- The ideal pulse system would have a turbine as close to the exhaust valve as possible, implying one turbine per cylinder; not only is this impractical but there would be windage

loss 75 % of the time for a 4 stroke engine.

- In practice several cylinders must be connected to the same turbine, so that the pulse energy is partly dissipated in the connecting pipe system as well as at the exhaust valve restriction.
- Many diesel engines benefit from a scavenge through-flow of air during an extended valve overlap period. This is only possible if $p_e \ll p_a$ during this time, and
 - a) each turbine entry is restricted to 2 or 3 cylinders unless pulse converters are used,
 - b) turbine housings then require divided inlet scrolls, leading to partial admission losses due to windage and end of sector effects.
- Turbine efficiency oscillates during each engine cycle as the gas velocity changes, so that
 - a) average $\eta < \max \eta$
 - b) apparent $\eta > \text{real} \eta$ because pulse pressure $>$ average pressure. For a well matched system (e.g. 6 cylinder engine with 3 cylinders per turbine entry), the effect of b) is usually greater than the combination of a) and the partial admission losses, particularly at low engine load. Hence Pulse Factor > 1
- Pulse converters can be used to allow more cylinders to feed one turbine entry, by preventing interference with scavenge.
- At high load and boost pressure¹, some large engines effectively operate with a constant pressure exhaust. If scavenge flow is not required, or for small engines at lower boost, a constant pressure design is simpler and cheaper.

¹The boost is the increase above atmospheric pressure of the induction pressure of a supercharged piston engine (Nayler, 1985).

Revision questionnaire of Part III

- 1) What is the role of a turbocharger?
- 2) Explain what are constant pressure system and pulse system.
- 3) Give the definition and explain what is the pulse factor PF.
- 4) What are surge and stall in the context of turbines?
- 5) What are the swirl and radial component in a compressor?

Part IV

Other reciprocating engines

Chapter 14: Rotary Engine (Wankel Engine)

See WebCT

Chapter 15: HCCI Engine

See WebCT

Revision questionnaire of Part IV

- 1) What is the main advantage of the Rotary or Wankel Engine
- 2) Describe the principle of HCCI engine

Conclusion

List of Figures

1.1	The four stroke operating cycle	19
1.2	Four stroke piston engine	19
1.3	Two stroke piston engine	20
1.4	Thermal efficiency	20
2.1	Wet exhaust gas species concentration as a function of fuel/air ϕ equivalence ratio	25
2.2	Concentration in CO and CO ₂ in the products (dry)	25
2.3	Energy of formation as a function of temperature	26
3.1	Example: heat exchange	32
4.1	Laminar premixed flame	37
4.2	Laminar flame speed as a function of ϕ at 1 bar	38
4.3	Diffusion flame	38
4.4	Tumble, Swirl and Squish	40
4.5	Flame shape in a turbulent flow	41
4.6	Turbulent velocity definition	41
4.7	Turbulent flame compared to laminar flame	42
4.8	Quenching near the walls	43
4.9	Diesel fuel spray combustion	43
4.10	Bunsen burner showing premixed and diffusion flames	44
5.1	Mass flux through the surface	45
5.2	External normal convention	46
5.3	Mass flux through an elementary surface $d\sigma$	46
5.4	The divergence theorem	48
5.5	Lagrangian derivative. The derivative is taken where the fluid particle is at time t .	50
5.6	Diffusion effect due to $\vec{\mathcal{V}}_\alpha > \vec{\mathcal{V}}_\beta$	51
5.7	Diffusion effect. On the left, there is no diffusion: the mass fraction of red remains constant on the fluid particle's trajectory. On the right, red and white species diffuse and their mass fractions change along the fluid particle's trajectory.	51
5.8	Altering energy in a control volume	54
5.9	Energy conservation in a control volume	55
5.10	Heat flux	56

5.11	Shear and pressure forces	57
5.12	Heat transfer due to mass transfer.	63
6.1	Swept volume for one cylinder	71
6.2	Mean effective pressure p_m	73
7.1	Otto Cycle	77
7.2	Otto cycle efficiency	78
7.3	Indicator diagram for a spark ignition engine	80
7.4	Effect of mixture equivalence ratio ϕ and flow velocity on minimum ignition energy for propane-air mixtures et 0.7 atm	82
8.1	Carburettor	86
8.2	Electronic fuel injection system	87
8.3	Spark engine performance	88
8.4	Formation of dissociate product	89
8.5	3-way catalyst	90
8.6	Gas exchange process	91
8.7	Admission valve	92
8.8	Electronic multipoint port fuel injection system L-Jelectronic system	94
9.1	Diesel cycle	97
9.2	Diesel sequence	98
9.3	CI and SI ϕ régimes	101
9.4	Comparison of the part load efficiency of engines at 2000 rpm (Stone, R.) spark ignition and Diesel	102
10.1	Two stroke piston engine - scavenging	103
10.2	Scavenge process in a two stroke engine	105
10.3	Perfect displacement scavenging	106
10.4	Complete mixing scavenging, as a function of λ	107
10.5	Short circuit scavenging	107
10.6	Combined scavenge model	108
11.1	Supercharging (left) and turbocharging (right)	115
11.2	Examples of superchargers, Roots blower, vane compressor, screw compressor	116
11.3	Schematic of turbocharged engine system	116
11.4	Example of turbochargers, left axial compressor right radial compressor	117
11.5	Enthalpy as a function of entropy diagram for a turbocharger	118

11.6	Typical arrangement of a constant pressure system	119
11.7	Constant pressure system for several cylinders	120
11.8	Typical arrangement for pulse system	120
11.9	Pulse generation	121
11.10	Two-entry turbine inlet casing	121
11.11	Expansion energy available	122
11.12	Maximum $\frac{p'_{em}}{p_0}$ as a function of $\frac{p_4}{p_0}$ available from exhaust gases, with $r \gg 1$	123
11.13	Expansion energy available	123
11.14	Energy available from a constant pressure exhaust manifold	124
11.15	Maximum p'_{em} as a function of p_e for a constant pressure manifold, with $p_4 = 4$ bar and $r \gg 1$	125
12.1	Turbocharger	127
12.2	FIG. 10.11. Engine temperature rise factor K.	129
12.3	SFEE in the turbocharged engine	130
13.1	Blade design	134
13.2	Compressor theoretical characteristic	135
13.3	Surge and rotating stall	136
13.4	Compressor characteristic diagrams	137
13.5	Compressor choice	137

Data sheets

Data provided

Graph paper (if needed)

Steam table

Data book

Documents provided

Combustion temperature rise chart

Formulae

Scavenge ratio or delivery ratio λ

$$\lambda = \frac{m_s}{m_i}$$

Scavenge efficiency η_{sc}

$$\eta_{sc} = \frac{m_a}{m_a + m_g}$$

Charging efficiency η_{ch}

$$\eta_{ch} = \frac{m_a}{m_i}$$

Trapping efficiency η_{tr}

$$\eta_{tr} = \frac{m_a}{m_s} = \frac{\eta_{ch}}{\lambda}$$

Where we used the following definition

- v_t : cylinder trapping volume
- m_i : ideal trapped air mass = $\rho_s V_t$
- m_a : actual air mass in the cylinder
- m_g : mass of residual gas in the cylinder
- m_s : mass of air supplied to the cylinder

Perfect displacement : $\eta_{ch} = \lambda$

Perfect mixing : $d\eta_{ch} = d\lambda(1 - \eta_{ch})$

Short circuit : $d\eta_{ch} = 0$

- Compressor polytropic efficiency

$$\frac{T_{02}}{T_{01}} = \left(\frac{p_{02}}{p_{01}} \right)^{\frac{\gamma-1}{\gamma\eta_{\delta c}}}$$

- Turbine polytropic efficiency

$$\frac{T_{04}}{T_{03}} = \left(\frac{p_{04}}{p_{03}} \right)^{\frac{\gamma-1}{\gamma}\eta_{\delta t}}$$

- **Choked nozzle**

$$T_5 = \frac{2}{\gamma + 1} T_{04}, \quad \mathcal{V}_5 = \sqrt{\gamma R T_5}$$

T_5 static temperature of the jet, T_{04} total temperature after the turbine.

- **Propulsive thrust**

$$\eta_p = \frac{\text{thrust power}}{\text{total power}}$$

- **Intake nozzle efficiency**

$$\eta_i = \frac{T_{01'} - T_a}{T_{01} - T_a}$$

- **propelling nozzle efficiency**

$$\eta_j = \frac{T_{04} - T_5}{T_{04} - T_{5'}}$$

Course Work

Introduction

You have to write a small report on a the 2-hour seminar given by Pr G. Kalghatgi.

Sustainable transport fuels for the future

6th December 2006 14:00 - 16:00

in SG LT14

Attendance is compulsory and an attendance list will be circulating.

The report should be between 3 to 5 pages including figures. The manuscript should be technically well-written and organised. It should be your own work, not a compilation or scanning of different book sections and web pages. Try to digest what has been done and present it in your own words. Discuss information you gathered in a critical manner, as information coming from different sources can be inconsistent or contradictory. Not being able to understand what has been done, but attempting to know why can indicate maturity rather than lack of intelligence or knowledge. The main purpose of this exercise is to train you to analyse and synthesise information and show your ability to carry out literature survey.

Format

TITLE

Please have information as follows on the first page

- Module title and reference
- Lecturer's name (in case your report get misplaced)
- Your name and email
- Your course (e.g. MEng., Erasmus, ...)

There is no a priori good or bad way to write a report. As long as you have valid reasons for your report presentation. The model that follows is indicative and only here to help you.

ABSTRACT or summary

INTRODUCTION & BACKGROUND

Briefly describe what you are presenting and why it is important.

STATE OF THE ART

The different designs or technologies. Their historic development. The current trends, the future trends.

State what you think are their shortcomings

State concisely and specifically the researches that address one or more of the problems you have cited.

REFERENCES

List carefully your references. You can find the books cited in this course at Saint Georges' library. But you can carry out your own literature survey and find much more.

Deadline and submission

You can submit your report in hand or send it by email if you choose to type it. Deadline is fixed to week 12, Friday 15th December 2006 by 17.00. Late submission will be penalised. There is no way I can know if a report is missing but I will acknowledge all reception by email (in January). It is your responsibility to ensure that I got the report.

Solutions to exercises

Exercises of Chapter 2

Exercise §2.1.1

A)



Balance of

$$\text{C} : 8 = n_{\text{CO}_2} \quad n_{\text{CO}_2} = 8$$

$$\text{H} : 18 = 2n_{\text{H}_2\text{O}} \quad n_{\text{H}_2\text{O}} = 9$$

$$\text{O} : 2n_a = 2n_{\text{CO}_2} + n_{\text{H}_2\text{O}} \quad n_a = \frac{25}{2}$$

Hence stoichiometric equilibrium is:

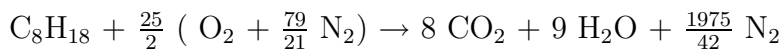

Stoichiometric fuel/air (mass) ratio:

$$f_{st} = \frac{\text{mass of fuel}}{\text{mass of air}} = \frac{12 \times 8 + 18}{\frac{25}{2} \left(2 \times 16 + \frac{79}{21} \times 2 \times 14 \right)} = \frac{114}{\frac{5150}{3}} = \frac{342}{5150} = 0.0664$$

B)

Use Rogers & Mayhew (1998) page 21

$$\Delta \tilde{h} = -5116180 \text{ kJ.kmol}^{-1}$$

Hence

$$\Delta h = f_{st} \frac{1}{\tilde{m}_f} \Delta \tilde{h} = 0.0664 \times \frac{1}{\underbrace{8 \times 12 + 18}_{\text{mol.g}^{-1}}} \times \underbrace{5116180}_{\text{J.mol}^{-1}} \text{ J.g}^{-1} \text{ of air}$$

$$\Delta h = -2979.95 \text{ kJ.kg}^{-1} \text{ of air}$$

(note the convention sign – indicates energy is released to the exterior)

C)

If all liquid

$$\Delta \tilde{h} = -5116180 + \tilde{h}_{fg}(\text{C}_8\text{H}_{18}) - 9 \times \tilde{h}_{fg}(\text{H}_2\text{O})$$

$$\Delta \tilde{h} = -5116180 + 41500 - 9 \times 43990 = -5470590 \text{ kJ.kmol}^{-1}$$

$$\Delta h = 0.0664 \times \frac{1}{8 \times 12 + 18} \times (-5470590) = -3186 \text{ kJ.kg}^{-1}$$

E)

$$\Delta H - \Delta U = \Delta(pV) = (n_P - n_R)\tilde{R}T$$

which for 1 kmol of octane is $3.5 \times 8.3145 \times 298 = 8672 \text{ kJ.kmol}^{-1}$ i.e.

$$\Delta u = \Delta h - \Delta(pV) = -2980 - 5 = -2985 \text{ kJ per kg of air}$$

Exercises of Chapter 3

Exercise §3.5.3

A)

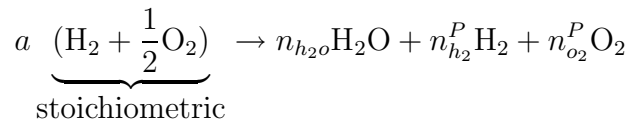

5 % of the original H_2 remains uncombined: $n_{\text{H}_2}^P = 0.05a$

Balance of

$$\text{H} : a = n_{\text{H}_2} + n_{\text{H}_2\text{O}} \quad n_{\text{H}_2\text{O}} = a - 0.05a = 0.95a$$

$$\text{O} : a = n_{\text{H}_2\text{O}} + 2n_{\text{O}_2} \quad n_{\text{O}_2} = \frac{1}{2}(1 - 0.95)a = 0.025a$$

We have equilibrium in the products as follows

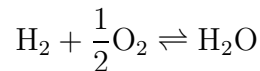

$$K^\ominus(T) = \frac{p_{\text{H}_2\text{O}}}{p_{\text{H}_2} (p_{\text{O}_2})^{\frac{1}{2}}} (p^\ominus)^{\frac{1}{2}}$$

$$\text{With } \begin{cases} p_{\text{H}_2} &= \frac{n_{\text{H}_2}}{n^P} p_P &= \frac{0.05}{1.025} p_P &= 0.0488 \times p_P \\ p_{\text{O}_2} &= \frac{n_{\text{O}_2}}{n^P} p_P &= \frac{0.025}{1.025} p_P &= 0.0244 \times p_P \\ p_{\text{H}_2\text{O}} &= \frac{n_{\text{H}_2\text{O}}}{n^P} p_P &= \frac{0.95}{1.025} p_P &= 0.927 \times p_P \end{cases}$$

where $n^P = n_{\text{H}_2\text{O}} + n_{\text{H}_2}^P + n_{\text{O}_2}^P = (0.05 + 0.95 + 0.025)a = 1.025a$. Hence

$$K^\ominus(T) = \frac{0.927}{0.0488 \times 0.0244^{\frac{1}{2}}} \times \left(\frac{1}{10}\right)^{\frac{1}{2}} = 38.46$$

B)

Looking in table (Rogers & Mayhew, 1998) page 21 for T such that

$$K^\ominus(T) = 38.5 \text{ i.e. } \ln K^\ominus(T) = 3.65$$

we find $T = 2844 \text{ K}$

C)

Initially $T_R = 25^\circ\text{C} = 298 \text{ K}$. If we assume ideal gas

$$p_R V = n^R \tilde{R} T_R$$

and

$$p_P V = n^P \tilde{R} T_P$$

both mixtures, reactants and products, are in the same volume V , hence

$$\frac{p_R}{p_P} = \frac{n^R T_R}{n^P T_P}$$

that is

$$p_R = \frac{n^R T_R}{n^P T_P} p_P = \frac{(1 + \frac{1}{2})a}{1.025a} \times \frac{298}{2844} \times 10 = 1.53 \text{ bar}$$

D)

For a close volume first law of thermodynamics is

$$\Delta U = Q - W$$

with here $W = 0$ the heat gained by the bomb per kmol of H_2 is

$$\tilde{q} = \Delta \tilde{u} = \Delta \tilde{h} - \Delta(pV) = \Delta \tilde{h} - \Delta(n \tilde{R} T) = \Delta \tilde{h} - \tilde{R}(n_P T_P - n_R T_R)$$

Only 95 % of the initial number of moles of H_2 has reacted and the products are at the temperature $T_P = 2844$ K. Hence

$$\Delta \tilde{h} = 0.95 \Delta \tilde{h}^\circ + n_{h_2o} \Delta \tilde{h}(H_2O)_{298 \rightarrow 2844} + n_{h_2} \Delta \tilde{h}(H_2)_{298 \rightarrow 2844} + n_{o_2} \Delta \tilde{h}(O_2)_{298 \rightarrow 2844}$$

$$\Delta \tilde{h} = 0.95 \times (-241\,830) + 0.95 \times 117\,725 + 0.05 \times 82\,992 + 0.025 \times 91\,893 = -111\,452 \text{ kJ.kmol}^{-1}$$

so that

$$\tilde{q} = -111\,452 - 8.3145 \times (1.025 \times 2844 - 1.5 \times 298) = 131\,973 \text{ kJ per kmol of } H_2$$

and dividing by the molar mass of H_2 that is 2 kg.kmol^{-1}

$$q = 65\,986 \text{ kJ.kg}^{-1}$$

Exercise §3.5.4

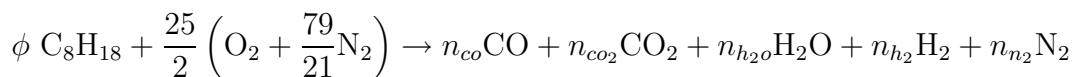

Balance of

$$\begin{aligned} \text{N} : \quad \frac{25}{2} \times \frac{79}{21} &= n_{n_2} & \Rightarrow n_{n_2} &= \frac{1975}{42} \\ \text{H} : \quad 18\phi &= 2n_{h_2o} + 2n_{h_2} & \Rightarrow n_{h_2o} &= 9\phi - n_{h_2} \\ \text{C} : \quad 8\phi &= n_{co} + n_{co_2} & \Rightarrow n_{co} &= 25(\phi - 1) - n_{h_2} \\ \text{O} : \quad 25 &= n_{co} + 2n_{co_2} + n_{h_2o} & \Rightarrow n_{co_2} &= 25 - 17\phi + n_{h_2} \end{aligned}$$

We need an additional relation to close the problem. We have the equilibrium at 1200 K in the products

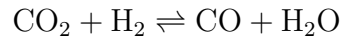

Which yields:

$$K^\ominus(1200 \text{ K}) = \frac{p_{\text{H}_2\text{O}} p_{\text{CO}}}{p_{\text{H}_2} p_{\text{CO}_2}} = e^{0.311} = 1.3648$$

that is

$$K^\ominus = \frac{\frac{n_{\text{H}_2\text{O}}}{n^P} \times \frac{n_{\text{CO}}}{n^P}}{\frac{n_{\text{H}_2}}{n^P} \times \frac{n_{\text{CO}_2}}{n^P}} = \frac{n_{\text{H}_2\text{O}} \times n_{\text{CO}}}{n_{\text{H}_2} \times n_{\text{CO}_2}}$$

Hence we have to solve for n_{H_2}

$$(25(\phi - 1) - n_{\text{H}_2})(9\phi - n_{\text{H}_2}) - K^\ominus(1200 \text{ K})(-17\phi + 25 + n_{\text{H}_2})n_{\text{H}_2} = 0$$

or with $\phi = 1.1$

$$(2.5 - n_{\text{H}_2})(9.9 - n_{\text{H}_2}) - 1.3648(6.3 + n_{\text{H}_2})n_{\text{H}_2} = 0$$

We find $n_{\text{H}_2} = 1.156$ and

$$\left\{ \begin{array}{l} n_{\text{CO}} = 1.344 \\ n_{\text{CO}_2} = 7.456 \\ n_{\text{H}_2\text{O}} = 8.744 \\ n_{\text{N}_2} = 47.02 \\ n^P = n_{\text{H}_2} + n_{\text{CO}} + n_{\text{CO}_2} + n_{\text{H}_2\text{O}} + n_{\text{N}_2} \\ \quad = 1.156 + 1.344 + 7.456 + 8.744 + 47.02 = 65.72 \end{array} \right.$$

Hence

$$\left\{ \begin{array}{l} x_{\text{H}_2} = \frac{n_{\text{H}_2}}{n^P} = 1.76\% \\ x_{\text{CO}} = \frac{n_{\text{CO}}}{n^P} = 2.04\% \\ x_{\text{CO}_2} = \frac{n_{\text{CO}_2}}{n^P} = 11.3\% \\ x_{\text{H}_2\text{O}} = \frac{n_{\text{H}_2\text{O}}}{n^P} = 13.3\% \\ x_{\text{N}_2} = \frac{n_{\text{N}_2}}{n^P} = 71.6\% \end{array} \right.$$

Exercise §3.5.5

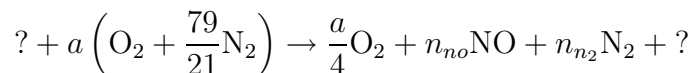

Balance of

$$\text{N} : a \frac{79}{21} = n_{\text{N}_2} + n_{\text{no}}$$

In the products we have equilibrium for the reaction

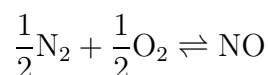

Hence

$$K^\ominus(2200 \text{ K}) = \frac{p_{NO}}{(p_{N_2})^{\frac{1}{2}} (p_{O_2})^{\frac{1}{2}}}$$

that is

$$K^\ominus(2200 \text{ K}) = \frac{n_{no}}{(n_{n_2})^{\frac{1}{2}} (n_{o_2})^{\frac{1}{2}}}$$

or

$$K^\ominus(2200 \text{ K}) = \frac{n_{no}}{(n_{n_2})^{\frac{1}{2}} (n_{o_2})^{\frac{1}{2}}}$$

that is when substituting for n_{o_2} and n_{n_2}

$$(K^\ominus(2200 \text{ K}))^2 \frac{a}{4} \left(\frac{79}{21} a - n_{no} \right) = (n_{no})^2 \quad (15.1)$$

The proportion of nitrogen N_2 converted into NO is $\frac{n_{no}}{a \frac{79}{21}}$ dividing both sides of equation (15.1) yields:

$$(K^\ominus(2200 \text{ K}))^2 \frac{1}{4} \left(\frac{79}{21} - \frac{n_{no}}{a} \right) = \left(\frac{n_{no}}{a} \right)^2$$

we have to solve

$$0.0328^2 \left(3.76 - \frac{n_{no}}{a} \right) = \left(\frac{n_{no}}{a} \right)^2$$

we find $\frac{n_{no}}{a} = 0.0317$ so that $0.0317 / \frac{79}{21} = 8.42 \%$ of initial N_2 has been converted into NO (or 4.21 % of initial N).

Exercise §3.5.6

A)

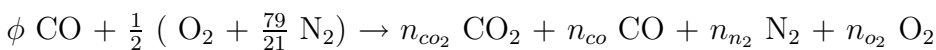

Balance of

$$\text{C} : \quad \phi = n_{CO_2} + n_{CO} \quad (1)$$

$$\text{O} : \quad \phi + 1 = 2n_{CO_2} + n_{CO} + 2n_{O_2} \quad (2)$$

$$\text{N} : \quad n_{N_2} = \frac{79}{42} \quad (3)$$

With $\phi = 1.1$ (10 % rich mixture) we are left with 3 unknowns:

n_{CO_2} , n_{CO} and n_{O_2} and two equations (1) and (2)

the products resulting from the combustion are in equilibrium at 3000 K and $p_P = 40$ bar, hence:



$$K^\ominus(3000 \text{ K}) = \frac{p_{CO_2} (p^\ominus)^{\frac{1}{2}}}{p_{CO} (p_{O_2})^{\frac{1}{2}}} \quad (15.2)$$

is the closing equation to solve for the 3 unknown coefficients. Partial pressure are related to the total pressure p_P :

$$\begin{cases} p_{CO_2} &= \frac{n_{CO_2}}{n^P} p_P \\ p_{O_2} &= \frac{n_{O_2}}{n^P} p_P \\ p_{CO} &= \frac{n_{CO}}{n^P} p_P \end{cases}$$

where n^P is the total number of moles in the products $n^P = n_{CO_2} + n_{O_2}^P + n_{CO}^P + n_{N_2}^P$ equation (15.2) becomes

$$K^\ominus(3000 \text{ K}) = \frac{\frac{n_{CO_2}}{n^P} p_P (p^\ominus)^{\frac{1}{2}}}{\frac{n_{CO}^P}{n^P} p_P \left(\frac{n_{O_2}}{n^P}\right)^{\frac{1}{2}} p_P^{\frac{1}{2}}}$$

that is

$$K^\ominus = \frac{n_{CO_2}}{n_{CO}^P} \times \left(\frac{n^P}{n_{O_2}}\right)^{\frac{1}{2}} \times \left(\frac{p^\ominus}{p_P}\right)^{\frac{1}{2}}$$

or

$$K^{\ominus 2} (n_{CO}^P)^2 n_{O_2} = (n_{CO_2})^2 n^P \left(\frac{p^\ominus}{p_P}\right) \quad (15.3)$$

We have three unknowns and three equations let us choose to solve for n_{CO_2} and substitute the other unknowns. We have

$$\begin{aligned} \text{from (1)} \quad & n_{CO} = \phi - n_{CO_2} \\ \text{from (1) and (2)} \quad & n_{O_2} = \frac{1-n_{CO_2}}{2} \\ \text{then} \quad & n^P = \phi + n_{N_2} + \frac{1-n_{CO_2}}{2} \end{aligned}$$

Substituting in equation (15.3):

$$(K^\ominus)^2 (n_{CO_2})^2 \left(\frac{1-n_{CO_2}}{2}\right) = (n_{CO_2})^2 \left(\phi + n_{N_2} + \frac{1-n_{CO_2}}{2}\right) \left(\frac{p^\ominus}{p_P}\right)$$

Hence we have to solve:

$$(3.034)^2 (1-n_{CO_2})(1.1-n_{CO_2})^2 - (n_{CO_2})^2 (6.96-n_{CO_2}) \frac{1}{40} = 0$$

Try some values until convergence $\rightarrow n_{CO_2} = 0.835$ mol then

$$\begin{aligned} n_{CO} &= 0.265 \\ n_{O_2} &= 0.0825 \\ n^P &= 3.06 \end{aligned}$$

For 1.1 mol of CO supplied 0.265 are present in the products that is 24 % and the molar gas composition is:

$$\begin{aligned} x_{CO_2} &= \frac{0.835}{3.06} = 27.3\% \\ x_{CO} &= \frac{0.265}{3.06} = 8.7\% \\ x_{O_2} &= \frac{0.0825}{3.06} = 2.7\% \\ x_{N_2} &= \frac{1.88}{3.06} = 61.5\% \end{aligned}$$

B)

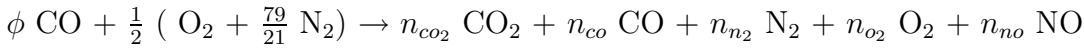

Balance of

$$\text{C} : \quad \phi = n_{\text{CO}_2} + n_{\text{CO}} \quad (1)$$

$$\text{O} : \quad \phi + 1 = 2n_{\text{CO}_2} + n_{\text{CO}} + 2n_{\text{O}_2} + n_{\text{NO}} \quad (2)$$

$$\text{N} : \quad 2n_{\text{N}_2} + n_{\text{NO}} = \frac{79}{21} \quad (3)$$

With $\phi = 1.1$ (10 % rich mixture) we are left with 5 unknowns:

n_{CO_2} , n_{CO} , n_{O_2} , n_{N_2} and n_{NO} and three equations (1), (2) and (3)

• there still is equilibrium for CO:

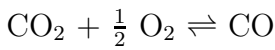

and equation (15.3) still holds but now $n^P = n_{\text{CO}_2} + n_{\text{CO}}^P + n_{\text{O}_2}^P + n_{\text{N}_2}^P + n_{\text{NO}}$

• There is also equilibrium for NO

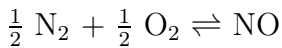

and the additional equation needed to close the problem is

$$K_{n_2}^\ominus (3000 \text{ K}) = \frac{p_{\text{NO}}}{(p_{\text{O}_2})^{\frac{1}{2}} (p_{\text{N}_2})^{\frac{1}{2}}} = \frac{n_{\text{NO}}}{(n_{\text{O}_2})^{\frac{1}{2}} (n_{\text{N}_2})^{\frac{1}{2}}}$$

That is

$$(K_{n_2}^\ominus)^2 n_{\text{O}_2} n_{\text{N}_2} = (n_{\text{NO}})^2 \quad (15.4)$$

We can choose to keep n_{CO_2} and n_{NO} and substitute other unknowns in equations (15.4) and (15.3)

we end up with:

$$(K_{n_2}^\ominus)^2 (1 - n_{\text{CO}_2} - n_{\text{NO}}) \left(\frac{79}{21} - n_{\text{NO}} \right) = 4 (n_{\text{NO}})^2 \quad (15.5)$$

and

$$(K_{\text{CO}_2}^\ominus)^2 (1 - n_{\text{CO}_2} - n_{\text{NO}}) (\phi - n_{\text{CO}_2})^2 = (n_{\text{CO}})^2 \left\{ 2\phi + \frac{79}{21} + (1 - n_{\text{CO}_2}) \right\} \frac{1}{40} \quad (15.6)$$

We can use previous value for n_{CO_2} (0.835) in (15.5) and find n_{NO} value for which (15.5) is verified:

$$n_{\text{NO}} = 0.0414$$

we then use this value in (15.6) to get update the value for n_{CO_2} , we get:

$$n_{\text{CO}_2} = 0.818$$

then carry on until convergence of n_{NO} and n_{CO_2} , i.e. use $n_{\text{CO}_2} = 0.818$ in (15.5) it yields

$$n_{\text{NO}} = 0.0438$$

and then use $n_{no} = 0.0438$ in (15.6) it yields

$$n_{co_2} = 0.817$$

Considering these two latter values as converged we get:

$$\begin{aligned} n_{co}^P &= \phi - n_{co_2} &= 1.1 - 0.817 = 0.283 \\ n_{n_2}^P &= \frac{1}{2} \left(\frac{79}{21} - n_{no} \right) &= 1.859 \\ n_{o_2}^P &= \frac{1}{2} (1 - n_{co_2} - n_{no}) &= 0.0696 \\ n^P &= 0.817 + 0.283 + 1.859 + 0.00696 + 0.0438 &= 3.0724 \end{aligned}$$

For 1.1 mol of CO in the reactants there are 0.283 mol in the products that is 25.7% and the molar gas composition is

$$\begin{aligned} x_{co_2} &= \frac{0.817}{3.0724} = 26.6\% \\ x_{co} &= \frac{0.283}{3.07} = 9.2\% \\ x_{o_2} &= \frac{0.0696}{3.07} = 2.26\% \\ x_{n_2} &= \frac{1.859}{3.07} = 60.5\% \\ x_{no} &= \frac{0.0438}{3.07} = 1.4\% \end{aligned}$$

Exercises of Chapter 6

Exercise §6.3

A)

The brake mean effective pressure is defined as

$$p_{bm} = \frac{W_b}{V_s}$$

with

$$W_b = \eta_{thb} \times m_{fuel} \times LCV$$

where

$$m_{fuel} = \frac{m_{air}}{\alpha} = \eta_{vol} \times \rho_{air} \frac{1}{\alpha} V_s$$

Hence

$$p_{bm} = \frac{W_b}{V_s} = \eta_{thb} \times \eta_{vol} \times \rho_{air} \frac{1}{\alpha} LCV$$

that is

$$p_{bm} = 0.35 \times 0.80 \times 1.201 \times \frac{1}{15} \times 44000 = 986.42 \text{ kPa} = 9.9 \text{ bar}$$

The brake specific fuel consumption is:

$$bsfc = \frac{m_{fuel}}{W_b} = \frac{1}{\eta_{thb}} \times \frac{1}{LCV} = \frac{1}{0.35} \times \frac{1}{44 \times 10^6} = 6.49 \times 10^{-8} \text{ kg} \cdot \text{J}^{-1} = 0.234 \text{ kg} \cdot (\text{kWh})^{-1}$$

B)

The work per cycle, that is in a 4-stroke engine per four strokes is

$$W_{cycle} = p_{bm} V_s$$

the work per revolution that is per two strokes is (equation 6.2)

$$W_{rev} = 2\pi\tau$$

Hence

$$\tau = \frac{W_{rev}}{2\pi} = \frac{\frac{W_{cycle}}{2}}{2\pi} = \frac{W_{cycle}}{4\pi} = \frac{9.9 \times 10^5 \times 2 \times 10^{-3}}{4\pi} = 157 \text{ N} \cdot \text{m}$$

c)

The brake power is

$$\dot{W} = \tau \cdot \Omega = \tau \cdot 2\pi \frac{N}{60} = 157 \times 2 \times \pi \frac{3000}{60} = 49.3 \text{ kW}$$

D)

In previous condition the air was occupying a volume $V_a = V_s$ now as it is mixed with natural gas it occupies a volume V'_a and the gas a volume $V'_g = \frac{V'_a}{10}$ and the mixture of the two gases fills in previous volume V_a :

$$V_s = V_a = V'_a + V'_g = 1.1V'_a$$

hence $V'_a = \frac{1}{1.1}V_a$ and the new volumetric efficiency is

$$\eta'_{vol} = \frac{m'_a}{\rho_a V_s} = \frac{\rho_a V'_a}{\rho_a V_s} = \frac{\rho_a V_a \frac{1}{1.1}}{\rho_a V_s} = \frac{1}{1.1} \eta_{vol} = \frac{0.8}{1.1} \simeq 0.73$$

Exercises of Chapter 7

Exercise §7.1.1

A-I)

From equation (7.2)

$$\eta_c = 1 - \frac{1}{r_v^{\gamma-1}} = 1 - \frac{1}{10^{1.4-1}} = 0.602$$

A-II)

We have

$$\frac{T_2}{T_1} = \left(\frac{V_1}{V_2}\right)^{\gamma-1} = r_v^{\gamma-1} = \left(\frac{V_4}{V_3}\right)^{\gamma-1} = \frac{T_3}{T_4}$$

$$\text{and } \begin{cases} p_1 V_1 = n^R R T_1 \\ p_2 V_2 = n^R R T_2 \\ p_3 V_2 = n^P R T_3 \\ p_4 V_1 = n^P R T_4 \end{cases}$$

Here we are using air throughout the cycle: $n^P = n^R$ and $\frac{p_1 V_1}{p_3 V_2} = \frac{T_1}{T_3}$ that yields

$$T_3 = T_1 \frac{p_3}{p_1} \times \frac{V_2}{V_1} = T_1 \frac{p_3}{p_1} \times \frac{1}{r_v} = 300 \times \frac{100}{1} \times \frac{1}{10} = 3000 \text{ K}$$

A-III)

$$T_2 = T_1 r_v^{\gamma-1} = 300 \times 10^{0.4} = 753.6 \text{ K}$$

the specific heat is then

$$\dot{q}_{2-3} = c_v(T_3 - T_2) = 0.7178 \times (3000 - 753) = 1612 \text{ kJ.kg}^{-1}$$

A-IV)

$$T_4 = \frac{T_3}{r_v^{\gamma-1}} = \frac{3000}{10^{0.4}} = 1194 \text{ K}$$

and

$$\frac{p_3}{p_4} \times \frac{v_2}{v_1} = \frac{T_3}{T_4}$$

yields

$$p_4 = \frac{T_4}{T_3} \times \frac{v_2}{v_1} \times p_3 = \frac{1194}{3000} \times \frac{1}{10} \times 100 = 3.98 \text{ bar}$$

A-V)

$$p_m V_s = W = \eta_c Q = \eta_c m_1 q = \eta_c q V_s \rho_1$$

Hence

$$p_m = \eta_c q \rho_1$$

for ρ_1 use the equation of states for ideal gas

$$\tilde{v}_1 = \tilde{R} \frac{T_1}{p_1} = 8.3145 \times \frac{300}{10^5} = 0.0249 \text{ m}^3 \cdot \text{mol}^{-1}$$

and

$$\rho_1 = \frac{1}{v_1} = \frac{\tilde{m}}{\tilde{v}_1} = \frac{29 \times 10^{-3}}{0.0249} = 1.16 \text{ kg} \cdot \text{m}^{-3}$$

or use table Rogers & Mayhew (1998) page 16 ($\rho_1 = 1.177$) then

$$p_m = 0.602 \times 1612 \times 10^3 \times 1.16 \text{ Pa} = 11.28 \text{ bar}$$

B)

From previous section $T_2 = 754 \text{ K}$ and $T_3 = 3000 \text{ K}$, $T_{1-2} = \frac{754+3000}{2} = 1877 \text{ K}$. From tables page 16 at 1 bar, $\gamma = 1.301$ and $c_v = 0.9534 \text{ kJ} \cdot \text{kg}^{-1} \cdot \text{K}^{-1}$

i)

$$\eta_c = 1 - \frac{1}{r_v^{\gamma-1}} = 1 - \frac{1}{10^{0.3}} = 49.9\%$$

iii)

$$Q_{2-3} = c_v(T_3 - T_2) = 0.9534 \times 10^{-3}(3000 - 754) = 2142 \text{ kJ}$$

c)

From tables page 21

$$\Delta \tilde{h}^\ominus = -5\,116\,180 \text{ kJ} \cdot \text{kmol}^{-1}$$

at 298 K, octane reaction is

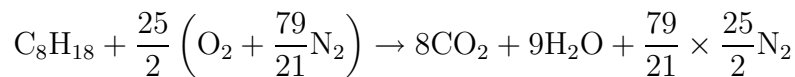

Hence for each kmol of fuel there is 12.5 kmol of O_2 that is $12.5 \times \frac{1}{0.21} = 59.52 \text{ kmol}$ of air

$$59.52 \times \tilde{m}_{air} = 59.52 \times 29 = 1726.2 \text{ kg of air per kmol of fuel}$$

the energy delivered per kmol of fuel is

$$\Delta h = \frac{\Delta \tilde{h}^\ominus}{1726.2} = 2964 \text{ kJ} \cdot \text{kg}^{-1} \text{ of air}$$

Exercises of Chapter 8

Exercise §8.8.1

$$\mathcal{V}_{pmax} = \frac{1 \text{ stroke}}{\text{time to do 1 stroke}} = \underbrace{S}_{\substack{1 \text{ stroke per} \\ \text{half revolution}}} \underbrace{N \times 2}_{\substack{\text{number of} \\ \text{half revolution} \\ \text{per 2 strokes}}}$$

with S the strokes and N in rev.s^{-1} .

Furthermore for \mathcal{V}_{mean} the piston mean velocity:

$$\mathcal{V}_{pmax} = 1.62 \times \mathcal{V}_{mean} = 1.62 \times 2 \times NS = 3.24 NS$$

Continuity (mass conservation) requires

$$A_p \mathcal{V}_p = \underbrace{A_{ef}}_{\text{effective area}} \mathcal{V}_v = C_D A_g \mathcal{V}_v$$

at any time. In particular at the discharge \mathcal{V}_p and \mathcal{V}_v are maximum:

$$A_p \mathcal{V}_{pmax} = A_{ef} (\mathcal{V}_v)_{disch}$$

From Bernoulli on the valve we have

$$p_1 + 0 = p_2 + \frac{1}{2} \rho \mathcal{V}_2^2$$

or

$$\Delta p = \frac{1}{2} \rho \mathcal{V}_2^2$$

with $\rho(1 \text{ bar}, 300 \text{ K}) = 1.177$. Hence on the valve

$$(\Delta p)_{disch} = \frac{1}{2} \rho (\mathcal{V}_v^2)_{disch}$$

so that

$$\mathcal{V}_{pmax} = 3.24 \times NS = C_D \frac{A_g}{A_p} (\mathcal{V}_v^2)_{disch} = C_D \frac{A_g}{A_p} \sqrt{\frac{2\Delta p}{\rho}}$$

Hence

$$N = \frac{1}{3.3} \times \frac{C_D A_g}{S A_p} \text{sqrt} \frac{2\Delta p}{\rho}$$

in rev.s^{-1}

$$N = 18.52 \times \frac{C_D A_g}{S A_p} \text{sqrt} \frac{2\Delta p}{\rho}$$

in rev.min^{-1}

- $N' = 4438 \text{ rev.min}^{-1}$ for $\frac{A_g}{A_p} = 0.2$ and
- $N' = 5770 \text{ rev.min}^{-1}$ for $\frac{A_g}{A_p} = 0.26$

Exercises of Chapter 10

Exercise §10.3.6

For $0 < \lambda < 0.3$, the scavenging process is perfect displacement:

$$\eta_{ch} = \lambda$$

and this fixes the boundary condition $\eta_{ch} = 0.3$ for $\lambda = 0.3$

90 % of further fresh charge is mixing scavenge $d\eta_{ch} = d\lambda(1 - \eta_{ch})$ and the 10% remaining is short-circuit $d\eta_{ch} = 0$ so the total charge efficiency increment is

$$d\eta_{ch} = 0.9d\lambda(1 - \eta_{ch})$$

that is

$$d\lambda = \frac{d\eta_{ch}}{0.9(1 - \eta_{ch})}$$

which can be integrated from $\lambda_I = 0.3$ to λ

$$\lambda - \lambda_I = \int_{\eta_{chI}}^{\eta_{ch}} \frac{d\eta_{ch}}{0.9(1 - \eta_{ch})} = -\frac{1}{0.9} \ln \left(\frac{1 - \eta_{ch}}{1 - \lambda_I} \right)$$

or

$$1 - \eta_{ch} = e^{-0.9(\lambda - \lambda_I)}(1 - \lambda_I)$$

that is with $\lambda_I = 0.3$

$$\eta_{ch} = 1 - 0.7 \times e^{0.9 \times 0.3} \times e^{-0.9\lambda} = 1 - 0.917 \times e^{-0.9\lambda}$$

For a unit scavenge ratio $\lambda = 1$

$$\eta_{ch} = 1 - 0.7 \times e^{0.9 \times 0.3} \times e^{-0.9 \times 1} = 0.627$$

For mixing scavenge throughout

$$\eta_{ch} = 1 - e^{-\lambda} = 1 - e^{-1} = 0.632$$

Exercise §10.4.1

A)

The work lost in the port is

$$W = \int V dp = V_t \Delta p \simeq V_s \Delta p$$

the actual work lost by the compressor of efficiency η_c is

$$W_c = \frac{W}{\eta_c} \approx V_s \frac{\Delta p}{\eta_c}$$

and terms of mean effective pressure

$$p_{lost} = \frac{W_c}{V_s} = \frac{\Delta p}{\eta_c} = \frac{0.25}{0.85} = 0.29 \text{ bar}$$

B)

According to exercise §10.3.6

$$\eta_{ch} = 1 - 0.917 \times e^{-0.9\lambda}$$

or

$$\lambda = -\frac{1}{0.9} \ln \left(\frac{1 - \eta_{ch}}{0.917} \right)$$

that is for $\eta_{ch} = 0.8$, $\lambda = 1.69$. If we can neglect density change and $\Delta p \sim \lambda^2$ we can use relation (10.5):

$$p_{lost} = \frac{W_c}{V_s} = c\lambda^3$$

where c can be deduced from a)

$$p_{lost} = \frac{0.29}{1^3} \times 1.69^3 = 1.4 \text{ bar}$$

Neglecting density change seems a strong assumption with $\Delta p = 1.4$

Exercises of Chapter 11

Exercise §??

A)

Use equation (11.7) with $r \ll 1$

$$p'_{em} = \frac{W'_{max}}{V_s} \simeq p_0 \left[1 + \frac{1}{\gamma - 1} \left(\frac{p_4}{p_0} \right) - \frac{\gamma}{\gamma - 1} \left(\frac{p_4}{p_0} \right)^{\frac{1}{\gamma}} \right]$$

Exercises of Chapter 12

Exercise §12.6

A)

$$\begin{cases} p_{em} &= a\rho_a \\ p_e &= bp_a \\ T_e &= cT_a \end{cases}$$

At 30°C, 1 bar $\rho_a = 1.177 \text{ kg.m}^{-3}$ (table Rogers & Mayhew (1998) page 16), hence

$$\begin{cases} a &= \frac{p_{em}}{\rho_a} = \frac{10}{1.177} = 8.5 \text{ bar.m}^3.\text{kg}^{-1} \\ b &= \frac{p_e}{p_a} = \frac{3.5}{1} = 3.5 \\ c &= \frac{T_e}{T_a} = \frac{800+273}{30+273} = 3.54 \end{cases}$$

Now the inlet pressure of the cylinder is $p_a = 1.8 \text{ bar}$, use relations (11.3) and (11.6) to find the temperature after the compressor that is the temperature in the cylinder.

$$\eta_c = \frac{T_{as} - T_0}{T_a - T_0}$$

with $\frac{T_{as}}{T_0} = \left(\frac{p_a}{p_0}\right)^{\frac{\gamma_a-1}{\gamma_a}}$, hence

$$\eta_c = \frac{T_0 \left[\left(\frac{p_a}{p_0}\right)^{\frac{\gamma_a-1}{\gamma_a}} - 1 \right]}{T_a - T_0}$$

and

$$T_a = T_0 \left\{ 1 + \frac{1}{\eta_c} \left[\left(\frac{p_a}{p_0}\right)^{\frac{\gamma_a-1}{\gamma_a}} - 1 \right] \right\} = 303 \times \left\{ 1 + \frac{1}{0.7} \left[\left(\frac{1.8}{1}\right)^{\frac{1.4-1}{1.4}} - 1 \right] \right\} = 382.2 \text{ K}$$

from ideal gas equation before and after the compressor we get $\frac{p_0}{p_a} \frac{\rho_a}{\rho_0} = \frac{T_0}{T_a}$ that is

$$\rho_a = \rho_0 \frac{T_0}{T_a} \frac{p_a}{p_0} = 1.177 \times \frac{303}{382.2} \times \frac{1.8}{1} = 1.68 \text{ kg.m}^{-3}$$

and

$$p_{iem} = 8.5 \times \rho_a = 8.5 \times 1.68 = 14.28 \text{ bar}$$

$$p_e = 3.5 \times p_a = 3.5 \times 1.8 = 6.3 \text{ bar}$$

at the turbine inlet the temperature is

$$T_e = 3.54 \times T_a = 3.54 \times 382.2 = 1353 \text{ K} = 1080^\circ\text{C}$$

B)

Power balance requires $W_t = W_c$ that is

$$c_{pa}(T_a - T_0) = c_{pe}(T_{e0} - T_e)$$

or

$$\frac{\gamma_a}{\gamma_a - 1} T_0 \frac{1}{\eta_c} \left[\left(\frac{p_a}{p_0} \right)^{\frac{\gamma_a - 1}{\gamma_a}} - 1 \right] = \frac{\gamma_g}{\gamma_g - 1} T_e \eta_t \left[\left(\frac{p_0}{p_{e'}} \right)^{\frac{\gamma_g - 1}{\gamma_g}} - 1 \right]$$

where $p_{e'}$ is the constant pressure in the exhaust manifold or at the turbine inlet, then

$$p_{e'} = p_0 \left\{ 1 - \frac{\gamma_a}{\gamma_a - 1} \frac{\gamma_g}{\gamma_g - 1} \frac{T_0}{T_e} \frac{1}{\eta_c \eta_t} \left[\left(\frac{p_a}{p_0} \right)^{\frac{\gamma_a - 1}{\gamma_a}} - 1 \right] \right\}^{\frac{\gamma_g}{1 - \gamma_g}}$$

that is

$$p_{e'} = 1 \times 10^5 \times \left\{ 1 - \frac{71}{24} \frac{303}{1353} \frac{1}{0.7 \times 0.7} \left[\left(\frac{1.8}{1} \right)^{-4} - 1 \right] \right\}^{-4} = 1.35 \times 10^5 \text{ Pa}$$

Exercise §12.7

A)

$$\Delta T = T_e - T_a = \frac{1200}{1 + 20} = 571 \text{ K}$$

For a perfect gas the compressor efficiency is

$$\eta_c = \frac{T_{sa} - T_0}{T_a - T_0}$$

with T_{sa} the isentropic temperature. Hence

$$T_a = T_0 + \frac{1}{\eta} (T_{sa} - T_0) = T_0 \left[1 + \frac{1}{\eta} \left(\left(\frac{p_a}{p_0} \right)^{\frac{\gamma - 1}{\gamma}} - 1 \right) \right] = 293 \times \left[1 + \frac{1}{0.75} \left(\left(\frac{1.6}{1} \right)^{\frac{2}{7}} - 1 \right) \right] = 349 \text{ K}$$

Hence turbine inlet temperature is $T_e = T_a + \Delta T = 349 + 571 = 920$ K..

The actual work in the compressor is

$$W_c = \frac{m_a}{\eta_c} c_{pa} T_0 \left[\left(\frac{p_a}{p_0} \right)^{\frac{\gamma-1}{\gamma}} - 1 \right]$$

and the turbine efficiency is for a perfect gas

$$\eta_t = PF \times \eta_{ts} = \frac{T_{e0} - T_e}{T_{eos} - T_e} = \frac{W_t}{W_{ts}}$$

and the actual work from the turbine is

$$W_t = \eta_t m_e c_{pe} T_e \left[1 - \left(\frac{p_0}{p_e} \right)^{\frac{\gamma_e-1}{\gamma_e}} \right]$$

with $m_e = m_a + m_f = (1 + f)m_a$. The turbine provides the work for the compressor, $W_t = W_c$:

$$m_a \eta_t (1 + f) \frac{\gamma_e R}{\gamma_e - 1} T_e \left[1 - \left(\frac{p_0}{p_e} \right)^{\frac{\gamma_e-1}{\gamma_e}} \right] = m_a \frac{\gamma_a R}{\gamma_a - 1} (T_a - T_0)$$

Hence

$$T_e \left[1 - \left(\frac{p_0}{p_e} \right)^{\frac{\gamma_e-1}{\gamma_e}} \right] = \frac{\gamma_a (\gamma_e - 1)}{\gamma_e (\gamma_a - 1)} (T_a - T_0) \frac{1}{\eta_t (1 + f)}$$

therefore

$$\frac{p_0}{p_e} = \left[1 - \frac{\gamma_a (\gamma_e - 1)}{\gamma_e (\gamma_a - 1)} \left(\frac{T_a}{T_e} - \frac{T_0}{T_e} \right) \frac{1}{\eta_t (1 + f)} \right]^{\frac{\gamma_e}{\gamma_e - 1}}$$

or

$$p_e = p_0 \left[1 - \frac{\gamma_a (\gamma_e - 1)}{\gamma_e (\gamma_a - 1)} \left(\frac{T_a}{T_e} - \frac{T_0}{T_e} \right) \frac{1}{\eta_t (1 + f)} \right]^{\frac{-\gamma_e}{\gamma_e - 1}} \quad (15.7)$$

That is

$$p_e = 1 \times 10^5 \times \left[1 - \frac{7}{2} \times \frac{1}{4} \times \left(\frac{349}{920} - \frac{293}{920} \right) \times \frac{1}{0.65 \times 1.2 \times \left(1 + \frac{1}{20} \right)} \right]^{-4} = 1.31 \times 10^5 \text{ Pa}$$

B)

We still have

$$T_a = T_0 + \frac{1}{\eta_c} (T_{sa} - T_0) = T_0 \left[1 + \frac{1}{\eta_c} \left(\left(\frac{p_a}{p_0} \right)^{\frac{\gamma_a-1}{\gamma_a}} - 1 \right) \right]$$

but now $p_0 = 0.8$, $\eta_c = 0.7$, hence,

$$T_a = 293 \times \left[1 + \frac{1}{0.7} \left(\left(\frac{1.6}{0.8} \right)^{\frac{2}{7}} - 1 \right) \right] = 384.7 \text{ K}$$

The air mass flow is proportional to compressed air density:

$$\left. \begin{array}{l} \text{at } p_0 = 1 \text{ bar} \quad \alpha = \frac{m_a}{m_f} \\ \text{at } p_0 = 0.8 \text{ bar} \quad \alpha' = \frac{m'_a}{m_f} \end{array} \right\} \text{hence } \frac{\alpha'}{\alpha} = \frac{m'_a}{m_a} = \frac{\rho'_a}{\rho_a} = \frac{p'_a}{T'_a} \times \frac{T_a}{p_a} = \frac{T_a}{T'_a} = \frac{349}{384.7} = 0.907$$

(since $p_a = p'_a = 1 \text{ bar}$) then

$$T'_e = T'_a + \Delta T' = T'_a + \frac{1200}{1 + \alpha'} = T'_a + \frac{1200}{1 + 0.907 \times \alpha} = 384.7 + \frac{1200}{1 + 0.907 \times 20} = 1012 \text{ K}$$

and relation (15.7) is still valid:

$$p_e = 0.8 \times 10^5 \times \left[1 - \frac{7}{2} \times \frac{1}{4} \times \left(\frac{384.7}{1012} - \frac{293}{1012} \right) \times \frac{1}{0.6 \times 1 \times \left(1 + \frac{1}{18.14} \right)} \right]^{-4} = 1.366 \times 10^5 \text{ Pa}$$

References

- BECK, S. B. M. 2000 *MEC 108: Heat, Work and Energy*. First year notes, Mechanical Engineering, The University of Sheffield.
- BOAS, M. L. 2005 *Mathematical Methods in the Physical Sciences*, 3rd edn. Wiley.
- CENGEL, Y. A. & BOLES, M. A. 1998 *Thermodynamics An Engineering Approach*, 3rd edn. Mc Graw Hill.
- COHEN, H., ROGERS, G. F. C. & SARAVANAMUTTOO, H. I. H. 1999 *Gas Turbine Theory*, 4th edn.
- FERGUSON, C. R. 1986 *Internal Combustion Engines Applied Thermosciences*. John Wiley & Sons.
- FLYNN, P. F., DURRETT, R. P., HUNTER, G. L., ZUR LOYE, A. O. & AKINYEMI, O. C. 1999 Diesel Combustion: An integrated View Combining Laser Diagnostics, Chemical Kinetics, and Empirical Validation. *SAE paper Series 1999-01-0509* .
- HEYWOOD, J. B. 1988 *Internal combustion engine fundamentals*. MacGraw-Hill.
- HEYWOOD, J. B. & SHER, E. 1999 *The Two-Stroke Cycle Engine*. Taylor & Francis.
- LUMLEY, J. 1999 *Engines an introduction*. Cambridge University Press.
- NAYLER, G. H. F. 1985 *Dictionary of Mechanical Engineering*, 4th edn.
- NICOLLEAU, F. 1994 Processus fractals et réaction chimique en milieux turbulents. PhD thesis, Ecole Centrale de Lyon.
- NICOLLEAU, F. 2001 *MEC310 Energy properties and optimisation*. Department of Mechanical Engineering the University of Sheffield.
- NICOLLEAU, F. & MATHIEU, J. 1994 Eddy Break Up Model and Fractal Theory - Comparisons with Experiments. *Int. J. Heat Mass Transfer*. **37** (18), 2925–2933.
- PETERS, N. 2000 *Turbulent Combustion*. Cambridge University Press.
- ROGERS, G. F. C. & MAYHEW, Y. R. 1998 *Thermodynamic and transport properties of fluids*, 5th edn. Blackwell.

SMYTH, R. 1999 *Thermodynamics and Heat Transfer*. Mechanical Engineering, University of Sheffield: Second year notes, Mechanical Engineering, The University of Sheffield.

STONE, R. 1999 *Introduction to Internal Combustion Engines*, 3rd edn.

